

3-7 Tiny Serial-to-Ethernet Device Server & Modbus Gateway

tDS-700 Series

Tiny Serial-to-Ethernet Device Server



tDS-712 tDS-700 series tDSM-712



Features >>>

- Incorporates any RS-232/422/485 serial device in Ethernet
- Application Modes: Virtual COM, TCP Server, TCP Client
- Virtual COM for 32/64-bit Windows XP/2003/2012/7/8/10
- Data Packing Modes: Length, Delimiter, timeout, Char-timeout.
- Supports pair-connection (serial-bridge, serial-tunnel) applications
- Supports UDP responder for device discovery (UDP Search)
- Static IP or DHCP network configuration
- Easy firmware update via the Ethernet (BOOTP, TFTP)
- Tiny Web server for serial and network configuration (HTTP)
- Contains a 32-bit MCU that efficiently handles network traffic
- 10/100 Base-TX Ethernet, RJ-45 x 1 (Auto-negotiating, auto MDI/MDIX, LED Indicators)
- Redundant power inputs: PoE and DC jack
- Allows automatic RS-485 direction control
- 2500 V_{DC} isolation and +/-4 kV ESD protection for i versions
- tDSM-712 is the tDS-712 with Metal Case
- Male DB-9 or terminal block connector for easy wiring
- Tiny form-factor and low power consumption
- RoHS compliant & no Halogen
- Cost-effective device servers

Introduction

The tDS-700 is a series of Serial-to-Ethernet device servers designed to add Ethernet and Internet connectivity to any RS-232 and RS-422/485 device, and to eliminate the cable length limitation of legacy serial communication. By using the VxComm Driver/Utility, the built-in COM port of the tDS-700 series can be virtualized to a standard PC COM port in Windows. Therefore, users can transparently access or monitor serial devices over the Internet/Ethernet without software modification.

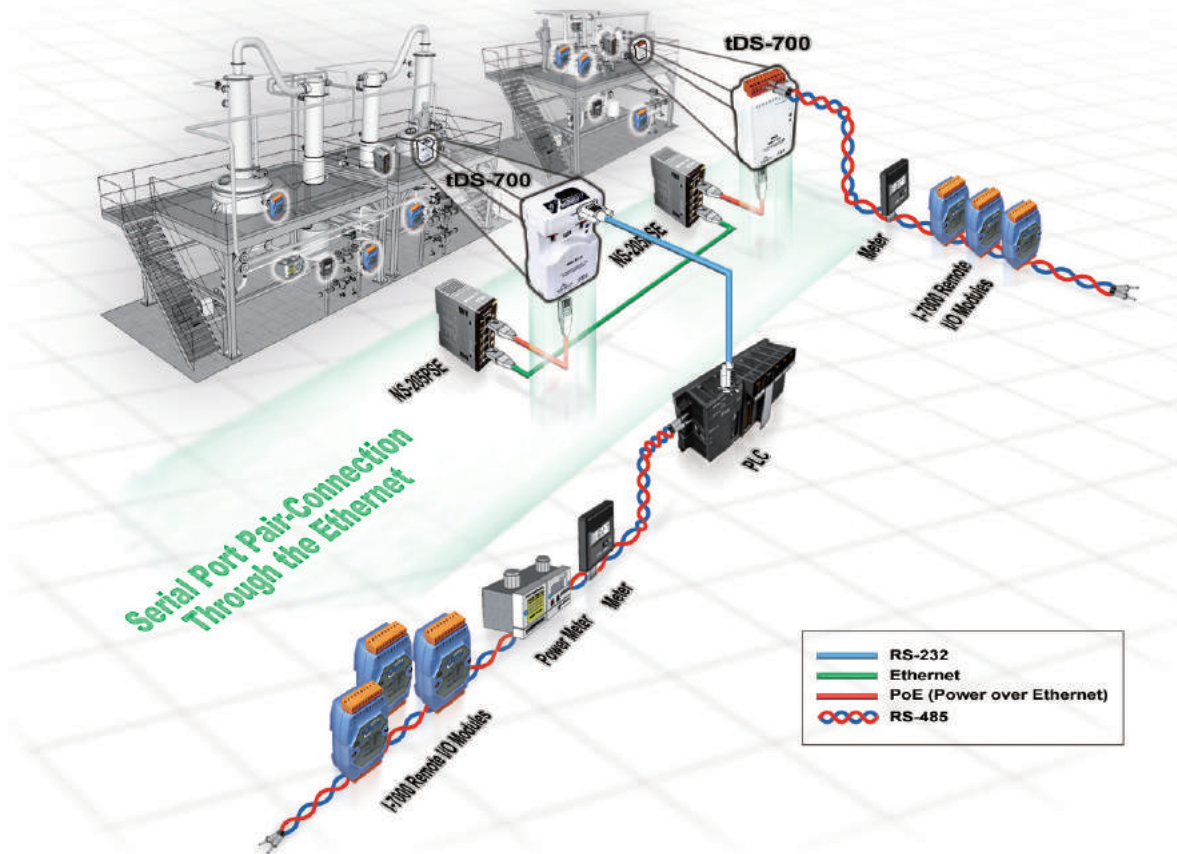

The VxComm Driver/Utility supports the most popular operating system in the world, including 32-bit and 64-bit Windows 10/8/7/Vista/2008/2003/XP. The virtual COM works transparently and is protocol independent, enabling perfect integration with your current central computer. The utility provides an easy configuration interface that can be used to quickly create and map virtual COM ports to one or several tDS-700 modules. In addition, the utility contains a built-in terminal program, so users can send/receive command/data via the terminal program for easy testing.

The tDS-700 device servers can be used to create a pair-connection application (as well as serial-bridge or serial-tunnel), and can then route data over TCP/IP between two serial devices, which is useful when connecting mainframe computers, servers or other serial devices that do not themselves have Ethernet capability. By virtue of its protocol independence and flexibility, the tDS-700 meets the demands of virtually any network-enabled application.

DHCP minimizes configuration errors caused by manual IP address configuration, such as address conflicts caused by the assignment of an IP address to more than one computer or device at the same time. The tDS-700 supports the DHCP client function, which allows the tDS-700 to easily obtain the necessary TCP/IP configuration information from a DHCP server. The tDS-700 also contains a UDP responder that transmits its IP address information in response to a UDP search from the VxComm Utility, making local management more efficient.

The tDS-700 features a powerful 32-bit MCU to enable efficient handling of network traffic. It also has a built-in web server that provides an intuitive web management interface to allow users to modify the settings of the module, including DHCP/Static IP, gateway/mask and serial ports.

Based on an amazing tiny form-factor, the tDS-700 achieves the maximum space savings that allows it to be easily installed anywhere, even directly attached to a serial device or embedded into a machine.

The tDS-700 series also contains a built-in CPU watchdog, which automatically resets the CPU if the built-in firmware is operating abnormally, or if there is no communication between the tDS-700 and the host for a predefined period of time (system timeout). This is an important feature that ensures the tDS-700 operates continuously, even in harsh environments.



The tDS-700 offers true IEEE 802.3af-compliant (classification, Class 1) Power over Ethernet (PoE) functionality using a standard category 5 Ethernet cable to receive power from a PoE switch such as the NS-205PSE. If there is no PoE switch on site, the tDS-700 will also accept power input from a DC adapter. The tDS-700 is designed for ultra-low power consumption, reducing hidden costs from increasing fuel and electricity prices, especially when you have a huge amount of device servers installed. Reducing the amount of electricity consumed by choosing energy-efficient equipment can have a positive impact on maintaining a green environment.

The tDS-712 is equipped with a male DB-9 connector, while other models are equipped with a removable terminal block connector to allow easy wiring, and also supports automatic RS-485 direction control when sending and receiving data.

The tDS-700 has the same basic Serial-to-Ethernet gateway and virtual COM functions as the PDS-700 series, as shown in the above comparison table. Note: For multiple TCP connections on the same serial port, use PDS-700 instead.

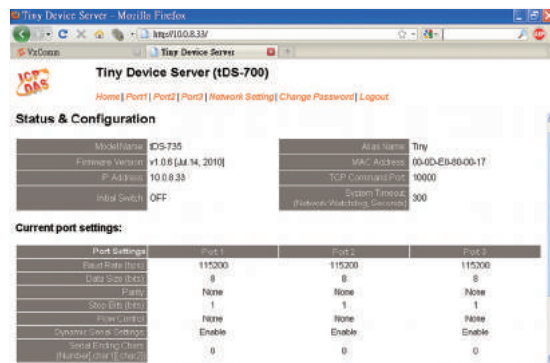
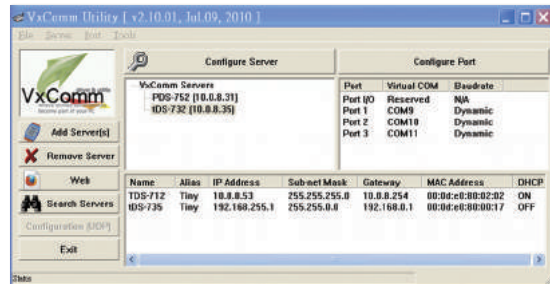

Comparison Table	tDS-700 Series	PDS-700 Series
Ethernet	10/100 M, PoE	10/100 M
Programmable	–	Yes
Virtual COM	Yes	Yes
Virtual I/O	–	Yes
DHCP	Yes	Yes
Web Configuration	Yes	Yes
UDP Search	Yes	Yes
Multi-client	–	Yes
Remarks	Cost-effective	–

Applications

- Factory Automation
- Home Automation

- Building Automation
- Remote Diagnosis and Management



1. Access serial device via Virtual COM ports

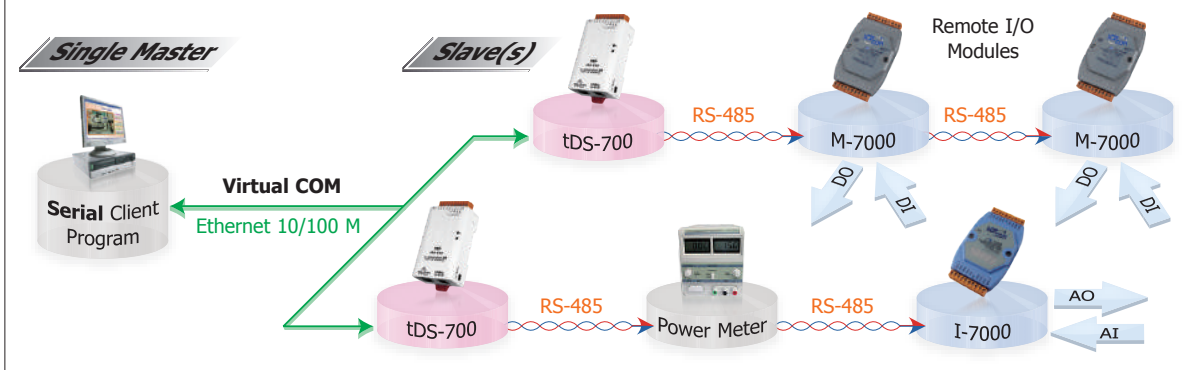

2. Access serial device via TCP/IP socket connection

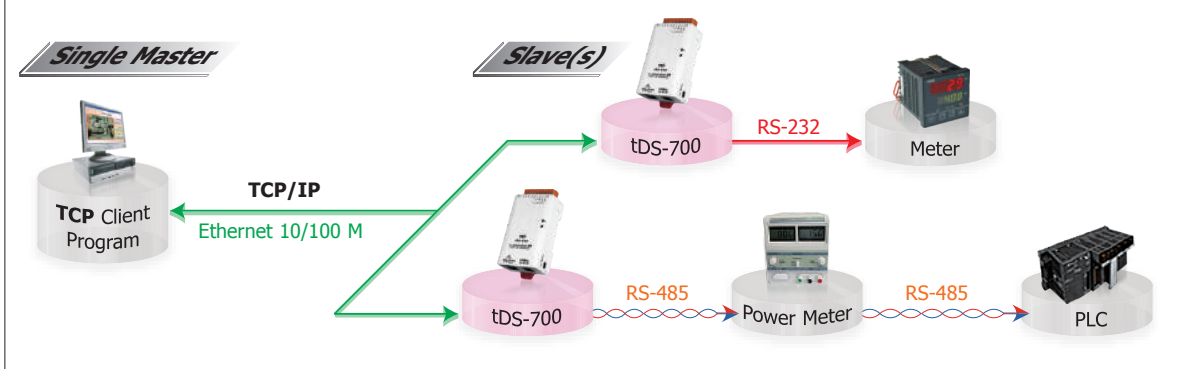

3. Serial converter application through pair-connection

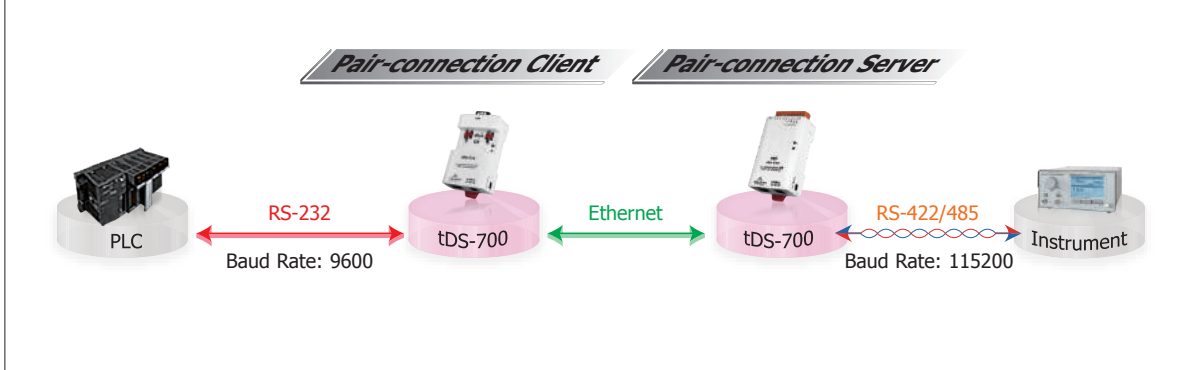

4. Virtual RS-485 bus application through pair-connection

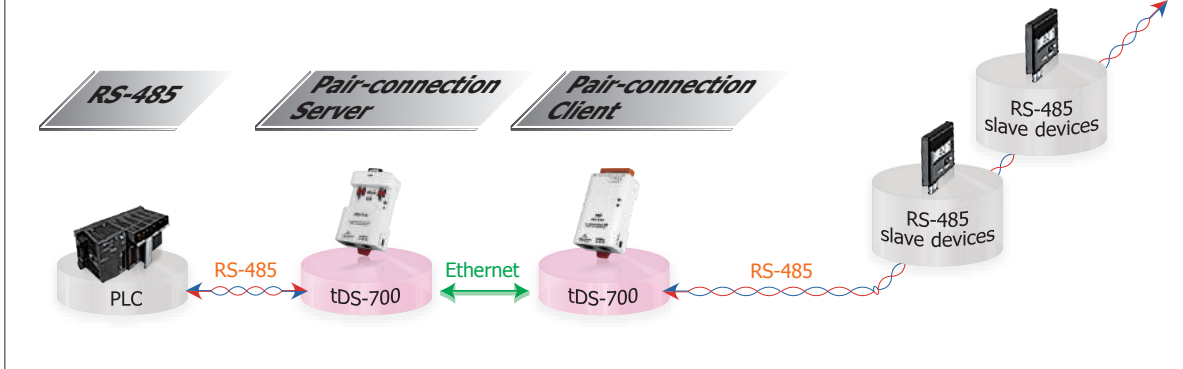

tGW-700 Series

Tiny Modbus/TCP to RTU/ASCII Gateway



tGW-712

tGW-700 series



Features ▶▶▶

- Supports Modbus TCP/UDP master and slave
- Supports Modbus RTU/ASCII master and slave
- Max. TCP connections (masters) per serial port: 32 (tGW-71x), 16 (tGW-72x) or 10 (tGW-73x)
- Read-cache ensures faster Modbus TCP/UDP response
- Supports UDP responder for device discovery (UDP Search)
- Static IP or DHCP network configuration
- Easy firmware update via the Ethernet (BOOTP, TFTP)
- Tiny Web server for serial and network configuration (HTTP)
- Redundant power inputs: PoE and DC jack
- 10/100 Base-TX Ethernet, RJ-45 x 1 (Auto-negotiating, auto MDI/MDIX, LED Indicators)
- Allows automatic RS-485 direction control
- 2500 V_{DC} isolation and +/-4 kV ESD protection for i versions
- Male DB-9 or terminal block connector for easy wiring
- Tiny form-factor and low power consumption
- RoHS compliant & no Halogen
- Cost-effective Modbus Gateway

Introduction

Modbus has become a de facto standard industrial communication protocol, and is now the most commonly available means of connecting industrial electronic devices. Modbus allows for communication between many devices connected to the same RS-485 network, for example, a system that measures temperature and humidity and communicates the results to a computer. Modbus is often used to connect a supervisory computer with a remote terminal unit (RTU) in supervisory control and data acquisition (SCADA) systems.

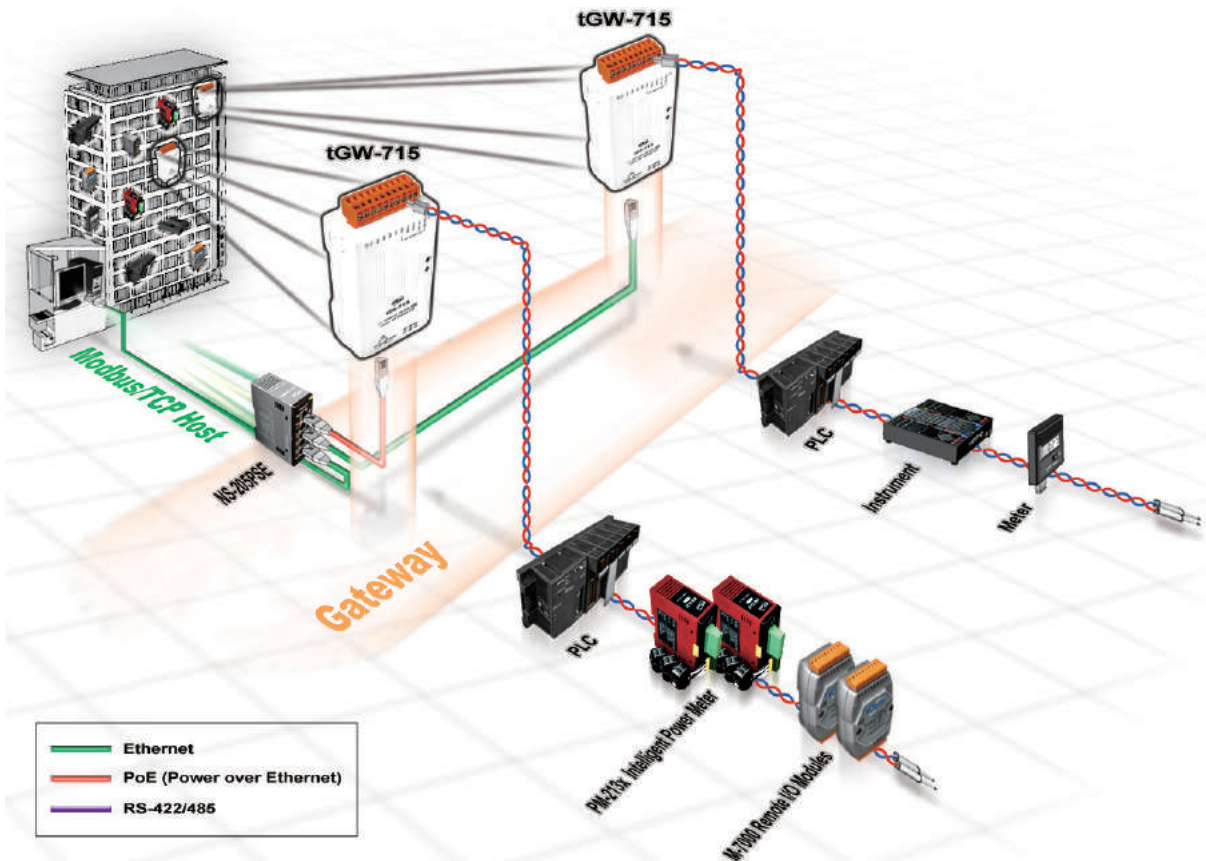

The tGW-700 module is a Modbus gateway that enables a Modbus TCP/UDP host to communicate with serial Modbus RTU/ASCII devices through an Ethernet network, and eliminates the cable length limitation of legacy serial communication devices. The module can be used to create a pair-connection application (as well as serial-bridge or serial-tunnel application), and can then route data over TCP/IP between two serial Modbus RTU/ASCII devices, which is useful when connecting mainframe computers, servers or other serial devices that use Modbus RTU/ASCII protocols and do not themselves have Ethernet capability.

The maximum number of TCP connections for each serial port is up to 32 for tGW-71x, 16 for tGW-72x and 10 for tGW-73x. This allows multiple masters accessing slave devices on the same serial port. The new read-cache function is used to store previous requests and responses in the memory buffer of the tGW-700 module. When other HMI/SCADA master controllers send the same requests to the same RTU slave device, the cached response is returned immediately. This feature dramatically reduces the loading on the serial port communication, ensures faster TCP responses, and improves the stability of the entire system.

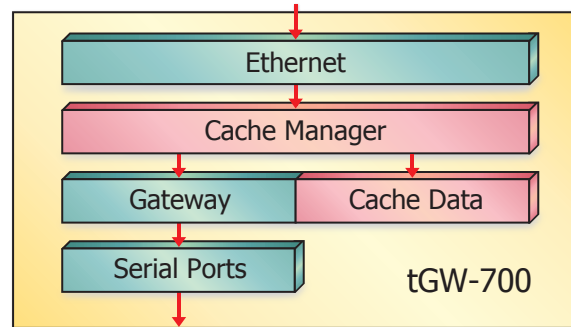

The tGW-700 module supports the DHCP client function, which allows it to easily obtain the necessary TCP/IP configuration information from a DHCP server, and minimizes configuration errors caused by manual setting. The module also contains a UDP responder that transmits its IP address information in response to a UDP search from the eSearch utility, making local management more efficient.

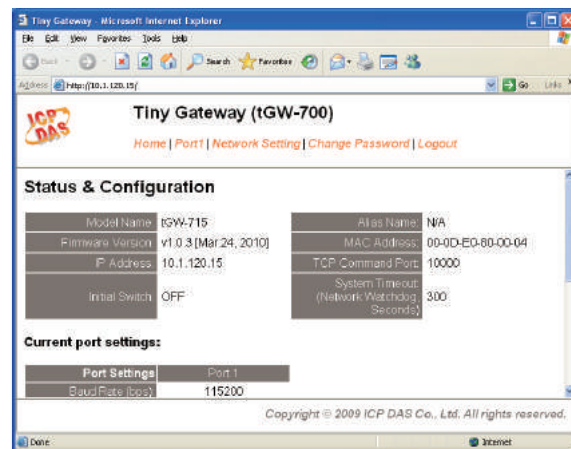

The tGW-700 module features a powerful 32-bit MCU to enable efficient handling of network traffic, and also has a built-in web server that provides an intuitive web management interface that allows users to modify the configuration of the module, including the DHCP/Static IP, the gateway/mask settings and the serial port settings.



The module contains a dual watchdog, including a CPU watchdog (for hardware functions) and a host watchdog (for software functions). The CPU watchdog automatically resets the CPU if the built-in firmware is operating abnormally, while the host watchdog automatically resets the CPU if there is no communication between the module and the host (PC or PLC) for a predefined period of time (system timeout). The dual watchdog is an important feature that ensures the module operates continuously, even in harsh environments.

The tGW-700 module offers true IEEE 802.3af-compliant (classification, Class 1) Power over Ethernet (PoE) functionality using a standard category 5 Ethernet cable to receive power from a PoE switch such as the NS-205PSE. If there is no PoE switch on site, the module will also accept power input from a DC adapter. The tGW-700 module is designed for ultra-low power consumption, reducing hidden costs from increasing fuel and electricity prices, especially when you have a large number of modules installed. Reducing the amount of electricity consumed by choosing energyefficient equipment can have a positive impact on maintaining a green environment.

Based on an amazing tiny form-factor, the tGW-700 achieves maximum space savings that allows it to be easily installed anywhere, even directly embedded into a machine. It also supports automatic RS-485 direction control when sending and receiving data, thereby improving the stability of the RS-485 communication.

Comparison Table	Ethernet	Programmable	Virtual COM	Virtual I/O	DHCP	Web Configuration	UDP Search	Modbus Gateway	Multi-client
tGW-700 Series	10/100 M, PoE	-	-	-	Yes	Yes	Yes	Yes	Yes
PPDS-700-MTCP Series	10/100 M, PoE	Yes	Yes	Yes	Yes	Yes	Yes	Yes	Yes

Applications

- Factory Automation
- Building Automation
- Home Automation
- Remote Diagnosis and Management



1. Modbus TCP to RTU/ASCII Gateway application

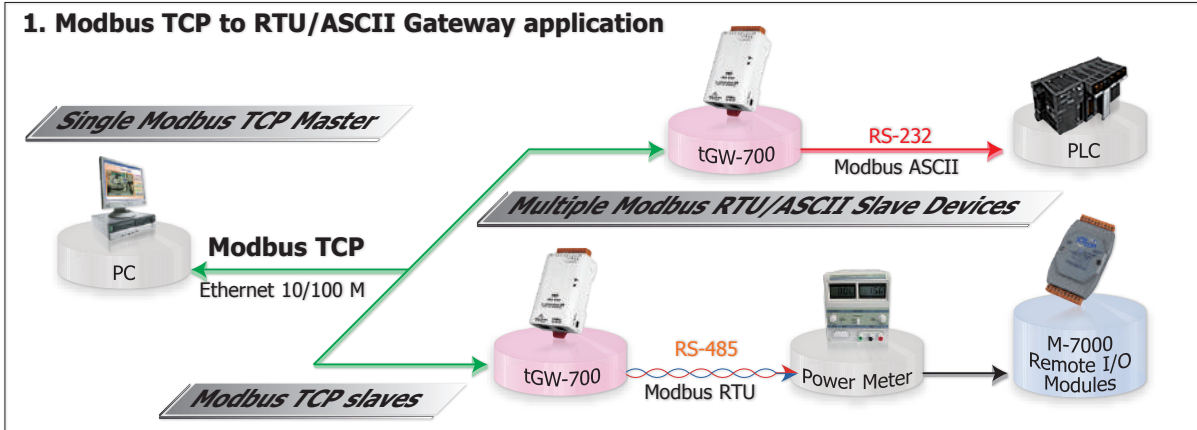

2. Modbus TCP to RTU/ASCII Gateway application (dual-port)

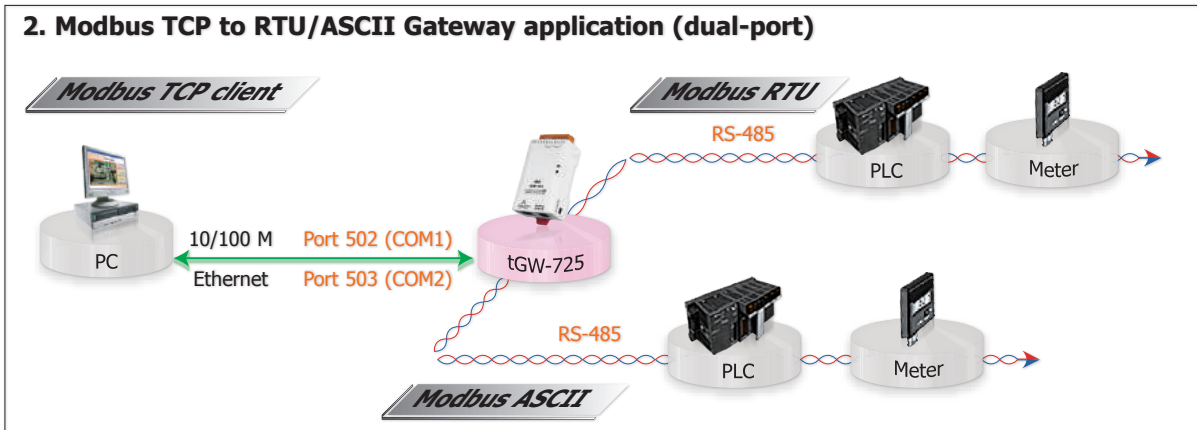

3. Modbus RTU/ASCII to TCP Gateway application (like pair-connection)

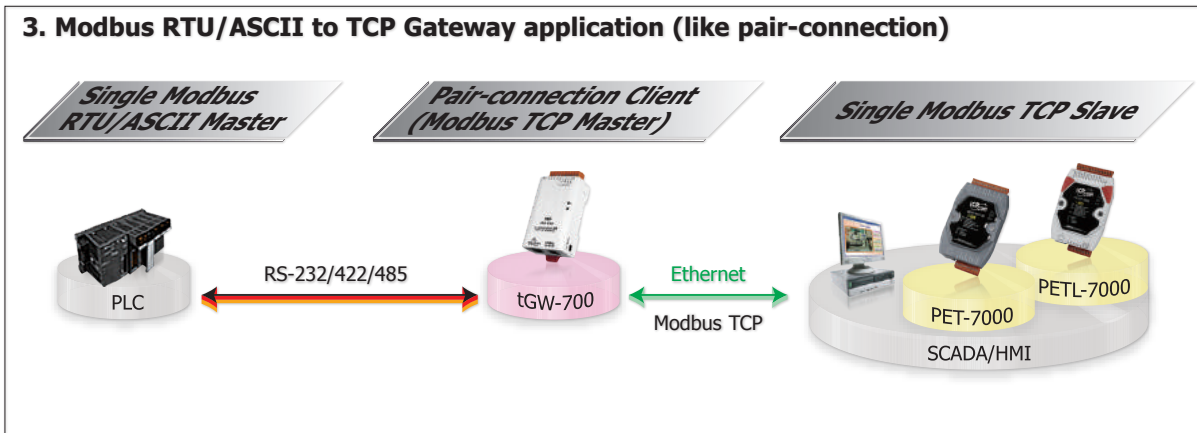

4. Virtual RS-485 bus application through pair-connection

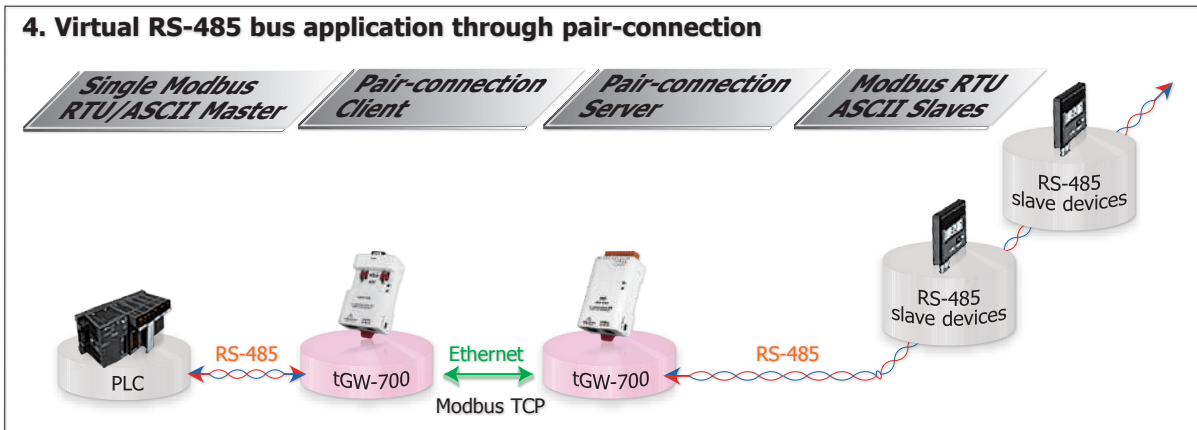

3
7
Serial Device Server

tSH-700 Series

Tiny Serial Port Sharer



tSH-700 series



Features ▶▶▶

- Supports baud rate conversion application
- Supports two masters sharing one slave port
- Read-cache ensures faster response
- Redundant power inputs: PoE and DC jack
- Tiny form-factor and low power consumption
- Supports Modbus RTU/ASCII protocol conversion
- Raw data mode for most query-response protocols
- Built-in web server for easy configuration (HTTP)
- Allows automatic RS-485 direction control
- 2500 V_{DC} isolation and +/-4 kV ESD protection for i versions

Introduction

Following the success of the original tGW-700/tDS-700 modules, ICP DAS has continued to develop new functions for these products in order to provide increased support for a greater number of applications. The tGW-700 modules are Modbus TCP-to-Serial gateway, while the tSH-700 modules are Serial Port Sharers working as Serial-to-Serial converters. The tSH-700 module provides a number of functions, including "Baud Rate Conversion", "Modbus RTU/ASCII Conversion" and "Two Masters Share One Slave". The built-in web server provides easy configuration interface, and no console commands are required.

• Baud Rate Conversion:

This function allows a single master device to communicate with slave devices using different baud rates and data formats. Most query-response protocols (half-duplex), e.g. DCON, are supported in the raw data mode. Full-duplex communication should also work when the data size is smaller than the built-in 512 bytes buffer on each serial port.



• Modbus RTU/ASCII Conversion:

This function allows a single Modbus RTU/ASCII master device to communicate with Modbus RTU/ASCII slave devices using different protocols, baud rates and data formats.



• Two Masters Share One Slave:

This function allows two master devices connected to different serial ports to share slave devices. The queries from the masters are queued in the tSH-700 module and then processed one-by-one. Modbus mode can be used to convert the Modbus RTU/ASCII protocols, while raw data mode can be used for DCON or other query-response protocols. Different baud rates and data formats can also be used on the different serial ports.

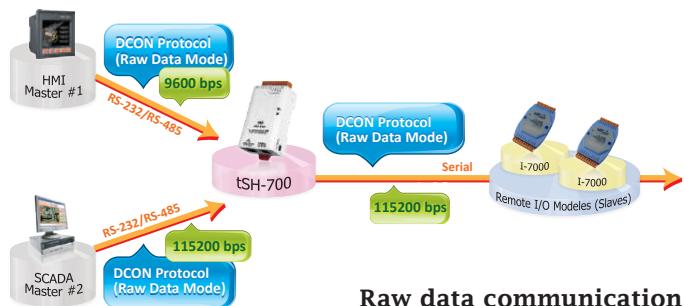

Raw data communication

• Read-Cache Function:

The built-in read-cache function is used to store previous requests and responses of the Modbus messages in the memory buffer of the tSH-700 module. When other HMI/SCADA master controllers requiring the same information from the same slave RTU device, the cached response is returned immediately. This feature dramatically reduces the loading on the slave serial port communication, ensures faster responses to the master, and improves the stability of the entire system.

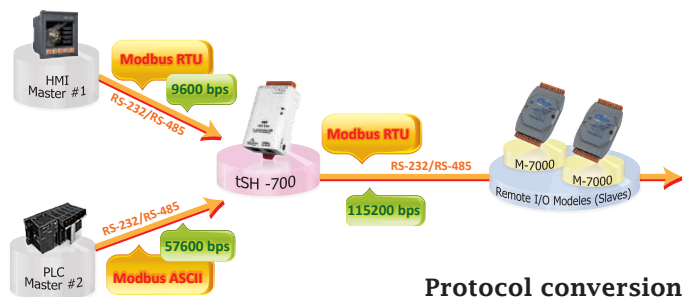

Protocol conversion

Applications

Accessing a Process Controller from Local Panel and Control Center

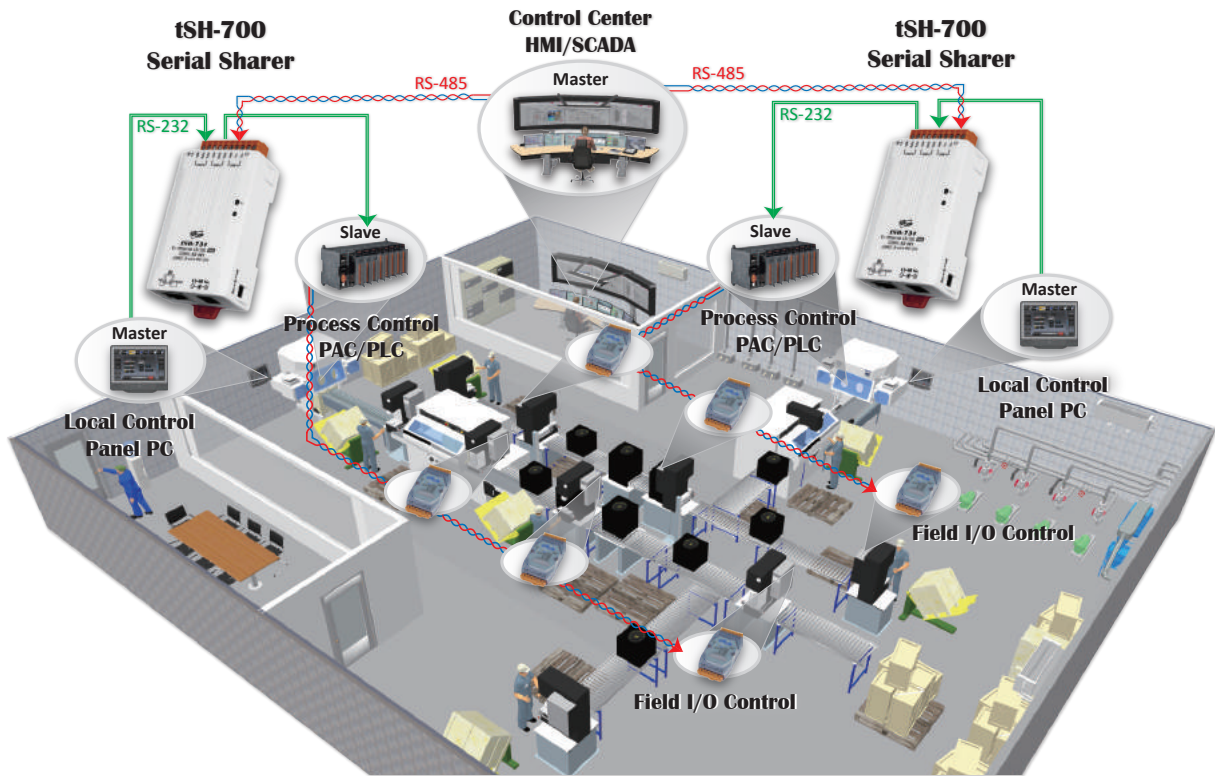

3
7
Serial Device Server

Control Office Lightings from Two HMI Devices (Masters) in Different Places

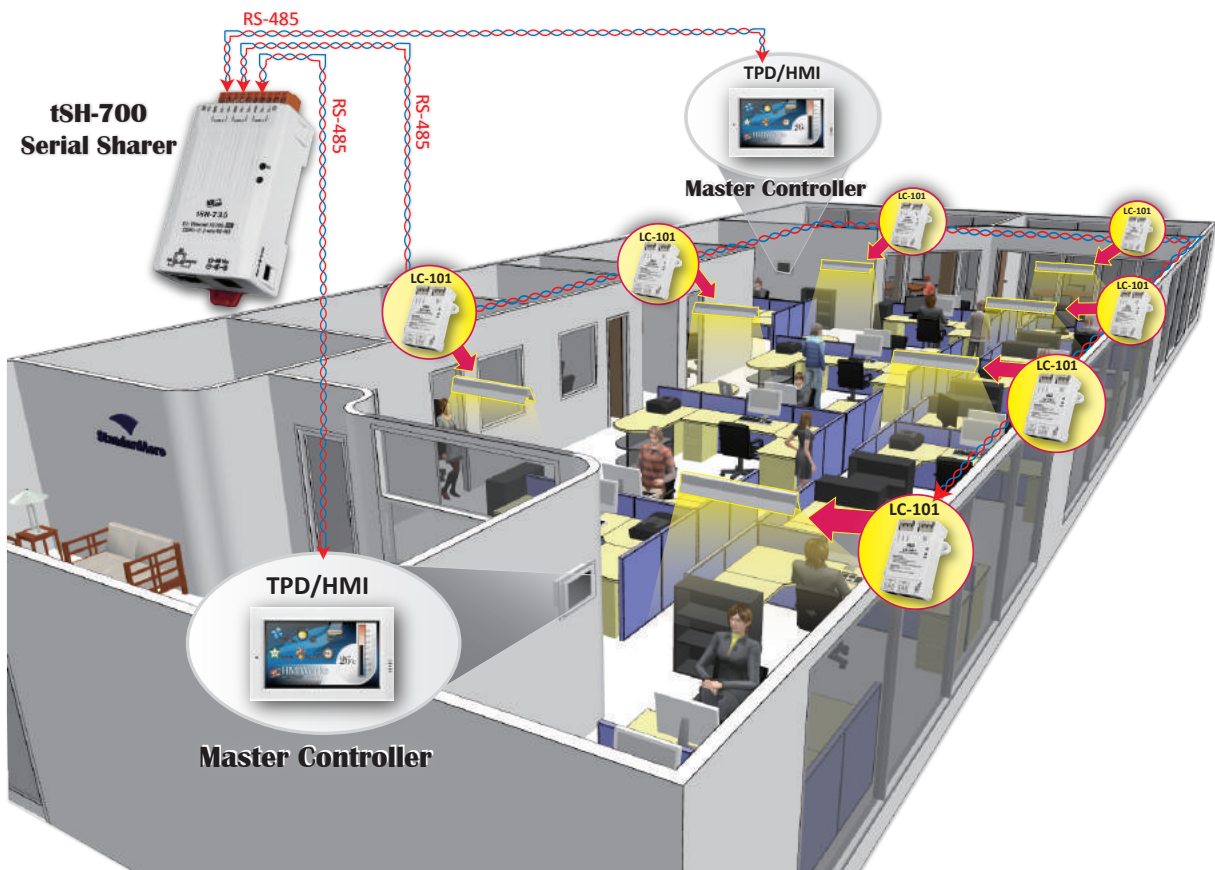

System Specifications

Models	tDS-712 tDS-712i tGW-712 tGW-712i	tDSM-712	tDS-722 tDS-722i tGW-722 tGW-722i tSH-722 tSH-722i	tDS-732 tDS-732i tGW-732 tGW-732i tSH-732 tSH-732i	tDS-715 tDS-715i tGW-715i	tDS-725 tDS-725i tGW-725i tSH-725 tSH-725i	tDS-735 tDS-735i tGW-735i tSH-735 tSH-735i	tDS-718 tDS-718i tGW-718 tGW-718i	tDS-724 tDS-724i tGW-724i tSH-724 tSH-724i	tDS-734 tDS-734i tGW-734i tSH-734 tSH-734i
System										
CPU	32-bit MCU									
Communication Interface										
Ethernet	10/100 Base-TX, 8-pin RJ-45 x 1, (Auto-negotiating, Auto-MDI/MDIX, LED indicator) PoE (IEEE 802.3af, Class 1)									
COM1	5-wire RS-232		5-wire RS-232	3-wire RS-232	2-wire RS-485 4-wire RS-422	2-wire RS-485	2-wire RS-485	3-wire RS-232 2-wire RS-485 4-wire RS-422	2-wire RS-485	2-wire RS-485
COM2	-		5-wire RS-232	3-wire RS-232	-	2-wire RS-485	2-wire RS-485	-	5-wire RS-232	3-wire RS-232
COM3	-		-	3-wire RS-232	-	-	2-wire RS-485	-	-	3-wire RS-232
Self-Tuner	-				Yes, automatic RS-485 direction control					
Isolation	2500 VDC (for i version)									
ESD Protection	+/-4 kV (for i version)									
COM Port Capability (16C550 or compatible UART)										
Baud Rate	115200 bps Max.									
Data Bit	5, 6, 7, 8									
Parity	None, Odd, Even, Mark, Space									
Stop Bit	1, 2									
Power										
Power Input	IEEE 802.3af, Class 1 for PoE; +12 ~ 48 V _{DC} for DC Jack									
Power Consumption	0.07 A @ 24 V _{DC}									
Mechanical										
Connector	Male DB-9 x 1		10-pin Removable Terminal Block x 1							
Dimensions (W x H x D)	52 mm x 95 mm x 27 mm (tDS/tGW-712: 52 mm x 90 mm x 27 mm) (tDSM-712: 75 mm x 83 mm x 24 mm)									
Installation	DIN-Rail mounting									
Case	Metal for tDSM-712; Plastic for others.									
Environment										
Operating Temperature	-25 °C ~ +75 °C									
Storage Temperature	-30 °C ~ +80 °C									
Humidity	10 ~ 90% RH, non-condensing									

Pin Assignments

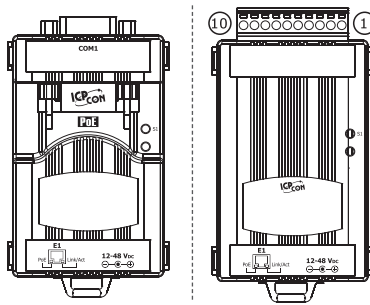

tDS-712(i)/tDSM-712/tGW-712(i)

09	N/A
08	CTS1
07	RTS1
06	N/A
05	GND
04	N/A
03	TxD1
02	RxD1
01	N/A

tDS-722(i)/tGW-722(i)/tSH-722(i)

10	F.G.
09	CTS2
08	RTS2
07	RxD2
06	TxD2
05	GND
04	CTS1
03	RTS1
02	RxD1
01	TxD1

tDS-732(i)/tGW-732(i)/tSH-732(i)

10	F.G.
09	GND
08	RxD3
07	TxD3
06	GND
05	RxD2
04	TxD2
03	GND
02	RxD1
01	TxD1

tDS-735(i)/tGW-735(i)/tSH-735(i)

10	F.G.
09	GND
08	D3-
07	D3+
06	GND
05	D2-
04	D2+
03	GND
02	D1-
01	D1+

tDS-718(i)/tGW-718(i)

10	F.G.
09	N/A
08	GND
07	RxD1
06	TxD1
05	GND
04	RxD1-
03	RxD1+
02	TxD1-/D1-
01	TxD1+/D1+

tDS-715(i)/tGW-715(i)

10	F.G.
09	N/A
08	N/A
07	N/A
06	N/A
05	GND
04	RxD1-
03	RxD1+
02	TxD1-/D1-
01	TxD1+/D1+

tDS-725(i)/tGW-725(i)/tSH-725(i)

10	F.G.
09	N/A
08	N/A
07	N/A
06	GND
05	D2-
04	D2+
03	GND
02	D1-
01	D1+

tDS-724(i)/tGW-724(i)/tSH-724(i)

10	F.G.
09	N/A
08	CTS2
07	RTS2
06	GND
05	RxD2
04	TxD2
03	GND
02	D1-
01	D1+

tDS-734(i)/tGW-734(i)/tSH-734(i)

10	F.G.
09	GND
08	RxD3
07	TxD3
06	GND
05	RxD2
04	TxD2
03	GND
02	D1-
01	D1+

Ordering Information

Non-Isolated	Isolated	Serial Device Server: Includes one CA-002 cable.
tDS-712 CR	tDS-712i CR <i>Available soon</i>	Tiny Device Server with PoE and 1 RS-232 Port (RoHS)
tDS-722 CR	tDS-722i CR <i>Available soon</i>	Tiny Device Server with PoE and 2 RS-232 Ports (RoHS)
tDS-732 CR	tDS-732i CR <i>Available soon</i>	Tiny Device Server with PoE and 3 RS-232 Ports (RoHS)
tDS-715 CR	tDS-715i CR	Tiny Device Server with PoE and 1 RS-422/485 Port (RoHS)
tDS-725 CR	tDS-725i CR <i>Available soon</i>	Tiny Device Server with PoE and 2 RS-485 Ports (RoHS)
tDS-735 CR	tDS-735i CR <i>Available soon</i>	Tiny Device Server with PoE and 3 RS-485 Ports (RoHS)
tDS-718 CR	tDS-718i CR <i>Available soon</i>	Tiny Device Server with PoE and 1 RS-232/422/485 Port (RoHS)
tDS-724 CR	tDS-724i CR <i>Available soon</i>	Tiny Device Server with PoE, 1 RS-485 and 1 RS-232 Ports (RoHS)
tDS-734 CR	tDS-734i CR <i>Available soon</i>	Tiny Device Server with PoE, 1 RS-485 and 2 RS-232 Ports (RoHS)
tDSM-712 CR <i>NEW</i>	-	TTiny Device Server with PoE and 1 RS-232 Port (Metal case, RoHS)
Non-Isolated	Isolated	Modbus/TCP to RTU/ASCII Gateway: Includes one CA-002 cable.
tGW-712 CR	tGW-712i CR <i>Available soon</i>	Tiny Modbus/TCP to RTU/ASCII Gateway with PoE and 1 RS-232 Port (RoHS)
tGW-722 CR	tGW-722i CR <i>Available soon</i>	Tiny Modbus/TCP to RTU/ASCII Gateway with PoE and 2 RS-232 Ports (RoHS)
tGW-732 CR	tGW-732i CR <i>Available soon</i>	Tiny Modbus/TCP to RTU/ASCII Gateway with PoE and 3 RS-232 Ports (RoHS)
tGW-715 CR	tGW-715i CR	Tiny Modbus/TCP to RTU/ASCII Gateway with PoE and 1 RS-422/485 (RoHS)
tGW-725 CR	tGW-725i CR <i>Available soon</i>	Tiny Modbus/TCP to RTU/ASCII Gateway with PoE and 2 RS-485 Ports (RoHS)
tGW-735 CR	tGW-735i CR <i>Available soon</i>	Tiny Modbus/TCP to RTU/ASCII Gateway with PoE and 3 RS-485 Ports (RoHS)
tGW-718 CR	tGW-718i CR <i>Available soon</i>	Tiny Modbus/TCP to RTU/ASCII Gateway with PoE and 1 RS-232/422/485 Port (RoHS)
tGW-724 CR	tGW-724i CR <i>Available soon</i>	Tiny Modbus/TCP to RTU/ASCII Gateway with PoE, 1 RS-485 and 1 RS-232 Ports (RoHS)
tGW-734 CR	tGW-734i CR <i>Available soon</i>	Tiny Modbus/TCP to RTU/ASCII Gateway with PoE, 1 RS-485 and 2 RS-232 Ports (RoHS)
Non-Isolated	Isolated	Serial Port Sharer: Includes one CA-002 cable.
tSH-722 CR	tSH-722i CR <i>Available soon</i>	Tiny Serial Port Sharer with PoE and 2 RS-232 Ports (RoHS)
tSH-732 CR	tSH-732i CR <i>Available soon</i>	Tiny Serial Port Sharer with PoE and 3 RS-232 Ports (RoHS)
tSH-725 CR	tSH-725i CR <i>Available soon</i>	Tiny Serial Port Sharer with PoE and 2 RS-485 Ports (RoHS)
tSH-735 CR	tSH-735i CR <i>Available soon</i>	Tiny Serial Port Sharer with PoE and 3 RS-485 Ports (RoHS)
tSH-724 CR	tSH-724i CR <i>Available soon</i>	Tiny Serial Port Sharer with PoE, 1 RS-485 and 1 RS-232 Ports (RoHS)
tSH-734 CR	tSH-734i CR <i>Available soon</i>	Tiny Serial Port Sharer with PoE, 1 RS-485 and 2 RS-232 Ports (RoHS)

3

7

Serial Device Server

Accessories

CA-002

DC connector to 2-wire power cable, 0.3 M



CA-0915

Male DB-9 to Female DB-9 Cable, 1.5 m



CA-0910F

Female DB-9 to Female DB-9 Cable, 1.0 m



CA-0910N

DB-9 Female-Female 3-wire Null Modem Cable, 1M



CA-PC09F

DB-9 Female Connector with Plastic Cover



FRA05-S12-SU CR

12V/0.58A (max.) Power Supply (RoHS, for tDS/tGW-700)



DIN-KA52F CR

24V/1.04A, 25 W Power Supply with DIN-Rail Mounting (RoHS, for NS-205 and NS-205PSE-24V)



DIN-KA52F-48 CR

48V/0.52A, 25 W Power Supply with DIN-Rail Mounting (RoHS, for NS-205PSE)



NS-205PSE CR

Unmanaged Ethernet Switch with 4 PoE Ports and 1 RJ-45 Uplink (RoHS)



NS-205PSE-24V CR

Unmanaged 5-port 10/100 Mbps PoE (PSE) Ethernet Switch; 24 Vdc Input (RoHS)

