



TPD-703

TPD-703-64

Features

- Excellent C/P ratio (cost/performance)
- High-resolution color touch screen
- PoE (Power over Ethernet)
- RTC (Real Time Clock)
- Free HMIWorks development tool
- Supports C programming language and Ladder Designer
- Supports the custom communication protocol (C language)
- Modbus TCP/RTU protocol



Introduction

TPD 7 inch series is a series of tiny touch HMI and designed for building and home automation. TPD 7 inch series is equipped with high resolution TFT color touch screen and fits in with regular electrical wall-mount outlet. Besides, it is seamlessly integrated with rich I/O modules and presents beautiful, flexible and user-defined picture frame. In short, it is the best choice to upgrade the mechanical switch to intelligent control pads.

For PLC users, HMIWorks provides Ladder Designer, and for IT users, C language environment is provided. Especially, it only takes no more than 30 minutes to learn how to create an application program of TPD-series devices when using Ladder Designer.

Specifications

Models	TPD-703	TPD-703-64
CPU Module		
CPU	32-bit RISC CPU	
Memory Expansion	16 MB SDRAM/16 MB Flash	64 MB SDRAM/64 MB Flash
Real Time Clock (RTC)	Yes	
Buzzer	Yes	
Rotary Switch (0 ~ 9)	Yes	
Communication Interface		
Serial Port	COM1	RS-485 (including Self-Tuner) ; Non-isolation
	COM2	RS-232 (3-pin) ; Non-isolation
Ethernet	RJ-45 x 1, 10/100 Base-TX	
MMI (Main Machine Interface)		
LCD	7" TFT (Resolution 800 x 480 , 65535 colors), defective pixels <= 3	
Backlight Life	20,000 hours	
Brightness	250 cd/m2	400 cd/m2
Touch Panel	4-wire, analog resistive; Light Transmission: 80%	
Reset Button	Yes	
Electrical		
Powered from Terminal Block	+12 ~ 48 VDC	
Powered from PoE	IEEE 802.3af, Class1 (48 V)	
Power Consumption	3.6W	
Mechanical		
Dimensions (W x L x H)	217 mm x 153 mm x 33 mm	
Installation	Wall Mount	
Ingress Protection	Front Panel: IP40	
Environmental		
Operating Temperature	-10 ~ +60°C	
Storage Temperature	-20 ~ +70°C	
Ambient Relative Humidity	10 ~ 90% RH, non-condensing	

Appearance

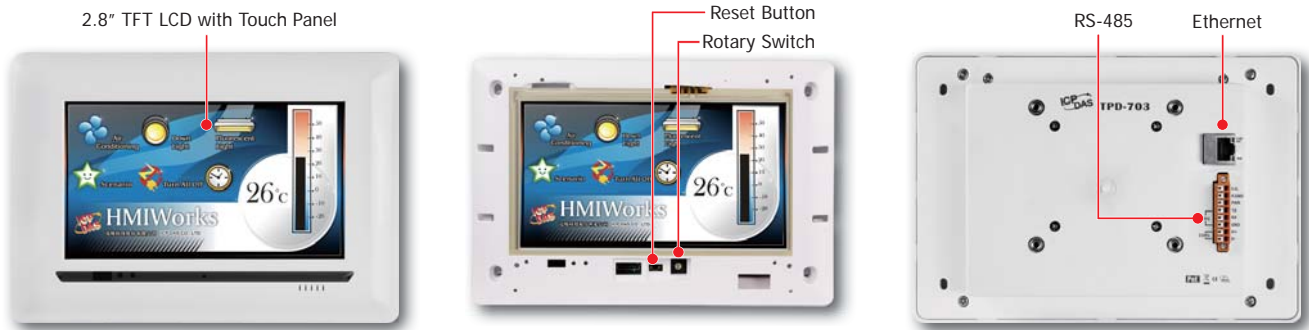

Dimensions (Units: mm)

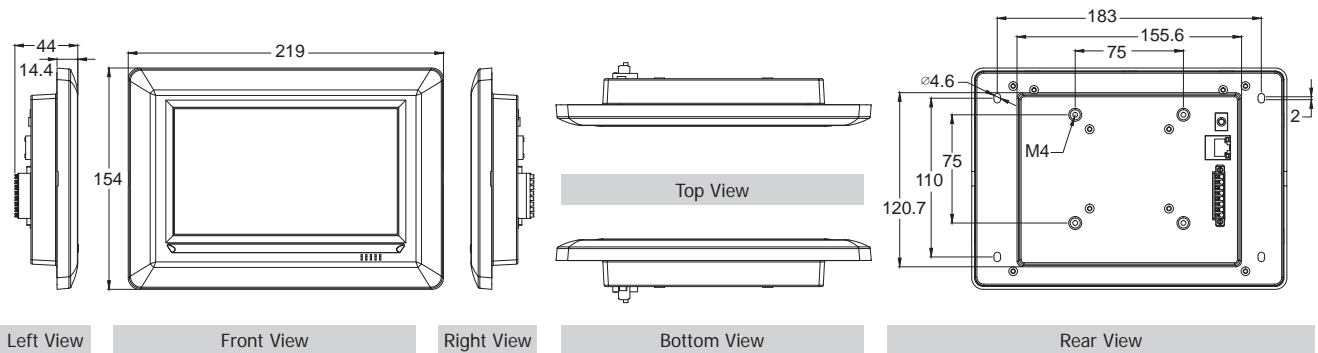

Pin Assignments

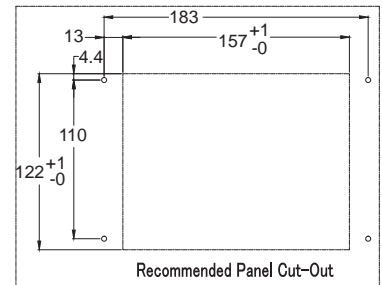
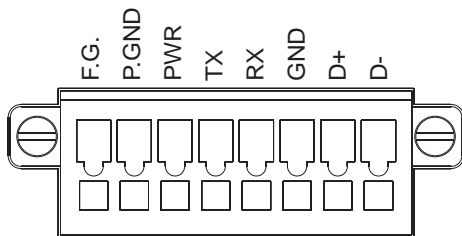



Wall Mounting

Ordering Information

TPD-703 CR	7" Touch HMI device with RS-232 (3-pin, Non-isolation), RS-485 (including Self-Tuner, Non-isolation), RTC, Ethernet, PoE (RoHS)
TPD-703-64 CR	7" Touch HMI device with RS-232 (3-pin, Non-isolation), RS-485 (including Self-Tuner, Non-isolation), RTC, Ethernet, PoE (RoHS)

Accessories

	1C016	2.4 mm Screw driver
	NS-208PSE CR	Unmanaged Industrial PoE (Power over Ethernet) Ethernet Switch (RoHS)
	MDR-60-24 CR	24 Vdc/2.5 A, 60 W Power Supply with DIN-Rail Mounting (RoHS)