



PM-3112/PM-3114

2/4 Loops single-phase Smart Power Meter

Features

- True RMS Power Measurements
- Energy Analysis for 1P2W, 1P4W
- Current Measurements Up to 200 A with Different CT Ratio
- Voltage Measurements Up to 300 V
- Clip-on CT for Easy Installation
- W Accuracy Better than 0.5% (PF=1)
- Supports RS-485, Ethernet or CANopen Interface
- Supports Modbus RTU, Modbus TCP or CANopen Protocol
- Supports 2 Power Relay Output (Form A)
- IEC 61010-1and EN 61010-1



Introduction

ICP DAS brings the most powerful, cost-effective, advanced Smart Power Meters PM-3000 series that gives you access to real-time electric usage for single-phase power measurement. With its high accuracy ($< 0.5\%$, PF=1), the PM-3000 series can be applied to both low voltage primary side and/or medium/high voltage secondary side and enables the users to obtain reliable and accurate energy consumption readings from the monitored equipments in real time under operation. These compact size and cost-effective power meters are equipped with revolutionary wired clip-on CT (various types, support input current up to 200 A). It operates over a wide input voltages range 10 ~ 300 VAC which allows worldwide compatibility. And with 2 channels relay outputs, it can be linked with sirens or lightings for alarm messages. It also supports Modbus RTU, Modbus TCP or CANopen protocols for easy integration.

Specifications

Models	PM-3112	PM-3114	PM-3112-MTCP	PM-3114-MTCP	PM-3112-CPS	PM-3114-CPS
AC Power Measurement						
Wiring	1P2W-2CT	1P4W-4CT	1P2W-2CT	1P4W-4CT	1P2W-2CT	1P4W-4CT
Input Voltage	10 ~ 300 V					
Input Current	CTØ10 mm (60 A); CTØ16 mm (100 A); CTØ24 mm (200 A)					
Input Frequency	50/60 Hz					
W Accuracy	Better than 0.5% (PF=1)					
Starting Current	$>0.03A$ (60A), $>0.05A$ (100A), $>0.09A$ (200A)					
Power Parameter Measurement	True RMS voltage (Vrms), True RMS current (Irms), Active Power (kW), Active Energy (kWh), Apparent Power (kVA), Apparent Energy (kVAh), Reactive Power (kVAR), Reactive Energy (kVARh), Power Factor (PF), Frequency					
Data Update Rate	1 Second					
Communication						
RS-485	Protocol	Modbus-RTU	-	-	-	-
	Baud rate	9600,19200 (default), 38400, 115200; DIP Switch Selectable	-	-	-	-
	Data format	N,8,1	-	-	-	-
	Isolation	2500 Vdc	-	-	-	-
Ethernet	Protocol	-	Modbus TCP	-	-	-
CANopen	Protocol	-	-	-	CANopen	
	Baud rate	-	-	-	125 k (default), 250 k, 500 k, 1 M; DIP Switch Selectable	
Alarm Output						
Power Relay	Form A (Normal Open) x 2; Relay Contact Voltage Range: 5 A @ 250 VAC (47 ~ 63Hz), 5 A @ 30 VDC					
Power						
Input Range	+12 ~ 48 VDC		+12 ~ 48 VDC		+12 ~ 48 VDC	
Power Consumption	2 W					
Mechanical						
Casing	Plastic					
Dimensions (W x L x H)	127 mm x 105 mm x 33 mm					
Module Installation	DIN-Rail Mounting					
CT Installation	Clip-On					
Environment						
Operating Temperature	-10 ~ +70 °C					
Storage Temperature	-25 ~ +80 °C					
Ambient Relative Humidity	10% ~ 90% RH, Non-condensing					

Appearance

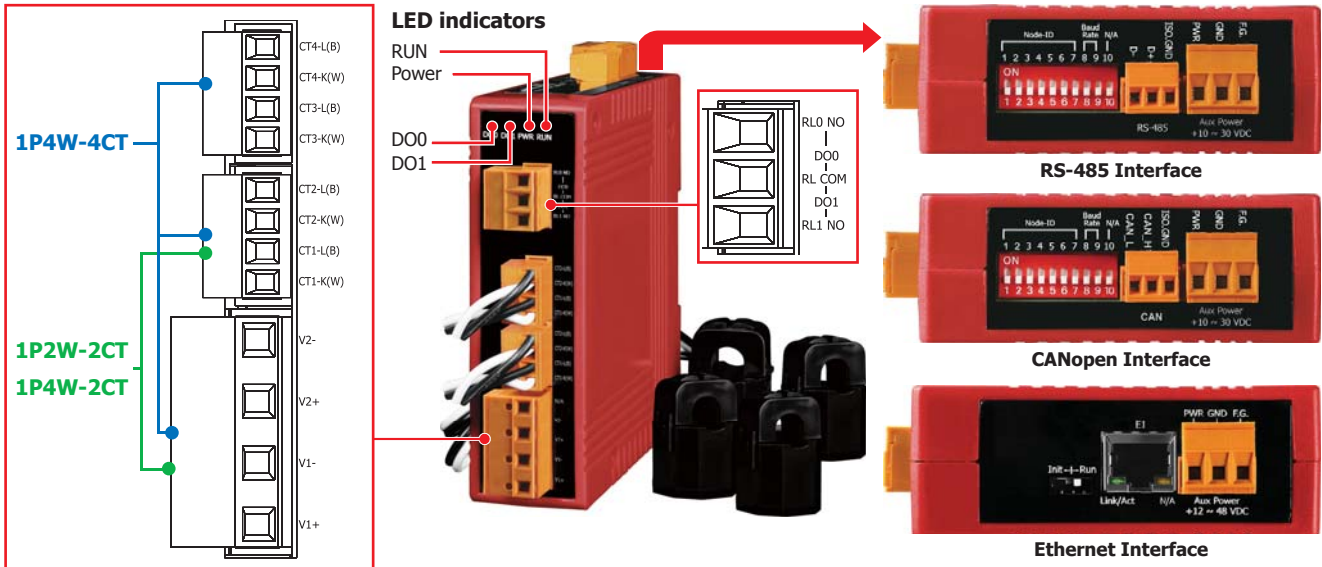

Dimensions (Units: mm)

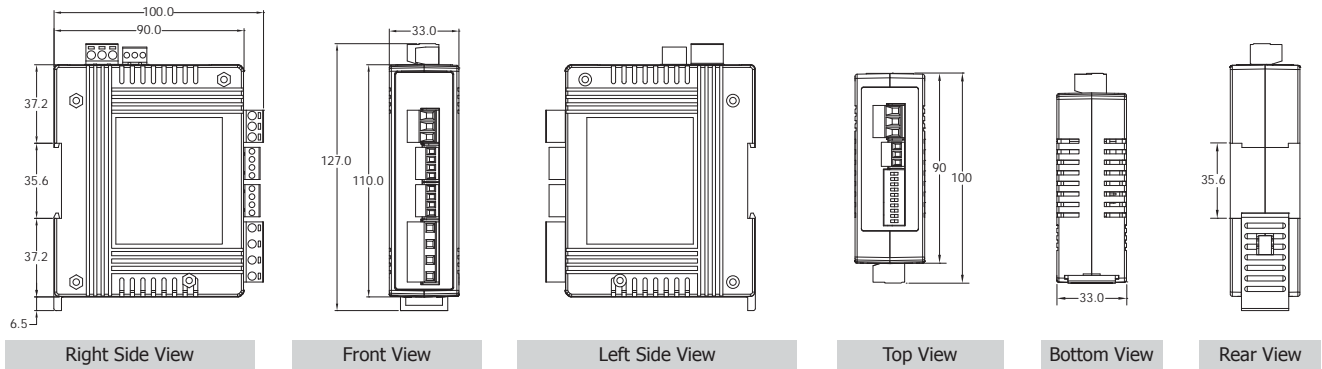

Selection Guide

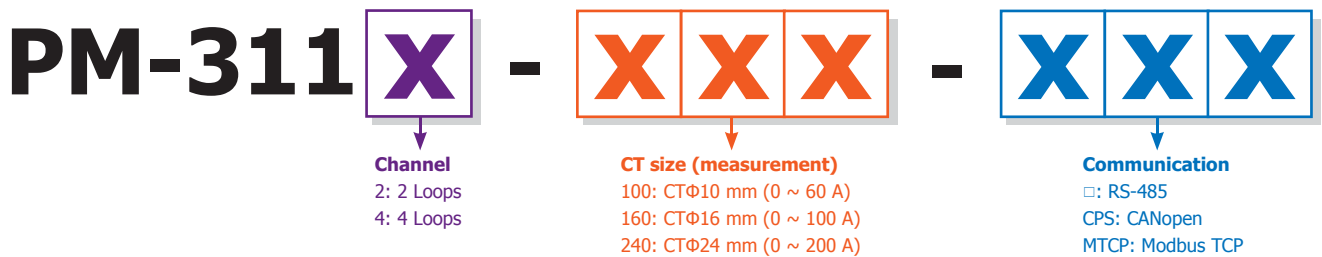

Ordering Information

RS-485 Interface	
PM-3112-100	Modbus RTU; 2 loops single-phase Power Meter with 2 CTs (60 A)
PM-3112-160	Modbus RTU; 2 loops single-phase Power Meter with 2 CTs (100 A)
PM-3112-240	Modbus RTU; 2 loops single-phase Power Meter with 2 CTs (200 A)
Ethernet Interface (New)	
PM-3112-100-MTCP	Modbus TCP; 2 loops single-phase Power Meter with 2 CTs (60 A)
PM-3112-160-MTCP	Modbus TCP; 2 loops single-phase Power Meter with 2 CTs (100 A)
PM-3112-240-MTCP	Modbus TCP; 2 loops single-phase Power Meter with 2 CTs (200 A)
CANopen Interface (New)	
PM-3112-100-CPS	CANopen; 2 loops single-phase Power Meter with 2 CTs (60 A)
PM-3112-160-CPS	CANopen; 2 loops single-phase Power Meter with 2 CTs (100 A)
PM-3112-240-CPS	CANopen; 2 loops single-phase Power Meter with 2 CTs (200 A)

RS-485 Interface	
PM-3114-100	Modbus RTU, 4 loops single-phase power meter (60 A)
PM-3114-160	Modbus RTU, 4 loops single-phase power meter (100 A)
PM-3114-240	Modbus RTU, 4 loops single-phase power meter (200 A)
Ethernet Interface (New)	
PM-3114-100-MTCP	Modbus TCP, 4 loops single-phase power meter (60 A)
PM-3114-160-MTCP	Modbus TCP, 4 loops single-phase power meter (100 A)
PM-3114-240-MTCP	Modbus TCP, 4 loops single-phase power meter (200 A)
CANopen Interface (New)	
PM-3114-100-CPS	CANOpen, 4 loops single-phase power meter (60 A)
PM-3114-160-CPS	CANOpen, 4 loops single-phase power meter (100 A)
PM-3114-240-CPS	CANOpen, 4 loops single-phase power meter (200 A)

• CT for Smart Power Meter

■ Dimensions (Units: mm)

100: CTΦ10mm (60 A Max.)

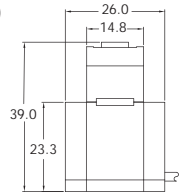

Left View

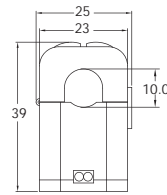

Front View

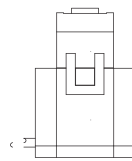

Right View

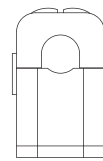

Rear View

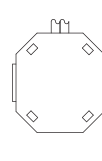

Bottom View

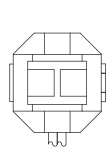

Top View

160: CTΦ16mm (100 A Max.)

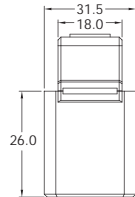

Left View

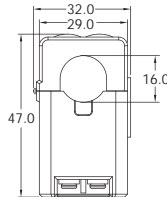

Front View

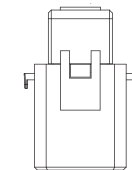

Right View

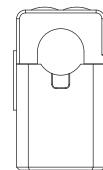

Rear View

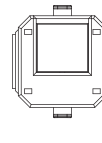

Bottom View

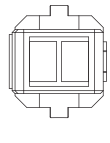

Top View

240: CTΦ24mm (200 A Max.)

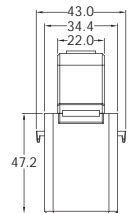

Left View

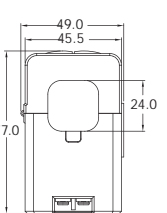

Front View

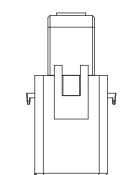

Right View

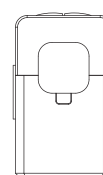

Rear View

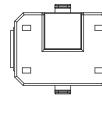

Bottom View

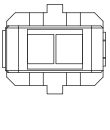

Top View

■ Wiring for 220V with no neutral

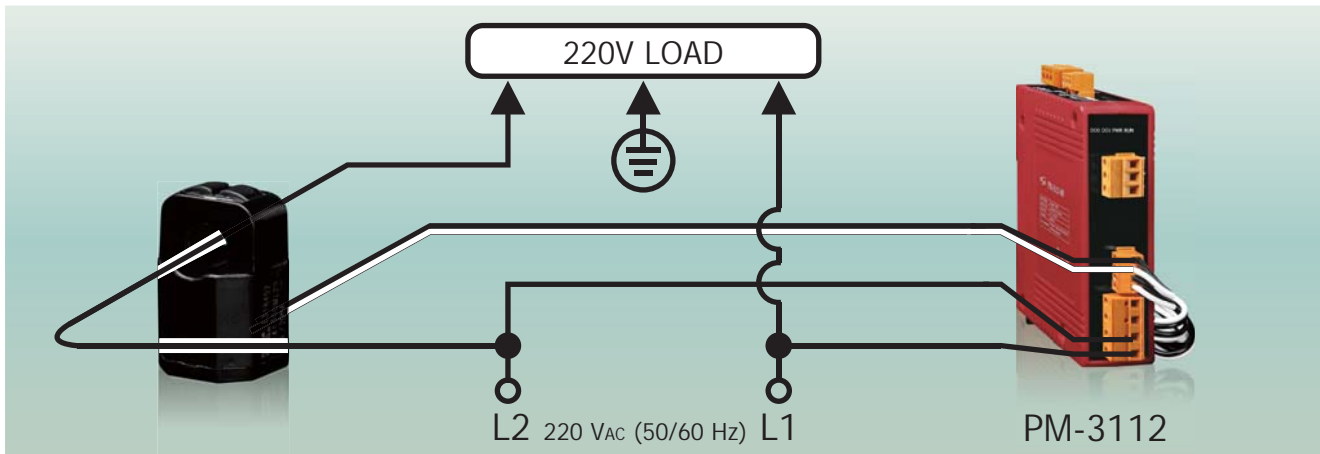

■ Installation



DIN-Rail Mounting

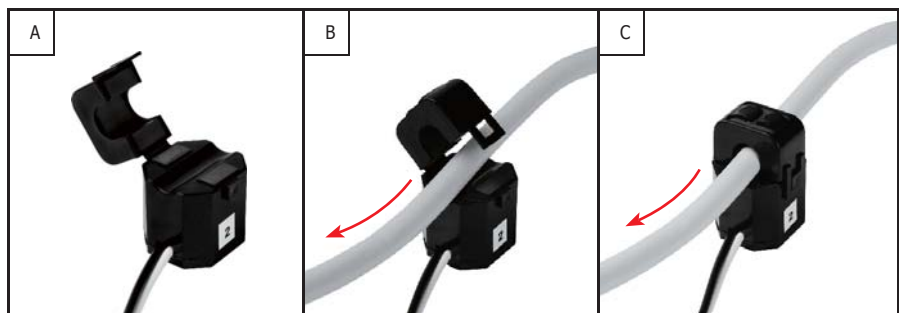

Clip-on CT Installation