

# **ET-M8194H**

# **Motion Control Module**

# **User Manual**

(Version 3.1)

**API Library**



**ICP DAS CO., LTD.**

---

## **Warranty**

All products manufactured by ICPDAS Inc. are warranted against defective materials for a period of one year from the date of delivery to the original purchaser.

## **Warning**

ICPDAS Inc. assumes no liability for damages consequent to the use of this product. ICPDAS Inc. reserves the right to change this manual at any time without notice. The information furnished by ICPDAS Inc. is believed to be accurate and reliable. However, no responsibility is assumed by ICPDAS Inc. for its use, or for any infringements of patents or other rights of third parties resulting from its use.

## **Copyright**

Copyright 2007-2012 by ICPDAS Inc., LTD. All rights reserved worldwide.

## **Trademark**

The names used for identification only maybe registered trademarks of their respective companies.

## **License**

The user can use, modify and backup this software on a single machine. The user may not reproduce, transfer or distribute this software, or any copy, in whole or in part.

<b>1</b>	<b>PREFACE.....</b>	<b>9</b>
1.1	Introduction.....	9
1.2	Function Categories.....	10
1.3	API Command Modbus Setup.....	19
<b>2</b>	<b>COMMUNICATION FUNCTIONS.....</b>	<b>20</b>
2.1	TCP/IP Communication Functions.....	20
2.1.1	Create TCP/IP Connection.....	20
2.1.2	Close TCP/IP Connection.....	21
2.1.3	Get TCP/IP Connection State.....	22
2.1.4	Modbus TCP Data.....	23
2.1.5	Set Modbus TCP Register Order.....	24
2.1.6	Get Modbus TCP Register Order.....	25
2.2	Communication Return Code.....	26
<b>3</b>	<b>BASIC SETTINGS.....</b>	<b>28</b>
3.1	Axes Code Definition.....	28
3.2	Motion Module Reset.....	29
3.2.1	Restore the Default Settings.....	29
3.2.2	Clear Command Buffer.....	30
3.3	Pules Output Mode Setting.....	31
3.4	Maximum Speed Setting.....	33
3.5	Trigger Level Setting of Hardware Limit Switch.....	35
3.6	Motion Stop Mode Setting of Limit Switch.....	37
3.7	Trigger Level Setting of Near Home Sensor.....	39
3.8	Trigger Level Setting of Home Sensor.....	41
3.9	Software Limit Setting.....	43
3.9.1	Set the Software Limit Value.....	43
3.9.2	Clear the Software Limit Value.....	45
3.10	Encoder Related Parameter Settings.....	47
3.11	Servo Driver (ON/OFF) Setting.....	50
3.11.1	Servo On.....	50
3.11.2	Servo Off.....	52
3.12	Servo Alarm Setting.....	53
3.13	Active Level Setting of In-Position Signals.....	55
3.14	Digital Filter Setting.....	57
3.15	Position Counter Variable Ring Setting.....	59
3.15.1	Enable the Ring Counter Function.....	59
3.15.2	Disable the Ring Counter Function.....	61
3.16	Triangle Velocity Profile Prevention Setting.....	63
3.16.1	Enable the Triangle Prevention Function.....	63

3.16.2	Disable the Triangle Prevention Function .....	65
<b>3.17</b>	<b>External Pulse Input .....</b>	<b>67</b>
3.17.1	Handwheel (Manual Pulse Generator) Driving .....	67
3.17.2	Fixed Pulse Driving Mode.....	69
3.17.3	Continuous Pulse Driving Mode .....	71
3.17.4	External Signal Input Setting.....	73
<b>3.18</b>	<b>Read/Write User-Defined Variables (VAR and bVAR) .....</b>	<b>74</b>
3.18.1	Read Byte Variable.....	74
3.18.2	Write Byte Variable.....	76
3.18.3	Read Long Variable.....	78
3.18.4	Write Long Variable.....	80
<b>3.19</b>	<b>Read/Write Data for Power Outage Carry-Over (MD) .....</b>	<b>82</b>
3.19.1	Read the Machine Data .....	82
3.19.2	Write the Machine Data .....	84
<b>4</b>	<b>MOTION CONTROLLER STATUS .....</b>	<b>87</b>
<b>4.1</b>	<b>Set and Read Commanded Position .....</b>	<b>87</b>
4.1.1	Set the Logical Position Counter .....	87
4.1.2	Read the Logical Position Counter .....	89
<b>4.2</b>	<b>Set and Read the Encoder Counter .....</b>	<b>92</b>
4.2.1	Set the Encoder Position Counter .....	92
4.2.2	Read the Encoder Position Counter .....	94
<b>4.3</b>	<b>Set and Read Absolute Position .....</b>	<b>97</b>
4.3.1	Set the Absolute Position Counter.....	97
4.3.2	Read the Absolute Position Counter .....	99
<b>4.4</b>	<b>Get Current Velocity .....</b>	<b>102</b>
<b>4.5</b>	<b>Get Current Acceleration .....</b>	<b>104</b>
<b>4.6</b>	<b>Get DI Triggered Motion Status .....</b>	<b>106</b>
4.6.1	Get Single DI Triggered Motion Status .....	106
4.6.2	Get All DI Triggered Motion Status.....	108
<b>4.7</b>	<b>Get DI Signal .....</b>	<b>110</b>
4.7.1	Get Single DI Signal Status.....	110
4.7.2	Get All DI Signal Status.....	112
<b>4.8</b>	<b>Get Home Status.....</b>	<b>114</b>
<b>4.9</b>	<b>Get and Clear Error Status .....</b>	<b>117</b>
4.9.1	Check Error Status.....	117
4.9.2	Get Error Code .....	119
<b>4.10</b>	<b>Get Buffer Status .....</b>	<b>122</b>
<b>4.11</b>	<b>Get Stop Status .....</b>	<b>123</b>
<b>4.12</b>	<b>Get Software Emergency Status .....</b>	<b>125</b>
<b>4.13</b>	<b>Get Driving Axis .....</b>	<b>126</b>
<b>4.14</b>	<b>Get Interpolation Ready Flag .....</b>	<b>127</b>
<b>4.15</b>	<b>Get Triggered Interrupt Factors.....</b>	<b>128</b>
<b>4.16</b>	<b>Get ET-M8194H State.....</b>	<b>130</b>
4.16.1	Command Download and Execution Procedure .....	130

4.16.2	Get ET-M8194H Status .....	132
<b>5</b>	<b>FRNET FUNCTIONS .....</b>	<b>136</b>
<b>5.1</b>	<b>Get FRnet DIO Signals .....</b>	<b>136</b>
5.1.1	Read FRnet Group Data (MP) .....	136
5.1.2	Read FRnet Channel Data (MP) .....	138
5.1.3	Read FRnet Channel Data (RTC) .....	139
5.1.4	Read FRnet Group Data (RTC) .....	140
5.1.5	Read FRnet Multi-group Data (RTC) .....	141
<b>5.2</b>	<b>Set FRnet DO .....</b>	<b>142</b>
5.2.1	Set FRnet DO Group Data (MP) .....	142
5.2.2	Set FRnet DO Channel Data (MP) .....	145
5.2.3	Set FRnet DO Channel Data (RTC) .....	146
5.2.4	Set FRnet DO Group Data (RTC) .....	147
5.2.5	Set FRnet Multi-group DO Data (RTC) .....	148
<b>5.3</b>	<b>FRnet Wait .....</b>	<b>150</b>
<b>5.4</b>	<b>FRnet DI Trigger Event Setting .....</b>	<b>151</b>
<b>5.5</b>	<b>Get FRnet DI Trigger Event Setting .....</b>	<b>152</b>
<b>6</b>	<b>AUTO HOMING SEARCH .....</b>	<b>153</b>
<b>6.1</b>	<b>Set Home Search Speed .....</b>	<b>154</b>
<b>6.2</b>	<b>Limit Switch as the Home Sensor Setting .....</b>	<b>155</b>
<b>6.3</b>	<b>Home Search Mode Setting .....</b>	<b>156</b>
<b>6.4</b>	<b>Start Automatic Home Search Execution .....</b>	<b>158</b>
<b>7</b>	<b>MOTION CONTROL COMMANDS .....</b>	<b>159</b>
<b>7.1</b>	<b>Single Axis Motion Control .....</b>	<b>159</b>
7.1.1	Acceleration/Deceleration Mode Setting .....	160
7.1.2	Initial Speed Setting .....	163
7.1.3	Drive Speed Setting .....	165
7.1.4	Acceleration Setting .....	166
7.1.5	Deceleration Setting .....	168
7.1.6	Acceleration Rate Setting .....	170
7.1.7	Deceleration Rate Setting .....	172
7.1.8	Offset Setting .....	174
7.1.9	Relative Distance Motion .....	176
7.1.10	Change Target Position on the Fly .....	178
7.1.11	Move to Absolute Position .....	180
7.1.12	Continue Pulse Driving Output .....	182
<b>7.2</b>	<b>Interpolation Commands .....</b>	<b>184</b>
7.2.1	Interpolation Axes Assignment .....	184
7.2.2	Speed and Acc/Dec Mode Setting .....	186
7.2.3	Vector Initial Speed Setting .....	192
7.2.4	Vector Speed Setting .....	193
7.2.5	Vector Acceleration Setting .....	194
7.2.6	Vector Deceleration Setting .....	196

7.2.7	Vector Acceleration Rate Setting .....	198
7.2.8	Vector Deceleration Rate Setting .....	200
7.2.9	Vector Offset Pulses Setting .....	202
7.2.10	2-Axis Interpolation Relative Distance Motion .....	204
7.2.11	2-Axis Interpolation Absoul Position Motion .....	206
7.2.12	3-Axis Interpolation Relative Distance Motion .....	208
7.2.13	3-Axis Interpolation Absolute Position Motion .....	210
7.2.14	2-Axis Circular Interpolation Relative Distance Motion (an CW Arc).....	212
7.2.15	2-Axis Circular Interpolation Relative Distance Motion (an CCW Arc) ..	214
7.2.16	2-Axis Circular Interpolation Absoul Position Motion (an CW Arc).....	216
7.2.17	2-Axis Circular Interpolation Absoul Position Motion (an CCW Arc) ...	218
7.2.18	2-Axis Circular Interpolation Motion (Complete CW Circle).....	220
7.2.19	2-Axis Circular Interpolation Motion (Complete CCW Circle) .....	222
<b>7.3</b>	<b>Synchronous Actions.....</b>	<b>224</b>
7.3.1	Setting the Activation Factors.....	224
7.3.2	Clear Synchronization Condition.....	233
7.3.3	Set the Synchronization Condition .....	234
7.3.4	Set the Synchronization Axis .....	236
7.3.5	Set the Synchronization Action.....	237
7.3.6	COMPARE Value Setting.....	242
7.3.7	Get LATCH Value.....	244
7.3.8	PRESET Data for Synchronous Action Setting .....	247
7.3.9	OUT Data Setting.....	249
7.3.10	Enable Interrupt Functions of i-8094H .....	251
7.3.11	Disable Interrupt Functions of i-8094H .....	252
7.3.12	Set Interrupt Factor of i-8094H .....	253
7.3.13	Clear Interrupt Factor of i-8094H.....	257
<b>7.4</b>	<b>Continuous Interpolation .....</b>	<b>259</b>
7.4.1	2-Axis Rectangular Motion .....	259
7.4.2	Set the Speed of 2-Axis Continuous Linear Interpolation .....	262
7.4.3	Execute a 2-Axis Continuous Linear Interpolation (Relative Distance)..	264
7.4.4	Execute a 2-Axis Continuous Linear Interpolation (Absoul Position)..	266
7.4.5	Set the Speed of 3-Axis Continuous Linear Interpolation .....	268
7.4.6	Execute a 3-Axis Continuous Linear Interpolation (Relative Distance)..	270
7.4.7	Execute a 3-Axis Continuous Linear Interpolation (Absoul Position)..	272
7.4.8	Set the Speed of Mixed 2-axis motions in Continuous Interpolation ....	274
7.4.9	Execute a Mixed 2-axis motions in Continuous Interpolation (Relative Distance) .....	276
7.4.10	Execute a Mixed 2-axis motions in Continuous Interpolation (Absoul Position).....	278
7.4.11	3-Axis Helical Motion .....	280
7.4.12	Set Synchronous Line Scan Motion .....	282
7.4.13	Start Synchronous Line Scan Motion .....	284
7.4.14	Get Synchronous Line Scan Motion Status .....	286
<b>7.5</b>	<b>Stop and Hold Functions .....</b>	<b>287</b>
7.5.1	Driving Command Hold .....	287
7.5.2	Release Holding Status and Start Driving .....	289
7.5.3	Decelerate and Finally Stop Axes .....	291
7.5.4	Immediately Stop Axes .....	292
7.5.5	Decelerate and Finally Stop Interpolation Motion.....	293

7.5.6	Immediately Stop Interpolation Motion.....	294
7.5.7	Clear Axes Stop Status .....	295
7.5.8	Clear Interpolation Motion Stop Status.....	296
7.5.9	End of Interpolation .....	297
7.5.10	Emergency Stop.....	298
7.5.11	Clear Emergency Stop .....	299
<b>8</b>	<b>INITIAL PARAMETER TABLE .....</b>	<b>300</b>
8.1	Calling the Initial Table.....	302
<b>9</b>	<b>MACRO PROGRAMMING.....</b>	<b>304</b>
	Introduction .....	304
9.1	Create MP Macro Program Codes .....	305
9.1.1	Start a MP Macro Program Codes Programming.....	305
9.1.2	End a MP Macro Program Codes Programming .....	307
9.1.3	MP Macro Program Execution.....	308
9.2	Create ISR Macro Program Codes .....	311
9.2.1	Start a ISR Macro Program Codes Programming .....	311
9.2.2	End a ISR Macro Program Codes Programming.....	312
9.2.3	ISR Macro Program (ISR) Execution.....	313
9.3	User Defined Variables .....	314
9.3.1	Assign Macro variable a value .....	314
9.3.2	Get Command Return Value .....	316
9.4	Simple Calculations.....	318
9.5	Command Loop (FOR~NEXT) .....	321
9.5.1	Start of FOR Loop Block.....	321
9.5.2	End of FOR Loop Block.....	324
9.5.3	FOR Loop Block Exit.....	325
9.6	Conditional Command (IF~ELSE) .....	326
9.6.1	IF Condition .....	326
9.6.2	ELSE Statement.....	330
9.6.3	End of IF Statement.....	331
9.7	Jump Commands (GOTO-LABEL).....	332
9.7.1	GOTO Statement .....	332
9.7.2	LABEL Statement .....	334
9.8	Timer .....	335
9.9	Wait Until Motion Command has been Executed .....	336
9.10	Exit Macro Program.....	337
9.11	Terminate all Macro Executions.....	339
9.12	Get Macro Download Status .....	341
9.13	Change Velocity on the Fly .....	344
<b>10</b>	<b>STAND ALONE CONTROLLER.....</b>	<b>345</b>
<b>11</b>	<b>LIBRARY VERSION .....</b>	<b>348</b>

11.1	Modbus P824 Library.....	348
11.2	i-8094H Library Version.....	349
11.3	ET-M8194H DLL Version.....	350
<b>12</b>	<b>APPENDIX.....</b>	<b>351</b>
12.1	MODBUS Input Registers.....	351
12.1.1	Read FRnet DI/O.....	352
12.1.2	Read Motion Chip DI Status of Daughterboard.....	353
12.1.3	Read Error Code.....	354
12.1.4	Read Logic and Encoder Position, Acceleration, Velocity.....	355
12.1.5	Read Stop Status.....	356
12.1.6	Read Latch.....	357
12.1.7	Read Error State and Free Buffer Size.....	358
12.1.8	Read i-8094H Interrupt.....	359
12.1.9	Read Firmware Version.....	360
12.1.10	Read DI Signal of Daughterboard.....	361
12.1.11	Read Absolute Logic Position.....	362
12.1.12	Read ET-M8194H and i-8094H State.....	363
12.1.13	Macro Program Download Error Messages.....	365
12.1.14	Macro Program Execution Error Messages.....	366
12.1.15	Motion Chip Triggered Interrupt.....	367
12.2	Holding Registers.....	368
12.2.1	FRnet DO.....	369
12.2.2	Macro Call, FRnet Event and WORD Order Setting.....	370
12.2.3	IP Address Setting.....	371
12.2.4	Read/ Write Logic and Encoder Position, Acceleration, Velocity.....	372
12.2.5	Read/ Write VAR Variables.....	373
12.2.6	Sub Function Code Definition.....	374
12.3	Sub-Function Code Mapping Table.....	375
12.4	MODBUS Coil Table.....	384
12.4.1	FRnet Digital Output.....	385
12.4.2	Servo On/Off.....	389
12.5	MODBUS Discrete Input Table.....	390
12.5.1	FRnet Digital Input.....	391
12.5.2	DI or Status of Control Board.....	395
12.5.3	Error Stop States.....	398
12.5.4	DI Signal of Control Board.....	401
<b>13</b>	<b>ET-M8194H LED DESCRIPTION.....</b>	<b>403</b>
<b>14</b>	<b>EZMOVE UTILITY.....</b>	<b>405</b>
14.1	IP Configuration.....	405
14.2	Firmware Update Procedure.....	408



<b>Version</b>	<b>Author</b>	<b>Date</b>	<b>Description of changes</b>
v1.0	Edward	13-JAN-2008	▪ The first version.
v2.0	Allen	13-NOV-2012	▪ The second version.
V3.0	Martin	11-MAR-2015	▪ Added absolute position motion commands description. These commands are supported by <ul style="list-style-type: none"> <li>○ ET-M8194H firmware version 3.0</li> <li>○ DLL version 2.0.8</li> </ul>
V3.1	Kevin	8-APR-2015	▪ Fix some typo.

---

# 1 Preface

---

## 1.1 Introduction

ET-M8194H is an Ethernet based 4-axis stepping/pulse-type motion controller and uses Modbus TCP/IP as a communication protocol between client and server. This intelligent motion controller also has a variety of built in motion control functions, such as 2/3- axis linear interpolation, 2-axis circular interpolation, T/S-curve acceleration/deceleration, various synchronous actions and automatic homing.

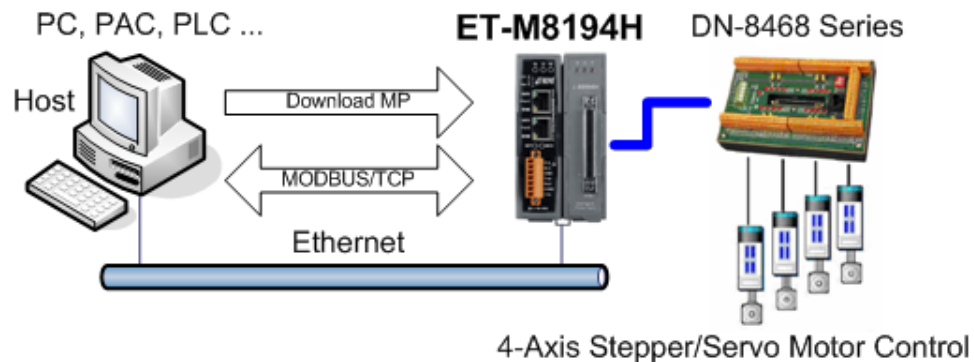

The ET-M8194H provides a non-volatile memory for downloading small MACRO programs. A MACRO program basically consists of a sequence of motion instructions. In addition arithmetic operation, conditional (if...else) execution, looping, unconditional jumps and nested MACRO program calls are supported by the module. More than 100 MACRO programs can be downloaded to the module and a MACRO program can contain up to 512 command lines. The MODBUS master can directly call a MACRO program for motion execution. In addition FRnet DI or motion events (e.g. position compare, start / finish of a constant speed drive, etc.) can trigger a MACRO program execution.

In addition the ET-M8194H acts as an FRnet master and can control up to 128 digital outputs and 128 digital inputs. FRnet is a two-wire serial bus and has a scan interval of 2.88 ms and it is specifically designed for easy and cost effective wiring. ICPDAS provides a large range of FRnet I/O terminal boards and modules.

An EzMove utility is provided for configuring the ET-M8194H and assisting the user in writing macro programs and in getting familiar with the ET-M8194H and its motion commands. Furthermore it can be used for motion monitoring and tracking of the motion path.

## 1.2 Function Categories

The ET-M8194H supports four types of commands:

**RTC** (Real Time Command): The functions are buffered on a FIFO buffer (DPRAM) and will be executed one by one in the sequence they have arrived. If the buffer is full the ET-M8194H will respond with a MB\_SLAVE\_DEVICE\_BUSY (0x06) exception.

**MP** (Macro Program): MP is a small compact motion program stored in a non-volatile memory of the i-8094H. Macro programs can be executed by calling MP\_CALL with its corresponding number.

**ISR** (Interrupt Service Routine): An ISR is similar to an MP. The ISR Macro program will be triggered by an interrupt of the motion chip. The motion chip supports different type of hardware interrupts, like compare. Each interrupt routine can be assigned to a different ISR macro program which will be executed once the corresponding interrupts occurs.

**IT** (Initial Table): During power on all the configuration made in the initial table will be set. The initial table is intended for initializing the motion chip.

The maximum number of program lines reserved for the MP and ISR Macro programs are listed in the following table.

ISR(6)	ISR1	ISR2	ISR3	ISR4	ISR5	ISR6			
<i>Total:</i>	8	8	8	8	8	8			
ISR(9)	ISR7	ISR8	ISR9	ISR10	ISR11	ISR12	ISR13	ISR14	ISR15
<i>Total:</i>	16	16	16	16	16	16	16	16	16
ISR(3)	ISR16	ISR17	ISR18						
<i>Total:</i>	32	32	32						
ISR(2)	ISR19	ISR20							
<i>Total:</i>	64	64							
MP(40)	MP1	~	MP40						
<i>Total:</i>	8		8						
MP(50)	MP41	~	MP90						
<i>Total:</i>	16		16						
MP(40)	MP91	~	MP130						
<i>Total:</i>	32		32						
MP(20)	MP131	~	MP150						

<b>Total:</b>	<b>64</b>		<b>64</b>		
<b>MP(5)</b>	<b>MP151</b>	<b>MP152</b>	<b>MP153</b>	<b>MP154</b>	<b>MP155</b>
<b>Total:</b>	<b>128</b>	<b>128</b>	<b>128</b>	<b>128</b>	<b>128</b>
<b>MP(2)</b>	<b>MP156</b>	<b>MP157</b>			
<b>Total:</b>	<b>512</b>	<b>512</b>			

**Note:**

- In the following chapters
  - ✖ indicates functions which are supported by Macro programs MP.
  - ▲ indicates functions which can be used inside ISR.
  
- In the following table
  - The mark ◎ indicates the function is available in that category.
  - ◎x2 means the function is available in that category with two MP function lines.

Table 1: Command types and command scope

Section	Function	RTC	MP	ISR	IT
<b>Basic Settings</b>					
3.2.1	ETM_RESET_CARD	◎			
3.2.2	ETM_CLEAR_CARD_BUFFER	◎			
3.3	ETM_SET_PULSE_MODE	◎			◎
3.3	ETM_MACRO_SET_PULSE_MODE		◎		◎
3.4	ETM_SET_MAX_V	◎			◎
3.4	ETM_MACRO_SET_MAX_V		◎		◎
3.5	ETM_SET_HLMT	◎			◎
3.5	ETM_MACRO_SET_HLMT		◎		◎
3.6	ETM_LIMITSTOP_MODE	◎			◎
3.6	ETM_MACRO_LIMITSTOP_MODE		◎		◎
3.7	ETM_SET_NHOME	◎			◎
3.7	ETM_MACRO_SET_NHOME		◎		◎
3.8	ETM_SET_HOME_EDGE	◎			◎
3.8	ETM_MACRO_SET_HOME_EDGE		◎		◎
3.9.1	ETM_SET_SLMT	◎			◎
3.9.1	ETM_MACRO_SET_SLMT		◎		◎
3.9.2	ETM_CLEAR_SLMT	◎			◎

Section	Function	RTC	MP	ISR	IT
3.9.2	ETM_MACRO_CLEAR_SLMT		⊙		⊙
3.10	ETM_SET_ENCODER	⊙			⊙
3.10	ETM_MACRO_SET_ENCODER		⊙		⊙
3.11.1	ETM_SERVO_ON	⊙			⊙
3.11.1	ETM_MACRO_SERVO_ON		⊙		⊙
3.11.2	ETM_SERVO_OFF	⊙			⊙
3.11.2	ETM_MACRO_SERVO_OFF		⊙		⊙
3.12	ETM_SET_ALARM	⊙			⊙
3.12	ETM_MACRO_SET_ALARM		⊙		⊙
3.13	ETM_SET_INPOS	⊙			⊙
3.13	ETM_MACRO_SET_INPOS		⊙		⊙
3.14	ETM_SET_FILTER	⊙			⊙
3.14	ETM_MACRO_SET_FILTER		⊙		⊙
3.15.1	ETM_VRING_ENABLE	⊙			⊙
3.15.1	ETM_MACRO_VRING_ENABLE		⊙		⊙
3.15.2	ETM_VRING_DISABLE	⊙			⊙
3.15.2	ETM_MACRO_VRING_DISABLE		⊙		⊙
3.16.1	ETM_AVTRI_ENABLE	⊙			⊙
3.16.1	ETM_MACRO_AVTRI_ENABLE		⊙		⊙
3.16.2	ETM_AVTRI_DISABLE	⊙			⊙
3.16.2	ETM_MACRO_AVTRI_DISABLE		⊙		⊙
3.17.1	ETM_EXD_MP	⊙			
3.17.2	ETM_EXD_FP	⊙			
3.17.3	ETM_EXD_CP	⊙			
3.17.4	ETM_EXD_DISABLE	⊙			
3.18.1	ETM_READ_bVAR	⊙			
3.18.2	ETM_WRITE_bVAR	⊙			
3.18.3	ETM_READ_VAR	⊙			
3.18.4	ETM_WRITE_VAR	⊙			
3.19.1	ETM_READ_MD	⊙			
3.19.2	ETM_WRITE_MD	⊙			
<b>Motion Controller Status</b>					
4.1.1	ETM_SET_LP	⊙			
4.1.1	ETM_MACRO_SET_LP		⊙	⊙	
4.1.2	ETM_GET_LP	⊙			

Section	Function	RTC	MP	ISR	IT
4.1.2	ETM_MACRO_GET_LP		⊙	⊙	
4.1.2	ETM_GET_LP_4_AXIS	⊙			
4.2.1	ETM_SET_EP	⊙			
4.2.1	ETM_MACRO_SET_EP		⊙	⊙	
4.2.2	ETM_GET_EP	⊙			
4.2.2	ETM_MACRO_GET_EP		⊙	⊙	
4.2.2	ETM_GET_EP_4_AXIS	⊙			
4.3.1	ETM_ABS_SET_POSITION	⊙			
4.3.1	ETM_MACRO_ABS_SET_POSITION		⊙	⊙	
4.3.2	ETM_ABS_GET_POSITION	⊙			
4.3.2	ETM_MACRO_ABS_GET_POSITION		⊙	⊙	
4.3.2	ETM_ABS_GET_POSITION_4_AXIS	⊙			
4.4	ETM_GET_CV	⊙			
4.4	ETM_GET_CV_4_AXIS	⊙			
4.5	ETM_GET_CA	⊙			
4.5	ETM_GET_CA_4_AXIS	⊙			
4.6.1	ETM_MACRO_GET_DI		⊙	⊙	
4.6.2	ETM_GET_DI_ALL	⊙			
4.6.2	ETM_MACRO_GET_DI_ALL		⊙	⊙	
4.6.2	ETM_GET_DI_ALL_4_AXIS	⊙			
4.7.1	ETM_MACRO_GET_DI_SIGNAL		⊙	⊙	
4.7.2	ETM_GET_DI_SIGNAL_ALL	⊙			
4.7.2	ETM_MACRO_GET_DI_SIGNAL_ALL		⊙	⊙	
4.7.2	ETM_GET_DI_SIGNAL_ALL_4_AXIS	⊙			
4.8	ETM_GET_HOME_SEARCH_STATE	⊙			
4.8	ETM_MACRO_GET_HOME_SEARCH_STATE		⊙	⊙	
4.8	ETM_GET_HOME_SEARCH_STATE_4_AXIS	⊙			
4.9.1	ETM_GET_ERROR_STATE	⊙			
4.9.1	ETM_MACRO_GET_ERROR		⊙	⊙	
4.9.2	ETM_GET_ERROR_CODE	⊙			
4.9.2	ETM_MACRO_GET_ERROR_CODE		⊙	⊙	
4.9.2	ETM_GET_ERROR_CODE_4_AXIS	⊙			
4.10	ETM_GET_FREE_BUFFER	⊙			
4.11	ETM_GET_STOP_STATUS	⊙			
4.11	ETM_GET_STOP_STATUS_4_AXIS	⊙			

Section	Function	RTC	MP	ISR	IT
4.12	ETM_GET_EMERGENCY_STATE	⊙			
4.13	ETM_GET_DRIVING_AXIS	⊙			
4.14	ETM_GET_INTERPOL_RDY_FLAG	⊙			
4.15	ETM_GET_TRIG_INTFACTOR	⊙			
4.16.2	ETM_GET_DEVICE_STATE	⊙			
<b>FRnet Functions</b>					
5.1.1	ETM_MACRO_FRNET_IN		⊙	⊙	
5.1.2	ETM_MACRO_FRNET_READ		⊙	⊙	
5.1.3	ETM_FRNET_READ_SINGLE_DIO	⊙			
5.1.4	ETM_FRNET_READ_GROUP_DIO	⊙			
5.1.5	ETM_FRNET_READ_MULTI_GROUP_DIO	⊙			
5.2.1	ETM_MACRO_FRNET_OUT		⊙	⊙	
5.2.2	ETM_MACRO_FRNET_WRITE		⊙	⊙	
5.2.3	ETM_FRNET_WRITE_SINGLE_DO	⊙			
5.2.4	ETM_FRNET_WRITE_GROUP_DO	⊙			
5.2.5	ETM_FRNET_WRITE_MULTI_GROUP_DO	⊙			
5.3	ETM_MACRO_FRNET_WAIT		⊙	⊙	
5.4	ETM_SET_FRNET_TRIGGER_EVENT	⊙			
5.5	ETM_GET_FRNET_TRIGGER_EVENT_SETTING	⊙			
<b>Auto Homing Search</b>					
6.1	ETM_SET_HV	⊙			
6.1	ETM_MACRO_SET_HV		⊙		
6.2	ETM_HOME_LIMIT	⊙			
6.2	ETM_MACRO_HOME_LIMIT		⊙		
6.3	ETM_SET_HOME_MODE	⊙			
6.3	ETM_MACRO_SET_HOME_MODE		⊙		
6.4	ETM_HOME_START	⊙			
6.4	ETM_MACRO_HOME_START		⊙		
<b>Motion Control Commands</b>					
7.1.1	ETM_NORMAL_SPEED	⊙			
7.1.1	ETM_MACRO_NORMAL_SPEED		⊙	⊙	
7.1.2	ETM_SET_SV	⊙			
7.1.2	ETM_MACRO_SET_SV		⊙	⊙	
7.1.3	ETM_SET_V	⊙			
7.1.3	ETM_MACRO_SET_V		⊙	⊙	
7.1.4	ETM_SET_A	⊙			
7.1.4	ETM_MACRO_SET_A		⊙	⊙	
7.1.5	ETM_SET_D	⊙			
7.1.5	ETM_MACRO_SET_D		⊙	⊙	
7.1.6	ETM_SET_K	⊙			

Section	Function	RTC	MP	ISR	IT
7.1.6	ETM_MACRO_SET_K		⊙	⊙	
7.1.7	ETM_SET_L	⊙			
7.1.7	ETM_MACRO_SET_L		⊙	⊙	
7.1.8	ETM_SET_AO	⊙			
7.1.8	ETM_MACRO_SET_AO		⊙	⊙	
7.1.9	ETM_FIXED_MOVE	⊙			
7.1.9	ETM_MACRO_FIXED_MOVE		⊙	⊙	
7.1.10	ETM_SET_PULSE	⊙			
7.1.10	ETM_MACRO_SET_PULSE		⊙	⊙	
7.1.11	ETM_ABS_FIXED_MOVE	⊙			
7.1.11	ETM_ABS_MACRO_FIXED_MOVE		⊙	⊙	
7.1.12	ETM_CONTINUE_MOVE	⊙			
7.1.12	ETM_MACRO_CONTINUE_MOVE		⊙	⊙	
7.2.1	ETM_AXIS_ASSIGN	⊙			
7.2.1	ETM_MACRO_AXIS_ASSIGN		⊙	⊙	
7.2.2	ETM_VECTOR_SPEED	⊙			
7.2.2	ETM_MACRO_VECTOR_SPEED		⊙	⊙	
7.2.3	ETM_SET_VSV	⊙			
7.2.3	ETM_MACRO_SET_VSV		⊙	⊙	
7.2.4	ETM_SET_VV	⊙			
7.2.4	ETM_MACRO_SET_VV		⊙	⊙	
7.2.5	ETM_SET_VA	⊙			
7.2.5	ETM_MACRO_SET_VA		⊙	⊙	
7.2.6	ETM_SET_VD	⊙			
7.2.6	ETM_MACRO_SET_VD		⊙	⊙	
7.2.7	ETM_SET_VK	⊙			
7.2.7	ETM_MACRO_SET_VK		⊙	⊙	
7.2.8	ETM_SET_VL	⊙			
7.2.8	ETM_MACRO_SET_VL		⊙	⊙	
7.2.9	ETM_SET_VAO	⊙			
7.2.9	ETM_MACRO_SET_VAO		⊙	⊙	
7.2.10	ETM_LINE_2D	⊙			
7.2.10	ETM_MACRO_LINE_2D		⊙	⊙	
7.2.11	ETM_ABS_LINE_2D	⊙			
7.2.11	ETM_ABS_MACRO_LINE_2D		⊙	⊙	
7.2.12	ETM_LINE_3D	⊙			
7.2.12	ETM_MACRO_LINE_3D		⊙	⊙	
7.2.13	ETM_ABS_LINE_3D	⊙			
7.2.13	ETM_ABS_MACRO_LINE_3D		⊙	⊙	
7.2.14	ETM_ARC_CW	⊙x2			
7.2.14	ETM_MACRO_ARC_CW		⊙x2	⊙x2	
7.2.15	ETM_ARC_CCW	⊙x2			
7.2.15	ETM_MACRO_ARC_CCW		⊙x2	⊙x2	
7.2.16	ETM_ABS_ARC_CW	⊙x2			
7.2.16	ETM_ABS_MACRO_ARC_CW		⊙x2	⊙x2	
7.2.17	ETM_ABS_ARC_CCW	⊙x2			



Section	Function	RTC	MP	ISR	IT
7.2.17	ETM_ABS_MACRO_ARC_CCW		⊙x2	⊙x2	
7.2.18	ETM_CIRCLE_CW	⊙			
7.2.18	ETM_MACRO_CIRCLE_CW		⊙	⊙	
7.2.19	ETM_CIRCLE_CCW	⊙			
7.2.19	ETM_MACRO_CIRCLE_CCW		⊙	⊙	
7.3.1	ETM_SYNC_ACTION	⊙x2			
7.3.1	ETM_MACRO_SYNC_ACTION		⊙x2	⊙x2	
7.3.2	ETM_CLEAR_SYNC_ACTION	⊙			
7.3.2	ETM_MACRO_CLEAR_SYNC_ACTION		⊙	⊙	
7.3.3	ETM_SET_ACTIVATION_FACTORS	⊙			
7.3.3	ETM_MACRO_SET_ACTIVATION_FACTORS		⊙	⊙	
7.3.4	ETM_SET_ACTIVATION_AXIS	⊙			
7.3.4	ETM_MACRO_SET_ACTIVATION_AXIS		⊙	⊙	
7.3.5	ETM_SET_ACTION	⊙			
7.3.5	ETM_MACRO_SET_ACTION		⊙	⊙	
7.3.6	ETM_SET_COMPARE	⊙			
7.3.6	ETM_MACRO_SET_COMPARE		⊙	⊙	
7.3.7	ETM_GET_LATCH	⊙			
7.3.7	ETM_MACRO_GET_LATCH		⊙	⊙	
7.3.7	ETM_GET_LATCH_4_AXIS	⊙			
7.3.8	ETM_SET_PRESET	⊙			
7.3.8	ETM_MACRO_SET_PRESET		⊙	⊙	
7.3.9	ETM_SET_OUT	⊙			
7.3.9	ETM_MACRO_SET_OUT		⊙	⊙	
7.3.10	ETM_ENABLE_INT	⊙			
7.3.10	ETM_MACRO_ENABLE_INT		⊙		
7.3.11	ETM_DISABLE_INT	⊙			
7.3.11	ETM_MACRO_DISABLE_INT		⊙		
7.3.12	ETM_INTFACTOR_ENABLE	⊙			
7.3.12	ETM_MACRO_INTFACTOR_ENABLE		⊙	⊙	
7.3.13	ETM_INTFACTOR_DISABLE	⊙			
7.3.13	ETM_MACRO_INTFACTOR_DISABLE		⊙	⊙	
7.4.1	ETM_RECTANGLE	⊙x4			
7.4.1	ETM_MACRO_RECTANGLE		⊙x4		
7.4.2	ETM_LINE_2D_INITIAL	⊙x2			
7.4.2	ETM_MACRO_LINE_2D_INITIAL		⊙x2		
7.4.3	ETM_LINE_2D_CONTINUE	⊙			
7.4.3	ETM_MACRO_LINE_2D_CONTINUE		⊙		
7.4.4	ETM_ABS_LINE_2D_CONTINUE	⊙			
7.4.4	ETM_ABS_MACRO_LINE_2D_CONTINUE		⊙		
7.4.5	ETM_LINE_3D_INITIAL	⊙x2			
7.4.5	ETM_MACRO_LINE_3D_INITIAL		⊙x2		
7.4.6	ETM_LINE_3D_CONTINUE	⊙			
7.4.6	ETM_MACRO_LINE_3D_CONTINUE		⊙		
7.4.7	ETM_ABS_LINE_3D_CONTINUE	⊙			
7.4.7	ETM_ABS_MACRO_LINE_3D_CONTINUE		⊙		

Section	Function	RTC	MP	ISR	IT
7.4.8	ETM_MIX_2D_INITIAL	⊙x2			
7.4.8	ETM_MACRO_MIX_2D_INITIAL		⊙x2		
7.4.9	ETM_MIX_2D_CONTINUE	⊙x2			
7.4.9	ETM_MACRO_MIX_2D_CONTINUE		⊙x2		
7.4.10	ETM_ABS_MIX_2D_CONTINUE	⊙x2			
7.4.10	ETM_ABS_MACRO_MIX_2D_CONTINUE		⊙x2		
7.4.11	ETM_HELIX_3D	⊙x3			
7.4.11	ETM_MACRO_HELIX_3D		⊙x3		
7.4.12	ETM_LINE_SCAN	⊙			
7.4.13	ETM_LINE_SCAN_START	⊙			
7.4.14	ETM_GET_LINE_SCAN_DONE	⊙			
7.5.1	ETM_DRV_HOLD	⊙			
7.5.1	ETM_MACRO_DRV_HOLD		⊙	⊙	
7.5.2	ETM_DRV_START	⊙			
7.5.2	ETM_MACRO_DRV_START		⊙	⊙	
7.5.3	ETM_STOP_SLOWLY	⊙			
7.5.3	ETM_MACRO_STOP_SLOWLY		⊙		
7.5.4	ETM_STOP_SUDDENLY	⊙			
7.5.4	ETM_MACRO_STOP_SUDDENLY		⊙		
7.5.5	ETM_VSTOP_SLOWLY	⊙			
7.5.5	ETM_MACRO_VSTOP_SLOWLY		⊙		
7.5.6	ETM_VSTOP_SUDDENLY	⊙			
7.5.6	ETM_MACRO_VSTOP_SUDDENLY		⊙		
7.5.7	ETM_CLEAR_STOP	⊙			
7.5.7	ETM_MACRO_CLEAR_STOP		⊙		
7.5.8	ETM_CLEAR_VSTOP	⊙			
7.5.8	ETM_MACRO_CLEAR_VSTOP		⊙		
7.5.9	ETM_INTP_END	⊙			
7.5.9	ETM_MACRO_INTP_END		⊙		
7.5.10	ETM_EMERGENCY_STOP	⊙			
7.5.11	ETM_CLEAR_EMERGENCY_STOP	⊙			
<b>Initial Parameter Table</b>					
8.1	ETM_LOAD_INITIAL	⊙			
<b>Macro Programming</b>					
9.1.1	ETM_MP_CREATE	⊙			
9.1.2	ETM_MACRO_MP_CLOSE		⊙		
9.1.3	ETM_MP_CALL	⊙			
9.1.3	ETM_MACRO_MP_CALL		⊙		
9.2.1	ETM_MP_ISR_CREATE	⊙			
9.2.2	ETM_MACRO_MP_ISR_CLOSE			⊙	
9.2.3	ETM_MP_ISR_CALL	⊙			
9.3.1	ETM_MACRO_SET_VAR		⊙	⊙	
9.3.2	ETM_MACRO_SET_RVAR		⊙	⊙	
9.4	ETM_MACRO_VAR_CALCULATE		⊙	⊙	
9.5.1	ETM_MACRO_FOR		⊙		

Section	Function	RTC	MP	ISR	IT
9.5.2	ETM_MACRO_NEXT		⊙		
9.5.3	ETM_MACRO_EXIT_FOR		⊙		
9.6.1	ETM_MACRO_IF		⊙	⊙	
9.6.2	ETM_MACRO_ELSE		⊙	⊙	
9.6.3	ETM_MACRO_END_IF		⊙	⊙	
9.7.1	ETM_MACRO_GOTO		⊙		
9.7.2	ETM_MACRO_LABEL		⊙		
9.8	ETM_MACRO_TIMER		⊙		
9.9	ETM_STOP_WAIT	⊙			
9.9	ETM_MACRO_STOP_WAIT		⊙		
9.10	ETM_MACRO_EXIT_MACRO		⊙	⊙	
9.11	ETM_MP_TERMINATE	⊙			
9.11	ETM_MACRO_MP_TERMINATE		⊙	⊙	
9.12	ETM_GET_MP_DOWNLOAD_STATUS	⊙			
9.13	ETM_CHANGE_VEL_ON_FLY	⊙			
<b>Library Version</b>					
11.1	ETM_GET_ETM8194H_FIRMWARE_VERSION	⊙			
11.2	ETM_GET_i8094H_FIRMWARE_VERSION	⊙			
11.3	ETM_GET_DLL_VERSION	⊙			

## 1.3 API Command Modbus Setup

Function\_name (parameter1, parameter2 .....)

Description: Explanation of this function.

Category: Function categories description.

Parameters: Definitions of the parameters and how to use them.

Return: The return value of this function.

Example: Simple example program.

Remark: Comments.

MODBUS Register Table:

The MODBUS TCP telegram for the commands is defined as follows:

- (1) **TID**: Transaction ID.
- (2) **PID**: Protocol ID.
- (3) **Field Length**: Length of data-field (in Byte). The data-field begins from UID and end at last Register.
- (4) **UID**: Unit ID (CardNo).
- (5) **FC**: Function Code.
- (6) **St\_Addr.**: Starting Address.
- (7) **Word Count**: The length of the following Registers (in Word, 16-bit).
- (8) **Byte Count**: The length of the following Registers (in Byte, 8-bit).
- (9) **Register**: Content of parameter (16-bit).
  - (9-1) **Sub\_Function Code**: The pre-defined code for each ET-M8194H function.
  - (9-2) **Axis**: The target Axis/Axes of the ET-M8194H function.

The MODBUS Registers only support 16-bit data format. Therefore, two Registers represent a 32-bit value. If the WORD order is set to 0, the first register represents the high-WORD (MSW) and the second register the low-WORD (LSW).

---

## 2 Communication Functions

---

### 2.1 TCP/IP Communication Functions

In this chapter introduces function which enables the PC or any other device which acts as a Modbus TCP/IP master to create and close a TCP/IP connection to the ET-M8194H.

#### 2.1.1 Create TCP/IP Connection

```
HANDLE ETM_CONNECT(char* ip, DWORD dwMbusTimeout)
HANDLE ETM_CONNECT_W(wchar_t* IpAddr, DWORD dwMbusTimeout,
long IConTimeout)
```

#### Description:

Establish an Ethernet connection between PC and ET-M8194H. The connection is required before sending a MODBUS command. Although the ET-M8194H allows up to 29 Clients to connect to it simultaneously, it is suggested to just use one connection for motion control. Every connection returns a unique handle.

It is important to close the connection (ETM\_DISCONNECT() ) before the HANDLE goes out of scope otherwise internal memory reserved for this connection will not be release.

#### Parameters:

Paramters	Description
<i>ip:</i>	IP address of the target ET-M819H in ASCII format
<i>IpAddr</i>	IP address of target ET-M819H in Unicode format
<i>dwMbusTimeout</i>	Modbus communication timeout (milliseconds) (suggested value: 1000 – 2000 ms)
<i>IConTimeout</i>	Connection timeout (milliseconds) (suggested value: 10000 ms)

**Return:** INVALID\_HANDLE\_VALUE or NULL indicates a failed connction, other values indicates a successful connction.

**Example:** [VC++]  
`#include "ET_M8194H_API.h"`  
Handle hETM1, hETM2;  
`eRET iRet;`  
`hETM1 = ETM_Connect("192.168.0.1", 1000);`  
`iRet = ETM_SERVO_ON (hETM1, 1, AXIS_XYZU); //Set servo on`

## 2.1.2 Close TCP/IP Connection

**eRET ETM\_DISCONNECT (HANDLE *hEtm*)**

**Description:**

Close the established Ethernet connection and release internal memory assigned for the connection.

**Parameters:**

Parameters	Description
<i>hEtm</i> :	TCP/IP connection handle

**Return:** 0: Success; Others: Fail (Please refer to chapter 2.2)

### 2.1.3 Get TCP/IP Connection State

**eTCP\_CONNECT** ETM\_CONNECTION\_STATE (**HANDLE** *hEtm*)

**Description:**

Shows the status of Ethernet connection.

**Parameters:**

Parameters	Description
<i>hEtm</i> :	TCP/IP connection handle

**Return:** 1: Connected; 0: Disconnected

## 2.1.4 Modbus TCP Data

```
eRET ETM_MODBUS_CMD (HANDLE hEtm, char* Request, int Req_Len,  
char* Response, int* Res_Len)
```

### Description:

Send a Modbus TCP frame to the ET-M8194H. Profound Modbus knowledge is required in order use this command. This command does not need to be called for the ET-M8194H, because all the motion APIs described in this manual processes the Modbus communication inside the DLL provided for the ET-M8194H. Therefore by directly calling the motion APIs provided by the ET-M8194H DLL no Modbus knowledge is required.

### Parameters:

Paramters	Description
<i>hEtm:</i>	TCP/IP connection handle
<i>Request</i>	Modbus request frame
<i>Req_Len</i>	Length of the Modbus request
<i>Response</i>	Modbus response frame
<i>Res_Len</i>	Length of the Modbus response frame

**Return:** 0: Success; Others: Fail (Please refer to chapter 2.2)



## 2.1.5 Set Modbus TCP Register Order

```
eRET ETM_SET_WORD_ORDER (HANDLE hEtm, BYTE bWordOrder)
```

### Description:

Set the order of the most and least significant WORD (MSW, LSW). This function sets the WORD order of bytes variables (long, unsigned long, float) and determines the position of the first two and last two bytes in the Modbus table. The size of each Modbus register is two bytes long.

### Parameters:

Parameters	Description
<i>hEtm</i> :	TCP/IP connection handle
<i>bWordOrder</i>	0: MSW at the first Register 1: MSW at the second Register

**Return:** 0: Success; Others: Fail (Please refer to chapter 2.2)

## 2.1.6 Get Modbus TCP Register Order

```
eRET ETM_GET_WORD_ORDER (HANDLE hEtm, BYTE* pbWordOrder)
```

### Description:

Get the current Modbus register order setting for all the four byte variables.

### Parameters:

Parameters	Description
<i>hEtm:</i>	TCP/IP connection handle
<i>bWordOrder</i>	0: MSW at the first Register ; 1: MSW at the second Register

**Return:** 0: Success; Others: Fail (Please refer to chapter 2.2)

## 2.2 Communication Return Code

The return value (**eRET**) of each API call indicates whether a command has been sent successfully to the ET-M8194H:

Table 2: API return values

Communication Error	Code	Description
ETM_SUCCESS	0x00	Successful: command has been received by the ET-M8194H
MB_ILLEGAL_FUNCTION_CODE	0x01	The specified Modbus function code is not being supported.
MB_ILLEGAL_DATA_ADDRESS	0x02	Invalid starting-address of the MODBUS command. For instance, there are the two Registers are to be accessed (LP_X, LP_Y ...). If the WORD Order is set to be 1, then the starting-address is the Low_Word address.
MB_ILLEGAL_DATA_VALUE	0x03	Invalid data of MODBUS command, such as the number of parameters, the target-axis, the addresses of MD, VAR bVAR.  An API has been called which is not being supported by the ET-M8194H. Make sure that the API and ET-M8194H firmware version do match.
MB_SLAVE_DEVICE_FAILURE	0x04	Indicates that no i-8094H card is plugged into ET-M8194H.
MB_SLAVE_DEVICE_BUSY	0x06	Indicates the internal buffer (DPRAM-Buffer) of the i-8094H is full and the i8094H is still busy processing commands previously sent; Therefore the failed command has to be resend.
WRONG_CARD_NO	0x0B	Invalid card number. Currently only card number 1 is being supported
ETM_SOCKET_ERR	-1	Connection failed. The TCP/IP socket was closed. It is necessary to call the <b>ETM_CONNECT()</b> API again.
ETM_WRITE_DENY	-2	Indicates the writing command has

		been denied after the writing-protection feature has been enabled.
ETM_PAR_ERROR	-3	Indicates parameter value range error.
ETM_UNDEFINED_ERROR	-4	Indicates undefined error.
ETM_TIME_OUT	-5	The ET-M8194H did not respond within the specified timeout
ETM_INVALID_HANDLE	-6	Indicates an invalid handle
ETM_TRANS_ID_ERR	-7	This error occurs often after a response time out. It indicates that the respond frame does not correspond to the request frame.
ETM_FUNCTION_CODE_ERR	-8	Communication Error: The function code of the request and respond frame do not match.

## 3 Basic Settings

### 3.1 Axes Code Definition

The axis parameter definition is as follows: X=1, Y=2, Z=4 and U=8. The axis parameter of the APIs can be assigned a single axis and some APIs support multiple axes assignment.

For example if you assign an API the X and Y axes simultaneously, the code will be 3. In a similar way,  $AXIS\_YZ = 2+4 = 0x6$ ; and  $AXIS\_XYZU = 1+2+4+8 = 0xf$ .

Available axis codes are listed below:

Table 3: Axis assignments and their corresponding codes

Axis	X	Y	Z	U	XY	XZ	XU	YZ
Code	0x1	0x2	0x4	0x8	0x3	0x5	0x9	0x6
Variable	<a href="#">AXIS_X</a>	<a href="#">AXIS_Y</a>	<a href="#">AXIS_Z</a>	<a href="#">AXIS_U</a>	<a href="#">AXIS_XY</a>	<a href="#">AXIS_XZ</a>	<a href="#">AXIS_XU</a>	<a href="#">AXIS_YZ</a>
Axis	YU	ZU	XYZ	XYU	XZU	YZU	XYZU	
Code	0xa	0xc	0x7	0xb	0xd	0xe	0xf	
Variable	<a href="#">AXIS_YU</a>	<a href="#">AXIS_ZU</a>	<a href="#">AXIS_XYZ</a>	<a href="#">AXIS_XYU</a>	<a href="#">AXIS_XZU</a>	<a href="#">AXIS_YZU</a>	<a href="#">AXIS_XYZU</a>	

The motion initialization setting (IT-table, see chapter 8) can be saved to a non-volatile memory of the i-8094H by using the axis code defined in Table 4. These axis codes can not be used inside a macro program (MP or ISR):

Table 4: Axis assignments and their corresponding codes for initialization table (IT)

Axis	X	Y	Z	U	XY	XZ	XU	YZ
Code	0x11	0x12	0x14	0x18	0x13	0x15	0x19	0x16
Variable	<a href="#">INITIAL_X</a>	<a href="#">INITIAL_Y</a>	<a href="#">INITIAL_Z</a>	<a href="#">INITIAL_U</a>	<a href="#">INITIAL_XY</a>	<a href="#">INITIAL_XZ</a>	<a href="#">INITIAL_XU</a>	<a href="#">INITIAL_YZ</a>
Axis	YU	ZU	XYZ	XYU	XZU	YZU	XYZU	
Code	0x1a	0x1c	0x17	0x1b	0x1d	0x1e	0x1f	
Variable	<a href="#">INITIAL_YU</a>	<a href="#">INITIAL_ZU</a>	<a href="#">INITIAL_XYZ</a>	<a href="#">INITIAL_XYU</a>	<a href="#">INITIAL_XZU</a>	<a href="#">INITIAL_YZU</a>	<a href="#">INITIAL_XYZU</a>	

## 3.2 Motion Module Reset

### 3.2.1 Restore the Default Settings

```
eRET ETM_RESET_CARD (HANDLE hEtm, BYTE cardNo)
```

**Description:**

This function enables motion module (i-8094H) to restore the power-on default settings.

**Category:**

MODBUS sub\_function; RTC.

**Parameters:**

Paramters	Description
<i>hEtm:</i>	TCP/IP connection handle
<i>cardNo:</i>	1 (ET-M8194H supports only one i-8094H module)

**Return:**

0: Success; Others: Fail (Please refer to chapter 2.2)

**MODBUS example:**

ETM\_RESET\_CARD (hEtm, 1); *//Reset the module1*

The MODBUS command is listed as follows:

TID (hex)	PID (hex)	Field Length (hex)	UID (hex)	FC (hex)	St_Addr. (hex)	Word Count (hex)	Byte Count (hex)
00 01	00 00	00 09	01	10	1F 40	00 01	02
Register[]		Value (hex)		Remarks			
0		0A 0A		<i>Sub_function code</i>			

### 3.2.2 Clear Command Buffer

```
eRET ETM_CLEAR_CARD_BUFFER (HANDLE hEtm, BYTE cardNo)
```

**Description:**

Clear all data in i-8094H command buffer.

**Category:**

MODBUS sub\_function; RTC.

**Parameters:**

Paramters	Description
<i>hEtm</i> :	TCP/IP connection handle
<i>cardNo</i> :	1 (ET-M8194H supports only one i-8094H module)

**Return:**

0: Success; Others: Fail (Please refer to chapter 2.2)

**MODBUS example:**

```
ETM_CLEAR_CARD_BUFFER (hEtm, 1); //clear data buffer in module 1
```

**The MODBUS command is listed as follows:**

TID (hex)	PID (hex)	Field Length (hex)	UID (hex)	FC (hex)	St_Addr. (hex)	Word Count (hex)	Byte Count (hex)
00 01	00 00	00 09	01	10	1F 40	00 01	02
Register[]		Value (hex)		Remarks			
0		0A 0B		Sub_function code			

Use ETM\_GET\_FREE\_BUFFER function to get the available block-number inside the command buffer. The maximum block-number is 30).

### 3.3 Pules Output Mode Setting

**eRET ETM\_SET\_PULSE\_MODE (HANDLE *hEtm*, BYTE *cardNo*, BYTE *axis*, BYTE *nMode*)**

**✘ eRET ETM\_MACRO\_SET\_PULSE\_MODE (HANDLE *hEtm*, BYTE *cardNo*, BYTE *axis*, BYTE *nMode*)**

**Description:**

This function sets the pulse output mode to be either CW/CCW or PULSE/DIR for the specific axes and their direction.

**Category:**

MODBUS sub\_function; RTC, MP and IT.

**Parameters:**

Paramters	Description
<i>hEtm</i> :	TCP/IP connection handle
<i>cardNo</i> :	1 (ET-M8194H supports only one i-8094H module)
<i>axis</i> :	Axis or axes (Please refer to Table 3 or Table 4)  If <i>axis</i> setting is defined in Table 3, the setting values will change current settings.  If <i>axis</i> setting is defined in Table 4, the setting values will be writted into the parameter table without changing current settings.
<i>nMode</i> :	Assigned mode (Please refer to Table 5)

**Table 5: List of pulse output modes**

	mode	Pulse output signal	
		nPP	nPM
CW / CCW	0	CW(rising edge)	CCW(rising edge)
	1	CW(falling edge)	CCW(falling edge)
PULSE / DIR	2	PULSE (rising edge)	DIR (LOW:+dir/ HIGH:-dir)
	3	PULSE (falling edge)	DIR (LOW:+dir/ HIGH:-dir)
	4	PULSE (rising edge)	DIR (HIGH:+dir/ LOW:-dir)
	5	PULSE (falling edge)	DIR (HIGH:+dir/ LOW:-dir)



**Return:**

0: Success; Others: Fail (Please refer to chapter 2.2)

**Remark:**

The Sub\_function code of ETM\_SET\_PULSE\_MODE is 0A 0C.

The Sub\_function code of ETM\_MACRO\_SET\_PULSE\_MODE is 0C 0C.

**MODBUS example:**

ETM\_SET\_PULSE\_MODE (hEtm, 1, AXIS\_XYZ, 2);

// set the pulse mode of X, Y, and Z axes to be mode 2 for module 1

The MODBUS command is listed as follows:

TID (hex)	PID (hex)	Field Length (hex)	UID (hex)	FC (hex)	St_Addr. (hex)	Word Count (hex)	Byte Count (hex)
00 01	00 00	00 0D	01	10	1F 40	00 03	06
Register[]		Value (hex)		Remarks			
0		0A 0C/0C 0C		Sub_function code			
1		00 07		axis			
2		00 02		nMode			

**Example:**

ETM\_SET\_PULSE\_MODE (hEtm, 1, AXIS\_XYZ, 2);

// set the pulse mode of X, Y, and Z axes to be mode 2 in module 1

ETM\_SET\_PULSE\_MODE(hEtm, 1, AXIS\_U, 3);

//set the pulse mode of U axis to be mode 3 in module 1

ETM\_SET\_PULSE\_MODE (hEtm, 1, INITIAL\_XYZU, 0);

//set the pulse mode of X Y Z U axes to be mode 0, write into the initial parameter table (table 4) in module 1

## 3.4 Maximum Speed Setting

**eRET ETM\_SET\_MAX\_V (HANDLE *hEtm*, BYTE *cardNo*, BYTE *axis*,  
DWORD *data*)**

**※ eRET ETM\_MACRO\_SET\_MAX\_V (HANDLE *hEtm*, BYTE *cardNo*, BYTE  
*axis*, DWORD *data*)**

### Description:

This function sets the maximum rate for the output pulses (speed). A larger value results in a rougher resolution, and vice versa. There are 8000 speed segments available. For example, if the maximum speed is set as 8000 PPS, the resolution will be 1 PPS; if the maximum speed is set as 16000 PPS, the resolution will be 2 PPS; if the maximum speed is set as 80000 PPS, the resolution will be 10 PPS, etc. Maximum value 4,000,000 PPS means the resolution of speed will be 500 PPS. This function will change the resolution of speed to reach the desired maximum speed. Since the scale in hardware is changed, other parameters will be updated accordingly too; such as the starting speed, the acceleration, and the jerk. It is recommended to set the maximum speed value to be an integral multiplier of 8000.

### Category:

MODBUS sub\_function; RTC, MP and IT.

### Parameters:

Paramters	Description
<i>hEtm</i> :	TCP/IP connection handle
<i>cardNo</i>	1 (ET-M8194H supports only one i-8094H module)
<i>axis</i>	Axis or axes (Please refer to Table 3 or Table 4)  If <i>axis</i> setting is defined in Table 3, the setting values will change current settings.  If <i>axis</i> setting is defined in Table 4, the setting values will be writted into the parameter table without changing current settings.
<i>data</i>	Range of the maximum speed: single axis: 8,000~4,000,000 PPS; the second axis: 8,000~2,828,854 PPS; the third axis: 8,000~2,309,468 PPS.

**Return:**

0: Success; Others: Fail (Please refer to chapter 2.2)

**Remark:**

The Sub\_function code of ETM\_SET\_MAX\_V is 0A 0D.

The Sub\_function code of ETM\_MACRO\_SET\_MAX\_V is 0C 0D.

**MODBUS example:**

ETM\_SET\_MAX\_V (hEtm, 1, AXIS\_XY, 200000L);

//The maximum speed for the X and Y axes of module 1 is 200KPPS.

//The resolution of the speed will be 200000/8000 = 25 PPS.

**The MODBUS command is listed as follows:**

TID (hex)	PID (hex)	Field Length (hex)	UID (hex)	FC (hex)	St_Addr. (hex)	Word Count (hex)	Byte Count (hex)
00 01	00 00	00 0F	01	10	1F 40	00 04	08
Register[]		Value (hex)		Remarks			
0		0A 0D/0C 0D		<i>Sub_function code</i>			
1		00 03		<i>axis</i>			
2		00 03		<i>MSW of data</i>			
3		0D 40		<i>LSW of data (200000 = 0x30D40)</i>			

### 3.5 Trigger Level Setting of Hardware Limit Switch

```
eRET ETM_SET_HLMT (HANDLE hEtm, BYTE cardNo, BYTE axis, BYTE nFLEdge, BYTE nRLEdge)

※ eRET ETM_MACRO_SET_HLMT (HANDLE hEtm, BYTE cardNo, BYTE axis, BYTE nFLEdge, BYTE nRLEdge)
```

**Description:**

This function sets the active logic level of the hardware limit switch inputs.

**Category:**

MODBUS sub\_function; RTC, MP and IT.

**Parameters:**

Parameters	Description
<i>hEtm:</i>	TCP/IP connection handle
<i>cardNo:</i>	1 (ET-M8194H supports only one i-8094H module)
<i>axis:</i>	Axis or axes (Please refer to Table 3 or Table 4)  If <i>axis</i> setting is defined in Table 3, the setting values will change current settings.  If <i>axis</i> setting is defined in Table 4, the setting values will be writted into the parameter table without changing current settings.
<i>nFLEdge:</i>	Active level setting for the forward limit switch. 0 = low active; 1 = high active
<i>nRLEdge:</i>	Active level setting for the reverse limit switch. 0 = low active; 1 = high active

**Return:**

0: Success; Others: Fail (Please refer to chapter 2.2)

**Remark:**

The Sub\_function code of ETM\_SET\_HLMT is 0A 0E.  
The Sub\_function code of ETM\_MACRO\_SET\_HLMT is 0C 0E.

**MODBUS example:**

```
ETM_SET_HLMT (hEtm, 1, AXIS_XYZU, 0, 0);
//set all the trigger levels as low-active for all limit switches on module 1.
```

The MODBUS command is listed as follows:

TID (hex)	PID (hex)	Field Length (hex)	UID (hex)	FC (hex)	St_Addr. (hex)	Word Count (hex)	Byte Count (hex)
00 01	00 00	00 0F	01	10	1F 40	00 04	08
Register[]		Value (hex)		Remarks			
0		0A 0E/0C 0E		<i>Sub_function code</i>			
1		00 0F		<i>axis</i>			
2		00 00		<i>nFLEdge</i>			
3		00 00		<i>nRLEdge</i>			

### 3.6 Motion Stop Mode Setting of Limit Switch

```
eRET ETM_LIMITSTOP_MODE (HANDLE hEtm, BYTE cardNo, BYTE axis,
                           BYTE nMode)

※ eRET ETM_MACRO_LIMITSTOP_MODE (HANDLE hEtm, BYTE cardNo,
                                   BYTE axis, BYTE nMode)
```

**Description:**

This function configures the settings of motion stop mode of the axes when the corresponding limit switches being turn on.

**Category:**

MODBUS sub\_function; RTC, MP and IT.

**Parameters:**

Paramters	Description
<i>hEtm:</i>	TCP/IP connection handle
<i>cardNo:</i>	1 (ET-M8194H supports only one i-8094H module)
<i>axis:</i>	Axis or axes (Please refer to Table 3 or Table 4)  If <i>axis</i> setting is defined in Table 3, the setting values will change current settings.  If <i>axis</i> setting is defined in Table 4, the setting values will be writted into the parameter table without changing current settings.
<i>nMode:</i>	0: stop immediately; 1: decelerating to stop

**Return:**

0: Success; Others: Fail (Please refer to chapter 2.2)

**Remark:**

The Sub\_function code of ETM\_LIMITSTOP\_MODE is 0A 0F.  
The Sub\_function code of ETM\_MACRO\_LIMITSTOP\_MODE is 0C 0F.

**MODBUS example:**

```
ETM_LIMITSTOP_MODE (hEtm, 1, AXIS_X, 0);
//set X axis to stop immediately if any limit switch on X axis is turned on.
```

The MODBUS command is listed as follows:

TID (hex)	PID (hex)	Field Length (hex)	UID (hex)	FC (hex)	St_Addr. (hex)	Word Count (hex)	Byte Count (hex)
00 01	00 00	00 0D	01	10	1F 40	00 03	06
Register[]		Value (hex)		Remarks			
0		0A 0F/0C 0F		<i>Sub_function code</i>			
1		00 01		<i>axis</i>			
2		00 00		<i>nMode</i>			

### 3.7 Trigger Level Setting of Near Home Sensor

<p><b>eRET ETM_SET_NHOME (HANDLE <i>hEtm</i>, BYTE <i>cardNo</i>, BYTE <i>axis</i>, BYTE <i>nNHEdge</i>)</b></p> <p><b>※ eRET ETM_MACRO_SET_NHOME (HANDLE <i>hEtm</i>, BYTE <i>cardNo</i>, BYTE <i>axis</i>, BYTE <i>nNHEdge</i>)</b></p>
---

**Description:**

This function enables to set up the trigger level of the near home sensor (NHOME).

**Category:**

MODBUS sub\_function; RTC, MP and IT.

**Parameters:**

Paramters	Description
<i>hEtm</i> :	TCP/IP connection handle
<i>cardNo</i> :	1 (ET-M8194H supports only one i-8094H module)
<i>axis</i> :	Axis or axes (Please refer to Table 3 or Table 4)  If <i>axis</i> setting is defined in Table 3, the setting values will change current settings.  If <i>axis</i> setting is defined in Table 4, the setting values will be writted into the parameter table without changing current settings.
<i>nNHEdge</i> :	Active level setting for for the near home sensor 0 = low active; 1 = high active

**Return:**

0: Success; Others: Fail (Please refer to chapter 2.2)

**Remark:**

The Sub\_function code of ETM\_SET\_NHOME is 0A 10.  
The Sub\_function code of ETM\_MACRO\_SET\_NHOME is 0C 10.

**MODBUS example:**

```
ETM_SET_NHOME (hEtm, 1, AXIS_XY, 0);
// set the trigger level of NHOME of X and Y axes on module 1 to be active low.
```



The MODBUS command is listed as follows:

TID (hex)	PID (hex)	Field Length (hex)	UID (hex)	FC (hex)	St_Addr. (hex)	Word Count (hex)	Byte Count (hex)
00 01	00 00	00 0D	01	10	1F 40	00 03	06
Register[]		Value (hex)		Remarks			
0		0A 10/0C 10		Sub_function code			
1		00 03		Axis (3 → AXIS_XY)			
2		00 00		nNHEdge			

### 3.8 Trigger Level Setting of Home Sensor

```
eRET ETM_SET_HOME_EDGE (HANDLE hEtm, BYTE cardNo, BYTE axis, BYTE nHEdge)
※ eRET ETM_MACRO_SET_HOME_EDGE (HANDLE hEtm, BYTE cardNo, BYTE axis, BYTE nHEdge)
```

**Description:**

This function sets the trigger level of the home sensor (HOME)

**Category:**

MODBUS sub\_function; RTC, MP and IT.

**Parameters:**

Parameters	Description
<i>hEtm:</i>	TCP/IP connection handle
<i>cardNo:</i>	1 (ET-M8194H supports only one i-8094H module)
<i>axis:</i>	Axis or axes (Please refer to Table 3 or Table 4)  If <i>axis</i> setting is defined in Table 3, the setting values will change current settings.  If <i>axis</i> setting is defined in Table 4, the setting values will be writted into the parameter table without changing current settings.
<i>nHEdge:</i>	Active level setting for the home sensor 0 = low active; 1 = high active

**Return:**

0: Success; Others: Fail (Please refer to chapter 2.2)

**Remark:**

The Sub\_function code of ETM\_SET\_HOME\_EDGE is 0A 11.

The Sub\_function code of ETM\_MACRO\_SET\_HOME\_EDGE is 0C 11.

**MODBUS example:**

```
ETM_SET_HOME_EDGE (hEtm, 1, AXIS_XYZU, 1);
```

```
//set the trigger level as high active for all home sensors on module 1
```

The MODBUS command is listed as follows:

TID (hex)	PID (hex)	Field Length (hex)	UID (hex)	FC (hex)	St_Addr. (hex)	Word Count (hex)	Byte Count (hex)
00 01	00 00	00 0D	01	10	1F 40	00 03	06
Register[]		Value (hex)		Remarks			
0		0A 11/0C 11		<i>Sub_function code</i>			
1		00 0F		<i>Axis (F → AXIS_XYZU)</i>			
2		00 01		<i>nHEdge</i>			

## 3.9 Software Limit Setting

### 3.9.1 Set the Software Limit Value

<b>eRET ETM_SET_SLMT (HANDLE <i>hEtm</i>, BYTE <i>cardNo</i>, BYTE <i>axis</i>, long <i>dwFL</i>, long <i>dwRL</i>, BYTE <i>nType</i>)</b>
<b>※ eRET ETM_MACRO_SET_SLMT (HANDLE <i>hEtm</i>, BYTE <i>cardNo</i>, BYTE <i>axis</i>, long <i>dwFL</i>, long <i>dwRL</i>, BYTE <i>nType</i>)</b>

**Description:**

This function sets the positive and negative software limits.

**Category:**

MODBUS sub\_function; RTC, MP and IT.

**Parameters:**

Paramters	Description
<i>hEtm</i> :	TCP/IP connection handle
<i>cardNo</i> :	1 (ET-M8194H supports only one i-8094H module)
<i>axis</i> :	Axis or axes (Please refer to Table 3 or Table 4)  If <i>axis</i> setting is defined in Table 3, the setting values will change current settings.  If <i>axis</i> setting is defined in Table 4, the setting values will be writted into the parameter table without changing current settings.
<i>dwFL</i> :	Value of the forward software limit (-2,000,000,000 ~ +2,000,000,000)
<i>dwRL</i> :	Value of the reverse software limit (-2,000,000,000 ~ +2,000,000,000)
<i>nType</i> :	Position counter to be compared 0 = logical position counter (LP), i.e., the command position 1 = encoder position counter (EP), i.e., the real position

**Return:**

0: Success; Others: Fail (Please refer to chapter 2.2)

**Remark:**

The Sub\_function code of ETM\_SET\_SLMT is 0A 12.

The Sub\_function code of ETM\_MACRO\_SET\_SLMT is 0C 12.

**MODBUS example:**

**ETM\_SET\_SLMT (hEtm, 1, AXIS\_XYZU, 20000, -3000, 0);**

**//set the forward software limit to be 20000 and the reverse**

**// software limit to be -3000 for all axes on module 1.**

The MODBUS command is listed as follows:

TID (hex)	PID (hex)	Field Length (hex)	UID (hex)	FC (hex)	St_Addr. (hex)	Word Count (hex)	Byte Count (hex)
00 01	00 00	00 15	01	10	1F 40	00 07	0E
Register[]		Value (hex)		Remarks			
0		0A 12/0C 12		<i>Sub_function code</i>			
1		00 0F		<i>axis</i>			
2		00 00		<i>MSW of dwFL</i>			
3		4E 20		<i>LSW of dwFL (20000 → 0x4E20)</i>			
4		FF FF		<i>MSW of dwRL</i>			
5		F4 48		<i>LSW of dwRL (-3000 → 0xFFFFF448)</i>			
6		00 00		<i>nType</i>			

### 3.9.2 Clear the Software Limit Value

<b>eRET ETM_CLEAR_SLMT (HANDLE <i>hEtm</i>, BYTE <i>cardNo</i>, BYTE <i>axis</i>)</b>
<b>✘ eRET ETM_MACRO_CLEAR_SLMT (HANDLE <i>hEtm</i>, BYTE <i>cardNo</i>, BYTE <i>axis</i>)</b>

**Description:**

This function clears the software limits.

**Category:**

MODBUS sub\_function; RTC, MP and IT.

**Parameters:**

Paramters	Description
<i>hEtm</i> :	TCP/IP connection handle
<i>cardNo</i> :	1 (ET-M8194H supports only one i-8094H module)
<i>axis</i> :	Axis or axes (Please refer to Table 3 or Table 4)  If <i>axis</i> setting is defined in Table 3, the setting values will change current settings.  If <i>axis</i> setting is defined in Table 4, the setting values will be writted into the parameter table without changing current settings.

**Return:**

0: Success; Others: Fail (Please refer to chapter 2.2)

**Remark:**

The Sub\_function code of ETM\_CLEAR\_SLMT is 0A 13.

The Sub\_function code of ETM\_MACRO\_CLEAR\_SLMT is 0C 13.

**MODBUS example:**

ETM\_CLEAR\_SLMT (*hEtm*, 1, AXIS\_XYZU);

//clear the software limits for all axes on module 1.

The MODBUS command is listed as follows:

TID (hex)	PID (hex)	Field Length (hex)	UID (hex)	FC (hex)	St_Addr. (hex)	Word Count (hex)	Byte Count (hex)
00 01	00 00	00 0B	01	10	1F 40	00 02	04
Register[]		Value (hex)		Remarks			
0		0A 13/0C 13		Sub_function code			
1		00 0F		Axis (F → AXIS_XYZU)			

## 3.10 Encoder Related Parameter Settings

<p><b>eRET ETM_SET_ENCODER (HANDLE <i>hEtm</i>, BYTE <i>cardNo</i>, BYTE <i>axis</i>, BYTE <i>nMode</i>, BYTE <i>nDivision</i>, BYTE <i>nZEdge</i>)</b></p> <p><b>✘ eRET ETM_MACRO_SET_ENCODER (HANDLE <i>hEtm</i>, BYTE <i>cardNo</i>, BYTE <i>axis</i>, BYTE <i>nMode</i>, BYTE <i>nDivision</i>, BYTE <i>nZEdge</i>)</b></p>
---

### Description:

This function sets the relevant parameters for encoder input.

### Category:

MODBUS sub\_function; RTC, MP and IT.

### Parameters:

Parameters	Description
<b><i>hEtm</i>:</b>	TCP/IP connection handle
<b><i>cardNo</i>:</b>	1 (ET-M8194H supports only one i-8094H module)
<b><i>axis</i>:</b>	Axis or axes (Please refer to Table 3 or Table 4)  If <i>axis</i> setting is defined in Table 3, the setting values will change current settings.  If <i>axis</i> setting is defined in Table 4, the setting values will be writted into the parameter table without changing current settings.
<b><i>nMode</i>:</b>	Encoder input type: 0 = A/B quadrature pulse (Count up when A-phase is advancing) 1 = up/down pulse ( A-phase is for counter up) 2 = A/B quadrature pulse (Count up when B-phase is advancing) 3 = up/down pulse ( B-phase is for counter up)
<b><i>nDivision</i>:</b>	Division setting for A/B quadrature input signals: 0 = 1/1 1 = 1/2 2 = 1/4
<b><i>nZEdge</i>:</b>	Sets the trigger level for the Z phase 0 = low active 1 = high active



**A/B quadrature pulse input mode:**

The count is incremented and decremented at the rising edge and falling edge of both signals. In A/B quadrature pulse input mode, the input pulses can be divided into 1/2 or 1/4.

**nMode = 0:**

When A-phase is advancing with positive logical pulses, the count is incremented; and when the B-phase is advancing, the count is decremented.

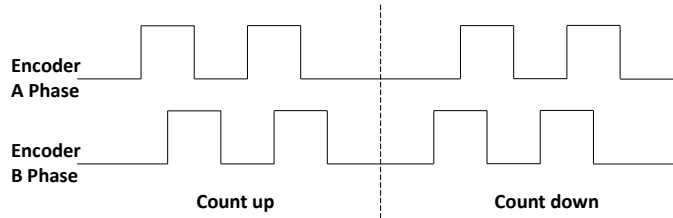

**nMode = 2:**

When B-phase is advancing with positive logical pulses, the count is incremented; and when the A-phase is advancing, the count is decremented.

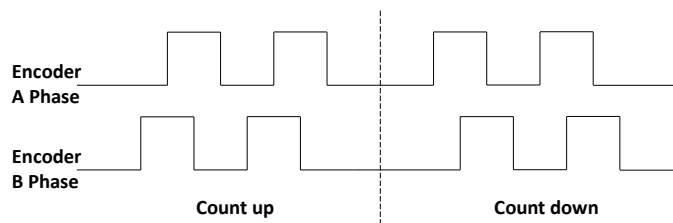

**Up/down pulse input mode:**

The counter counts at the rising edge of the positive pulse.

**nMode = 1:**

A-phase is count up input and B-phase is count down input.

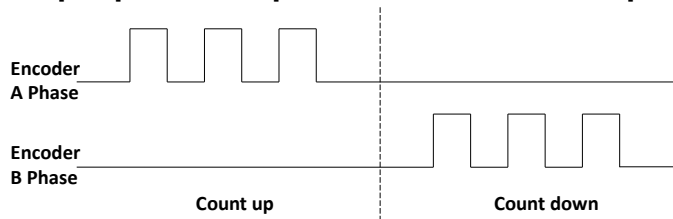

**nMode = 3:**

B-phase is count up input and A-phase is count down input.

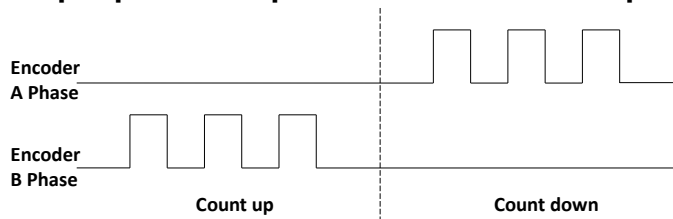

**Division setting for A/B quadrature input signals:**

nDivision = 0: Counting positive and negative edge of encoder A-phase and B-phase.

nDivision = 1: Counting positive and negative edge of the encoder A-phase only.

nDivision = 2: Considering the positive edge of the encoder A-phase only.

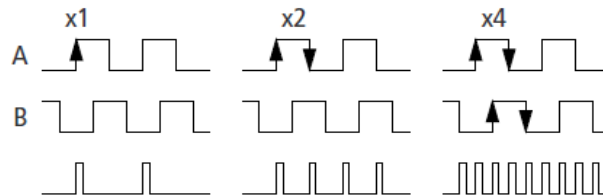

**Return:**

0: Success; Others: Fail (Please refer to chapter 2.2)

**Remark:**

The Sub\_function code of ETM\_SET\_ENCODER is 0A 14.

The Sub\_function code of ETM\_MACRO\_SET\_ENCODER is 0C 14.

**MODBUS example:**

ETM\_SET\_ENCODER (hEtm, 1, AXIS\_XYZU, 0, 0, 0);

//set the encoder input type as A quad B; the division setting is 1/1; and the Z phase is low active.

**The MODBUS command is listed as follows:**

TID (hex)	PID (hex)	Field Length (hex)	UID (hex)	FC (hex)	St_Addr. (hex)	Word Count (hex)	Byte Count (hex)
00 01	00 00	00 11	01	10	1F 40	00 05	0A
Register[]		Value (hex)		Remarks			
0		0A 14/0C 14		Sub_function code			
1		00 0F		axis (F → AXIS_XYZU)			
2		00 00		nMode (0 → AB phase)			
3		00 00		nDivision (0 → 1:1)			
4		00 00		nZEdge (0 → Z phase is low-active)			

## 3.11 Servo Driver (ON/OFF) Setting

### 3.11.1 Servo On

<code>eRET ETM_SERVO_ON (HANDLE <i>hEtm</i>, BYTE <i>cardNo</i>, BYTE <i>axis</i>)</code>
<code>※ eRET ETM_MACRO_SERVO_ON (HANDLE <i>hEtm</i>, BYTE <i>cardNo</i>, BYTE <i>axis</i>)</code>

**Description:**

This function outputs a DO signal to enable the motor driver.

**Category:**

MODBUS sub\_function; RTC, MP and IT.

**Parameters:**

Parameters	Description
<i>hEtm</i> :	TCP/IP connection handle
<i>cardNo</i> :	1 (ET-M8194H supports only one i-8094H module)
<i>axis</i> :	Axis or axes (Please refer to Table 3 or Table 4)  If <i>axis</i> setting is defined in Table 3, the setting values will change current settings.  If <i>axis</i> setting is defined in Table 4, the setting values will be writted into the parameter table without changing current settings.

**Return:**

0: Success; Others: Fail (Please refer to chapter 2.2)

**Remark:**

The Sub\_function code of ETM\_SERVO\_ON is 0A 15.  
The Sub\_function code of ETM\_MACRO\_SERVO\_ON is 0C 15.

**MODBUS example:**

```
ETM_SERVO_ON (hEtm, 1, AXIS_XYZU);  
//enables all drivers on module 1.
```

The MODBUS command is listed as follows:

TID (hex)	PID (hex)	Field Length (hex)	UID (hex)	FC (hex)	St_Addr. (hex)	Word Count (hex)	Byte Count (hex)
00 01	00 00	00 0B	01	10	1F 40	00 02	04
Register[]		Value (hex)		Remarks			
0		0A 15/0C 15		Sub_function code			
1		00 0F		axis (F → AXIS_XYZU)			

### 3.11.2 Servo Off

<b>eRET ETM_SERVO_OFF (HANDLE <i>hEtm</i>, BYTE <i>cardNo</i>, BYTE <i>axis</i>)</b>
<b>※ eRET ETM_MACRO_SERVO_OFF (HANDLE <i>hEtm</i>, BYTE <i>cardNo</i>, BYTE <i>axis</i>)</b>

**Description:**

This function outputs a DO signal to disable the motor driver.

**Category:**

MODBUS sub\_function; RTC, MP and IT.

**Parameters:**

Paramters	Description
<i>hEtm</i> :	TCP/IP connection handle
<i>cardNo</i> :	1 (ET-M8194H supports only one i-8094H module)
<i>axis</i> :	Axis or axes (Please refer to Table 3 or Table 4)  If <i>axis</i> setting is defined in Table 3, the setting values will change current settings. If <i>axis</i> setting is defined in Table 4, the setting values will be writted into the parameter table without changing current settings.

**Return:**

0: Success; Others: Fail (Please refer to chapter 2.2)

**Remark:**

The Sub\_function code of ETM\_SERVO\_OFF is 0A 16.

The Sub\_function code of ETM\_MACRO\_SERVO\_OFF is 0C 16.

**MODBUS example:**

ETM\_SERVO\_OFF (*hEtm*, 1, AXIS\_XYZU); //disables all drivers on module 1.

**The MODBUS command is listed as follows:**

TID (hex)	PID (hex)	Field Length (hex)	UID (hex)	FC (hex)	St_Addr. (hex)	Word Count (hex)	Byte Count (hex)
00 01	00 00	00 0B	01	10	1F 40	00 02	04
Register[]		Value (hex)		Remarks			
0		0A 16/0C 16		Sub_function code			
1		00 0F		axis (F → AXIS_XYZU)			

## 3.12 Servo Alarm Setting

<p><b>eRET ETM_SET_ALARM (HANDLE <i>hEtm</i>, BYTE <i>cardNo</i>, BYTE <i>axis</i>, BYTE <i>nMode</i>, BYTE <i>nAEdge</i>)</b></p> <p>※ <b>eRET ETM_MACRO_SET_ALARM (HANDLE <i>hEtm</i>, BYTE <i>cardNo</i>, BYTE <i>axis</i>, BYTE <i>nMode</i>, BYTE <i>nAEdge</i>)</b></p>
---

### Description:

This function sets the ALARM input signal related parameters.

### Category:

MODBUS sub\_function; RTC, MP and IT.

### Parameters:

Paramters	Description
<i>hEtm</i> :	TCP/IP connection handle
<i>cardNo</i> :	1 (ET-M8194H supports only one i-8094H module)
<i>axis</i> :	Axis or axes (Please refer to Table 3 or Table 4)  If <i>axis</i> setting is defined in Table 3, the setting values will change current settings.  If <i>axis</i> setting is defined in Table 4, the setting values will be writted into the parameter table without changing current settings.
<i>nMode</i> :	Mode: 0 = disable ALARM function; 1 = enable ALARM function
<i>nAEdge</i> :	Sets the trigger level 0 = low active; 1 = high active

### Return:

0: Success; Others: Fail (Please refer to chapter 2.2)

### Remark:

The Sub\_function code of ETM\_SET\_ALARM is 0A 17.  
The Sub\_function code of ETM\_MACRO\_SET\_ALARM is 0C 17.

**MODBUS example:**

```
ETM_SET_ALARM (hEtm, 1, AXIS_ZU, 1, 0);
```

```
//enable the ALARM for the Z and U axes on module 1 and set them
```

```
//as low-active.
```

The MODBUS command is listed as follows:

TID (hex)	PID (hex)	Field Length (hex)	UID (hex)	FC (hex)	St_Addr. (hex)	Word Count (hex)	Byte Count (hex)
00 01	00 00	00 0F	01	10	1F 40	00 04	08
Register[]		Value (hex)		Remarks			
0		0A 17/0C 17		<i>Sub_function code</i>			
1		00 0C		<i>axis (C → AXIS_ZU)</i>			
2		00 01		<i>nMode (1 → enable)</i>			
3		00 00		<i>nAEdge (0 → low-active)</i>			

### 3.13 Active Level Setting of In-Position Signals

```
eRET ETM_SET_INPOS (HANDLE hEtm, BYTE cardNo, BYTE axis, BYTE nMode, BYTE nEdge)

※ eRET ETM_MACRO_SET_INPOS (HANDLE hEtm, BYTE cardNo, BYTE axis, BYTE nMode, BYTE nEdge)
```

**Description:**

This function sets the INPOS input signal related parameters.

**Category:**

MODBUS sub\_function; RTC, MP and IT.

**Parameters:**

Parameters	Description
<i>hEtm:</i>	TCP/IP connection handle
<i>cardNo:</i>	1 (ET-M8194H supports only one i-8094H module)
<i>axis:</i>	Axis or axes (Please refer to Table 3 or Table 4)  If <i>axis</i> setting is defined in Table 3, the setting values will change current settings.  If <i>axis</i> setting is defined in Table 4, the setting values will be writted into the parameter table without changing current settings.
<i>nMode:</i>	Mode: 0 = disable INPOS input; 1 = enable INPOS input
<i>nEdge:</i>	Set the trigger level 0 = low active; 1 = high active

**Return:**

0: Success; Others: Fail (Please refer to chapter 2.2)

**Remark:**

The Sub\_function code of ETM\_SET\_INPOS is 0A 18.  
The Sub\_function code of ETM\_MACRO\_SET\_INPOS is 0C 18.



**MODBUS example:**

```
ETM_SET_INPOS (hEtm, 1, AXIS_X, 1, 0);
```

```
//enable the INPOS function of the X axis on module 1 and set it to
```

```
//be low-active.
```

The MODBUS command is listed as follows:

TID (hex)	PID (hex)	Field Length (hex)	UID (hex)	FC (hex)	St_Addr. (hex)	Word Count (hex)	Byte Count (hex)
00 01	00 00	00 0F	01	10	1F 40	00 04	08
Register[]		Value (hex)		Remarks			
0		0A 18/0C 18		<i>Sub_function code</i>			
1		00 01		<i>axis (1 → AXIS_X)</i>			
2		00 01		<i>nMode (1 → enable)</i>			
3		00 00		<i>nIEdge (0 → low-active)</i>			

## 3.14 Digital Filter Setting

<p><b>eRET ETM_SET_FILTER (HANDLE <i>hEtm</i>, BYTE <i>cardNo</i>, BYTE <i>axis</i>, BYTE <i>FEn</i>, BYTE <i>FLn</i>)</b></p> <p><b>※ eRET ETM_MACRO_SET_FILTER (HANDLE <i>hEtm</i>, BYTE <i>cardNo</i>, BYTE <i>axis</i>, BYTE <i>FEn</i>, BYTE <i>FLn</i>)</b></p>
---

### Description:

This function selects the axes and sets the time constant for digital filters of the input signals.

### Category:

MODBUS sub\_function; RTC, MP and IT.

### Parameters:

Paramters	Description
<i>hEtm</i> :	TCP/IP connection handle
<i>cardNo</i> :	1 (ET-M8194H supports only one i-8094H module)
<i>axis</i> :	Axis or axes (Please refer to Table 3 or Table 4)  If <i>axis</i> setting is defined in Table 3, the setting values will change current settings.  If <i>axis</i> setting is defined in Table 4, the setting values will be writted into the parameter table without changing current settings.
<i>FEn</i> :	Enabled filters. The sum of the code numbers (0~31) are used to select input signals.
<i>FLn</i> :	Sets the filter time constant (0~7).

*FEn*: Please refer to the following table.

Code Number	Enabling filters
0	Disable
1	EMG, nLMTP, nLMTM, nIN0, nIN1
2	nIN2
4	nINPOS, nALARM
8	nEXPP, nEXPM, EXPLSN
16	nIN3

**FLn:** Please refer to the following table.

Code	Removable max. noise width	Input signal delay time
0	1.75 $\mu$ SEC	2 $\mu$ SEC
1	224 $\mu$ SEC	256 $\mu$ SEC
2	448 $\mu$ SEC	512 $\mu$ SEC
3	896 $\mu$ SEC	1.024mSEC
4	1.792mSEC	2.048mSEC
5	3.584mSEC	4.096mSEC
6	7.168mSEC	8.192mSEC
7	14.336mSEC	16.384mSEC

**Return:**

0: Success; Others: Fail (Please refer to chapter 2.2)

**Remark:**

The Sub\_function code of ETM\_SET\_FILTER is 0A 19.

The Sub\_function code of ETM\_MACRO\_SET\_FILTER is 0C 19.

**MODBUS example:**

ETM\_SET\_FILTER (hEtm, 1, AXIS\_XYZU, 21, 3);

//set the filter time constants of X, Y, Z, and U axes as 1.024mSEC.

//These filters include EMG, nLMTP, nLMTM, nIN0, nIN1, nINPOS, nALARM,  
//and nIN3.

//(21 = 1+4+16) 1: EMG + nLMP + nLMPM + nIN0 + nIN1;

//4: nINPOS + nALARM;

//16: nIN3.

**Note:** The default wiring design is: nIN0 is connected to the NEAR HOME (NHOME) sensors; nIN1 is connected to the HOME sensors; and nIN2 is connected to the index of Encoder input (Z phase).

The MODBUS command is listed as follows:

TID (hex)	PID (hex)	Field Length (hex)	UID (hex)	FC (hex)	St_Addr. (hex)	Word Count (hex)	Byte Count (hex)
00 01	00 00	00 0F	01	10	1F 40	00 04	08
Register[]		Value (hex)		Remarks			
0		0A 19/0C 19		Sub_function code			
1		00 0F		axis (F → AXIS_XYZU)			
2		00 15		FEn (21 = 0x15, enable several noise filters)			
3		00 03		FLn (using filter 3)			

## 3.15 Position Counter Variable Ring Setting

### 3.15.1 Enable the Ring Counter Function

<code>eRET ETM_VRING_ENABLE (HANDLE <i>hEtm</i>, BYTE <i>cardNo</i>, BYTE <i>axis</i>, DWORD <i>nVRing</i>)</code>
<code>※ eRET ETM_MACRO_VRING_ENABLE (HANDLE <i>hEtm</i>, BYTE <i>cardNo</i>, BYTE <i>axis</i>, DWORD <i>nVRing</i>)</code>

**Description:**

This function enables the linear counter of the assigned axes as variable

**Category:**

MODBUS sub\_function; RTC, MP and IT.

**Parameters:**

Parameters	Description
<i>hEtm</i> :	TCP/IP connection handle
<i>cardNo</i> :	1 (ET-M8194H supports only one i-8094H module)
<i>axis</i> :	Axis or axes (Please refer to Table 3 or Table 4)  If <i>axis</i> setting is defined in Table 3, the setting values will change current settings.  If <i>axis</i> setting is defined in Table 4, the setting values will be writted into the parameter table without changing current settings.
<i>nVRing</i> :	Maximum value of the ring counter (0 ~ +2,000,000,000)

**Return:**

0: Success; Others: Fail (Please refer to chapter 2.2)

**Remark:**

The Sub\_function code of ETM\_VRING\_ENABLE is 0A 1A.

The Sub\_function code of ETM\_MACRO\_VRING\_ENABLE is 0C 1A.

**MODBUS example:**

```
ETM_VRING_ENABLE (hEtm, 1, AXIS_X, 9999);
```

```
//set the X axis of module 1 to be a ring counter. The encoder
```

```
//values will be 0 to 9999.
```

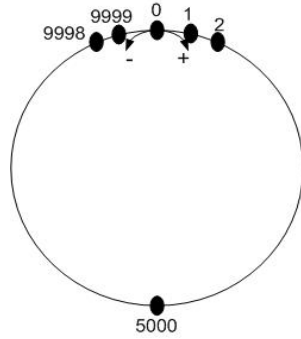

The encoder value ranges from 0 to 9999. When the counter value reaches 9999, one more adding pulse will cause the counter to reset to 0. When the counter value is 0, a lessening pulse will let the counter set to 9999.

Max. ring encoder value = 9999

- Note:**
1. This function will set the LP and EP simultaneously.
  2. If this function is enabled, the software limit function cannot be used.

The MODBUS command is listed as follows:

TID (hex)	PID (hex)	Field Length (hex)	UID (hex)	FC (hex)	St_Addr. (hex)	Word Count (hex)	Byte Count (hex)
00 01	00 00	00 0F	01	10	1F 40	00 04	08
Register[]		Value (hex)		Remarks			
0		0A 1A/0C 1A		Sub_function code			
1		00 01		axis			
2		00 00		MSW of nVRing			
3		27 0F		LSW of nVRing (9999 = 0x270F)			

### 3.15.2 Disable the Ring Counter Function

**eRET ETM\_VRING\_DISABLE (HANDLE *hEtm*, BYTE *cardNo*, BYTE *axis*)**

**※ eRET ETM\_MACRO\_VRING\_DISABLE (HANDLE *hEtm*, BYTE *cardNo*, BYTE *axis*)**

**Description:**

This function disables the variable ring counter function.

**Category:**

MODBUS sub\_function; RTC, MP and IT.

**Parameters:**

Parameters	Description
<i>hEtm</i> :	TCP/IP connection handle
<i>cardNo</i> :	1 (ET-M8194H supports only one i-8094H module)
<i>axis</i> :	Axis or axes (Please refer to Table 3 or Table 4)  If <i>axis</i> setting is defined in Table 3, the setting values will change current settings.  If <i>axis</i> setting is defined in Table 4, the setting values will be writted into the parameter table without changing current settings.

**Return:**

0: Success; Others: Fail (Please refer to chapter 2.2)

**Remark:**

The Sub\_function code of ETM\_VRING\_DISABLE is 0A 1B.

The Sub\_function code of ETM\_MACRO\_VRING\_DISABLE is 0C 1B.

**MODBUS example:**

ETM\_VRING\_DISABLE (hEtm, 1, AXIS\_X);

//disable the ring counter function for the X axis on module 1.

The MODBUS command is listed as follows:

TID (hex)	PID (hex)	Field Length (hex)	UID (hex)	FC (hex)	St_Addr. (hex)	Word Count (hex)	Byte Count (hex)
00 01	00 00	00 0B	01	10	1F 40	00 02	04
Register[]		Value (hex)		Remarks			
0		0A 1B/0C 1B		Sub_function code			
1		00 01		axis (1 → AXIS_X)			

## 3.16 Triangle Velocity Profile Prevention Setting

### 3.16.1 Enable the Triangle Prevention Function

<code>eRET ETM_AVTRI_ENABLE (HANDLE <i>hEtm</i>, BYTE <i>cardNo</i>, BYTE <i>axis</i>)</code>
<code>※ eRET ETM_MACRO_AVTRI_ENABLE (HANDLE <i>hEtm</i>, BYTE <i>cardNo</i>, BYTE <i>axis</i>)</code>

**Description:**

This function prevents a triangle form in linear acceleration (T-curve) fixed pulse driving.

**Category:**

MODBUS sub\_function; RTC, MP and IT.

**Parameters:**

Paramters	Description
<i>hEtm</i> :	TCP/IP connection handle
<i>cardNo</i> :	1 (ET-M8194H supports only one i-8094H module)
<i>axis</i> :	Axis or axes (Please refer to Table 3 or Table 4)  If <i>axis</i> setting is defined in Table 3, the setting values will change current settings.  If <i>axis</i> setting is defined in Table 4, the setting values will be writted into the parameter table without changing current settings.

**Return:**

0: Success; Others: Fail (Please refer to chapter 2.2)

**Remark:**

The Sub\_function code of ETM\_AVTRI\_ENABLE is 0A 1C.

The Sub\_function code of ETM\_MACRO\_AVTRI\_ENABLE is 0C 1C.

**MODBUS example:**

`ETM_AVTRI_ENABLE (hEtm, 1, AXIS_X);`

`//set the X axis of module 1 not to generate a triangle form in its speed profile.`



The MODBUS command is listed as follows:

TID (hex)	PID (hex)	Field Length (hex)	UID (hex)	FC (hex)	St_Addr. (hex)	Word Count (hex)	Byte Count (hex)
00 01	00 00	00 0B	01	10	1F 40	00 02	04
Register[]		Value (hex)		Remarks			
0		0A 1C/0C 1C		Sub_function code			
1		00 01		axis (1 → AXIS_X)			

### 3.16.2 Disable the Triangle Prevention Function

<p><b>eRET</b> ETM_AVTRI_DISABLE (<b>HANDLE</b> <i>hEtm</i>, <b>BYTE</b> <i>cardNo</i>, <b>BYTE</b> <i>axis</i>)</p> <p>✘ <b>eRET</b> ETM_MACRO_AVTRI_DISABLE (<b>HANDLE</b> <i>hEtm</i>, <b>BYTE</b> <i>cardNo</i>, <b>BYTE</b> <i>axis</i>)</p>
---

**Description:**

This function disables the function to prevent a triangle form in linear acceleration fixed pulse driving.

**Category:**

MODBUS sub\_function; RTC, MP and IT.

**Parameters:**

Paramters	Description
<i>hEtm</i> :	TCP/IP connection handle
<i>cardNo</i> :	1 (ET-M8194H supports only one i-8094H module)
<i>axis</i> :	Axis or axes (Please refer to Table 3 or Table 4)  If <i>axis</i> setting is defined in Table 3, the setting values will change current settings.  If <i>axis</i> setting is defined in Table 4, the setting values will be writted into the parameter table without changing current settings.

**Return:**

0: Success; Others: Fail (Please refer to chapter 2.2)

**Remark:**

The Sub\_function code of ETM\_AVTRI\_DISABLE is 0A 1D.

The Sub\_function code of ETM\_MACRO\_AVTRI\_DISABLE is 0C 1D.

**MODBUS example:**

```
ETM_AVTRI_DISABLE (hEtm, 1, AXIS_X);
//enable the X axis of module 1 to generate a triangle form in its
//speed profile if the pulse number for output is too low.
```

The MODBUS command is listed as follows:

TID (hex)	PID (hex)	Field Length (hex)	UID (hex)	FC (hex)	St_Addr. (hex)	Word Count (hex)	Byte Count (hex)
00 01	00 00	00 0B	01	10	1F 40	00 02	04
Register[]		Value (hex)		Remarks			
0		0A 1D/0C 1D		Sub_function code			
1		00 01		axis (1 → AXIS_X)			

## 3.17 External Pulse Input

### 3.17.1 Handwheel (Manual Pulse Generator) Driving

```
eRET ETM_EXD_MP (HANDLE hEtm, BYTE cardNo, BYTE axis,  
                DWORD data)
```

#### Description:

This function outputs pulses according to the input pulses from a handwheel.

#### Category:

MODBUS sub\_function; RTC.

#### Parameters:

Paramters	Description
<i>hEtm</i> :	TCP/IP connection handle
<i>cardNo</i> :	1 (ET-M8194H supports only one i-8094H module)
<i>axis</i> :	Axis or axes (Please refer to Table 3) The axis can be either X, Y, Z or U (1 or 2 or 4 or 8).
<i>data</i> :	Number of command pulses (Range: 0 ~ +2,000,000,000).

#### Return:

0: Success; Others: Fail (Please refer to chapter 2.2)

#### MODBUS example:

```
ETM_EXD_MP (hEtm, 1, AXIS_X, 1);
```

```
//Each time the handwheel inputs a pulse to the X axis  
on module 1, the controller will output 1 pulse to the motor driver.
```

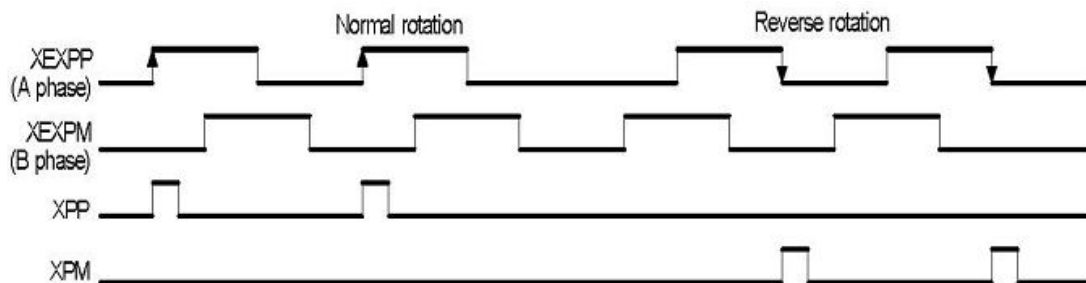

**ETM\_EXD\_MP (hEtm, 1, AXIS\_X, 2);**

**//Each time the handwheel inputs a pulse to the X axis**

**//on module 1, the controller will output 2 pulses to the motor driver.**

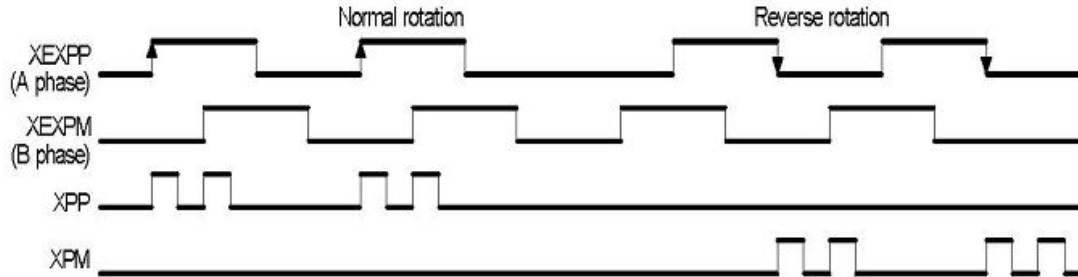

**The MODBUS command is listed as follows:**

TID (hex)	PID (hex)	Field Length (hex)	UID (hex)	FC (hex)	St_Addr. (hex)	Word Count (hex)	Byte Count (hex)
00 01	00 00	00 0F	01	10	1F 40	00 04	08
Register[]	Value (hex)	Remarks					
0	0A 1E	Sub_function code					
1	00 01	axis (1 → AXIS_X)					
2	00 00	MSW of data					
3	00 01	LSW of data					

### 3.17.2 Fixed Pulse Driving Mode

**eRET ETM\_EXD\_FP (HANDLE *hEtm*, BYTE *cardNo*, BYTE *axis*, DWORD *data*)**

**Description:**

This function outputs fixed pulses according to the trigger input (the falling edge of the nEXP+ signal) from a handwheel.

**Category:**

MODBUS sub\_function; RTC.

**Parameters:**

Paramters	Description
<i>hEtm</i> :	TCP/IP connection handle
<i>cardNo</i> :	1 (ET-M8194H supports only one i-8094H module)
<i>axis</i> :	Axis or axes (Please refer to Table 3) The axis can be either X, Y, Z or U (1 or 2 or 4 or 8).
<i>data</i> :	Number of command pulses (Range: 0 ~ +2,000,000,000).

**Return:**

0: Success; Others: Fail (Please refer to chapter 2.2)

**MODBUS example:**

ETM\_EXD\_FP (hEtm, 1, AXIS\_X, 5);

//Each time the controller detects a falling edge of an XEXP+  
//signal, it will output 5 pulses to the X axis.

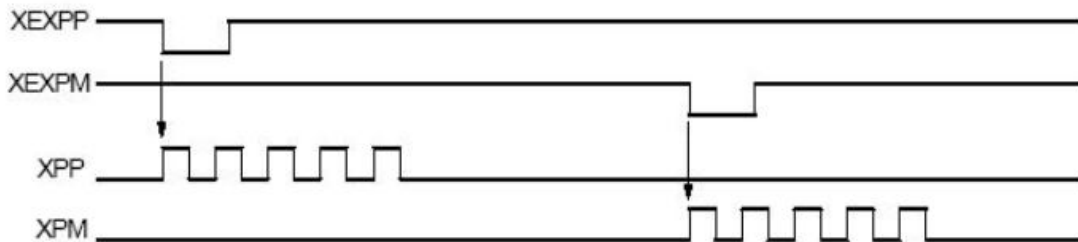

The MODBUS command is listed as follows:

TID (hex)	PID (hex)	Field Length (hex)	UID (hex)	FC (hex)	St_Addr. (hex)	Word Count (hex)	Byte Count (hex)
00 01	00 00	00 0F	01	10	1F 40	00 04	08
Register[]		Value (hex)		Remarks			
0		0A 1F		<i>Sub_function code</i>			
1		00 01		<i>axis (1 → AXIS_X)</i>			
2		00 00		<i>MSW of data</i>			
3		00 05		<i>LSW of data</i>			

### 3.17.3 Continuous Pulse Driving Mode

**eRET ETM\_EXD\_CP (HANDLE *hEtm*, BYTE *cardNo*, BYTE *axis*, DWORD *data*)**

#### Description:

The controller will continuously output pulses in positive direction if the falling edge of nEXP+ signal from a handwheel is detected. On the contrary, it will continuously output pulses in negative direction if the falling edge of nEXPsignal is detected.

#### Category:

MODBUS sub\_function; RTC.

#### Parameters:

Paramters	Description
<i>hEtm</i> :	TCP/IP connection handle
<i>cardNo</i> :	1 (ET-M8194H supports only one i-8094H module)
<i>axis</i> :	Axis or axes (Please refer to Table 3) The axis can be either X, Y, Z or U (1 or 2 or 4 or 8).
<i>data</i> :	Speed in PPS (Range: 0 ~ +2,000,000,000).

#### Return:

0: Success; Others: Fail (Please refer to chapter 2.2)

#### MODBUS example:

**ETM\_EXD\_CP (hEtm, 1, AXIS\_X, 20);**

**//Each time the controller detects a falling edge of an XEXP+ signal, it will continuously drive X axis at the speed of 20 PPS.**

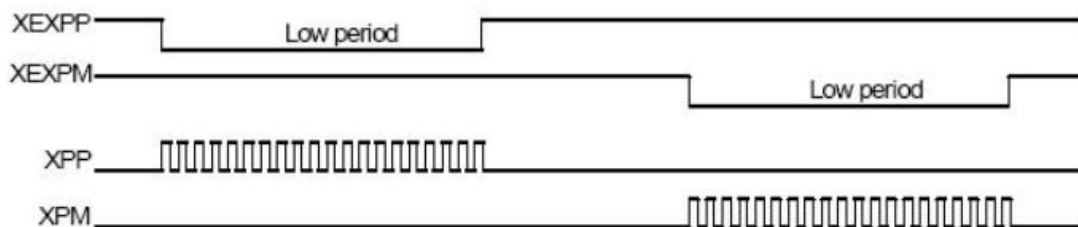



The MODBUS command is listed as follows:

TID (hex)	PID (hex)	Field Length (hex)	UID (hex)	FC (hex)	St_Addr. (hex)	Word Count (hex)	Byte Count (hex)
00 01	00 00	00 0F	01	10	1F 40	00 04	08
Register[]		Value (hex)		Remarks			
0		0A 20		<i>Sub_function code</i>			
1		00 01		<i>axis</i>			
2		00 00		<i>MSW of data</i>			
3		00 14		<i>LSW of data (20 = 0x14)</i>			

### 3.17.4 External Signal Input Setting

**eRET ETM\_EXD\_DISABLE (HANDLE *hEtm*, BYTE *cardNo*, BYTE *axis*)**

**Description:**

This function turns off the external input driving control functions.

**Category:**

MODBUS sub\_function; RTC.

**Parameters:**

Paramters	Description
<i>hEtm</i> :	TCP/IP connection handle
<i>cardNo</i> :	1 (ET-M8194H supports only one i-8094H module)
<i>axis</i> :	Axis or axes (Please refer to Table 3) The axis can be either X, Y, Z or U (1 or 2 or 4 or 8).

**Return:**

0: Success; Others: Fail (Please refer to chapter 2.2)

**MODBUS example:**

```
ETM_EXD_DISABLE (hEtm, 1, AXIS_X);
//disable the external input driving control function
of X axis on module 1
```

The MODBUS command is listed as follows:

TID (hex)	PID (hex)	Field Length (hex)	UID (hex)	FC (hex)	St_Addr. (hex)	Word Count (hex)	Byte Count (hex)
00 01	00 00	00 0B	01	10	1F 40	00 02	04
Register[]		Value (hex)		Remarks			
0		0A 21		Sub_function code			
1		00 01		axis (1 → AXIS_X)			

## 3.18 Read/Write User-Defined Variables (VAR and bVAR)

### 3.18.1 Read Byte Variable

```
eRET ETM_READ_bVAR (HANDLE hEtm, BYTE cardNo, BYTE bvarNo,
    BYTE* bVARValue)
```

#### Description:

This function read variable bVARn, it could be passed to Macro Program (MP), for detail information, please refer to Chapter 9.3.

#### Category:

MODBUS table; RTC.

#### Parameters:

Paramters	Description
<i>hEtm</i> :	TCP/IP connection handle
<i>cardNo</i> :	1 (ET-M8194H supports only one i-8094H module)
<i>bvarNo</i> :	custom variable: bVAR0 ~ bVAR127
<i>bVARValue</i> :	The pointer to the memory that stores bVARn (0 ~ +255).

#### Return:

0: Success; Others: Fail (Please refer to chapter 2.2)

#### Remark:

The corresponding holding register modbus address is as follow:

Macro Variable			
Variable Name	Address	Type	Comment
bVAR0	128	R/W	Value of bVAR0.
bVAR1	129	R/W	Value of bVAR1.
...	...		
bVAR126	254	R/W	Value of bVAR126.
bVAR127	255	R/W	Value of bVAR127.

#### MODBUS example:

Suppose the value of bVAR100 is 100, or 0x64 .  
The hexadecimal value of (128+100) is E4.

**BYTE *bVARValue*;**  
**ETM\_READ\_bVAR (hEtm, 1, bVAR100, &*bVARValue*);**  
*//read value of VAR100 in module 1*

The MODBUS command is listed as follows:

TID (hex)	PID (hex)	Field Length (hex)	UID (hex)	FC (hex)	St_Addr. (hex)	Word Count (hex)
00 01	00 00	00 06	01	03	00 E4	00 01

The response via MODBUS may be:

TID (hex)	PID (hex)	Field Length (hex)	UID (hex)	FC (hex)	Byte Count (hex)	Reg_0 Value (hex)
00 01	00 00	00 05	01	03	02	00 64

### 3.18.2 Write Byte Variable

**eRET ETM\_WRITE\_bVAR (HANDLE hEtm, BYTE cardNo, BYTE bvarNo, BYTE bVar)**

#### Description:

This function writes variable bVARn. bVARn could be passed to Macro Program (MP). For detail information, please refer to Chapter 9.3. bVAR parameter data are stored in a volatile memory.

#### Category:

MODBUS table, MODBUS sub\_function; RTC.

#### Parameters:

Paramters	Description
<i>hEtm</i> :	TCP/IP connection handle
<i>cardNo</i> :	1 (ET-M8194H supports only one i-8094H module)
<i>bvarNo</i> :	custom variable: bVAR0 ~ bVAR127
<i>bVar</i> :	Variable (0 ~ +255).

#### Return:

0: Success; Others: Fail (Please refer to chapter 2.2)

#### Remark:

The corresponding holding register modbus address is as follow:

Macro Variable			
Variable Name	Address	Type	Comment
bVAR0	128	R/W	Value of bVAR0.
bVAR1	129	R/W	Value of bVAR1.
...	...		
bVAR126	254	R/W	Value of bVAR126.
bVAR127	255	R/W	Value of bVAR127.

#### MODBUS example:

- Method 1: use Sub\_Function code method :

```
ETM_WRITE_bVAR (hEtm, 1, bVAR100, 100);
```

```
//write bVAR100=100 in module 1
```

The address of bVARn = 128 + n (or 0x80 + n).

(bVAR100 = 128 + 100 = 228 = 0xE4)

The MODBUS command is listed as follows:

TID (hex)	PID (hex)	Field Length (hex)	UID (hex)	FC (hex)	St_Addr. (hex)	Word Count (hex)	Byte Count (hex)
00 01	00 00	00 0D	01	10	1F 40	00 03	06
Register[]		Value (hex)		Remarks			
0		0A 23		Sub_function code			
1		00 E4		bvarNo = n + 0x80 = 0xE4			
2		00 64		bVar (100 = 0x64)			

■ Method 2: Set the Holding Register table :

All bVARn are defined in the holding register table. The index of bVARn is (128+n); therefore, the index, or address, of bVAR100 is 228 (= 0xE4).

The MODBUS command is listed as follows:

TID (hex)	PID (hex)	Field Length (hex)	UID (hex)	FC (hex)	St_Addr. (hex)	Word Count (hex)	Byte Count (hex)
00 01	00 00	00 09	01	10	00 E4	00 01	02
Register[]		Value (hex)		Remarks			
0		00 64		bVar (100 = 0x64)			

### 3.18.3 Read Long Variable

**eRET ETM\_READ\_VAR (HANDLE *hEtm*, BYTE *cardNo*, long *varNo*, long\* *VARValue*)**

#### Description:

This function read variable VARn, it could be passed to Macro Program (MP), for detail information, please refer to Chapter 9.3.1.

#### Category:

MODBUS table; RTC.

#### Parameters:

Paramters	Description
<i>hEtm</i> :	TCP/IP connection handle
<i>cardNo</i> :	1 (ET-M8194H supports only one i-8094H module)
<i>varNo</i> :	custom variable: VAR0 ~ VAR511
<i>&amp;VARValue</i> :	The pointer to the memory that stores VARn (-2,000,000,000 ~ +2,000,000,000).

#### Return:

0: Success; Others: Fail (Please refer to chapter 2.2)

#### MODBUS example:

All VARn are defined in the holding register table. Each VARn takes two registers space. For example, VARn takes both registers indexed by (300 + 2\*n) and (300 + 2\*n + 1). To read or write the two-register variable, the first register must be addressed first and the Length must be the multiple of 2.

The Start\_Address (index) = 300 + 2\*100 = 500 = **0x01F4**

```
long VARValue;  
ETM_READ_VAR (hEtm, 1, VAR100, &VARValue);  
//read value of VAR100 in module 1
```

The MODBUS command is listed as follows:

TID (hex)	PID (hex)	Field Length (hex)	UID (hex)	FC (hex)	St_Addr. (hex)	Word Count (hex)
00 01	00 00	00 06	01	03	01 F4	00 02

The response via MODBUS may be:

TID (hex)	PID (hex)	Field Length (hex)	UID (hex)	FC (hex)	Byte Count (hex)	Reg_0 (hex)	Reg_1 (hex)
00 01	00 00	00 07	01	03	04	00 00	27 10

To get the ldata, use the following instructions in C language.

```
ldata = Register[0];
```

```
ldata = ((ldata <<16) & 0xffff0000) | (Register[1] & 0xffff);
```



### 3.18.4 Write Long Variable

**eRET ETM\_WRITE\_VAR** (**HANDLE** *hEtm*, **BYTE** *cardNo*, **long** *varNo*, **long** *IVar*)

**Description:**

This function writes variable VARn. It could be passed to Macro Program (MP). For detail information, please refer to Chapter 9. VAR parameter data are stored in a volatile memory.

**Category:**

MODBUS table, MODBUS sub\_function; RTC.

**Parameters:**

Paramters	Description
<i>hEtm</i> :	TCP/IP connection handle
<i>cardNo</i> :	1 (ET-M8194H supports only one i-8094H module)
<i>varNo</i> :	custom variable: VAR0 ~ VAR511
<i>IVar</i> :	Value of variable (-2,000,000,000 ~ +2,000,000,000).

**Return:**

0: Success; Others: Fail (Please refer to chapter 2.2)

**MODBUS example:**

```
ETM_WRITE_VAR (hEtm, 1, VAR100, 10000);
//write VAR100=10,000 in module 1
```

■ **Method 1: use Sub\_Function code method**

The address of VARn = 0x7FFF0000 + n.

➔ the address of VAR100 = 0x7FFF0000 + 0x64 And, 10000 = 0x2710

The MODBUS command is listed as follows:

TID (hex)	PID (hex)	Field Length (hex)	UID (hex)	FC (hex)	St_Addr. (hex)	Word Count (hex)	Byte Count (hex)
00 01	00 00	00 11	01	10	1F 40	00 05	0A
Register[]		Value (hex)		Remarks			
0		0A 25		Sub_function code			
1		7F FF		MSW of varNo (MSW of 0x7FFF0064)			
2		00 64		LSW of varNo (LSW of 0x7FFF0064)			
3		00 00		MSW of IVar (MSW Of 0x2710)			
4		27 10		LSW of IVar (LSW Of 0x2710)			

■ **Method 2: Set the Holding Registers.**

All VARn are defined in the holding register table. Each VARn takes two registers space. For example, VARn takes both registers indexed by  $(300 + 2*n)$  and  $(300 + 2*n + 1)$ . To read or write the two-register variable, the first register must be addressed first and the Length must be the multiple of 2.

For VARn, the Start address =  $(300 + 2*n)$ .  
 → The Start\_Address =  $300 + 2*100 = 500 = 0x01F4$

Suppose the value of VAR100 is 10000 (= 0x2710).

The MODBUS command is listed as follows:

TID (hex)	PID (hex)	Field Length (hex)	UID (hex)	FC (hex)	St_Addr. (hex)	Word Count (hex)	Byte Count (hex)
00 01	00 00	00 0B	01	10	01 F4	00 02	04
Register[]		Value (hex)		Remarks			
0		00 00		MSW of IVar (MSW Of 0x2710)			
1		27 10		LSW of IVar (LSW Of 0x2710)			

## 3.19 Read/Write Data for Power Outage Carry-Over (MD)

### 3.19.1 Read the Machine Data

```
eRET ETM_READ_MD (HANDLE hEtm, BYTE cardNo, long mdNo,  
long* ldata, float* fdata)
```

#### Description:

This function reads the machine data. MD data are stored in a non-volatile memory.

#### Category:

MODBUS table; RTC.

#### Parameters:

Parameters	Description
<i>hEtm</i> :	TCP/IP connection handle
<i>cardNo</i> :	1 (ET-M8194H supports only one i-8094H module)
<i>mdNo</i> :	Machine data( <b>long</b> ): MD0 ~ MD1023 Machine data ( <b>float</b> ): MD1024 ~ MD2047
<i>&amp;ldata</i> :	Read MD <b>long</b> (-2,147,483,648 ~ +2,147,483,647)
<i>&amp;fdata</i> :	Read MD <b>float</b> (Integer number plus decimal number giving a total of six places).

#### Return:

0: Success; Others: Fail (Please refer to chapter 2.2)

#### MODBUS example:

All MDn are defined in the holding register table. Each MDn takes two registers space. For example, MDn takes both registers indexed by (3000 + 2\*n) and (3000 +2\*n + 1). To read or write the two-register variable, the first register must be addressed first and the Length must be the multiple of 2.

The MD100 Start\_Address = 3000 + 2\*100 = 3200 = **0x0C80**

The MD1500 Start\_Address = 3000 + 2\*1500 = 6000 = **0x1770**

```
long ldata;
```

```
float fdata;
```

```
ETM_READ_MD (hEtm, 1, MD100, &ldata, 0);
```

```
//read MD100 long data in module 1
```

```
ETM_READ_MD (hEtm, 1, MD1500, 0, &fdata);
```

**//read MD1500 float data in module 1**

**ldata: the MODBUS command is listed as follows:**

TID (hex)	PID (hex)	Field Length (hex)	UID (hex)	FC (hex)	St_Addr. (hex)	Word Count (hex)
00 01	00 00	00 06	01	03	0C 80	00 02

**ldata: The response via MODBUS may be:**

TID (hex)	PID (hex)	Field Length (hex)	UID (hex)	FC (hex)	Byte Count (hex)	Reg_0 (hex)	Reg_1 (hex)
00 01	00 00	00 07	01	03	04	12 34	56 78

**fdata: the MODBUS command is listed as follows:**

TID (hex)	PID (hex)	Field Length (hex)	UID (hex)	FC (hex)	St_Addr. (hex)	Word Count (hex)
00 01	00 00	00 06	01	03	17 70	00 02

**fdata: The response via MODBUS may be:**

TID (hex)	PID (hex)	Field Length (hex)	UID (hex)	FC (hex)	Byte Count (hex)	Reg_0 (hex)	Reg_1 (hex)
00 01	00 00	00 07	01	03	04	43 A0	D3 33

To get the ldata, use the following instructions in C language.

**ldata = Register[0];**

**ldata = ((ldata <<16) & 0xffff0000) | (Register[1] & 0xffff);**

### 3.19.2 Write the Machine Data

**eRET ETM\_WRITE\_MD (HANDLE *hEtm*, BYTE *cardNo*, long *mdNo*, long *ldata*, float *fdata*)**

**Description:**

This function writes the machine data.

**Category:**

MODBUS table, MODBUS sub\_function; RTC.

**Parameters:**

Paramters	Description
<i>hEtm</i> :	TCP/IP connection handle
<i>cardNo</i> :	1 (ET-M8194H supports only one i-8094H module)
<i>mdNo</i> :	Machine data(long): MD0 ~ MD1023 Machine data(float): MD1024 ~ MD2047
<i>ldata</i> :	Write MD long (-2,147,483,648 ~ +2,147,483,647)
<i>fdata</i> :	Write MD float (Integer number plus decimal number giving a total of six places).

**Return:**

0: Success; Others: Fail (Please refer to chapter 2.2)

**MODBUS example:**

ETM\_WRITE\_MD (hEtm, CardNo, MD100, 0x12345678, 0);  
//write MD100 long data in module 1

■ **Method 1: use Sub\_Function code method**

The address of MDn = 0x00000000 + n.

➔ The address of MD100 = 0x00000000 + 0x64

**Write MD100 = 0x12345678**

**Write MD1500 = 321.65**

ldata: the MODBUS command is listed as follows:

TID (hex)	PID (hex)	Field Length (hex)	UID (hex)	FC (hex)	St_Addr. (hex)	Word Count (hex)	Byte Count (hex)
00 01	00 00	00 15	01	10	1F 40	00 07	0E
Register[]	Value (hex)	Remarks					
0	0A 27	Sub_function code					
1	00 00	MSW of mdNo (= 0)					
2	00 64	LSW of mdNo (n= 0x64)					
3	12 34	MSW of ldata					
4	56 78	LSW of ldata					
5	00 00	MSW of fdata					
6	00 00	LSW of fdata					

fdata: the MODBUS command is listed as follows:

TID (hex)	PID (hex)	Field Length (hex)	UID (hex)	FC (hex)	St_Addr. (hex)	Word Count (hex)	Byte Count (hex)
00 01	00 00	00 15	01	10	1F 40	00 07	0E
Register[]	Value (hex)	Remarks					
0	0A 27	Sub_function code					
1	00 00	MSW of mdNo (= 0)					
2	05 DC	LSW of mdNo (n= 0x05DC)					
3	00 00	MSW of ldata					
4	00 00	LSW of ldata					
5	43 A0	MSW of fdata					
6	D3 33	LSW of fdata					

■ Method 2: Set the Holding Registers.

All MDn are defined in the holding register table. Each MDn takes two registers space. For example, MDn takes both registers indexed by (3000 + 2\*n) and (3000 +2\*n + 1). To read or write the two-register variable, the first register must be addressed first and the Length must be the multiple of 2.

→The Start\_Address = 3000 + 2\*100 = 3200 = 0x0C80

ldata: the MODBUS command is listed as follows:

TID (hex)	PID (hex)	Field Length (hex)	UID (hex)	FC (hex)	St_Addr. (hex)	Word Count (hex)	Byte Count (hex)
00 01	00 00	00 0B	01	10	0C 80	00 02	04
Register[]	Value (hex)	Remarks					
0	12 34	MSW of MD100					
1	56 78	LSW of MD100					

→The Start\_Address = 3000 + 2\*1500 = 6000 = **0x1770**

ldata: the MODBUS command is listed as follows:

TID (hex)	PID (hex)	Field Length (hex)	UID (hex)	FC (hex)	St_Addr. (hex)	Word Count (hex)	Byte Count (hex)
00 01	00 00	00 0B	01	10	17 70	00 02	04
Register[]		Value (hex)		Remarks			
0		43 A0		MSW of <b>MD1500</b>			
1		D3 33		LSW of <b>MD1500</b>			

---

## 4 Motion Controller Status

---

### 4.1 Set and Read Commanded Position

#### 4.1.1 Set the Logical Position Counter

```
eRET ETM_SET_LP (HANDLE hEtm, BYTE cardNo, BYTE axis, long  
wdata)
```

```
※Δ eRET ETM_MACRO_SET_LP (HANDLE hEtm, BYTE cardNo, BYTE axis,  
long wdata)
```

**Description:**

This function sets the command position counter value (logical position counter, LP).

**Category:**

MODBUS table, MODBUS sub\_function; RTC, MP and ISR.

**Parameters:**

Paramters	Description
<i>hEtm:</i>	TCP/IP connection handle
<i>cardNo:</i>	1 (ET-M8194H supports only one i-8094H module)
<i>axis:</i>	Axis or axes (Please refer to Table 3) The axis can be either X, Y, Z or U (1 or 2 or 4 or 8)
<i>wdata:</i>	Position command (-2,000,000,000 ~ +2,000,000,000)

**Return:**

0: Success; Others: Fail (Please refer to chapter 2.2)

**Remark:**

The Sub\_function code of ETM\_SET\_LP is 0A 28.

The Sub\_function code of ETM\_MACRO\_SET\_LP is 0C 28.

**MODBUS example:**

```
ETM_SET_LP (hEtm, 1, AXIS_XYZU, 10000);
```

```
//Set the LP to 10000 for X, Y, Z, and U axes in module 1
```

```
// will clear all LP counters on module 1
```



■ Method 1: use sub\_function code method

The MODBUS command is listed as follows:

TID (hex)	PID (hex)	Field Length (hex)	UID (hex)	FC (hex)	St_Addr. (hex)	Word Count (hex)	Byte Count (hex)
00 01	00 00	00 0F	01	10	1F 40	00 04	08
Register[]		Value (hex)		Remarks			
0		0A 28/0C 28		Sub_function code			
1		00 0F		axis (F → <a href="#">AXIS_XYZU</a> )			
2		00 00		MSW of wdata			
3		27 10		LSW of wdata			

■ Method 2: Set the holding registers.

The Start address is 90, or 0x5A, for LP\_X. Since the LP needs 2 registers to hold the value, the start address setting for MODBUS request must begin from the MSW of the required LP. Otherwise, the host will receive an exception error. This rule will be applied to other long, DWORD or float type values.

Method 2 allows users to set different values for 4 different axes at only one MODBUS request, which is not possible by using method 1.

The MODBUS command is listed as follows:

TID (hex)	PID (hex)	Field Length (hex)	UID (hex)	FC (hex)	St_Addr. (hex)	Word Count (hex)	Byte Count (hex)
00 01	00 00	00 17	01	10	00 5A	00 08	10
Register[]		Value (hex)		Remarks			
0		00 00		LP_X_MSW (address = 0x5A)			
1		27 10		LP_X_LSW			
2		00 00		LP_Y_MSW (address = 0x5C)			
3		27 10		LP_Y_LSW			
4		00 00		LP_Z_MSW (address = 0x5E)			
5		27 10		LP_Z_LSW			
6		00 00		LP_U_MSW (address = 0x60)			
7		27 10		LP_U_LSW			

## 4.1.2 Read the Logical Position Counter

**eRET ETM\_GET\_LP(HANDLE *hEtm*, BYTE *cardNo*, BYTE *axis*, long\* *LPValue*)**

**※Δ eRET ETM\_MACRO\_GET\_LP (HANDLE *hEtm*, BYTE *cardNo*, BYTE *axis*)**

**eRET ETM\_GET\_LP\_4\_AXIS(HANDLE *hEtm*, BYTE *cardNo*, long\* *LpValueX*, long\* *LpValueY*, long\* *LpValueZ*, long\* *LpValueU*)**

### Description:

This function reads the command position counter value (logical position counter, LP).

### Category:

MODBUS table, MODBUS sub\_function; RTC, MP and ISR.

### Parameters:

Paramters	Description
<i>hEtm</i> :	TCP/IP connection handle
<i>cardNo</i> :	1 (ET-M8194H supports only one i-8094H module)
<i>axis</i> :	Axis or axes (Please refer to Table 3) The axis can be either X, Y, Z or U (1 or 2 or 4 or 8)
<i>LPValue</i> :	The pointer to the memory that stores the logical position counter (-2,000,000,000 ~+2,000,000,000).
<i>LpValueX</i> :	The pointer to the memory that stores the logical position counter (-2,000,000,000 ~+2,000,000,000) of x axis.
<i>LpValueY</i> :	The pointer to the memory that stores the logical position counter (-2,000,000,000 ~+2,000,000,000) of y axis.
<i>LpValueZ</i> :	The pointer to the memory that stores the logical position counter (-2,000,000,000 ~+2,000,000,000) of z axis.
<i>LpValueU</i> :	The pointer to the memory that stores the logical position counter (-2,000,000,000 ~+2,000,000,000) of u axis.

### Return:

0: Success; Others: Fail (Please refer to chapter 2.2)

## MODBUS example:

- Method 1: Use Holding Registers to get the current values.

Since each LP needs 2 registers to hold the value, the start address setting for MODBUS request must begins from the MSW of the required LP. Otherwise, the host will receive an exception error. This rule will be applied to other long, DWORD or float type values.

This method allows users to get more than one axis data at only one MODBUS request. Please refer to MODBUS holding registers definition table.

```
long X_LP;  
ETM_GET_LP (hEtm, 1, AXIS_X, &X_LP);  
//Reads the LP value of the X axis on module 1.
```

The MODBUS command is listed as follows:

TID (hex)	PID (hex)	Field Length (hex)	UID (hex)	FC (hex)	St_Addr. (hex)	Word Count (hex)
00 01	00 00	00 06	01	03	00 5A	00 02

The response via MODBUS may be:

TID (hex)	PID (hex)	Field Length (hex)	UID (hex)	FC (hex)	Byte Count (hex)	Reg_0 (hex)	Reg_1 (hex)
00 01	00 00	00 07	01	03	04	00 00	27 10

To get the X\_LP, use the following instructions in C language.

```
X_LP = Register[0];  
X_LP = ((X_LP <<16) & 0xffff0000) | (Register[1] & 0xffff);
```

- Method 2: It is used as an MP instruction.

For this case, the current LP value does not actually be returned at the moment when request is sent. The getting LP instruction is desired to be executed later when an MP is called. Users can use FC = 16 to write this command into an MP. Inside this MP, there can be an ETM\_MACRO\_SET\_RVAR() function just next to it to save the return LP value to a specified variable. This variable can be referred by other functions. Please refer to other related MP usages explanations.

```
ETM_MACRO_GET_LP (hEtm, 1, AXIS_X);  
//Reads the LP value of the X axis on module 1.
```

The MODBUS command is listed as follows:

TID (hex)	PID (hex)	Field Length (hex)	UID (hex)	FC (hex)	St_Addr. (hex)	Word Count (hex)	Byte Count (hex)
00 01	00 00	00 0B	01	10	1F 40	00 02	04
Register[]		Value (hex)		Remarks			
0		0C 29		Sub_function code			
1		00 01		axis (1 → AXIS_X)			

## 4.2 Set and Read the Encoder Counter

### 4.2.1 Set the Encoder Position Counter

```
eRET ETM_SET_EP (HANDLE hEtm, BYTE cardNo, BYTE axis, long  
wdata)
```

```
※Δ eRET ETM_MACRO_SET_EP (HANDLE hEtm, BYTE cardNo, BYTE axis,  
long wdata)
```

#### Description:

This function sets the encoder position counter value (real position counter or EP).

#### Category:

MODBUS table, MODBUS sub\_function; RTC, MP and ISR.

#### Parameters:

Parameters	Description
<i>hEtm</i> :	TCP/IP connection handle
<i>cardNo</i> :	1 (ET-M8194H supports only one i-8094H module)
<i>axis</i> :	Axis or axes (Please refer to Table 3) The axis can be either X, Y, Z or U (1 or 2 or 4 or 8)
<i>wdata</i> :	Position command (-2,000,000,000 ~ +2,000,000,000)

#### Return:

0: Success; Others: Fail (Please refer to chapter 2.2)

#### Remark:

The Sub\_function code of ETM\_SET\_EP is 0A 2A.

The Sub\_function code of ETM\_MACRO\_SET\_EP is 0C 2A.

#### MODBUS example:

```
ETM_SET_EP (hEtm, 1, AXIS_XYZU, 10000);
```

```
//Set the EP as 10000 for X, Y, Z, and U axes of module 1.
```

■ Method 1: use Sub\_Function code method

The MODBUS command is listed as follows:

TID (hex)	PID (hex)	Field Length (hex)	UID (hex)	FC (hex)	St_Addr. (hex)	Word Count (hex)	Byte Count (hex)
00 01	00 00	00 0F	01	10	1F 40	00 04	08
Register[]		Value (hex)		Remarks			
0		0A 2A/0C 2A		Sub_function code			
1		00 0F		axis (F → <a href="#">AXIS_XYZU</a> )			
2		00 00		MSW of wdata			
3		27 10		LSW of wdata			

■ Method 2: Set the Holding Registers.

Since each EP needs 2 registers to hold the value, the start address setting for MODBUS request must begin from the MSW of the required EP. Otherwise, the host will receive an exception error. This rule will be applied to other long, DWORD or float type values.

This method allows users to set more than one axis data at only one MODBUS request. Please refer to MODBUS holding registers definition table.

The start address is 98, or 0x62, for EP\_X.

The MODBUS command is listed as follows:

TID (hex)	PID (hex)	Field Length (hex)	UID (hex)	FC (hex)	St_Addr. (hex)	Word Count (hex)	Byte Count (hex)
00 01	00 00	00 17	01	10	00 62	00 08	10
Register[]		Value (hex)		Remarks			
0		00 00		LP_X_MSW (address = 0x5A)			
1		27 10		LP_X_LSW			
2		00 00		LP_Y_MSW (address = 0x5C)			
3		27 10		LP_Y_LSW			
4		00 00		LP_Z_MSW (address = 0x5E)			
5		27 10		LP_Z_LSW			
6		00 00		LP_U_MSW (address = 0x60)			
7		27 10		LP_U_LSW			

## 4.2.2 Read the Encoder Position Counter

**eRET ETM\_GET\_EP (HANDLE hEtm, BYTE cardNo, BYTE axis , long\* EPValue)**

**※Δ eRET ETM\_MACRO\_GET\_EP (HANDLE hEtm, BYTE cardNo, BYTE axis)**

**eRET ETM\_GET\_EP\_4\_AXIS (HANDLE hEtm, BYTE cardNo, long\* EpValueX, long\* EpValueY, long\* EpValueZ, long\* EpValueU)**

### Description:

This function reads the encoder position counter value (EP).

### Category:

MODBUS table, MODBUS sub\_function; RTC, MP and ISR.

### Parameters:

Paramters	Description
<b>hEtm:</b>	TCP/IP connection handle
<b>cardNo:</b>	1 (ET-M8194H supports only one i-8094H module)
<b>axis:</b>	Axis or axes (Please refer to Table 3) The axis can be either X, Y, Z or U (1 or 2 or 4 or 8)
<b>EPValue:</b>	The pointer to the memory that stores the encoder position counter (-2,000,000,000 ~ +2,000,000,000).
<b>EpValueX:</b>	The pointer to the memory that stores the encoder position counter (-2,000,000,000 ~+2,000,000,000) of x axis.
<b>EpValueY:</b>	The pointer to the memory that stores the encoder position counter (-2,000,000,000 ~+2,000,000,000) of y axis.
<b>EpValueZ:</b>	The pointer to the memory that stores the encoder position counter (-2,000,000,000 ~+2,000,000,000) of z axis.
<b>EpValueU:</b>	The pointer to the memory that stores the encoder position counter (-2,000,000,000 ~+2,000,000,000) of u axis.

### Return:

0: Success; Others: Fail (Please refer to chapter 2.2)

## MODBUS example:

Suppose the EP is 10000, or 0x2710. The Start address is 98, or 0x62. Since the EP needs 2 registers to hold the value, the start address setting for MODBUS request must begin from the MSW of the required EP. Otherwise, the host will receive an exception error. This rule will be applied to other long, DWORD or float type values.

- Method 1: Use holding registers to get the current values.

```
long X_EP;  
ETM_GET_EP (hEtm, 1, AXIS_X, &X_EP);  
//reads the encoder position value (EP) of the X axis on module 1.
```

The MODBUS command is listed as follows:

TID (hex)	PID (hex)	Field Length (hex)	UID (hex)	FC (hex)	St_Addr. (hex)	Word Count (hex)
00 01	00 00	00 06	01	03	00 62	00 02

The response via MODBUS may be:

TID (hex)	PID (hex)	Field Length (hex)	UID (hex)	FC (hex)	Byte Count (hex)	Reg_0 (hex)	Reg_1 (hex)
00 01	00 00	00 07	01	03	04	00 00	27 10

To get the X\_EP, use the following instructions in C language.  
X\_EP = Register[0];  
X\_EP = ((X\_EP <<16) & 0xffff0000) | (Register[1] & 0xffff);

- Method 2: It is used for creating the content of an MP.

For this case, users do not actually want to get the current EP values. The getting EP will be executed only when the MP is called. Therefore, use **FC = 16** to write this command inside a MP. This kind of usages often has **ETM\_MACRO\_SET\_RVAR()** followed to get the return EP value. Please refer to MP related explanation literature.

```
ETM_MACRO_GET_EP (hEtm, 1, AXIS_X);
```



The MODBUS command is listed as follows:

TID (hex)	PID (hex)	Field Length (hex)	UID (hex)	FC (hex)	St_Addr. (hex)	Word Count (hex)	Byte Count (hex)
00 01	00 00	00 0B	01	10	1F 40	00 02	04
Register[]		Value (hex)		Remarks			
0		0C 2B		Sub_function code			
1		00 01		axis (1 → AXIS_X)			

## 4.3 Set and Read Absolute Position

### 4.3.1 Set the Absolute Position Counter

```
eRET ETM_ABS_SET_POSITION (HANDLE hEtm, BYTE cardNo, BYTE axis, long wdata)
```

```
※Δ eRET ETM_MACRO_ABS_SET_POSITION (HANDLE hEtm, BYTE cardNo, BYTE axis, long wdata)
```

#### Description:

This function assigns the current position to a new logic position value. The new value will be regarded as the new reference position for the absolute position reading and writing.

#### Category:

MODBUS table, MODBUS sub\_function; RTC, MP and ISR.

#### Parameters:

Paramters	Description
<i>hEtm</i> :	TCP/IP connection handle
<i>cardNo</i> :	1 (ET-M8194H supports only one i-8094H module)
<i>axis</i> :	Axis or axes (Please refer to Table 3) The axis can be either X, Y, Z or U (1 or 2 or 4 or 8)
<i>wdata</i> :	Absolute Position value (-2,000,000,000 ~ +2,000,000,000)

#### Return:

0: Success; Others: Fail (Please refer to chapter 2.2)

#### Remark:

The Sub\_function code of ETM\_ABS\_SET\_POSITION is 0x0AF4.  
The Sub\_function code of ETM\_MACRO\_ABS\_SET\_POSITION is 0x0CF4.

#### MODBUS example:

```
ETM_ABS_SET_POSITION (hEtm, 1, AXIS_X, 40000);  
//Set the current absolute position of x-axis to 40000
```

■ Method 1: use sub\_function code method

The MODBUS command is listed as follows:

TID (hex)	PID (hex)	Field Length (hex)	UID (hex)	FC (hex)	St_Addr. (hex)	Word Count (hex)	Byte Count (hex)
00 01	00 00	00 0F	01	10	1F 40	00 04	08
Register[]		Value (hex)		Remarks			
0		0A F4/0C F4		Sub_function code			
1		00 0F		axis (F → <b>AXIS_XYZU</b> )			
2		00 00		MSW of wdata			
3		9C 40		LSW of wdata			

■ Method 2: Set the holding registers.

The Start address is 82, or 0x52, for the absolute position of the x-axis. Since the absolute position needs 2 registers to hold the value, the start address setting for MODBUS request must begin from the MSW of the required absolute position. Otherwise, the host will receive an exception error. This rule will be applied to other long, DWORD or float type values.

Method 2 allows users to set different values for 4 different axes at only one MODBUS request, which is not possible by using method 1.

The MODBUS command is listed as follows:

TID (hex)	PID (hex)	Field Length (hex)	UID (hex)	FC (hex)	St_Addr. (hex)	Word Count (hex)	Byte Count (hex)
00 01	00 00	00 17	01	10	00 52	00 08	10
Register[]		Value (hex)		Remarks			
0		00 00		Absolute LP_X_MSW (address = 0x52)			
1		27 10		Absolute LP_X_LSW			
2		00 00		Absolute LP_Y_MSW (address = 0x54)			
3		27 10		Absolute LP_Y_LSW			
4		00 00		Absolute LP_Z_MSW (address = 0x56)			
5		27 10		Absolute LP_Z_LSW			
6		00 00		Absolute LP_U_MSW (address = 0x58)			
7		27 10		Absolute LP_U_LSW			

### 4.3.2 Read the Absolute Position Counter

**eRET ETM\_ABS\_GET\_POSITION (HANDLE *hEtm*, BYTE *cardNo*, BYTE *axis*, long\* *LPAbsValue*)**

**※Δ eRET ETM\_MACRO\_ABS\_GET\_POSITION (HANDLE *hEtm*, BYTE *cardNo*, BYTE *axis*)**

**eRET ETM\_ABS\_GET\_POSITION\_4\_AXIS (HANDLE *hEtm*, BYTE *cardNo*, long\* *LpAbsValueX*, long\* *LpAbsValueY*, long\* *LpAbsValueZ*, long\* *LpAbsValueU*)**

**Description:**

This function reads the current absolute logic position (logical position counter).

**Category:**

MODBUS table, MODBUS sub\_function; RTC, MP and ISR.

**Parameters:**

Paramters	Description
<i>hEtm</i> :	TCP/IP connection handle
<i>cardNo</i> :	1 (ET-M8194H supports only one i-8094H module)
<i>axis</i> :	Axis or axes (Please refer to Table 3) The axis can be either X, Y, Z or U (1 or 2 or 4 or 8)
<i>LPAbsValue</i> :	The pointer to the memory that stores the logical position counter (-2,000,000,000 ~+2,000,000,000).
<i>LpAbsValueX</i> :	The pointer to the memory that stores the logical position counter (-2,000,000,000 ~+2,000,000,000) of x axis.
<i>LpAbsValueY</i> :	The pointer to the memory that stores the logical position counter (-2,000,000,000 ~+2,000,000,000) of y axis.
<i>LpAbsValueZ</i> :	The pointer to the memory that stores the logical position counter (-2,000,000,000 ~+2,000,000,000) of z axis.
<i>LpAbsValueU</i> :	The pointer to the memory that stores the logical position counter (-2,000,000,000 ~+2,000,000,000) of u axis.

**Return:**

0: Success; Others: Fail (Please refer to chapter 2.2)

## MODBUS example:

- Method 1: Use Holding Registers to get the current values.

Since each absolute LP needs 2 registers to hold the value, the start address setting for MODBUS request must begin from the MSW of the required LP. Otherwise, the host will receive an exception error. This rule will be applied to other long, DWORD or float type values.

This method allows users to get more than one axis data at only one MODBUS request. Please refer to MODBUS holding registers definition table.

```
long X_AbsLP;  
ETM_ABS_GET_POSITION (hEtm, 1, AXIS_X, &X_AbsLP);  
//Reads the current absolute position LP value of the X axis.
```

The MODBUS command is listed as follows:

TID (hex)	PID (hex)	Field Length (hex)	UID (hex)	FC (hex)	St_Addr. (hex)	Word Count (hex)
00 01	00 00	00 06	01	03	00 52	00 02

The response via MODBUS may be:

TID (hex)	PID (hex)	Field Length (hex)	UID (hex)	FC (hex)	Byte Count (hex)	Reg_0 (hex)	Reg_1 (hex)
00 01	00 00	00 07	01	03	04	00 00	27 10

To get the X\_AbsLP, use the following instructions in C language.

```
X_AbsLP = Register[0];  
X_AbsLP = ((X_AbsLP <<16) & 0xffff0000) | (Register[1] & 0xffff);
```

- Method 2: It is used as an MP instruction.

For this case, the current LP value does not actually be returned at the moment when request is sent. The getting LP instruction is desired to be executed later when an MP is called. Users can use **FC = 16** to write this command into an MP. Inside this MP, there can be an **ETM\_MACRO\_SET\_RVAR()** function just next to it to save the return LP value to a specified variable. This variable can be referred by other functions. Please refer to other related MP usages explanations.

```
ETM_MACRO_ABS_GET_POSITION (hEtm, 1, AXIS_X);  
//Reads the LP value of the X axis on module 1.
```

The MODBUS command is listed as follows:

TID (hex)	PID (hex)	Field Length (hex)	UID (hex)	FC (hex)	St_Addr. (hex)	Word Count (hex)	Byte Count (hex)
00 01	00 00	00 0B	01	10	1F 40	00 02	04
Register[]		Value (hex)		Remarks			
0		0C F5		Sub_function code			
1		00 01		axis (1 → AXIS_X)			

## 4.4 Get Current Velocity

```
eRET ETM_GET_CV (HANDLE hEtm, BYTE cardNo, BYTE axis, long* CVValue)
```

```
eRET ETM_GET_CV_4_AXIS (HANDLE hEtm, BYTE cardNo, long* CvValueX, long* CvValueY, long* CvValueZ, long* CvValueU)
```

### Description:

This function reads the current velocity value.

### Category:

MODBUS table; RTC.

### Parameters:

Parameters	Description
<i>hEtm</i> :	TCP/IP connection handle
<i>cardNo</i> :	1 (ET-M8194H supports only one i-8094H module)
<i>axis</i> :	Axis or axes (Please refer to Table 3) The axis can be either X, Y, Z or U (1 or 2 or 4 or 8)
<i>CVValue</i> :	The pointer to the memory that stores the current velocity
<i>CvValueX</i> :	The pointer to the memory that stores the current velocity of x axis
<i>CvValueY</i> :	The pointer to the memory that stores the current velocity of y axis
<i>CvValueZ</i> :	The pointer to the memory that stores the current velocity of z axis
<i>CvValueU</i> :	The pointer to the memory that stores the current velocity of u axis

### Return:

0: Success; Others: Fail (Please refer to chapter 2.2)

### MODBUS example:

Suppose the CV is 10000, or 0x2710. The Start address is 106, or 0x6A.

```
long CVValue;  
ETM_GET_CV (hEtm, 1, AXIS_X, &CVValue);  
//reads the current velocity of the X axis on module 1
```

The MODBUS command is listed as follows:

TID (hex)	PID (hex)	Field Length (hex)	UID (hex)	FC (hex)	St_Addr. (hex)	Word Count (hex)
00 01	00 00	00 06	01	03	00 6A	00 02

The response via MODBUS may be:

TID (hex)	PID (hex)	Field Length (hex)	UID (hex)	FC (hex)	Byte Count (hex)	Reg_0 (hex)	Reg_1 (hex)
00 01	00 00	00 07	01	03	04	00 00	27 10

To get the CV\_X, use the following instructions in C language.

```
CV_X = Register[0];
```

```
CV_X = ((CV_X <<16) & 0xffff0000) | (Register[1] & 0xffff);
```



## 4.5 Get Current Acceleration

```
eRET ETM_GET_CA (HANDLE hEtm, BYTE cardNo, BYTE axis , long* CAValue)
```

```
eRET ETM_GET_CA_4_AXIS (HANDLE hEtm, BYTE cardNo, long* CaValueX, long* CaValueY, long* CaValueZ, long* CaValueU)
```

### Description:

This function reads the current acceleration value PPS/sec.

### Category:

MODBUS table; RTC.

### Parameters:

Paramters	Description
<i>hEtm</i> :	TCP/IP connection handle
<i>cardNo</i> :	1 (ET-M8194H supports only one i-8094H module)
<i>axis</i> :	Axis or axes (Please refer to Table 3) The axis can be either X, Y, Z or U (1 or 2 or 4 or 8)
<i>CAValue</i> :	The pointer to the memory that stores the current acceleration (in PPS/Sec).
<i>CaValueX</i> :	The pointer to the memory that stores the current acceleration (in PPS/Sec) of x axis.
<i>CaValueY</i> :	The pointer to the memory that stores the current acceleration (in PPS/Sec) of y axis.
<i>CaValueZ</i> :	The pointer to the memory that stores the current acceleration (in PPS/Sec) of z axis.
<i>CaValueU</i> :	The pointer to the memory that stores the current acceleration (in PPS/Sec) of u axis.

### Return:

0: Success; Others: Fail (Please refer to chapter 2.2)

### MODBUS example:

Suppose the CA is 10000, or 0x2710. The Start address is 114, or 0x72.

```
long CAValue;  
ETM_GET_CA (hEtm, 1, AXIS_X, &CAValue);  
//reads the current acceleration value of the X axis on module 1.
```

The MODBUS command is listed as follows:

TID (hex)	PID (hex)	Field Length (hex)	UID (hex)	FC (hex)	St_Addr. (hex)	Word Count (hex)
00 01	00 00	00 06	01	03	00 72	00 02

The response via MODBUS may be:

TID (hex)	PID (hex)	Field Length (hex)	UID (hex)	FC (hex)	Byte Count (hex)	Reg_0 (hex)	Reg_1 (hex)
00 01	00 00	00 07	01	03	04	00 00	27 10

To get the CA\_X, use the following instructions in C language.

```
CA_X = Register[0];
```

```
CA_X = ((CA_X <<16) & 0xffff0000) | (Register[1] & 0xffff);
```

## 4.6 Get DI Triggered Motion Status

### 4.6.1 Get Single DI Triggered Motion Status

※Δ eRET ETM\_MACRO\_GET\_DI (HANDLE *hEtm*, BYTE *cardNo*, BYTE *axis*, BYTE *nType*)

#### Description:

This function reads the motion chip status triggered by the digital input (DI) signal.

#### Category:

MODBUS sub\_function; MP, ISR.

#### Parameters:

Paramters	Description
<i>hEtm</i> :	TCP/IP connection handle
<i>cardNo</i> :	1 (ET-M8194H supports only one i-8094H module)
<i>axis</i> :	Axis or axes (Please refer to Table 3) The axis can be either X, Y, Z or U (1 or 2 or 4 or 8)
<i>nType</i> :	0 → DRIVING (Check whether the axis is driving or not) 1 → LIMIT+ (Check whether the limit+ is engaged or not) 2 → LIMIT- (Check whether the limit- is engaged or not) 3 → EMERGENCY (Check whether EMG signal is on or not) 4 → ALARM (Check the ALARM input signal) 5 → IN1 (Check the IN1 input signal) 6 → IN0 (Check the IN0 input signal) 7 → IN3 (Check the IN3 input signal) 8 → INPOS (Check the INPOS input signal) 9 → IN2 (Check the IN2 input signal)

#### Return:

0: Success; Others: Fail (Please refer to chapter 2.2)

#### MODBUS example:

- It is used for creating the content of an MP.

For this case, users do not actually want to get the current DI values. The getting DI will be executed only when the MP is called. Therefore, use **FC = 16** to write this command inside a MP. This kind of usage often has

**ETM\_MACRO\_SET\_RVAR()** followed to get the return DI value. Please refer to MP related explanation literature.

**ETM\_MACRO\_GET\_DI** (hEtm, 1, AXIS\_X, 1);

The MODBUS command is listed as follows:

TID (hex)	PID (hex)	Field Length (hex)	UID (hex)	FC (hex)	St_Addr. (hex)	Word Count (hex)	Byte Count (hex)
00 01	00 00	00 0D	01	10	1F 40	00 03	06
Register[]		Value (hex)		Remarks			
0		0C 2E		<i>Sub_function code</i>			
1		00 01		<i>axis</i>			
2		00 01		<i>The specified DI (LIMIT+)</i>			

## 4.6.2 Get All DI Triggered Motion Status

**eRET ETM\_GET\_DI\_ALL (HANDLE *hEtm*, BYTE *cardNo*, BYTE *axis* , WORD\* *DValue*)**

**※Δ eRET ETM\_MACRO\_GET\_DI\_ALL (HANDLE *hEtm*, BYTE *cardNo*, BYTE *axis*)**

**eRET ETM\_GET\_DI\_ALL\_4\_AXIS (HANDLE *hEtm*, BYTE *cardNo*, WORD\* *DiValueX*, WORD\* *DiValueY*, WORD\* *DiValueZ*, WORD\* *DiValueU*)**

### Description:

These function reads the motion chip status triggered by the digital input (DI) signal.

### Category:

MODBUS table, MODBUS sub\_function; RTC, MP and ISR.

### Parameters:

Paramters	Description
<i>hEtm</i> :	TCP/IP connection handle
<i>cardNo</i> :	1 (ET-M8194H supports only one i-8094H module)
<i>axis</i> :	Axis or axes (Please refer to Table 3) The axis can be either X, Y, Z or U (1 or 2 or 4 or 8)
<i>DValue</i> :	The pointer to the memory that stores the all DI Status The bits in <i>DValue</i> are defined as follows: <i>Bit 0</i> → DRIVING (Axis is driving or not) <i>Bit 1</i> → LIMIT+ (Limit+ is engaged or not) <i>Bit 2</i> → LIMIT- (Limit- is engaged or not) <i>Bit 3</i> → EMERGENCY (EMG signal) <i>Bit 4</i> → ALARM (ALARM signal) <i>Bit 5</i> → IN1 (IN1 input signal, low-active) <i>Bit 6</i> → IN0 (IN0 input signal, low-active) <i>Bit 7</i> → IN3 (IN3 input signal, low-active) <i>Bit 8</i> → INPOS (INPOS input signal) <i>Bit 9</i> → IN2 (IN2 input signal, low-active)
<i>DiValueX</i> :	The pointer to the memory that stores the all DI Status of x axis
<i>DiValueY</i> :	The pointer to the memory that stores the all DI Status of y axis
<i>DiValueZ</i> :	The pointer to the memory that stores the all DI Status of z axis
<i>DiValueU</i> :	The pointer to the memory that stores the all DI Status of u axis

Return:

0: Success; Others: Fail (Please refer to chapter 2.2)

MODBUS example:

- Method 1: It is used for getting current status of DI.

Each bit corresponds to a register. Each register's value is either 0 or 1.

WORD DIValue;

**ETM\_GET\_DI\_ALL** (hEtm, 1, AXIS\_X, &DIValue);

The MODBUS command is listed as follows:

TID (hex)	PID (hex)	Field Length (hex)	UID (hex)	FC (hex)	St_Addr. (hex)	Word Count (hex)
00 01	00 00	00 06	01	04	00 10	00 01

The response via MODBUS may be:

TID (hex)	PID (hex)	Field Length (hex)	UID (hex)	FC (hex)	Byte Count (hex)	DI Status of AXIS_X. ( Reg_0 )
00 01	00 00	00 05	01	04	02	00 00

- Method 2: When it is used inside an MP.

For this case, users do not actually want to get the current DI values. The getting DI will be executed only when the MP is called. Therefore, use **FC = 16** to write this command inside a MP. This kind of usage often has **ETM\_MACRO\_SET\_RVAR()** followed to get the return DI value. Please refer to MP-related explanation literature.

**ETM\_MACRO\_GET\_DI\_ALL** (hEtm, 1, AXIS\_X);

//ETM\_MACRO\_SET\_RVAR(hEtm, 1, VAR0); //assign this DI value to  
//VAR0

The MODBUS command is listed as follows:

TID (hex)	PID (hex)	Field Length (hex)	UID (hex)	FC (hex)	St_Addr. (hex)	Word Count (hex)	Byte Count (hex)
00 01	00 00	00 0B	01	10	1F 40	00 02	04
Register[]		Value (hex)		Remarks			
0		0C 31		Sub_function code			
1		00 01		axis (1: AXIS_X)			

## 4.7 Get DI Signal

### 4.7.1 Get Single DI Signal Status

※Δ eRET ETM\_MACRO\_GET\_DI\_SIGNAL (HANDLE *hEtm*, BYTE *cardNo*, BYTE *axis*, BYTE *nType*)

#### Description:

This function reads the digital input (DI) signal.

#### Category:

MODBUS sub\_function; MP, ISR.

#### Parameters:

Paramters	Description
<i>hEtm</i> :	TCP/IP connection handle
<i>cardNo</i> :	1 (ET-M8194H supports only one i-8094H module)
<i>axis</i> :	Axis or axes (Please refer to Table 3) The axis can be either X, Y, Z or U (1 or 2 or 4 or 8)
<i>nType</i> :	0 → NHOME/IN0 signal 1 → HOME/IN1 signal 2 → Index/IN2 signal 3 → IN3 signal 4 → EXP+ (External input) signal 5 → EXP- (External input) signal 6 → INP signal 7 → ALARM signal

#### Return:

0: Success; Others: Fail (Please refer to chapter 2.2)

#### MODBUS example:

- It is used for creating the content of an MP.

The read DI signal will be executed only when the MP is called. Therefore, use **FC = 16** to write this command inside a MP. This kind of usage often has **ETM\_MACRO\_SET\_RVAR()** followed to get the return DI signal value. Please refer to MP related explanation literature.

**ETM\_MACRO\_GET\_DI\_SIGNAL** (hEtm, 1, AXIS\_X, 1);

The MODBUS command is listed as follows:

TID (hex)	PID (hex)	Field Length (hex)	UID (hex)	FC (hex)	St_Addr. (hex)	Word Count (hex)	Byte Count (hex)
00 01	00 00	00 0D	01	10	1F 40	00 03	06
Register[]		Value (hex)		Remarks			
0		0C 40		<i>Sub_function code</i>			
1		00 01		<i>axis</i>			
2		00 01		<i>The specified DI signal (HOME)</i>			



## 4.7.2 Get All DI Signal Status

**eRET ETM\_GET\_DI\_SIGNAL\_ALL (HANDLE *hEtm*, BYTE *cardNo*, BYTE *axis* , WORD\* *DiSignalValue*)**

**※Δ eRET ETM\_MACRO\_GET\_DI\_SIGNAL \_ALL (HANDLE *hEtm*, BYTE *cardNo*, BYTE *axis*)**

**eRET ETM\_GET\_DI\_SIGNAL\_ALL\_4\_AXIS (HANDLE *hEtm*, BYTE *cardNo*, WORD\* *DiSignalValueX*, WORD\* *DiSignalValueY*, WORD\* *DiSignalValueZ*, WORD\* *DiSignalValueU*)**

### Description:

This function reads the digital input (DI) signal.

### Category:

MODBUS table, MODBUS sub\_function; RTC, MP and ISR.

### Parameters:

Paramters	Description
<i>hEtm</i> :	TCP/IP connection handle
<i>cardNo</i> :	1 (ET-M8194H supports only one i-8094H module)
<i>axis</i> :	Axis or axes (Please refer to Table 3) The axis can be either X, Y, Z or U (1 or 2 or 4 or 8)
<i>DiSignalValue</i> :	The pointer to the memory that stores the all DI Status The bits in DValue are defined as follows: Bit 0 → NHOME/IN0 signal Bit 1 → HOME/IN1 signal Bit 2 → Index/IN2 signal Bit 3 → IN3 signal Bit 4 → EXP+ (External input) signal Bit 5 → EXP- (External input) signal Bit 6 → INP signal Bit 7 → ALARM signal
<i>DiSignalValueX</i> :	The pointer to the memory that stores the all DI Status of x axis
<i>DiSignalValueY</i> :	The pointer to the memory that stores the all DI Status of y axis
<i>DiSignalValueZ</i> :	The pointer to the memory that stores the all DI Status of z axis
<i>DiSignalValueU</i> :	The pointer to the memory that stores the all DI Status of u axis

### Return:

0: Success; Others: Fail (Please refer to chapter 2.2)

**MODBUS example:**

- **Method 1:** It is used for getting current DI signal.

Each bit corresponds to a register. Each register's value is either 0 or 1.

**WORD DIValue;**

**ETM\_GET\_DI\_SIGNAL\_ALL** (hEtm, 1, AXIS\_X, &DIValue);

The MODBUS command is listed as follows:

TID (hex)	PID (hex)	Field Length (hex)	UID (hex)	FC (hex)	St_Addr. (hex)	Word Count (hex)
00 01	00 00	00 06	01	04	00 58	00 01

The response via MODBUS may be:

TID (hex)	PID (hex)	Field Length (hex)	UID (hex)	FC (hex)	Byte Count (hex)	DI Status of AXIS_X. ( Reg_0 )
00 01	00 00	00 05	01	04	02	00 00

- **Method 2:** When it is used inside an MP.

The get DI signal function will be executed only when the MP is called. Therefore, use **FC = 16** to write this command inside a MP. This kind of usage often has **ETM\_MACRO\_SET\_RVAR()** followed to get the return DI value. Please refer to MP-related explanation literature.

**ETM\_MACRO\_GET\_DI\_SIGNAL\_ALL** (hEtm, 1, AXIS\_X);

**//ETM\_MACRO\_SET\_RVAR**(hEtm, 1, VAR0); **//assign this DI value to**  
**//VAR0**

The MODBUS command is listed as follows:

TID (hex)	PID (hex)	Field Length (hex)	UID (hex)	FC (hex)	St_Addr. (hex)	Word Count (hex)	Byte Count (hex)
00 01	00 00	00 0B	01	10	1F 40	00 02	04
Register[]		Value (hex)		Remarks			
0		0C 41		Sub_function code			
1		00 01		axis (1: AXIS_X)			

## 4.8 Get Home Status

**eRET** ETM\_GET\_HOME\_SEARCH\_STATE (**HANDLE** *hEtm*, **BYTE** *cardNo*, **BYTE** *axis* , **WORD\*** *HomeStatus*)

※**Δ eRET** ETM\_MACRO\_GET\_HOME\_SEARCH\_STATE (**HANDLE** *hEtm*, **BYTE** *cardNo*, **BYTE** *axis*)

**eRET** ETM\_GET\_HOME\_SEARCH\_STATE\_4\_AXIS (**HANDLE** *hEtm*, **BYTE** *cardNo*, **WORD\*** *HomeStatusX*, **WORD\*** *HomeStatusY*, **WORD\*** *HomeStatusZ*, **WORD\*** *HomeStatusU*)

### Description:

This function reads the home search state.

### Category:

MODBUS table, MODBUS sub\_function; RTC, MP and ISR.

### Parameters:

Paramters	Description
<i>hEtm</i> :	TCP/IP connection handle
<i>cardNo</i> :	1 (ET-M8194H supports only one i-8094H module)
<i>axis</i> :	Axis or axes (Please refer to Table 3) The axis can be either X, Y, Z or U (1 or 2 or 4 or 8)
<i>HomeStatus</i> :	The pointer to the memory that stores the home status The value in HomeStatus are defined as follows: 0 → Waits for an automatic home search execution command 3 → Execution step 1 : Waits for activation of the IN0 signal in the specified search direction 8 → Execution step 2: Waits for activation of the IN1 signal in the direction opposite to the specified search direction (irregular operation) 12→Execution step 2: Waits for detivation of the IN1 signal in the direction opposite to the specified search direction (irregular operation) 15→Execution step 2: Waits for activation of the IN1 signal in the specified search direction 20→Execution step 3: Waits for activation of the IN2 signal in the specified search direction

	25→Execution step 4: Offset driving in the specified search direction
<i>HomeStatusX:</i>	The pointer to the memory that stores the home status of x axis
<i>HomeStatusY:</i>	The pointer to the memory that stores the home status of y axis
<i>HomeStatusZ:</i>	The pointer to the memory that stores the home status of z axis
<i>HomeStatusU:</i>	The pointer to the memory that stores the home status of u axis

Return:

0: Success; Others: Fail (Please refer to chapter 2.2)

MODBUS example:

- Method 1: It is used for getting current home state

```
WORD HomeStatus;
ETM_GET_HOME_SEARCH_STATE (hEtm, 1, AXIS_X, &HomeStatus);
```

The MODBUS command is listed as follows:

TID (hex)	PID (hex)	Field Length (hex)	UID (hex)	FC (hex)	St_Addr. (hex)	Word Count (hex)
00 01	00 00	00 06	01	04	00 5C	00 01

The response via MODBUS may be:

TID (hex)	PID (hex)	Field Length (hex)	UID (hex)	FC (hex)	Byte Count (hex)	Home State of AXIS_X. ( Reg_0 )
00 01	00 00	00 05	01	04	02	00 00

- Method 2: When it is used inside an MP.

The get home state function will be executed only when the MP is called. Therefore, use **FC = 16** to write this command inside a MP. This kind of usage often has **ETM\_MACRO\_SET\_RVAR()** followed to get the return home state value. Please refer to MP-related explanation literature.

```
ETM_MACRO_GET_HOME_STATE(hEtm, 1, AXIS_X);
//ETM_MACRO_SET_RVAR(hEtm, 1, VAR0); //assign this home state
//value to VAR0
```

The MODBUS command is listed as follows:

TID (hex)	PID (hex)	Field Length (hex)	UID (hex)	FC (hex)	St_Addr. (hex)	Word Count (hex)	Byte Count (hex)
00 01	00 00	00 0B	01	10	1F 40	00 02	04
Register[]		Value (hex)		Remarks			
0		0C 42		<i>Sub_function code</i>			
1		00 01		<i>axis (1: AXIS_X)</i>			

## 4.9 Get and Clear Error Status

### 4.9.1 Check Error Status

```
eRET ETM_GET_ERROR_STATE (HANDLE hEtm, BYTE cardNo,  
BYTE* ErrState)  
※Δ eRET ETM_MACRO_GET_ERROR (HANDLE hEtm, BYTE cardNo)
```

#### Description:

This function checks whether an error occurred or not.

#### Category:

MODBUS table, MODBUS sub\_function; RTC, MP and ISR.

#### Parameters:

Parameters	Description
<i>hEtm</i> :	TCP/IP connection handle
<i>cardNo</i> :	1 (ET-M8194H supports only one i-8094H module)
<i>ErrState</i> :	The pointer to the memory that stores the error status:  1: Error(s) occurred. Please perform ETM_GET_ERROR_CODE () to get more information.  0: No error.

#### Return:

0: Success; Others: Fail (Please refer to chapter 2.2)

#### MODBUS example:

- Method 1: It is used for getting current status of error.

```
BYTE ErrState;  
ETM_GET_ERROR_STATE (hEtm, 1, &ErrState);
```

The MODBUS command is listed as follows:

TID (hex)	PID (hex)	Field Length (hex)	UID (hex)	FC (hex)	St_Addr. (hex)	Word Count (hex)
00 01	00 00	00 06	01	04	00 46	00 01

The response via MODBUS may be:

TID (hex)	PID (hex)	Field Length (hex)	UID (hex)	FC (hex)	Byte Count (hex)	Error status ( Reg_0 )
00 01	00 00	00 05	01	04	02	00 00

- Method 2: It is used for creating the content of an MP.

For this case, users do not actually want to get the current error status. The getting error will be executed only when the MP is called. Therefore, use **FC = 16** to write this command inside a MP. This kind of usage often has **ETM\_MACRO\_SET\_RVAR()** followed to get the return value. Please refer to MP related explanation literature.

**ETM\_MACRO\_GET\_ERROR** (hEtm, 1);

The MODBUS command is listed as follows:

TID (hex)	PID (hex)	Field Length (hex)	UID (hex)	FC (hex)	St_Addr. (hex)	Word Count (hex)	Byte Count (hex)
00 01	00 00	00 09	01	10	1F 40	00 01	02
Register[]		Value (hex)		Remarks			
0		0C 2F		Sub_function code			

## 4.9.2 Get Error Code

**eRET ETM\_GET\_ERROR\_CODE (HANDLE hEtm, BYTE cardNo, BYTE axis, WORD\* ErrCode)**

**※Δ eRET ETM\_MACRO\_GET\_ERROR\_CODE (HANDLE hEtm, BYTE cardNo, BYTE axis)**

**eRET ETM\_GET\_ERROR\_CODE\_4\_AXIS (HANDLE hEtm, BYTE cardNo, WORD\* ErrCodeX, WORD\* ErrCodeY, WORD\* ErrCodeZ, WORD\* ErrCodeU)**

### Description:

This function reads the ERROR status.

### Category:

MODBUS table, MODBUS sub\_function; RTC, MP and ISR.

### Parameters:

Paramters	Description
<b>hEtm:</b>	TCP/IP connection handle
<b>cardNo:</b>	1 (ET-M8194H supports only one i-8094H module)
<b>axis:</b>	Axis or axes (Please refer to Table 3) The axis can be either X, Y, Z or U (1 or 2 or 4 or 8)
<b>ErrCode:</b>	The pointer to the memory that stores the error status
<b>ErrCodeX:</b>	The pointer to the memory that stores the error status of x axis
<b>ErrCodeY:</b>	The pointer to the memory that stores the error status of y axis
<b>ErrCodeZ:</b>	The pointer to the memory that stores the error status of z axis
<b>ErrCodeU:</b>	The pointer to the memory that stores the error status of u axis

### ErrCode:

0 → No error.

For non-zero return value, please refer to the following table. If there are more than one error, the return value will be the sum of there error code values.



Erro Code	Cause of stop	Explanation
1	SOFT LIMIT+	Occurs when the forward software limit is asserted
2	SOFT LIMIT-	Occurs when the reverse software limit is asserted
4	LIMIT+	Occurs when the forward hardware limit is asserted
8	LIMIT-	Occurs when the reverse hardware limit is asserted
16	ALARM	Occurs when the ALARM is asserted
32	EMERGENCY	Occurs when the EMG is asserted
64	Reserved	Reserved
128	HOME	Occurs when both Z phase and HOME are asserted
256	SOFT STOP	Occurs when the software stop is asserted(use function ETM_STOP_SLOWLY, ETM_STOP_SUDDENLY, ETM_VSTOP_SLOWLY, ETM_VSTOP_SUDDENLY)
512	SOFT EMG	Occurs when the software EMG is asserted(use function ETM_EMERGENCY_STOP)

For example, a return code **48** means that ALARM and EMGERENCY occur at the same time.

Return:

0: Success; Others: Fail (Please refer to chapter 2.2)

MODBUS example:

- Method 1: It is used for getting current error code.

WORD *ErrCode*;

**ETM\_GET\_ERROR\_CODE** (hEtm, 1, AXIS\_X, &ErrCode);

The MODBUS command is listed as follows:

TID (hex)	PID (hex)	Field Length (hex)	UID (hex)	FC (hex)	St_Addr. (hex)	Word Count (hex)
00 01	00 00	00 06	01	04	00 14	00 01

The response via MODBUS may be:

TID (hex)	PID (hex)	Field Length (hex)	UID (hex)	FC (hex)	Byte Count (hex)	ErrCode ( Reg_0 )
00 01	00 00	00 05	01	04	02	00 00

- **Method 2:** It is used for creating the content of an MP.

For this case, users do not actually want to get the current error codes. The getting error code will be executed only when the MP is called. Therefore, use **FC = 16** to write this command inside a MP. This kind of usage often has **ETM\_MACRO\_SET\_RVAR()** followed to get the return value. Please refer to MP related explanation literature.

**ETM\_MACRO\_GET\_ERROR\_CODE** (hEtm, 1, AXIS\_X);

The MODBUS command is listed as follows:

TID (hex)	PID (hex)	Field Length (hex)	UID (hex)	FC (hex)	St_Addr. (hex)	Word Count (hex)	Byte Count (hex)
00 01	00 00	00 0B	01	10	1F 40	00 02	04
Register[]		Value (hex)		Remarks			
0		0C 30		<i>Sub_function code</i>			
1		00 01		<i>axis (AXIS_X)</i>			

## 4.10 Get Buffer Status

**eRET** ETM\_GET\_FREE\_BUFFER(**HANDLE** *hEtm*, **BYTE** *cardNo*, **BYTE\*** *FreeBufNum*)

### Description:

This function returns the number of commands the internal FIFO buffer can still store. A maximum of 30 commands can be stored by the FIFO can store. All arriving commands are first stored in the FIFO buffer before they are processed.

### Category:

MODBUS table ; RTC.

### Parameters:

Paramters	Description
<i>hEtm</i> :	TCP/IP connection handle
<i>cardNo</i> :	1 (ET-M8194H supports only one i-8094H module)
<i>FreeBufNum</i> :	Number of empty command lines in the FIFO buffer of the i-8094H

### Return:

0: Success; Others: Fail (Please refer to chapter 2.2)

### MODBUS example:

```
BYTE FreeBufNum;
ETM_GET_FREE_BUFFER(hEtm, 1, & FreeBufNum);
```

The MODBUS command is listed as follows:

TID (hex)	PID (hex)	Field Length (hex)	UID (hex)	FC (hex)	St_Addr. (hex)	Word Count (hex)
00 01	00 00	00 06	01	04	00 47	00 01

The response via MODBUS may be:

TID (hex)	PID (hex)	Field Length (hex)	UID (hex)	FC (hex)	Byte Count (hex)	Block_Num (hex)
00 01	00 00	00 05	01	04	02	00 1E

The returned value, 0x1E, means 30 blocks of command-buffer are available.

## 4.11 Get Stop Status

```
eRET ETM_GET_STOP_STATUS(HANDLE hEtm, BYTE cardNo, BYTE axis, BYTE* StopState)
```

```
eRET ETM_GET_STOP_STATUS_4_AXIS(HANDLE hEtm, BYTE cardNo, BYTE* StopStateX, BYTE* StopStateY, BYTE* StopStateZ, BYTE* StopStateU)
```

### Description:

This function reads current stop status.

### Category:

MODBUS table ; RTC.

### Parameters:

Parameters	Description
<i>hEtm:</i>	TCP/IP connection handle
<i>cardNo:</i>	1 (ET-M8194H supports only one i-8094H module)
<i>axis:</i>	Axis or axes (Please refer to Table 3) The axis can be either X, Y, Z or U (1 or 2 or 4 or 8).
<i>StopState:</i>	The pointer to the memory that stores the stop status
<i>StopStateX:</i>	The pointer to the memory that stores the stop status of x axis
<i>StopStateY:</i>	The pointer to the memory that stores the stop status of y axis
<i>StopStateZ:</i>	The pointer to the memory that stores the stop status of z axis
<i>StopStateU:</i>	The pointer to the memory that stores the stop status of u axis

### Return:

0: Success; Others: Fail (Please refer to chapter 2.2)

**MODBUS example:**

STOP status	Address	Remarks
X_STOP_STATUS	58 (0x3A)	1 → AXIS_X has stopped 0 → AXIS_X is moving
Y_STOP_STATUS	59 (0x3B)	1 → AXIS_Y has stopped 0 → AXIS_Y is moving
Z_STOP_STATUS	60 (0x3C)	1 → AXIS_Z has stopped 0 → AXIS_Z is moving
U_STOP_STATUS	61 (0x3D)	1 → AXIS_U has stopped 0 → AXIS_U is moving

**BYTE** StopState;

ETM\_GET\_STOP\_STATUS (hEtm, 1, AXIS\_X, & StopState);

The MODBUS command is listed as follows:

TID (hex)	PID (hex)	Field Length (hex)	UID (hex)	FC (hex)	St_Addr. (hex)	Word Count (hex)
00 01	00 00	00 06	01	04	00 3A	00 01

The response via MODBUS may be:

TID (hex)	PID (hex)	Field Length (hex)	UID (hex)	FC (hex)	Byte Count (hex)	AXIS Stop_Status (hex)
00 01	00 00	00 05	01	04	02	00 01

## 4.12 Get Software Emergency Status

**eRET ETM\_GET\_EMERGENCY\_STATE (HANDLE *hEtm*, BYTE *cardNo*, BYTE \* *EmgState*)**

### Description:

This function reads the current emergency status generated by the ETM\_CLEAR\_EMERGENCY\_STOP command. In an emergency stop state all four drives are in standstill and remain in standstill until the emergency stop has been cleared.

### Category:

MODBUS table: RTC.

### Parameters:

Parameters	Description
<i>hEtm</i> :	TCP/IP connection handle
<i>cardNo</i> :	1 (ET-M8194H supports only one i-8094H module)
<i>axis</i> :	Axis or axes (Please refer to Table 3) The axis can be either X, Y, Z or U (1 or 2 or 4 or 8)
<i>EmgState</i> :	<ul style="list-style-type: none"> <li>▪ 0: no emergency stop active</li> <li>▪ 1: emergency stop activated</li> </ul>

### Return:

0: Success; Others: Fail (Please refer to chapter 2.2)

### MODBUS example:

Emergency stop status	Address	Remarks
X_STOP_STATUS	25 (0x19)	1 → AXIS_X has stopped 0 → AXIS_X is moving

BYTE *EmgState*;

ETM\_GET\_EMERGENCY\_STATE (*hEtm*, 1, & *EmgState*);

### The MODBUS command is listed as follows:

TID (hex)	PID (hex)	Field Length (hex)	UID (hex)	FC (hex)	St_Addr. (hex)	Word Count (hex)
00 01	00 00	00 06	01	04	00 19	00 01

### The response via MODBUS may be:

TID (hex)	PID (hex)	Field Length (hex)	UID (hex)	FC (hex)	Byte Count (hex)	EmgState (hex)
00 01	00 00	00 05	01	04	02	00 01

## 4.13 Get Driving Axis

```
eRET ETM_GET_DRIVING_AXIS(HANDLE hEtm, BYTE cardNo, BYTE*
    DrvAxis)
```

### Description:

This function returns the currently driving axis.

### Category:

MODBUS table: RTC.

### Parameters:

Parameters	Description
<i>hEtm</i> :	TCP/IP connection handle
<i>cardNo</i> :	1 (ET-M8194H supports only one i-8094H module)
<i>DrvAxis</i> :	<ul style="list-style-type: none"> <li>▪ 0 - no axis running;</li> <li>▪ &gt;0 - each running axis is indicated by a bit (see table Table 3)</li> </ul>

### Return:

0: Success; Others: Fail (Please refer to chapter 2.2)

### MODBUS example:

BYTE DrvAxis;

ETM\_GET\_DRIVING\_AXIS (hEtm, 1, & DrvAxis);

### The MODBUS command is listed as follows:

TID (hex)	PID (hex)	Field Length (hex)	UID (hex)	FC (hex)	St_Addr. (hex)	Word Count (hex)
00 01	00 00	00 06	01	04	00 60	00 01

### The response via MODBUS may be:

TID (hex)	PID (hex)	Field Length (hex)	UID (hex)	FC (hex)	Byte Count (hex)	Driving Axis (hex)
00 01	00 00	00 05	01	04	02	00 01

## 4.14 Get Interpolation Ready Flag

**eRET** ETM\_GET\_INTERPOL\_RDY\_FLAG(**HANDLE** *hEtm*, **BYTE** *cardNo*, **BYTE\*** *InterpolationRdyFlag*)

### Description:

This function indicates whether the motion control chip is ready to process the next interpolation command.

### Category:

MODBUS table: RTC.

### Parameters:

Paramters	Description
<i>hEtm</i> :	TCP/IP connection handle
<i>cardNo</i> :	1 (ET-M8194H supports only one i-8094H module)
<i>InterpolationRdyFlag</i> :	<ul style="list-style-type: none"> <li>▪ 0 - not ready for the next interpolation command</li> <li>▪ 1 - ready for the next interpolation command</li> </ul>

### Return:

0: Success; Others: Fail (Please refer to chapter 2.2)

### MODBUS example:

**BYTE** *InterpolationRdyFlag*;  
 ETM\_GET\_INTERPOL\_RDY\_FLAG (*hEtm*, 1, & *InterpolationRdyFlag*);

### The MODBUS command is listed as follows:

TID (hex)	PID (hex)	Field Length (hex)	UID (hex)	FC (hex)	St_Addr. (hex)	Word Count (hex)
00 01	00 00	00 06	01	04	00 57	00 01

### The response via MODBUS may be:

TID (hex)	PID (hex)	Field Length (hex)	UID (hex)	FC (hex)	Byte Count (hex)	Interpolation RdyFlag (hex)
00 01	00 00	00 05	01	04	02	00 01



## 4.15 Get Triggered Interrupt Factors

```
eRET ETM_GET_TRIG_INTFACTOR (HANDLE hEtm, BYTE cardNo,
                               BYTE nINT, BYTE *pAxis)
```

### Description:

This function reads which axis has triggered an interrupt for the set interrupt factor since the last ETM\_INTFACTOR\_ENABLE function call. The function ETM\_INTFACTOR\_ENABLE enables the motion chip interrupt and clears the interrupt status for the respective interrupt factor.

### Category:

MODBUS table; RTC.

### Parameters:

Paramters	Description
<i>hEtm</i> :	TCP/IP connection handle
<i>cardNo</i> :	1 (ET-M8194H supports only one i-8094H module)
<i>nINT</i> :	Consult Table 6
<i>pAxis</i> :	Consult Table 3 Example: 0x0F: All 4 axis have triggered 0x02: only the Y axis has triggered 0x0B: axis XYU have triggered

The Modbus function code 4 register table is as follows.

Table 6: Motion chip interrupt factor table with respective Modbus FC 4 register addresses

Modbus register address FC4	<i>nINT</i>	Symbol	Description
130	0	PULSE	Interrupt occurs when pulse is up
131	1	P>=C-	Interrupt occurs when the value of logical / real position counter is larger than or equal to that of COMP- register.
132	2	P<C-	Interrupt occurs when the value of logical / real position counter is smaller than that of COMP- register

133	3	P<C+	Interrupt occurs when the value of logical / real position counter is smaller than that of COMP+ register.
134	4	P>=C+	Interrupt occurs when the value of logical / real position counter is larger than or equal to that of COMP+ register.
135	5	C-END	Interrupt occurs at the end of the constant speed drive or completion of Acceleration Offset Pulse output
136	6	C-STA	Interrupt occurs at the start of the constant speed drive or begin of Acceleration Offset Pulse output
137	7	D-END	Interrupt occurs when the driving is finished
138	8	HMEND	Automatic home search terminated
139	9	SYNC	Synchronous action was activated

**Return:**

0: Success; Others: Fail (Please refer to chapter 2.2)

**MODBUS example:**

BYTE bAxis;

ETM\_GET\_TRIG\_INTFACTOR (hEtm, 1, 0, & bAxis);

**MODBUS request:**

TID (hex)	PID (hex)	Field Length (hex)	UID (hex)	FC (hex)	St_Addr. (hex)	Word Count (hex)
00 01	00 00	00 06	01 (Card No.)	04	00 82 (130) (Pulse output)	00 01

**MODBUS response:**

TID (hex)	PID (hex)	Field Length (hex)	UID (hex)	FC (hex)	Byte Count (hex)	Registers (hex)
00 01	00 00	00 05	01	04	02	00 09 (Axis XY triggered)

## 4.16 Get ET-M8194H State

### 4.16.1 Command Download and Execution Procedure

The motion unit basically consists of two modules:

- ET-M8194H
- i-8094H

• The ET-M8194H module (Figure 1) in slot 0 is the unit which is mainly responsible for the Modbus communication between the Master and Slave. The main task of the module is to verify and filter every command arriving at its TCP/IP port according to its current state and consequently decide whether to transfer the command to the i-8094H or, if the command is not supported by the respective state, ignore the command and respond to the Master with a Modbus exception code.

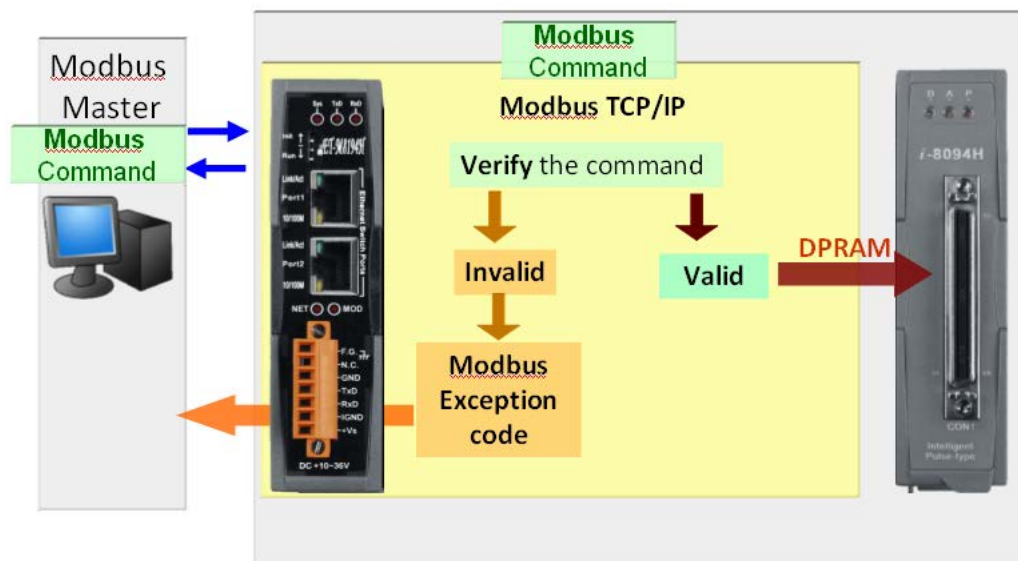

Figure 1: ET-M8194H module in slot 0 of the motion device

The module can be in one of the following three states:

- Ready state
- MP Macro download state
- ISR Macro download state

When the ET-M8194H (module in the first slot is responsible for the communication part) is in a certain state certain commands can not be processed by the module and therefore the module responds with a Modbus exception code when a command is being sent by the Master which is not being supported by the current module state. Table 1 describes for each command the valid scope. When the module is in the ready state all RTC commands marked in Table 1 are valid commands.

For example, the ET-M8194H is in the MP Macro download state. In this state only commands which are marked with MP in Table 1 are valid commands. As soon as a non MP command is being sent (e.g. MP\_CREATE) the module will ignore this command and return a Modbus exception code. The ETM\_GET\_DEVICE\_STATE allows the user to determine the reason for the Modbus exception code by reading the current module state.

- The i-8094H module (Figure 2) in slot 1 is mainly responsible for executing motion commands and storing the Macro tables in its non-volatile memory. The motion control chip and the non-volatile memory for storing Macro tables are part of the i-8094H module. Furthermore it has a DPRAM (volatile FIFO buffer) which stores up to 29 commands for further processing.

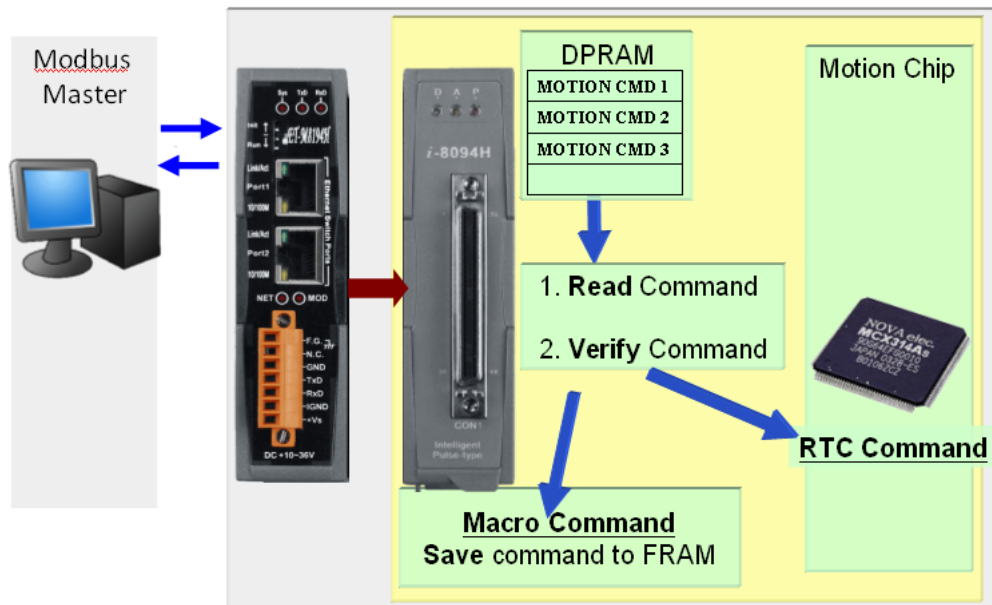

Figure 2: i-8094H situated in slot 1 of the motion device

## 4.16.2 Get ET-M8194H Status

```
eRET ETM_GET_DEVICE_STATE (HANDLE hEtm, BYTE cardNo,  
EtmState *pState)
```

```
typedef struct  
{  
    WORD Etm8194hState;  
    WORD I8094hState;  
    WORD IllegalFuncErr;  
} EtmState;
```

### Description:

This function returns the current state of the ET-M8194H and of the i8094H module and furthermore the cause of the last Modbus exception code.

### Category:

MODBUS table; RTC.

### Parameters:

Parameters	Description
<i>hEtm</i> :	TCP/IP connection handle
<i>cardNo</i> :	1 (ET-M8194H supports only one i-8094H module)
<i>pState</i> :	<b><i>Etm8194hState</i> (Table 7)</b> <b>ETM_READY:</b> Only RTC commands can be sent.  <b>ETM_MP_DOWNLOAD:</b> Only MP Macro commands are accepted.  <b>ETM_ISR_DOWNLOAD:</b> Only ISR Macro commands are valid.  <b><i>I8094hState</i> (Table 8)</b> <b>i8094H_READY:</b> The i-8094H is ready for receiving RTC commands.  <b>i8094H_INITIALIZATION:</b> Executing initialization table (IT commands).  <b>i8094H_MACRO_DOWNLOAD:</b> i-8094H is in the MACRO download mode.  <b>i8094H_MP_EXECUTION:</b> MP Macro table is being executed.

	<p><b>i8094H_ISR_EXECUTION:</b> Interrupt MACRO (ISR) program is being executed.</p> <p><b>i8094H_ERR_FIRMWARE:</b> Module exited the DPRAM scan engine, Module needs to be rebooted.</p> <p><b>i8094H_FIRMWARE_BOOTING:</b> i-8094H firmware has not completed the booting process.</p> <p><i>IllegalFuncErr (Table 9)</i></p> <p><b>ERR_NO_ERROR:</b> No error occurred.</p> <p><b>ERR_FC_NOT_SUPPORTED:</b> Function code not supported.</p> <p><b>ERR_EXCEED_MP_MEMORY:</b> Macro program exceeds the number of command lines reserved for the selected table.</p> <p><b>ERR_MP_INSIDE_ISR:</b> A MP command is being used inside ISR Macro.</p> <p><b>ERR_ISR_INSIDE_MP:</b> An ISR command is being used inside MP Macro.</p> <p><b>ERR_RTC_INSIDE_MP_OR_ISR:</b> A RTC command is being used inside a MP or ISR Macro.</p> <p><b>ERR_MP_OR_ISR_AS_RTC:</b> A MP or ISR Macro command is being used outside a Macro program.</p>
--	--

**Return:**

0: Success; Others: Fail (Please refer to chapter 2.2)

**MODBUS example:**

```
EtmState etmState;
ETM_GET_DEVICE_STATE (hEtm, 1, & etmState);
```

**MODBUS request:**

TID (hex)	PID (hex)	Field Length (hex)	UID (hex)	FC (hex)	St_Addr. (hex)	Word Count (hex)
00 01	00 00	00 06	01 (Card No.)	04	00 64 (100)	00 03

**MODBUS response:**

TID (hex)	PID (hex)	Field Length (hex)	UID (hex)	FC (hex)	Byte Count (hex)	Registers (hex)
00 01	00 00	00 0D	01	04	0A	See next table

Register[]	Value (hex)	Remarks
0	00 01	<i>Etm8194hState</i> : ETM_MP_DOWNLOAD
1	00 03	<i>I8094hState</i> : i8094H_MACRO_DOWNLOAD
2	00 06	<i>IllegalFuncErr</i> : ERR_RTC_INSIDE_MP_OR_ISR

**Table 7: ET-M8194H states**

States of the ET-M8194H module	Number (hex)	Description
ETM_READY	0x00	only RTC commands can be sent
ETM_MP_DOWNLOAD	0x01	only MP Macro commands are accepted
ETM_ISR_DOWNLOAD	0x02	only ISR Macro commands are valid

**Table 8: i-8094H states**

Different states of the i8094H	Number (hex)	Description
i8094H_READY	0x00	The i-8094H is ready for receiving RTC commands
i8094H_INITIALIZATION	0x01	executing initialization table (IT commands)
i8094H_MACRO_DOWNLOAD	0x03	i-8094H is in the MACRO download mode
i8094H_MP_EXECUTION	0x05	MP Macro table is being executed
i8094H_ISR_EXECUTION	0x07	Interrupt MACRO (ISR) program is being executed
i8094H_ERR_FIRMWARE	0x10	i-8094H firmware experienced an error and has to be power off/on
i8094H_FIRMWARE_BOOTING	0xFF	i-8094H firmware has not completed the booting process

**Table 9: Causes of Modbus exception response**

<b>Illegal function errors</b>	<b>Number (hex)</b>	<b>Description</b>
<b>ERR_NO_ERROR</b>	<b>0x00</b>	<b>No error occurred</b>
<b>ERR_FC_NOT_SUPPORTED</b>	<b>0x01</b>	<b>Function code not supported</b>
<b>ERR_EXCEED_MP_MEMORY</b>	<b>0x03</b>	<b>Macro program exceeds the number of command lines reserved for the selected table</b>
<b>ERR_MP_INSIDE_ISR</b>	<b>0x04</b>	<b>A MP command is being used inside ISR macro</b>
<b>ERR_ISR_INSIDE_MP</b>	<b>0x05</b>	<b>A ISR command is being used inside MP macro</b>
<b>ERR_RTC_INSIDE_MP_OR_ISR</b>	<b>0x06</b>	<b>A RTC command is being used inside a MP or ISR macro</b>
<b>ERR_MP_OR_ISR_AS_RTC</b>	<b>0x07</b>	<b>A MP or ISR macro command is being used outside a macro program</b>



---

## 5 FRnet Functions

---

### 5.1 Get FRnet DIO Signals

#### 5.1.1 Read FRnet Group Data (MP)

※Δ eRET ETM\_MACRO\_FRNET\_IN (HANDLE *hEtm*, BYTE *cardNo*, BYTE *wGroup*)

#### Description:

This function reads the FRnet digital input signals. One group comprises 16 bits data. Maximum eight groups of DI are provided. Therefore, total 128 DI can be defined for one FRnet interface.

#### Category:

MODBUS sub\_function; MP, ISR.

#### Parameters:

Paramters	Description
<i>hEtm</i> :	TCP/IP connection handle
<i>cardNo</i> :	1 (ET-M8194H supports only one i-8094H module)
<i>wGroup</i> :	DI group number is between 8~15. If you enter a value between 0 to 7, you can get the output state of the external DO group.

#### Return:

0: Success; Others: Fail (Please refer to chapter 2.2)

#### MODBUS example:

Each register contains 16-bit data. Each bit corresponds to a DI channel in a group.

- It is used for creating the content of an MP.

For this case, users do not actually want to get the current DI value. The getting will be executed only when the MP is called. Therefore, use FC = 16 to write this command inside a MP. This kind of usage often has ETM\_MACRO\_SET\_RVAR() followed to get the return DI value. Please refer to MP related explanation literature.

**ETM\_MACRO\_FRNET\_IN** (hEtm, 1, 8);

The MODBUS command is listed as follows:

TID (hex)	PID (hex)	Field Length (hex)	UID (hex)	FC (hex)	St_Addr. (hex)	Word Count (hex)	Byte Count (hex)
00 01	00 00	00 0B	01	10	1F 40	00 02	04
Register[]		Value (hex)		Remarks			
0		0C 32		<i>Sub_function code</i>			
1		00 08		<i>Group number (8~15)</i>			

## 5.1.2 Read FRnet Channel Data (MP)

※Δ eRET ETM\_MACRO\_FRNET\_READ (HANDLE *hEtm*, BYTE *cardNo*, BYTE *bGroup*, DWORD *dwChannel*)

### Description:

Read the channel data of FRnet group.

### Category:

MODBUS sub\_function; MP, ISR.

### Parameters:

Paramters	Description
<i>hEtm</i> :	TCP/IP connection handle
<i>cardNo</i> :	1 (ET-M8194H supports only one i-8094H module)
<i>wGroup</i> :	DI group number is between 8~15. If you enter a value between 0 to 7, you can get the output state of the external DO group.
<i>dwChannel</i> :	The channel inside the group define the range of 0 to 15.

### Return:

0: Success; Others: Fail (Please refer to chapter 2.2)

### MODBUS example:

**ETM\_MACRO\_FRNET\_READ** (hEtm, 1, 8, 1);

The MODBUS command is listed as follows:

TID (hex)	PID (hex)	Field Length (hex)	UID (hex)	FC (hex)	St_Addr. (hex)	Word Count (hex)	Byte Count (hex)
00 01	00 00	00 11	01	10	1F 40	00 05	0A
Register[]		Value (hex)		Remarks			
0		0C 34		<i>Sub_function code</i>			
1		00 00		<i>MSW of 0x0008</i>			
2		00 08		<i>LSW of 0x0008</i>			
3		00 00		<i>MSW of 0x0001</i>			
4		00 01		<i>LSW of 0x0001</i>			

### 5.1.3 Read FRnet Channel Data (RTC)

**eRET ETM\_FRNET\_READ\_SINGLE\_DIO (HANDLE *hEtm*, BYTE *cardNo*, WORD *wGroup*, BYTE *bChannelNo*, BYTE *\*pbChannelStatus*)**

**Description:**

Read the channel data of FRnet group.

**Category:**

MODBUS table; RTC.

**Parameters:**

Paramters	Description
<i>hEtm</i> :	TCP/IP connection handle
<i>cardNo</i> :	1 (ET-M8194H supports only one i-8094H module)
<i>wGroup</i> :	DI group number is between 8~15. If you enter a value between 0 to 7, you can get the output state of the external DO group.
<i>bChannelNo</i> :	The channel number inside the group defines the range of 0 to 15.
<i>pbChannelStatus</i> :	The pointer to the memory that stores the data which you read from the channel.

**Return:**

0: Success; Others: Fail (Please refer to chapter 2.2)

## 5.1.4 Read FRnet Group Data (RTC)

**eRET ETM\_FRNET\_READ\_GROUP\_DIO** (**HANDLE** *hEtm*, **BYTE** *cardNo*, **WORD** *wGroup*, **WORD\*** *pwGroupStatus*)

### Description:

Read the data of FRnet group.

### Category:

MODBUS table; RTC.

### Parameters:

Paramters	Description
<i>hEtm</i> :	TCP/IP connection handle
<i>cardNo</i> :	1 (ET-M8194H supports only one i-8094H module)
<i>wGroup</i> :	DI group number is between 8~15. If you enter a value between 0 to 7, you can get the output state of the external DO group.
<i>pwGroupStatus</i>	The pointer to the memory that stores the data which you read from the group.

### Return:

0: Success; Others: Fail (Please refer to chapter 2.2)

### MODBUS example:

```
WORD pwGroupStatus;
ETM_MACRO_FRNET_READ(hEtm, 1, 8, &pwGroupStatus);
```

### MODBUS request:

TID (hex)	PID (hex)	Field Length (hex)	UID (hex)	FC (hex)	St_Addr. (hex)	Word Count (hex)
00 01	00 00	00 06	01	04	00 08	00 01

### MODBUS response:

TID (hex)	PID (hex)	Field Length (hex)	UID (hex)	FC (hex)	Byte Count (hex)	<i>pwGroupStatus</i> (hex)
00 01	00 00	00 05	01	04	02	0001

### 5.1.5 Read FRnet Multi-group Data (RTC)

```
eRET ETM_FRNET_READ_MULTI_GROUP_DIO (HANDLE hEtm, BYTE
cardNo, WORD wStartGroup, BYTE bGroupQty, WORD*
pwInputBuffer, BYTE bBufferSize )
```

**Description:**

Read the data of FRnet multi-group.

**Category:**

MODBUS table; RTC.

**Parameters:**

Paramters	Description
<i>hEtm:</i>	TCP/IP connection handle
<i>cardNo:</i>	1 (ET-M8194H supports only one i-8094H module)
<i>wStartGroup:</i>	The starting group.
<i>bGroupQty:</i>	The group quantity.
<i>pwInputBuffer:</i>	The pointer to the memory that store the data which you read from the group.
<i>bBufferSize:</i>	The size of the registers( $bBufferSize*2$ must $\geq bGroupQty$ )

**Return:**

0: Success; Others: Fail (Please refer to chapter 2.2)

**MODBUS example:**

```
WORD pwInputBuffer[2];
ETM_FRNET_READ_MULTI_GROUP_DIO(hEtm, 1, 8, 2, &
pwInputBuffer, 4);
```

**MODBUS request:**

TID (hex)	PID (hex)	Field Length (hex)	UID (hex)	FC (hex)	St_Addr. (hex)	Word Count (hex)
00 01	00 00	00 06	01	04	00 08	00 02

**MODBUS response:**

TID (hex)	PID (hex)	Field Length (hex)	UID (hex)	FC (hex)	Byte Count (hex)	<i>pwInputBuffer</i> [0] (hex)	<i>pwInputBuffer</i> [1] (hex)
00 01	00 00	00 07	01	04	04	00 01	00 03

## 5.2 Set FRnet DO

### 5.2.1 Set FRnet DO Group Data (MP)

※Δ eRET ETM\_MACRO\_FRNET\_OUT (HANDLE *hEtm*, BYTE *cardNo*, BYTE *bGroup*, DWORD *data*)

#### Description:

This function writes data to the FRnet digital output. One group comprises 16 bits data. Maximum eight groups of DO are provided. Therefore, total 128 DO can be defined for one FRnet interface.

#### Category:

MODBUS table, MODBUS sub\_function; MP, ISR.

#### Parameters:

Paramters	Description
<i>hEtm</i> :	TCP/IP connection handle
<i>cardNo</i> :	1 (ET-M8194H supports only one i-8094H module)
<i>bGroup</i> :	Group number is between 0~7. Eight or above is not defined.
<i>data</i> :	0x00000000 ~ 0x0000ffff, can also use VARn to set.

#### Return:

0: Success; Others: Fail (Please refer to chapter 2.2)

#### MODBUS example:

- Method 1: It is used for setting FRnet DO values by some true values. Each register contains 16-bit data. Each bit corresponds to a DO of group. Please note that FRnet DO values can be read back.

```
ETM_MACRO_FRNET_OUT (hEtm, 1, 0, 0x0000FFFF);  
ETM_MACRO_FRNET_OUT (hEtm, 1, 1, 0x0000AAAA);  
ETM_MACRO_FRNET_OUT (hEtm, 1, 2, 0x00001100);  
ETM_MACRO_FRNET_OUT (hEtm, 1, 3, 0x00000011);
```

TID (hex)	PID (hex)	Field Length (hex)	UID (hex)	FC (hex)	St_Addr. (hex)	Word Count (hex)	Byte Count (hex)
00 01	00 00	00 0F	01	10	00 00	00 04	08
Register[]		Value (hex)		Remarks			
0		FF FF		DO setting (for address = 0)			
1		AA AA		DO setting (for address = 1)			
2		11 00		DO setting (for address = 2)			
3		00 11		DO setting (for address = 3)			

- Method 2: It can be used for setting FRnet DO values by true values or by variables.

The DO is defined as a DWORD because it can be a variable or a true value. When a VARn is used instead of the true value, the MSW will not be zero. When users desire to use a true value to set the DO, please keep the MSW to be zero, and let the LSW part contain the DO value.

```
ETM_MACRO_FRNET_OUT (hEtm, 1, 0, 0x0000FFFF);
// on module 1, set group number RA=0, output data is 0x0000ffff
```

The MODBUS command is listed as follows:

TID (hex)	PID (hex)	Field Length (hex)	UID (hex)	FC (hex)	St_Addr. (hex)	Word Count (hex)	Byte Count (hex)
00 01	00 00	00 0F	01	10	1F 40	00 04	08
Register[]		Value (hex)		Remarks			
0		0C 33		Sub_function code			
1		00 00		Group number (0~7)			
2		00 00		MSW of DO			
3		FF FF		LSW of DO			

```
ETM_MACRO_FRNET_OUT (hEtm, 1, bVAR0, VAR1);
// on module 1, set group number RA= bVAR0, output data is VAR1
```

Note: The address of bVAR0 is 0x80 (= 0x80+n); and the start address of VAR1 is 0x012E (= 300 + 2\*n).



The MODBUS command is listed as follows:

TID (hex)	PID (hex)	Field Length (hex)	UID (hex)	FC (hex)	St_Addr. (hex)	Word Count (hex)	Byte Count (hex)
00 01	00 00	00 0F	01	10	1F 40	00 04	08
Register[]		Value (hex)		Remarks			
0		0C 33		<i>Sub_function code</i>			
1		00 80		<i>bVAR0</i>			
2		00 00		<i>MSW of VAR1</i>			
3		01 2E		<i>LSW of VAR1</i>			

## 5.2.2 Set FRnet DO Channel Data (MP)

※Δ eRET ETM\_MACRO\_FRNET\_WRITE (HANDLE *hEtm*, BYTE *cardNo*, BYTE *bDoGroup*, DWORD *dwChannel*, DWORD *dwOutput*)

### Description:

Write data to the channel of FRnet DO group.

### Category:

MODBUS sub\_function; MP, ISR.

### Parameters:

Paramters	Description
<i>hEtm</i> :	TCP/IP connection handle
<i>cardNo</i> :	1 (ET-M8194H supports only one i-8094H module)
<i>bDoGroup</i> :	Group number is between 0~7. Eight or above is not defined.
<i>dwChannel</i> :	The channel of the group is defined 0~15.
<i>dwOutput</i> :	The written data.

### Return:

0: Success; Others: Fail (Please refer to chapter 2.2)

### MODBUS example:

ETM\_MACRO\_FRNET\_WRITE(*hEtm*, 1, 1, 1, 1);

The MODBUS command is listed as follows:

TID (hex)	PID (hex)	Field Length (hex)	UID (hex)	FC (hex)	St_Addr. (hex)	Word Count (hex)	Byte Count (hex)
00 01	00 00	00 15	01	10	1F 40	00 07	0E
Register[]		Value (hex)		Remarks			
0		0C 35		Sub_function code			
1		00 00		MSW of 0x0001			
2		00 01		LSW of 0x0001			
3		00 00		MSW of 0x0001			
4		00 01		LSW of 0x0001			
5		00 00		MSW of 0x0001			
6		00 01		LSW of 0x0001			

### 5.2.3 Set FRnet DO Channel Data (RTC)

**eRET ETM\_FRNET\_WRITE\_SINGLE\_DO (HANDLE *hEtm*, BYTE *cardNo*, BYTE *bGroup*, DWORD *dwChannelNo*, BYTE *bOutput*)**

**Description:**

Write data to the channel of FRnet DO group.

**Category:**

MODBUS table ; RTC.

**Parameters:**

Paramters	Description
<i>hEtm</i> :	TCP/IP connection handle
<i>cardNo</i> :	1 (ET-M8194H supports only one i-8094H module)
<i>bGroup</i> :	Group number is between 0~7. Eight or above is not defined.
<i>dwChannelNo</i> :	The channel of the group is defined 0~15.
<i>bOutput</i> :	The written data.

**Return:**

0: Success; Others: Fail (Please refer to chapter 2.2)

**MODBUS example:**

ETM\_FRNET\_WRITE\_SINGLE\_DO (*hEtm*, 1, *bGroup*, *dwChannelNo*, 1);

**The MODBUS command is listed as follows:**

TID (hex)	PID (hex)	Field Length (hex)	UID (hex)	FC (hex)	St_Addr. (hex)	Value (hex)
00 01	00 00	00 09	01	05	( <i>bGroup</i> * 16 + <i>dwChannelNo</i> )	00 00(off); FF 00(on)

## 5.2.4 Set FRnet DO Group Data (RTC)

**eRET** ETM\_FRNET\_WRITE\_GROUP\_DO (**HANDLE** *hEtm*, **BYTE** *cardNo*, **BYTE** *bGroup*, **DWORD** *dwdata*)

### Description:

Write data to FRnet DO group.

### Category:

MODBUS table ; RTC.

### Parameters:

Paramters	Description
<i>hEtm</i> :	TCP/IP connection handle
<i>cardNo</i> :	1 (ET-M8194H supports only one i-8094H module)
<i>bGroup</i> :	Group number is between 0~7. Eight or above is not defined.
<i>dwdata</i> :	0x00000000 ~ 0x0000ffff, can also use VARn to set.

### Return:

0: Success; Others: Fail (Please refer to chapter 2.2)

### MODBUS example:

ETM\_FRNET\_WRITE\_GROUP\_DO(*hEtm*, 1, 0, 0x0000FFFF); // on module 1, set group number RA=0, output data is 0x0000ffff

The MODBUS command is listed as follows:

TID (hex)	PID (hex)	Field Length (hex)	UID (hex)	FC (hex)	St_Addr. (hex)	Word Count (hex)	Byte Count (hex)
00 01	00 00	00 0B	01	10	00 00	00 02	04
Register[]		Value (hex)		Remarks			
0		00 00		MSW of 0xFFFF			
1		FF FF		LSW of 0xFFFF			

## 5.2.5 Set FRnet Multi-group DO Data (RTC)

```
eRET ETM_FRNET_WRITE_MULTI_GROUP_DO (HANDLE hEtm, BYTE  
cardNo, WORD wStartGroup, BYTE bGroupQty, WORD*  
pwOutBuffer, BYTE bBufferSize)
```

### Description:

Write data to FRnet DO multi-group.

### Category:

MODBUS table ; RTC.

### Parameters:

Paramters	Description
<i>hEtm</i> :	TCP/IP connection handle
<i>cardNo</i> :	1 (ET-M8194H supports only one i-8094H module)
<i>wStartGroup</i> :	The starting group.
<i>bGroupQty</i> :	The group quantity.
<i>pwOutBuffer</i> :	The pointer points to the memory that store the data of group which you want to write.
<i>bBufferSize</i> :	The size of the registers ( $bBufferSize * 2 \geq bGroupQty$ )

### Return:

0: Success; Others: Fail (Please refer to chapter 2.2)

### MODBUS example:

```
WORD pwOutBuffer[4];  
pwOutBuffer[0]=0xFFFF;  
pwOutBuffer[1]=0xAAAA;  
pwOutBuffer[2]=0x1100;  
pwOutBuffer[3]=0x0011;  
ETM_FRNET_WRITE_MULTI_GROUP_DO(hEtm, 1, 0, 4, &  
pwOutBuffer, 8);
```

The MODBUS command is listed as follows:

TID (hex)	PID (hex)	Field Length (hex)	UID (hex)	FC (hex)	St_Addr. (hex)	Word Count (hex)	Byte Count (hex)
00 01	00 00	00 0F	01	10	00 00	00 04	08
Register[]		Value (hex)		Remarks			
0		FF FF		DO setting (for address = 0)			
1		AA AA		DO setting (for address = 1)			
2		11 00		DO setting (for address = 2)			
3		00 11		DO setting (for address = 3)			

## 5.3 FRnet Wait

※Δ eRET ETM\_MACRO\_FRNET\_WAIT (HANDLE hEtm, BYTE cardNo, BYTE bDiGroup, DWORD dwChannel, DWORD dwDiInput, DWORD dwTimeout)

### Description:

Wait until FRnet DI turned ON.

### Category:

MODBUS sub\_function; MP, ISR.

### Parameters:

Paramters	Description
<i>hEtm</i> :	TCP/IP connection handle
<i>cardNo</i> :	1 (ET-M8194H supports only one i-8094H module)
<i>bDiGroup</i> :	Group number, 8~15
<i>dwChannel</i> :	The channel of the group is defined 0~15.
<i>dwDiInput</i> :	1:ON, 0:OFF
<i>dwTimeout</i> :	The waiting time(ms) 0: Represent the waiting time is infinite until ON. n: Represent only wait n(ms).

### Return:

0: Success; Others: Fail (Please refer to chapter 2.2)

### MODBUS example:

ETM\_MACRO\_FRNET\_WAIT(hEtm, 1, 8, 1, 1, 1000);

The MODBUS command is listed as follows:

TID (hex)	PID (hex)	Field Length (hex)	UID (hex)	FC (hex)	St_Addr. (hex)	Word Count (hex)	Byte Count (hex)
00 01	00 00	00 17	01	10	1F 40	00 08	10
Register[]		Value (hex)		Remarks			
0		0C 36		Sub_function code			
1		00 08		bDiGroup			
2		00 00		MSW of 0x0001			
3		00 01		LSW of 0x0001			
4		00 00		MSW of 0x0001			
5		00 01		LSW of 0x0001			
6		00 00		MSW of 0x03E8			
7		03 E8		LSW of 0x03E8			

## 5.4 FRnet DI Trigger Event Setting

```
eRET ETM_SET_FRNET_TRIGGER_EVENT(HANDLE hEtm, BYTE
cardNo, BYTE bEnableDisable)
```

### Description:

This function enables the FRnet DI trigger event setting. Once this function has been called the FRnet DI trigger table set by the EzMove utility will be activated (see chapter 10)

### Category:

RTC.

### Parameters:

Paramters	Description
<i>hEtm:</i>	TCP/IP connection handle
<i>cardNo:</i>	1 (ET-M8194H supports only one i-8094H module)
<i>bEnableDisable:</i>	0-disable; 1-enabled

### Return:

0: Success; Others: Fail (Please refer to chapter 2.2)

### MODBUS example:

```
ETM_SET_FRNET_TRIGGER_EVENT (hEtm, 1, 1);
```

The MODBUS command is listed as follows:

TID (hex)	PID (hex)	Field Length (hex)	UID (hex)	FC (hex)	St_Addr. (hex)	Word Count (hex)	Byte Count (hex)
00 01	00 00	00 09	01	10	00 09	00 01	02
Register[]		Value (hex)		Remarks			
0		00 01		0-disable; 1-enabled			



## 5.5 Get FRnet DI Trigger Event Setting

```
eRET ETM_GET_FRNET_TRIGGER_EVENT_SETTING(HANDLE hEtm,
      BYTE cardNo, BYTE *pbEnableDisable)
```

### Description:

This function reads the current the FRnet DI trigger event setting. (See chapter 10)

Category:  
RTC.

### Parameters:

Paramters	Description
<i>hEtm:</i>	TCP/IP connection handle
<i>cardNo:</i>	1 (ET-M8194H supports only one i-8094H module)
<i>pbEnableDisable:</i>	0-disable; 1-enabled

### Return:

0: Success; Others: Fail (Please refer to chapter 2.2)

### MODBUS example:

```
BYTE bSetting;
ETM_GET_FRNET_TRIGGER_EVENT_SETTING (hEtm, 1, & bSetting);
```

The MODBUS command is listed as follows:

TID (hex)	PID (hex)	Field Length (hex)	UID (hex)	FC (hex)	St_Addr. (hex)	Word Count (hex)
00 01	00 00	00 06	01	03	00 09	00 01

---

## 6 Auto Homing Search

---

i-8094H module provides automatic home search function. After the configuration of proper settings, the whole process for Homing searching can function automatically. The main steps are as follows:

- Near-home sensor searching (NHOME) under high-speed motion.
- Home sensor searching under low-speed motion.
- Servo motor Z-Phase searching under low-speed motion.
- Offset movement to the origin of the working area under high-speed motion.

A few steps could be skipped by adjusting settings accordingly to meet customer's actual needs. This operation could be performed automatically, therefore economize on CPU resource and reduce programming efforts.

## 6.1 Set Home Search Speed

eRET ETM_SET_HV (HANDLE <i>hEtm</i> , BYTE <i>cardNo</i> , BYTE <i>axis</i> , DWORD <i>data</i> )
※ eRET ETM_MACRO_SET_HV (HANDLE <i>hEtm</i> , BYTE <i>cardNo</i> , BYTE <i>axis</i> , DWORD <i>data</i> )

### Description:

This function sets the homing search speed.

### Category:

MODBUS sub\_function; RTC and MP.

### Parameters:

Paramters	Description
<i>hEtm</i> :	TCP/IP connection handle
<i>cardNo</i> :	1 (ET-M8194H supports only one i-8094H module)
<i>axis</i> :	Axis or axes (Please refer to Table 3) The axis can be either X, Y, Z or U (1 or 2 or 4 or 8)
<i>data</i> :	Homing speed (Vmin~Vmax PPS).

### Return:

0: Success; Others: Fail (Please refer to chapter 2.2)

### Remark:

The Sub\_function code of ETM\_SET\_HV is 0A 3C.

The Sub\_function code of ETM\_MACRO\_SET\_HV is 0C 3C.

### MODBUS example:

ETM\_SET\_HV (hEtm, 1, AXIS\_X, 500);

//set the homing speed of the X axis on module 1 to be 500 PPS.

The MODBUS command is listed as follows:

TID (hex)	PID (hex)	Field Length (hex)	UID (hex)	FC (hex)	St_Addr. (hex)	Word Count (hex)	Byte Count (hex)
00 01	00 00	00 0F	01	10	1F 40	00 04	08
Register[]		Value (hex)		Remarks			
0		0A 3C/0C 3C		Sub_function code			
1		00 01		axis			
2		00 00		MSW of data			
3		01 F4		LSW of data (500 = 0x1F4)			

## 6.2 Limit Switch as the Home Sensor Setting

<p>eRET ETM_HOME_LIMIT (HANDLE <i>hEtm</i>, BYTE <i>cardNo</i>, BYTE <i>axis</i>, BYTE <i>nType</i>)</p> <p>※ eRET ETM_MACRO_HOME_LIMIT (HANDLE <i>hEtm</i>, BYTE <i>cardNo</i>, BYTE <i>axis</i>, BYTE <i>nType</i>)</p>
---

### Description:

This function sets the limit switch to be used as the HOME sensor.

### Category:

MODBUS sub\_function; RTC and MP.

### Parameters:

Parameters	Description
<i>hEtm</i> :	TCP/IP connection handle
<i>cardNo</i> :	1 (ET-M8194H supports only one i-8094H module)
<i>axis</i> :	Axis or axes (Please refer to Table 3) The axis can be either X, Y, Z or U (1 or 2 or 4 or 8)
<i>nType</i> :	0: Disable. 1: Use the limit switch as the HOME sensor.

### Return:

0: Success; Others: Fail (Please refer to chapter 2.2)

### Remark:

The Sub\_function code of ETM\_HOME\_LIMIT is 0A 3D.

The Sub\_function code of ETM\_MACRO\_HOME\_LIMIT is 0C 3D.

### MODBUS example:

ETM\_HOME\_LIMIT (*hEtm*, 1, AXIS\_X, 0);

// Do not use the Limit Switch as the HOME sensor.

The MODBUS command is listed as follows:

TID (hex)	PID (hex)	Field Length (hex)	UID (hex)	FC (hex)	St_Addr. (hex)	Word Count (hex)	Byte Count (hex)
00 01	00 00	00 0D	01	10	1F 40	00 03	06
Register[]		Value (hex)		Remarks			
0		0A 3D/0C 3D		Sub_function code			
1		00 01		axis			
2		00 00		nType			

## 6.3 Home Search Mode Setting

<p><b>eRET</b> ETM_SET_HOME_MODE (<b>HANDLE</b> <i>hEtm</i>, <b>BYTE</b> <i>cardNo</i>, <b>BYTE</b> <i>axis</i>, <b>BYTE</b> <i>nStep1</i>, <b>BYTE</b> <i>nStep2</i>, <b>BYTE</b> <i>nStep3</i>, <b>BYTE</b> <i>nStep4</i> , <b>DWORD</b> <i>data</i>)</p> <p>※ <b>eRET</b> ETM_MACRO_SET_HOME_MODE (<b>HANDLE</b> <i>hEtm</i>, <b>BYTE</b> <i>cardNo</i>, <b>BYTE</b> <i>axis</i>, <b>BYTE</b> <i>nStep1</i>, <b>BYTE</b> <i>nStep2</i>, <b>BYTE</b> <i>nStep3</i>, <b>BYTE</b> <i>nStep4</i> , <b>DWORD</b> <i>data</i>)</p>
---

**Description:**

This function sets the automatic home search method and other related parameters.

**Category:**

MODBUS sub\_function; RTC and MP.

**Parameters:**

Paramters	Description
<i>hEtm</i> :	TCP/IP connection handle
<i>cardNo</i> :	1 (ET-M8194H supports only one i-8094H module)
<i>axis</i> :	Axis or axes (Please refer to Table 3) The axis can be either X, Y, Z or U (1 or 2 or 4 or 8)
<i>nStep1</i> :	0: Step 1 will not be executed. 1: Moves in the positive direction. 2: Moves in the negative direction.
<i>nStep2</i> :	0: Step 2 will not be executed. 1: Moves in a positive direction. 2: Moves in a negative direction.
<i>nStep3</i> :	0: Step 3 will not be executed. 1: Moves in a positive direction. 2: Moves in a negative direction.
<i>nStep4</i> :	0: Step 4 will not be executed. 1: Positive correction. 2: Negative correction.
<i>data</i> :	Offset value (0 ~ +2,000,000,000)

**Return:**

0: Success; Others: Fail (Please refer to chapter 2.2)

### The Four Steps Required for Automatic Homing

Step	Action	Speed	Sensor
1	Searching for the Near Home sensor	V	NHOME (IN0)
2	Searching for the HOME sensor	HV	HOME (IN1)
3	Searching for the encoder Z-phasesignal	HV	Z-Phase (IN2)
4	Moves to the specified position	V	

**Remark:**

The Sub\_function code of ETM\_SET\_HOME\_MODE is 0A 3E.

The Sub\_function code of ETM\_MACRO\_SET\_HOME\_MODE is 0C 3E.

**MODBUS example:**

ETM\_SET\_HOME\_MODE (hEtm, 1, 0x1, 2, 2, 1, 1, 3500);

**The MODBUS command is listed as follows:**

TID (hex)	PID (hex)	Field Length (hex)	UID (hex)	FC (hex)	St_Addr. (hex)	Word Count (hex)	Byte Count (hex)
00 01	00 00	00 17	01	10	1F 40	00 08	10
Register[]	Value (hex)	Remarks					
0	0A 3E/0C 3E	<i>Sub_function code</i>					
1	00 01	<i>axis</i>					
2	00 02	<i>nStep1</i>					
3	00 02	<i>nStep2</i>					
4	00 01	<i>nStep3</i>					
5	00 01	<i>nStep4</i>					
6	00 00	<i>MSW of data</i>					
7	0D AC	<i>LSW of data (3500 = 0xDAC)</i>					

## 6.4 Start Automatic Home Search Execution

<b>eRET ETM_HOME_START (HANDLE <i>hEtm</i>, BYTE <i>cardNo</i>, BYTE <i>axis</i>)</b>
<b>※ eRET ETM_MACRO_HOME_START (HANDLE <i>hEtm</i>, BYTE <i>cardNo</i>, BYTE <i>axis</i>)</b>

### Description:

This function starts the automatic home search execution of the assigned axes.

### Category:

MODBUS sub\_function; RTC and MP.

### Parameters:

Paramters	Description
<i>hEtm</i> :	TCP/IP connection handle
<i>cardNo</i> :	1 (ET-M8194H supports only one i-8094H module)
<i>axis</i> :	Axis or axes (Please refer to Table 3) The axis can be either X, Y, Z or U (1 or 2 or 4 or 8)

### Return:

0: Success; Others: Fail (Please refer to chapter 2.2)

### Remark:

The Sub\_function code of ETM\_HOME\_START is 0A 3F.

The Sub\_function code of ETM\_MACRO\_HOME\_START is 0C 3F.

### MODBUS example:

ETM\_HOME\_START (hEtm, 1, AXIS\_X);

//start the automatic homing sequence for the X axis on module 1.

The MODBUS command is listed as follows:

TID (hex)	PID (hex)	Field Length (hex)	UID (hex)	FC (hex)	St_Addr. (hex)	Word Count (hex)	Byte Count (hex)
00 01	00 00	00 0B	01	10	1F 40	00 02	04
Register[]	Value (hex)	Remarks					
0	0A 3F/0C 3F	Sub_function code					
1	00 01	axis (AXIS_X)					

---

## 7 Motion Control Commands

---

### 7.1 Single Axis Motion Control

- Each axis is moving independently.
- The motion of each axis can be started independently.
- Multiple axes can move at the same time.
- Each individual axis can be controlled separately. The number of output pulses, speed, acceleration, etc. can be set for each axis:
- Each axis can receive commands to stop slowly or suddenly to meet the specific requirements.
- Independent axis motion can work with interpolation or synchronous action to perform more complicated and versatile motion.



## 7.1.1 Acceleration/Deceleration Mode Setting

**eRET** ETM\_NORMAL\_SPEED (**HANDLE** *hEtm*, **BYTE** *cardNo*, **BYTE** *axis*, **BYTE** *nMode*)

**※Δ eRET** ETM\_MACRO\_NORMAL\_SPEED (**HANDLE** *hEtm*, **BYTE** *cardNo*, **BYTE** *axis*, **BYTE** *nMode*)

### Description:

This function sets the speed mode.

### Category:

MODBUS sub\_function; RTC, MP and ISR.

### Parameters:

Paramters	Description
<i>hEtm</i> :	TCP/IP connection handle
<i>cardNo</i> :	1 (ET-M8194H supports only one i-8094H module)
<i>axis</i> :	Axis or axes (Please refer to Table 3) The axis can be either X, Y, Z or U (1 or 2 or 4 or 8)
<i>nMode</i> :	0 → Symmetric T-curve (Please set SV, V, A, and AO). 1 → Symmetric S-curve (Please set SV, V, K, and AO). 2 → Asymmetric T-curve (Please set SV, V, A, D, and AO). 3 → Asymmetric S-curve (Please set SV, V, K, L, and AO).

### Return:

0: Success; Others: Fail (Please refer to chapter 2.2)

### Remark:

Please refer the configurations of speed-related parameters.

The Sub\_function code of ETM\_NORMAL\_SPEED is 0A 46.

The Sub\_function code of ETM\_MACRO\_NORMAL\_SPEED is 0C 46.

### MODBUS example:

ETM\_NORMAL\_SPEED (hEtm, 1, AXIS\_XYZU, 0);

//use a symmetric T-curve for all axes on module 1.

The MODBUS command is listed as follows:

TID (hex)	PID (hex)	Field Length (hex)	UID (hex)	FC (hex)	St_Addr. (hex)	Word Count (hex)	Byte Count (hex)
00 01	00 00	00 0D	01	10	1F 40	00 03	06
Register[]		Value (hex)		Remarks			
0		0A 46/0C 46		Sub_function code			
1		00 0F		axis (AXIS_XYZU)			
2		00 00		nMode			

Related example:

```

BYTE cardNo=1; //select module 1.
ETM_SET_MAX_V(hEtm, cardNo, AXIS_XYZU, 20000);
//set the max speed of XYZU axes to be 20K PPS.

//=====
ETM_NORMAL_SPEED(hEtm, cardNo, AXIS_XYZU, 0);
//use a symmetric T-curve for all axes on module 1.
ETM_SET_V(hEtm, cardNo, AXIS_XYZU, 2000);
//set the speed of all axes on module 1 to be 2000 PPS.
ETM_SET_A(hEtm, cardNo, AXIS_XYZU, 1000);
//set the acceleration of all axes on module 1 to be 1000 PPS/Sec.
ETM_SET_SV(hEtm, cardNo, AXIS_XYZU, 2000);
//set the start speed of all axes on module 1 to be 2000 PPS.
ETM_SET_AO(hEtm, cardNo, AXIS_XYZU, 9);
//set the number of remaining offset pulses for all axes to be 9 pulses.
ETM_FIXED_MOVE(hEtm, cardNo, AXIS_XYZU, 10000);
//move all axes on module 1 to be 10000 pulses.

//=====
ETM_NORMAL_SPEED(hEtm, cardNo, AXIS_XYZU,1);
//use a symmetric S-curve for all axes on module 1.
ETM_SET_V(hEtm, cardNo, AXIS_XYZU, 2000);
//set the speed of all axes on module 1 to be 2000 PPS.
ETM_SET_K(hEtm, cardNo, AXIS_XYZU, 500);
//set the acceleration rate of all axes on module 1 to be 500 PPS/sec^2.
ETM_SET_SV(hEtm, cardNo, AXIS_XYZU, 200);
//set the start speed of all axes on module 1 to be 200 PPS.
ETM_SET_AO(hEtm, cardNo, AXIS_XYZU, 9);
//set the number of remaining offset pulses to be 9 pulses for all axes.
ETM_FIXED_MOVE(hEtm, cardNo, AXIS_XYZU, -10000);
//move all axes on module 1 to be 10000 pulses in reverse direction.

//=====
ETM_NORMAL_SPEED(hEtm, cardNo, AXIS_XYZU,2);

```

```

//use an asymmetric T-curve for all axes on module 1.
ETM_SET_V(hEtm, cardNo, AXIS_XYZU, 2000);
//set the speed of all axes on module 1 to be 2000 PPS.
ETM_SET_A(hEtm, cardNo, AXIS_XYZU, 1000 );
//set the acceleration of all axes on module 1 to be 1000 PPS/sec.
ETM_SET_D(hEtm, cardNo, AXIS_XYZU, 500);
//set the deceleration of all axes on module 1 to be 500 PPS.
ETM_SET_SV(hEtm, cardNo, AXIS_XYZU, 200);
//set the start speed of all axes on module 1 to 200 PPS.
ETM_SET_AO(hEtm, cardNo, AXIS_XYZU, 9);
//set the number of remaining offset pulses to be 9 pulses for all axes.
ETM_FIXED_MOVE(hEtm, cardNo, axis, 10000);
//move all axes on module 1 to be 10000 pulses.

//=====
ETM_NORMAL_SPEED(hEtm, cardNo, AXIS_XYZU,3);
//use an asymmetric S-curve for all axes on module 1.
ETM_SET_V(hEtm, cardNo, AXIS_XYZU, 2000);
//set the speed of all axes on module 1 to be 2000 PPS.
ETM_SET_K(hEtm, cardNo, AXIS_XYZU, 500);
//set the acceleration rate of all axes on module 1 to be 500 PPS/sec^2.
ETM_SET_L(hEtm, cardNo, AXIS_XYZU, 300);
//set the deceleration rate of all axes on module 1 to be 300 PPS/sec^2.
ETM_SET_SV(hEtm, cardNo, AXIS_XYZU, 200);
//set the start speed of all axes on module 1 to be 200 PPS.
ETM_SET_AO(hEtm, cardNo, AXIS_XYZU, 9);
//set the number of remaining offset pulses to be 9 pulses for all axes.
ETM_FIXED_MOVE(hEtm, cardNo, AXIS_XYZU, 10000);
//move all axes on module 1 to be 10000 pulses.

```

## 7.1.2 Initial Speed Setting

**eRET ETM\_SET\_SV (HANDLE hEtm, BYTE cardNo, BYTE axis, DWORD data)**

**※Δ eRET ETM\_MACRO\_SET\_SV (HANDLE hEtm, BYTE cardNo, BYTE axis, DWORD data)**

### Description:

This function sets the initial speed for the assigned axes.

### Category:

MODBUS sub\_function; RTC, MP and ISR.

### Parameters:

Paramters	Description
<i>hEtm</i> :	TCP/IP connection handle
<i>cardNo</i> :	1 (ET-M8194H supports only one i-8094H module)
<i>axis</i> :	Axis or axes (Please refer to Table 3) The axis can be either X, Y, Z or U (1 or 2 or 4 or 8)
<i>data</i> :	Initial speed (Please refer to description of ETM_SET_MAX_V for maximm speed) PPS.

### Return:

0: Success; Others: Fail (Please refer to chapter 2.2)

### Remark:

The Sub\_function code of ETM\_SET\_SV is 0A 47.

The Sub\_function code of ETM\_MACRO\_SET\_SV is 0C 47.

### MODBUS example:

ETM\_SET\_SV (hEtm, 1, AXIS\_X, 1000);

//set the starting speed for the X axis on module 1 to 1000 PPS.

The MODBUS command is listed as follows:

TID (hex)	PID (hex)	Field Length (hex)	UID (hex)	FC (hex)	St_Addr. (hex)	Word Count (hex)	Byte Count (hex)
00 01	00 00	00 0F	01	10	1F 40	00 04	08
Register[]		Value (hex)		Remarks			
0		0A 47/0C 47		<i>Sub_function code</i>			
1		00 01		<i>axis (1 = AXIS_X)</i>			
2		00 00		<i>MSW of data</i>			
3		03 E8		<i>LSW of data (1000 = 0x3E8)</i>			

### 7.1.3 Drive Speed Setting

**eRET ETM\_SET\_V (HANDLE hEtm, BYTE cardNo, BYTE axis, DWORD data)**

**※Δ eRET ETM\_MACRO\_SET\_V (HANDLE hEtm, BYTE cardNo, BYTE axis, DWORD data)**

**Description:**

This function sets the desired drive speed for the assigned axes.

**Category:**

MODBUS sub\_function; RTC, MP and ISR.

**Parameters:**

Paramters	Description
<i>hEtm:</i>	TCP/IP connection handle
<i>cardNo:</i>	1 (ET-M8194H supports only one i-8094H module)
<i>axis:</i>	Axis or axes (Please refer to Table 3) The axis can be either X, Y, Z or U (1 or 2 or 4 or 8)
<i>data:</i>	Drive speed (Please refer to description of ETM_SET_MAX_V for maxim speed) PPS.

**Return:**

0: Success; Others: Fail (Please refer to chapter 2.2)

**Remark:**

The Sub\_function code of ETM\_SET\_V is 0A 48.

The Sub\_function code of ETM\_MACRO\_SET\_V is 0C 48.

**MODBUS example:**

ETM\_SET\_V (hEtm, 1, AXIS\_X, 120000L);

*//set the speed for the X axis on module 1 to 120000 PPS.*

**The MODBUS command is listed as follows:**

TID (hex)	PID (hex)	Field Length (hex)	UID (hex)	FC (hex)	St_Addr. (hex)	Word Count (hex)	Byte Count (hex)
00 01	00 00	00 0F	01	10	1F 40	00 04	08
Register[]		Value (hex)		Remarks			
0		0A 48/0C 48		Sub_function code			
1		00 01		axis (1 = AXIS_X)			
2		00 01		MSW of data			
3		D4 C0		LSW of data (120000 = 0x1D4C0)			

## 7.1.4 Acceleration Setting

**eRET ETM\_SET\_A (HANDLE hEtm, BYTE cardNo, BYTE axis, DWORD data)**

**※Δ eRET ETM\_MACRO\_SET\_A (HANDLE hEtm, BYTE cardNo, BYTE axis, DWORD data)**

### Description:

This function sets the acceleration value for the assigned axes.

### Category:

MODBUS sub\_function; RTC, MP and ISR.

### Parameters:

Paramters	Description
<i>hEtm</i> :	TCP/IP connection handle
<i>cardNo</i> :	1 (ET-M8194H supports only one i-8094H module)
<i>axis</i> :	Axis or axes (Please refer to Table 3) The axis can be either X, Y, Z or U (1 or 2 or 4 or 8)
<i>data</i> :	The acceleration value (PPS/sec). This value is related to the maximum speed value defined by ETM_SET_MAX_V() function. The maximum available acceleration value is MAX_V * 125. The minimum acceleration value is MAX_V ÷ 64, and all other acceleration values are the integral multipliers of this value. The practical value for application depends on the capability of the motor drive and motor.

### Return:

0: Success; Others: Fail (Please refer to chapter 2.2)

### Remark:

The Sub\_function code of ETM\_SET\_A is 0A 49.

The Sub\_function code of ETM\_MACRO\_SET\_A is 0C 49.

### MODBUS example:

```
ETM_SET_A (hEtm, 1, AXIS_X, 100000L);
```

```
//set the acceleration value of the X axis on module 1 to 100K PPS/Sec.
```

The MODBUS command is listed as follows:

TID (hex)	PID (hex)	Field Length (hex)	UID (hex)	FC (hex)	St_Addr. (hex)	Word Count (hex)	Byte Count (hex)
00 01	00 00	00 0F	01	10	1F 40	00 04	08
Register[]		Value (hex)		Remarks			
0		0A 49/0C 49		<i>Sub_function code</i>			
1		00 01		<i>axis (1 = AXIS_X)</i>			
2		00 01		<i>MSW of data</i>			
3		86 A0		<i>LSW of data (100000 = 0x186A0)</i>			



## 7.1.5 Deceleration Setting

**eRET ETM\_SET\_D (HANDLE *hEtm*, BYTE *cardNo*, BYTE *axis*, DWORD *data*)**

**※Δ eRET ETM\_MACRO\_SET\_D (HANDLE *hEtm*, BYTE *cardNo*, BYTE *axis*, DWORD *data*)**

### Description:

This function sets the deceleration value for the assigned axes.

### Category:

MODBUS sub\_function; RTC, MP and ISR.

### Parameters:

Paramters	Description
<i>hEtm</i> :	TCP/IP connection handle
<i>cardNo</i> :	1 (ET-M8194H supports only one i-8094H module)
<i>axis</i> :	Axis or axes (Please refer to Table 3) The axis can be either X, Y, Z or U (1 or 2 or 4 or 8)
<i>data</i> :	The deceleration value (PPS/sec). This value is related to the maximum speed value defined by ETM_SET_MAX_V () function. The maximum available deceleration value is MAX_V * 125. The minimum deceleration value is MAX_V ÷ 64, and all other deceleration values are the integral multipliers of this value. The practical value for application depends on the capability of the motor drive and motor.

### Return:

0: Success; Others: Fail (Please refer to chapter 2.2)

### Remark:

The Sub\_function code of ETM\_SET\_D is 0A 4A.

The Sub\_function code of ETM\_MACRO\_SET\_D is 0C 4A.

### MODBUS example:

ETM\_SET\_D (hEtm, 1, AXIS\_X, 100000L);

//set the deceleration value of the X axis on module 1 to 100K PPS/sec.

The MODBUS command is listed as follows:

TID (hex)	PID (hex)	Field Length (hex)	UID (hex)	FC (hex)	St_Addr. (hex)	Word Count (hex)	Byte Count (hex)
00 01	00 00	00 0F	01	10	1F 40	00 04	08
Register[]	Value (hex)	Remarks					
0	0A 4A/0C 4A	<i>Sub_function code</i>					
1	00 01	<i>axis (1 = AXIS_X)</i>					
2	00 01	<i>MSW of data</i>					
3	86 A0	<i>LSW of data (100000 = 0x186A0)</i>					

## 7.1.6 Acceleration Rate Setting

**eRET ETM\_SET\_K (HANDLE hEtm, BYTE cardNo, BYTE axis, DWORD data)**

**※Δ eRET ETM\_MACRO\_SET\_K (HANDLE hEtm, BYTE cardNo, BYTE axis, DWORD data)**

### Description:

The function sets the acceleration rate (i.e., Jerk) value for the assigned axes.

### Category:

MODBUS sub\_function; RTC, MP and ISR.

### Parameters:

Paramters	Description
<i>hEtm</i> :	TCP/IP connection handle
<i>cardNo</i> :	1 (ET-M8194H supports only one i-8094H module)
<i>axis</i> :	Axis or axes (Please refer to Table 3) The axis can be either X, Y, Z or U (1 or 2 or 4 or 8)
<i>data</i> :	The acceleration rate (jerk) value (PPS/ sec <sup>2</sup> ). This value is related to the maximum speed value defined by ETM_SET_MAX_V () function. The minimum acceleration rate is MAX_V * <b>0.0119211</b> ; The maximum acceleration rate value is <b>2,000,000,000</b> .

### Return:

0: Success; Others: Fail (Please refer to chapter 2.2)

### Remark:

The Sub\_function code of ETM\_SET\_K is 0A 4B.

The Sub\_function code of ETM\_MACRO\_SET\_K is 0C 4B.

### MODBUS example:

ETM\_SET\_K (hEtm, 1, AXIS\_X, 10000);

//set the acceleration rate value of the X axis on module 1 to

//1,000\*10 (= 10,000) PPS/Sec^2.

The MODBUS command is listed as follows:

TID (hex)	PID (hex)	Field Length (hex)	UID (hex)	FC (hex)	St_Addr. (hex)	Word Count (hex)	Byte Count (hex)
00 01	00 00	00 0F	01	10	1F 40	00 04	08
Register[]	Value (hex)	Remarks					
0	0A 4B/0C 4B	<i>Sub_function code</i>					
1	00 01	<i>axis (1 = AXIS_X)</i>					
2	00 00	<i>MSW of data</i>					
3	27 10	<i>LSW of data (10000 = 0x2710)</i>					

## 7.1.7 Deceleration Rate Setting

**eRET ETM\_SET\_L (HANDLE hEtm, BYTE cardNo, BYTE axis, DWORD data)**

**※Δ eRET ETM\_MACRO\_SET\_L (HANDLE hEtm, BYTE cardNo, BYTE axis, DWORD data)**

### Description:

The function sets the deceleration rate (i.e., Jerk) value for the assigned axes.

### Category:

MODBUS sub\_function; RTC, MP and ISR.

### Parameters:

Paramters	Description
<i>hEtm:</i>	TCP/IP connection handle
<i>cardNo:</i>	1 (ET-M8194H supports only one i-8094H module)
<i>axis:</i>	Axis or axes (Please refer to Table 3) The axis can be either X, Y, Z or U (1 or 2 or 4 or 8)
<i>data:</i>	The deceleration rate (jerk) value (PPS/ Sec <sup>2</sup> ). This value is related to the maximum speed value defined by ETM_SET_MAX_V () function. The minimum deceleration rate is MAX_V * <b>0.0119211</b> ; The maximum deceleration rate value is <b>2,000,000,000</b>

### Return:

0: Success; Others: Fail (Please refer to chapter 2.2)

### Remark:

The Sub\_function code of ETM\_SET\_L is 0A 4C.

The Sub\_function code of ETM\_MACRO\_SET\_L is 0C 4C.

### MODBUS example:

```
ETM_SET_L (hEtm, 1, AXIS_X, 10000);
```

```
//set the deceleration rate value of the X axis on module 1 to
```

```
//1,000*10 (= 10,000) PPS/Sec^2.
```

The MODBUS command is listed as follows:

TID (hex)	PID (hex)	Field Length (hex)	UID (hex)	FC (hex)	St_Addr. (hex)	Word Count (hex)	Byte Count (hex)
00 01	00 00	00 0F	01	10	1F 40	00 04	08
Register[]		Value (hex)		Remarks			
0		0A 4C/0C 4C		<i>Sub_function code</i>			
1		00 01		<i>axis (1 = AXIS_X)</i>			
2		00 00		<i>MSW of data</i>			
3		27 10		<i>LSW of data (10000 = 0x2710)</i>			

## 7.1.8 Offset Setting

**eRET ETM\_SET\_AO (HANDLE *hEtm*, BYTE *cardNo*, BYTE *axis*, long *data*)**

**※Δ eRET ETM\_MACRO\_SET\_AO (HANDLE *hEtm*, BYTE *cardNo*, BYTE *axis*, long *data*)**

### Description:

This function sets for the assigned axes the offset for deceleration. The default value for offset is 8 after power-on. The offset function can be used for compensation the pulses when the deceleration speed does not reach the initial speed during S-curve fixed pulse driving.

### Category:

MODBUS sub\_function; RTC, MP and ISR.

### Parameters:

Parameters	Description
<i>hEtm</i> :	TCP/IP connection handle
<i>cardNo</i> :	1 (ET-M8194H supports only one i-8094H module)
<i>axis</i> :	Axis or axes (Please refer to Table 3) The axis can be either X, Y, Z or U (1 or 2 or 4 or 8)
<i>data</i> :	The number of remaining offset pulses. (-32,768 ~ +32,767).

### Return:

0: Success; Others: Fail (Please refer to chapter 2.2)

### Remark:

The Sub\_function code of ETM\_SET\_AO is 0A 4D.

The Sub\_function code of ETM\_MACRO\_SET\_AO is 0C 4D.

### MODBUS example:

```
ETM_SET_AO (hEtm, 1, AXIS_X, 200);
```

```
//set the number of remaining offset pulses for the X axis on  
//module 1 to 200 pulses.
```

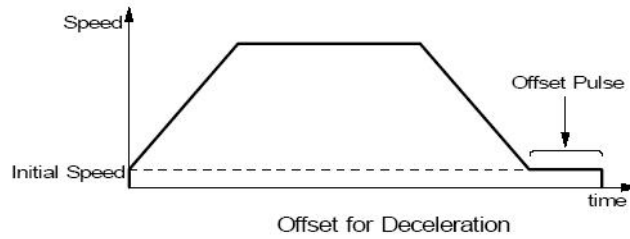

The MODBUS command is listed as follows:

TID (hex)	PID (hex)	Field Length (hex)	UID (hex)	FC (hex)	St_Addr. (hex)	Word Count (hex)	Byte Count (hex)
00 01	00 00	00 0F	01	10	1F 40	00 04	08
Register[]		Value (hex)		Remarks			
0		0A 4D/0C 4D		Sub_function code			
1		00 01		axis (1 = AXIS_X)			
2		00 00		MSW of data			
3		00 C8		LSW of data (200 = 0xC8)			



## 7.1.9 Relative Distance Motion

**eRET** ETM\_FIXED\_MOVE (**HANDLE** *hEtm*, **BYTE** *cardNo*, **BYTE** *axis*, **long** *data*)

※**Δ eRET** ETM\_MACRO\_FIXED\_MOVE (**HANDLE** *hEtm*, **BYTE** *cardNo*, **BYTE** *axis*, **long** *data*)

### Description:

Command a point-to-point motion for fixed position movement.

### Category:

MODBUS sub\_function; RTC, MP and ISR.

### Parameters:

Paramters	Description
<i>hEtm</i> :	TCP/IP connection handle
<i>cardNo</i> :	1 (ET-M8194H supports only one i-8094H module)
<i>axis</i> :	Axis or axes (Please refer to Table 3) The axis can be either X, Y, Z or U (1 or 2 or 4 or 8)
<i>data</i> :	Pulses (-2,000,000,000 ~ +2,000,000,000).

### Return:

0: Success; Others: Fail (Please refer to chapter 2.2)

### Remark:

The Sub\_function code of ETM\_FIXED\_MOVE is 0A 4E.

The Sub\_function code of ETM\_MACRO\_FIXED\_MOVE is 0C 4E.

### MODBUS example:

```
ETM_FIXED_MOVE (hEtm, cardNo, AXIS_XYZU, 10000);  
// AXIS_XYZU move 10000 Pulses
```

The MODBUS command is listed as follows:

TID (hex)	PID (hex)	Field Length (hex)	UID (hex)	FC (hex)	St_Addr. (hex)	Word Count (hex)	Byte Count (hex)
00 01	00 00	00 0F	01	10	1F 40	00 04	08
Register[]		Value (hex)		Remarks			
0		0A 4E/0C 4E		<i>Sub_function code</i>			
1		00 0F		<i>axis (0xF = AXIS_XYZU)</i>			
2		00 00		<i>MSW of data</i>			
3		27 10		<i>LSW of data (10000 = 0x2710)</i>			

Related example:

```

BYTE cardNo=1; //select module 1
ETM_SET_MAX_V(hEtm, cardNo, AXIS_XYZU, 20000);
//set the max. velocity of all axes on module 1 to be 20K PPS
ETM_NORMAL_SPEED(hEtm, cardNo, AXIS_XYZU, 0);
//set the speed profile of all axes on module 1 to be symmetric T-curve
ETM_SET_V(hEtm, cardNo, AXIS_XYZU, 2000);
//set the speed of all axes on module 1 to be 2000 PPS
ETM_SET_A(hEtm, cardNo, AXIS_XYZU,1000);
//set the acceleration value of all axes on module 1 to be 1000 PPS/S
ETM_SET_SV(hEtm, cardNo, AXIS_XYZU, 2000);
//set the start velocity of all axes on module 1 to be 2000 PPS
ETM_SET_AO(hEtm, cardNo, AXIS_XYZU, 9);
//set the remaining offset pulses to be 9 PPS
ETM_FIXED_MOVE(hEtm, cardNo, AXIS_XYZU, 10000);
// move 10000 Pulses for each axis on module 1

```

## 7.1.10 Change Target Position on the Fly

**eRET ETM\_SET\_PULSE (HANDLE *hEtm*, BYTE *cardNo*, BYTE *axis*,  
DWORD *data*)**

**※Δ eRET ETM\_MACRO\_SET\_PULSE (HANDLE *hEtm*, BYTE *cardNo*, BYTE  
*axis*, DWORD *data*)**

### Description:

This command supports the change of target position on the fly for each axis (but does not support change of the direction during driving).

### Category:

MODBUS sub\_function; RTC, MP and ISR.

### Parameters:

Paramters	Description
<i>hEtm</i> :	TCP/IP connection handle
<i>cardNo</i> :	1 (ET-M8194H supports only one i-8094H module)
<i>axis</i> :	Axis or axes (Please refer to Table 3) The axis can be either X, Y, Z or U (1 or 2 or 4 or 8)
<i>data</i> :	Pulses (0 ~ +2,000,000,000).

### Return:

0: Success; Others: Fail (Please refer to chapter 2.2)

### Remark:

The Sub\_function code of ETM\_SET\_PULSE is 0A 4F.

The Sub\_function code of ETM\_MACRO\_SET\_PULSE is 0C 4F.

### MODBUS example:

ETM\_SET\_PULSE (hEtm, cardNo, AXIS\_XYZU, 9000);

//Change the total pulses to 9000 pulses during fixed pulse moving.

The MODBUS command is listed as follows:

TID (hex)	PID (hex)	Field Length (hex)	UID (hex)	FC (hex)	St_Addr. (hex)	Word Count (hex)	Byte Count (hex)
00 01	00 00	00 0F	01	10	1F 40	00 04	08
Register[]		Value (hex)		Remarks			
0		0A 4F/0C 4F		Sub_function code			
1		00 0F		axis (0xF = AXIS_XYZU)			
2		00 00		MSW of data			
3		23 28		LSW of data (9000 = 0x2328)			

Related example:

```

BYTE cardNo=1; //select module 1
ETM_SET_MAX_V(hEtm, cardNo, AXIS_XYZU, 20000);
//set the max velocity of all axes on module 1 to be 20K PPS
ETM_NORMAL_SPEED(hEtm, cardNo, AXIS_XYZU, 0);
//set the speed profile of all axes on module 1 to be symmetric T-curve
ETM_SET_V(hEtm, cardNo, AXIS_XYZU, 2000);
//set the speed of all axes on module 1 to be 2000 PPS
ETM_SET_A(hEtm, cardNo, AXIS_XYZU,1000);
//set the acceleration value of all axes on module 1 to be 1000 PPS/S
ETM_SET_SV(hEtm, cardNo, AXIS_XYZU, 2000);
//set the start velocity of all axes on module 1 to be 2000 PPS
ETM_SET_AO(hEtm, cardNo, AXIS_XYZU, 9);
//set the remaining offset pulses to be 9 PPS
ETM_FIXED_MOVE(hEtm, cardNo, AXIS_XYZU, 10000);
// move 10000 Pulses for each axis on module 1
ETM_SET_PULSE(hEtm, cardNo, AXIS_XYZU, 9000);
//Set pulse as 9000 Pulse.

```

## 7.1.11 Move to Absoulte Position

**eRET ETM\_ABS\_FIXED\_MOVE (HANDLE *hEtm*, BYTE *cardNo*, BYTE *axis*, long *data*)**

**※Δ eRET ETM\_ABS\_MACRO\_FIXED\_MOVE (HANDLE *hEtm*, BYTE *cardNo*, BYTE *axis*, long *data*)**

### Description:

This function commands a controlled point-to-point motion to a specified absolute position.

### Category:

MODBUS sub\_function; RTC, MP and ISR.

### Parameters:

Paramters	Description
<i>hEtm</i> :	TCP/IP connection handle
<i>cardNo</i> :	1 (ET-M8194H supports only one i-8094H module)
<i>axis</i> :	Axis or axes (Please refer to Table 3) The axis can be either X, Y, Z or U (1 or 2 or 4 or 8)
<i>data</i> :	Absolute position (-2,000,000,000 ~ +2,000,000,000).

### Return:

0: Success; Others: Fail (Please refer to chapter 2.2)

### Remark:

The Sub\_function code of ETM\_ABS\_FIXED\_MOVE is 0x0AF6.  
The Sub\_function code of ETM\_ABS\_MACRO\_FIXED\_MOVE is 0x0CF6

### MODBUS example:

```
ETM_ABS_FIXED_MOVE (hEtm, cardNo, AXIS_XYZU, 10000);  
// AXIS_XYZU moves from the current position to the logic position 10000  
in a straight line
```

The MODBUS command is listed as follows:

TID (hex)	PID (hex)	Field Length (hex)	UID (hex)	FC (hex)	St_Addr. (hex)	Word Count (hex)	Byte Count (hex)
00 01	00 00	00 0F	01	10	1F 40	00 04	08
Register[]		Value (hex)		Remarks			
0		0A F6/0C F6		<i>Sub_function code</i>			
1		00 0F		<i>axis (0xF = AXIS_XYZU)</i>			
2		00 00		<i>MSW of data</i>			
3		27 10		<i>LSW of data (10000 = 0x2710)</i>			

Related example:

```

BYTE cardNo=1; //select module 1
ETM_SET_MAX_V(hEtm, cardNo, AXIS_XYZU, 20000);
//set the max. velocity of all axes on module 1 to be 20K PPS
ETM_NORMAL_SPEED(hEtm, cardNo, AXIS_XYZU, 0);
//set the speed profile of all axes on module 1 to be symmetric T-curve
ETM_SET_V(hEtm, cardNo, AXIS_XYZU, 2000);
//set the speed of all axes on module 1 to be 2000 PPS
ETM_SET_A(hEtm, cardNo, AXIS_XYZU,1000);
//set the acceleration value of all axes on module 1 to be 1000 PPS/S
ETM_SET_SV(hEtm, cardNo, AXIS_XYZU, 2000);
//set the start velocity of all axes on module 1 to be 2000 PPS
ETM_SET_AO(hEtm, cardNo, AXIS_XYZU, 9);
//set the remaining offset pulses to be 9 PPS
ETM_ABS_FIXED_MOVE(hEtm, cardNo, AXIS_XYZU, 10000);
// All four axis are moving to the absolute position 10000

```

## 7.1.12 Continue Pulse Driving Output

**eRET ETM\_CONTINUE\_MOVE (HANDLE hEtm, BYTE cardNo, BYTE axis, long data)**

**※Δ eRET ETM\_MACRO\_CONTINUE\_MOVE (HANDLE hEtm, BYTE cardNo, BYTE axis, long data)**

### Description:

When the Continuous Pulse Driving is performed the ET-M8194H will drive pulse output at a specified speed until a stop command or external stop signal is activated. The drive speed can be changed freely during continuous pulse driving.

### Category:

MODBUS sub\_function; RTC, MP and ISR.

### Parameters:

Parameters	Description
<i>hEtm</i> :	TCP/IP connection handle
<i>cardNo</i> :	1 (ET-M8194H supports only one i-8094H module)
<i>axis</i> :	Axis or axes (Please refer to Table 3) The axis can be either X, Y, Z or U (1 or 2 or 4 or 8)
<i>data</i> :	The specified speed (positive value for CW motion; negative value for CCW motion)

### Return:

0: Success; Others: Fail (Please refer to chapter 2.2)  
Use the ETM\_GET\_ERROR\_CODE() function to identify the errors.

### Remark:

The Sub\_function code of ETM\_CONTINUE\_MOVE is 0A 50.  
The Sub\_function code of ETM\_MACRO\_CONTINUE\_MOVE is 0C 50.

### MODBUS example:

```
ETM_CONTINUE_MOVE (hEtm, cardNo, AXIS_XYZU, 1000);  
//continue to move at the speed of 1K PPS
```

The MODBUS command is listed as follows:

TID (hex)	PID (hex)	Field Length (hex)	UID (hex)	FC (hex)	St_Addr. (hex)	Word Count (hex)	Byte Count (hex)
00 01	00 00	00 0F	01	10	1F 40	00 04	08
Register[]		Value (hex)		Remarks			
0		0A 50/0C 50		Sub_function code			
1		00 0F		axis (0xF = AXIS_XYZU)			
2		00 00		MSW of data			
3		03 E8		LSW of data (1000 = 0x3E8)			

Related example:

```

BYTE cardNo=1; //select module 1
ETM_SET_MAX_V(hEtm, cardNo, AXIS_XYZU, 20000);
//set the maximum speed of all axes on module 1 to 20K PPS.
ETM_NORMAL_SPEED(hEtm, cardNo, AXIS_XYZU, 0);
//set the speed profile for all axes as a symmetric T-curve.
ETM_SET_V(hEtm, cardNo, AXIS_XYZU, 2000);
//set the speed of all axes on module 1 to 2000 PPS.
ETM_SET_A(hEtm, cardNo, AXIS_XYZU,1000);
//set the acceleration value of all axes to 1000 PPS/S.
ETM_SET_SV(hEtm, cardNo, AXIS_XYZU, 2000);
//set the start velocity of all axes to 2000 PPS
ETM_CONTINUE_MOVE(hEtm, cardNo, AXIS_XYZU, 1000);
//move all axes on module 1 at a speed of 1000 PPS.

```



## 7.2 Interpolation Commands

### 7.2.1 Interpolation Axes Assignment

```
eRET ETM_AXIS_ASSIGN (HANDLE hEtm, BYTE cardNo, BYTE axis1,  
BYTE axis2, BYTE axis3)
```

```
※Δ eRET ETM_MACRO_AXIS_ASSIGN (HANDLE hEtm, BYTE cardNo,  
BYTE axis1, BYTE axis2, BYTE axis3)
```

#### Description:

This function assigns the axes to be used for interpolation. Either two or three axes can be assigned by using this function. Interpolation commands will refer to the assigned axes to construct a working coordinate system. The X axis does not necessarily have to be the first axis. However, it is easier to use the X axis as the first axis, the Y axis as the second axis, and the Z axis as the third axis.

#### Category:

MODBUS sub\_function; RTC, MP and ISR.

#### Parameters:

Paramters	Description
<i>hEtm</i> :	TCP/IP connection handle
<i>cardNo</i> :	1 (ET-M8194H supports only one i-8094H module)
<i>axis1</i> :	Axis or axes (Please refer to Table 3) The axis can be either X, Y, Z or U (1 or 2 or 4 or 8)
<i>axis2</i> :	The second axis; can be either X, Y, Z, or U (1 or 2 or 4 or 8).
<i>axis3</i> :	The third axis; can be either X, Y, Z, or U (1 or 2 or 4 or 8). Without 3rd axis the value is 0.

#### Return:

0: Success; Others: Fail (Please refer to chapter 2.2)

#### Remark:

The Sub\_function code of ETM\_AXIS\_ASSIGN is 0A 5A.

The Sub\_function code of ETM\_MACRO\_AXIS\_ASSIGN is 0C 5A.

#### MODBUS example:

```
ETM_AXIS_ASSIGN (hEtm, 1, AXIS_X, AXIS_Y, 0);  
//set the X axis of module 1 as the first axis and the Y axis as the second  
//axis.
```

The MODBUS command is listed as follows:

TID (hex)	PID (hex)	Field Length (hex)	UID (hex)	FC (hex)	St_Addr. (hex)	Word Count (hex)	Byte Count (hex)
00 01	00 00	00 0F	01	10	1F 40	00 04	08
Register[]		Value (hex)		Remarks			
0		0A 5A/0C 5A		<i>Sub_function code</i>			
1		00 01		<i>axis1 (axis1 = AXIS_X)</i>			
2		00 02		<i>axis2 (axis1 = AXIS_Y)</i>			
3		00 00		<i>Axis3 (not defined)</i>			

## 7.2.2 Speed and Acc/Dec Mode Setting

**eRET ETM\_VECTOR\_SPEED (HANDLE *hEtm*, BYTE *cardNo*, BYTE *nMode*)**

**※Δ eRET ETM\_MACRO\_VECTOR\_SPEED (HANDLE *hEtm*, BYTE *cardNo*, BYTE *nMode*)**

### Description:

This function sets the acceleration and deceleration profile for the interpolation axis.

### Category:

MODBUS sub\_function; RTC, MP and ISR.

### Parameters:

Parameters	Description
<i>hEtm</i> :	TCP/IP connection handle
<i>cardNo</i> :	1 (ET-M8194H supports only one i-8094H module)
<i>nMode</i> :	0 → 2-axis linear or circular motion at a constant vector speed (Set VV and VSV; and VV=VSV). 1 → 2-axis linear motion using a symmetric T-curve velocity profile (set VSV, VV, VA, and VAO) 2 → 2-axis linear motion using a symmetric S-curve velocity profile (set VSV, VV, VK, and VAO) 3 → 2-axis linear motion using an asymmetric T-curve velocity profile (set VSV, VV, VA, VD, and VAO) 4 → 2-axis linear motion using an asymmetric S-curve velocity profile (set VSV, VV, VK, VL, and VAO) 5 → 2-axis circular motion using a symmetric T-curve velocity profile (set VSV, VV, VA, and VAO) 6 → 2-axis circular motion using an asymmetric T-curve velocity profile (set VSV, VV, VA, VD, and VAO) 7 → 3-axis linear motion at a constant vector speed set VV and VSV; and VV=VSV) 8 → 3-axis linear motion at using a symmetric T-curve velocity profile (set VSV, VV, VA, and VAO) 9 → 3-axis linear motion using a symmetric S-curve velocity profile (set VSV, VV, VK, and VAO) 10 → 3-axis linear motion using an asymmetric T-curve velocity profile (set VSV, VV, VA, VD, and VAO) 11 → 3-axis linear motion using an asymmetric S-curve velocity profile (set VSV, VV, VK, VL, and VAO)

### Return:

0: Success; Others: Fail (Please refer to chapter 2.2)

**Remark:**

Please refer the configurations of speed-related parameters.  
The Sub\_function code of ETM\_VECTOR\_SPEED is 0A 5B.  
The Sub\_function code of ETM\_MACRO\_VECTOR\_SPEED is 0C 5B.

**MODBUS example:**

```
ETM_VECTOR_SPEED (hEtm, cardNo, 0);  
//set the module to perform 2-axis linear or circular motion  
//at a constant vector speed.
```

The MODBUS command is listed as follows:

TID (hex)	PID (hex)	Field Length (hex)	UID (hex)	FC (hex)	St_Addr. (hex)	Word Count (hex)	Byte Count (hex)
00 01	00 00	00 0B	01	10	1F 40	00 02	04
Register[]		Value (hex)		Remarks			
0		0A 5B/0C 5B		Sub_function code			
1		00 00		nMode			

**Related example:**

```
BYTE cardNo=1; //select module 1.  
ETM_SET_MAX_V(hEtm, cardNo, AXIS_XYZU, 20000);  
//set the maximum speed of all axes to 20K PPS.  
  
//=====  
ETM_AXIS_ASSIGN(hEtm, cardNo, AXIS_X, AXIS_Y, 0);  
//set the X axis as the first axis and the Y axis as the second axis.  
ETM_VECTOR_SPEED(hEtm, cardNo, 0);  
//set module 1 to perform 2-axis linear or circular motion  
ETM_SET_VV(hEtm, cardNo, 1000);  
//set the vector speed to 1000 PPS.  
ETM_LINE_2D(hEtm, cardNo, 12000, 10000);  
//execute the 2-axis linear interpolation motion.  
  
//=====  
ETM_AXIS_ASSIGN(hEtm, cardNo, AXIS_X, AXIS_Y, 0);  
//set the X axis as the first axis and the Y axis as the second axis.  
ETM_VECTOR_SPEED(hEtm, cardNo, 1);  
//set module 1 to perform 2-axis linear motion using a symmetric  
//T-curve velocity profile (VSV \ VV \ VA \ VAO).  
ETM_SET_VSV(hEtm, cardNo, 500); //set the starting vector speed to 500  
PPS.  
ETM_SET_VV(hEtm, cardNo, 2000); //set the vector speed to 2000 PPS.  
ETM_SET_VA(hEtm, cardNo, 1000);
```

```

//set the vector acceleration to 1000 PPS/sec.
ETM_LINE_2D(hEtm, cardNo, 20000, 10000);
//execute the 2-axis linear interpolation motion.

//=====
ETM_AXIS_ASSIGN(hEtm, cardNo, AXIS_X, AXIS_Y, 0);
//set the X axis as the first axis and the Y axis as the second axis.
ETM_VECTOR_SPEED(hEtm, cardNo, 2);
//2-axis linear motion using a symmetric S-curve velocity profile(VSV 、VV 、
//VK 、AO).
ETM_SET_VSV(hEtm, cardNo, 200); //set the starting vector speed to 200
PPS.
ETM_SET_VV(hEtm, cardNo, 2000); //set the vector speed to 2000 PPS.
ETM_SET_VK(hEtm, cardNo, 500); //set the acceleration rate to 500
PPS/Sec.
ETM_SET_VAO(hEtm, cardNo, 20);
//set the value of remaining offset pulses to 20.
ETM_LINE_2D(hEtm, cardNo, 10000, 10000);
//execute the 2-axis linear interpolation motion.

//=====
ETM_AXIS_ASSIGN(hEtm, cardNo, AXIS_X, AXIS_Y, 0);
//set the X axis as the first axis and the Y axis as the second axis.
ETM_VECTOR_SPEED(hEtm, cardNo, 3);
//2-axis linear motion using an asymmetric T-curve velocity profile(VSV 、
//VV 、VA 、VD 、VAO).
ETM_SET_VSV(hEtm, cardNo, 100); //set the start vector speed to 100 PPS.
ETM_SET_VV(hEtm, cardNo, 2000); //set the vector speed to 2000 PPS.
ETM_SET_VA(hEtm, cardNo, 1000);
//set the vector acceleration to 1000 PPS/sec.
ETM_SET_VD(hEtm, cardNo, 500); //set the vector deceleration to 500
PPS/sec.
ETM_SET_VAO(hEtm, cardNo, 20);
//set the value of remaining offset pulses to 20.
ETM_LINE_2D(hEtm, cardNo, 10000, 5000);
//execute the 2-axis linear interpolation motion.

//=====
long fp1=4000;
long fp2=10000;
unsigned short sv=200;
unsigned short v=2000;
ETM_SET_MAX_V(hEtm, cardNo, AXIS_XYZU, 8000);
ETM_AXIS_ASSIGN(hEtm, cardNo, AXIS_X, AXIS_Y, 0);
//set the X axis as the first axis and the Y axis as the second axis.
ETM_VECTOR_SPEED(hEtm, cardNo, 4);

```

```

//2-axis linear motion using an asymmetric S-curve velocity profile(VSV \
//VV \ VK \ VL \ VAO).
ETM_SET_VSV(hEtm, cardNo, sv); //set the starting velocity to sv PPS.
ETM_SET_VV(hEtm, cardNo, v); //set the vector speed to v PPS.
ETM_SET_VK(hEtm, cardNo, 500); //set the acceleration rate to 500
PPS/Sec^2.
ETM_SET_VL(hEtm, cardNo, 300); //set the deceleration rate to 300
PPS/Sec^2.
ETM_SET_VAO(hEtm, cardNo, 20);
//set the value of remaining offset pulses to 20.
ETM_LINE_2D(hEtm, cardNo, fp1, fp2); //execute the 2-axis linear motion.

//=====
long fp1=11000;
long fp2=9000;
long c1=10000;
long c2=0;
unsigned short sv=100;
unsigned short v=3000;
unsigned long a=5000;
ETM_SET_MAX_V(hEtm, cardNo, AXIS_XYZU, 8000);
ETM_AXIS_ASSIGN(hEtm, cardNo, AXIS_X, AXIS_Y, 0);
//set the X axis as the first axis and the Y axis as the second axis.
ETM_VECTOR_SPEED(hEtm, cardNo, 5);
//2-axis circular motion using a symmetric T-curve velocity profile(VSV \
//VV \ VA \ VAO).
ETM_SET_VSV(hEtm, cardNo, sv); //set the starting vector speed to sv PPS.
ETM_SET_VV(hEtm, cardNo, v); //set vector speed to v PPS.
ETM_SET_VA(hEtm, cardNo, a); //set the vector acceleration to a PPS/sec.
ETM_SET_VAO(hEtm, cardNo, 0);
//set the value of remaining offset pulses to 0 Pulse.
ETM_ARC_CW(hEtm, cardNo, c1,c2, fp1, fp2);
//execute the 2-axis CW circular motion.

//=====
long c1=300;
long c2=0;
unsigned short sv=100;
unsigned short v=3000;
unsigned long a=125;
unsigned long d=12;
ETM_SET_MAX_V(hEtm, cardNo, AXIS_XYZU, 8000);
ETM_AXIS_ASSIGN(hEtm, cardNo, AXIS_X, AXIS_Y, 0);
//set the X axis as the first axis and the Y axis as the second axis.
ETM_VECTOR_SPEED(hEtm, cardNo, 6);
//2-axis circular motion using an asymmetric T-curve velocity

```

```

//profile(VSV 、 VV 、 VA 、 VD 、 VAO).
ETM_SET_VSV(hEtm, cardNo, sv); //set the starting vector speed to sv PPS.
ETM_SET_VV(hEtm, cardNo, v); //set vector speed to v PPS.
ETM_SET_VA(hEtm, cardNo, a); //set acceleration to a PPS/Sec.
ETM_SET_VD(hEtm, cardNo, d); //set the deceleration to d PPS/Sec.
ETM_SET_VAO(hEtm, cardNo, 0); //set the value of remaining offset pulses
to 0.
ETM_CIRCLE_CW(hEtm, cardNo, c1, c2);
//execute the 2-axis CW circular motion.

//=====
ETM_AXIS_ASSIGN(hEtm, cardNo, AXIS_X, AXIS_Y, AXIS_Z);
// set axis1 as the X axis, axis2 as the Y axis, and axis3 as the Z axis.
ETM_VECTOR_SPEED(hEtm, cardNo, 7);
//3-axis linear motion at a constant vector speed (VSV=VV).
ETM_SET_VSV(hEtm, cardNo, 1000); //set the start speed to 1000 PPS.
ETM_SET_VV(hEtm, cardNo, 1000); //set the constant speed to 1000 PPS.
ETM_LINE_3D(hEtm, cardNo, 10000, 10000,10000);
//execute the 3-axis linear motion.

//=====
ETM_AXIS_ASSIGN(hEtm, cardNo, AXIS_X, AXIS_Y, AXIS_Z);
// set axis1 as the X axis, axis2 as the Y axis, and axis3 as the Z-axis.
ETM_VECTOR_SPEED(hEtm, cardNo, 8);
//3-axis linear motion using a symmetric T-curve velocity profile(VSV 、 VV 、
//VA 、 VAO).
ETM_SET_VSV(hEtm, cardNo, 100); //set the starting speed to 100 PPS.
ETM_SET_VV(hEtm, cardNo, 3000); //set the vector speed to 3000 PPS.
ETM_SET_VA(hEtm, cardNo, 500); //set the vector acceleration to 500
PPS/Sec.
ETM_SET_VAO(hEtm, cardNo, 20);
//set the value of remaining offset pulses to 20.
ETM_LINE_3D(hEtm, cardNo, 10000, 1000,20000);
//execute the 3-axis linear motion

//=====
ETM_AXIS_ASSIGN(hEtm, cardNo, AXIS_X, AXIS_Y, AXIS_Z);
// set the axis1 as the X axis, axis2 as the Y axis, and axis3 as the Z axis.
ETM_VECTOR_SPEED(hEtm, cardNo, 9);
//3-axis linear motion using a symmetric S-curve velocity profile(VSV 、 VV 、
//VK 、 VAO).
ETM_SET_VSV(hEtm, cardNo, 100); //set the starting speed to 100 PPS.
ETM_SET_VV(hEtm, cardNo, 3000); //set the vector speed to 3000 PPS.
ETM_SET_VK(hEtm, cardNo, 500);
//set the vector acceleration rate to 500 PPS/sec^2.
ETM_SET_VAO(hEtm, cardNo, 20);

```

```

//set the value of remaining offset pulses to 20.
ETM_LINE_3D(hEtm, cardNo, 10000, 1000,1000);
//execute the 3-axis linear motion.

//=====
ETM_AXIS_ASSIGN(hEtm, cardNo, AXIS_X, AXIS_Y, AXIS_Z);
// set the axis1 as the X axis, axis2 as the Y axis, and axis3 as the Z axis.
ETM_VECTOR_SPEED(hEtm, cardNo, 10);
//set the module 1 to perform 3-axis linear motion
//using an asymmetric T-curve speed profile(VSV \ VV \ VA \ VD \ VAO).
ETM_SET_VSV(hEtm,cardNo, 100); //set the starting speed to 100 PPS.
ETM_SET_VV(hEtm,cardNo, 2000); //set the vector speed as 2000 PPS.
ETM_SET_VA(hEtm, cardNo, 1000);
//set the vector acceleration to 1000 PPS/sec.
ETM_SET_VD(hEtm, cardNo, 500); //set the vector deceleration to 500
PPS/sec.
ETM_SET_VAO(hEtm, cardNo, 20);
//set the value of remaining offset pulses to 20.
ETM_LINE_3D(hEtm, cardNo, 10000, 1000,1000);
//execute the 3-axis linear motion.

//=====
long fp1=4000;
long fp2=10000;
long fp3=20000;
unsigned short sv=200;
unsigned short v=2000;
ETM_SET_MAX_V(hEtm, cardNo, AXIS_XYZU, 8000);
ETM_AXIS_ASSIGN(hEtm, cardNo, AXIS_X, AXIS_Y, AXIS_Z);
// set axis1 as the X axis, axis2 as the Y axis, and axis3 as the Z axis.
ETM_VECTOR_SPEED(hEtm, cardNo, 11);
//3-axis linear motion using an asymmetric S-curve velocity profile(VSV \
//VV \ VK \ VL \ VAO).
ETM_SET_VSV(hEtm, cardNo, sv); //set the starting speed to sv PPS.
ETM_SET_VV(hEtm, cardNo, v); //set the vector speed to v PPS.
ETM_SET_VK(hEtm, cardNo, 500);
//set the vector acceleration rate to 500 PPS/sec^2.
ETM_SET_VL(hEtm, cardNo, 300);
//set the vector deceleration rate to 300 PPS/sec^2.
ETM_SET_VAO(hEtm, cardNo, 20);
//set the value of remaining offset pulses to 20.
ETM_LINE_3D(hEtm, cardNo, fp1, fp2, fp3);
//execute the 3-axis linear motion.

```



### 7.2.3 Vector Initial Speed Setting

**eRET ETM\_SET\_VSV (HANDLE *hEtm*, BYTE *cardNo*, DWORD *data*)**

**※Δ eRET ETM\_MACRO\_SET\_VSV (HANDLE *hEtm*, BYTE *cardNo*, DWORD *data*)**

**Description:**

This function sets the starting speed of the main axis (axis 1) for the interpolation motion.

**Category:**

MODBUS sub\_function; RTC, MP and ISR.

**Parameters:**

Paramters	Description
<i>hEtm</i> :	TCP/IP connection handle
<i>cardNo</i> :	1 (ET-M8194H supports only one i-8094H module)
<i>data</i> :	The vector starting speed value (in PPS) (For maximum value please refers to description of ETM_SET_MAX_V).

**Return:**

0: Success; Others: Fail (Please refer to chapter 2.2)

**Remark:**

The Sub\_function code of ETM\_SET\_VSV is 0A 5C.

The Sub\_function code of ETM\_MACRO\_SET\_VSV is 0C 5C.

**MODBUS example:**

```
ETM_SET_VSV (hEtm, 1, 1000);
//set the starting speed of the axis 1 for the interpolation motion
//on module 1 to 1000 PPS.
```

The MODBUS command is listed as follows:

TID (hex)	PID (hex)	Field Length (hex)	UID (hex)	FC (hex)	St_Addr. (hex)	Word Count (hex)	Byte Count (hex)
00 01	00 00	00 0D	01	10	1F 40	00 03	06
Register[]	Value (hex)	Remarks					
0	0A 5C/0C 5C	Sub_function code					
1	00 00	MSW of data					
2	03 E8	LSW of data (1000 = 0x3E8)					

## 7.2.4 Vector Speed Setting

**eRET ETM\_SET\_VV (HANDLE hEtm, BYTE cardNo, DWORD data)**

**※Δ eRET ETM\_MACRO\_SET\_VV (HANDLE hEtm, BYTE cardNo, DWORD data)**

### Description:

This function sets the vector speed of the interpolation motion. Users do not need to assign any axes on this function. The speed setting will take effect on the current working coordinate system which is defined by the ETM\_AXIS\_ASSIGN() function.

### Category:

MODBUS sub\_function; RTC, MP and ISR.

### Parameters:

Paramters	Description
<i>hEtm</i> :	TCP/IP connection handle
<i>cardNo</i> :	1 (ET-M8194H supports only one i-8094H module)
<i>data</i> :	The vector speed value (in PPS) (For maximum value please refers to description of ETM_SET_MAX_V).

### Return:

0: Success; Others: Fail (Please refer to chapter 2.2)

### Remark:

The Sub\_function code of ETM\_SET\_VV is 0A 5D.

The Sub\_function code of ETM\_MACRO\_SET\_VV is 0C 5D.

### MODBUS example:

ETM\_SET\_VV (hEtm, 1, 120000L);

*//set the vector speed of the interpolation on module 1 to 120000 PPS.*

The MODBUS command is listed as follows:

TID (hex)	PID (hex)	Field Length (hex)	UID (hex)	FC (hex)	St_Addr. (hex)	Word Count (hex)	Byte Count (hex)
00 01	00 00	00 0D	01	10	1F 40	00 03	06
Register[]	Value (hex)	Remarks					
0	0A 5D/0C 5D	Sub_function code					
1	00 01	MSW of data					
2	D4 C0	LSW of data (120000 = 0x1D4C0)					

## 7.2.5 Vector Acceleration Setting

**eRET ETM\_SET\_VA (HANDLE hEtm, BYTE cardNo, DWORD data)**

**※Δ eRET ETM\_MACRO\_SET\_VA (HANDLE hEtm, BYTE cardNo, DWORD data)**

### Description:

This function sets the vector acceleration of the interpolation motion. Users do not need to assign any axes on this function. The speed setting will take effect on the current working coordinate system which is defined by the ETM\_AXIS\_ASSIGN() function.

### Category:

MODBUS sub\_function; RTC, MP and ISR.

### Parameters:

Paramters	Description
<i>hEtm:</i>	TCP/IP connection handle
<i>cardNo:</i>	1 (ET-M8194H supports only one i-8094H module)
<i>data:</i>	The vector acceleration value (in PPS/sec). This value is related to the maximum speed value defined by ETM_SET_MAX_V () function. The maximum available acceleration value is MAX_V * 125. The minimum acceleration value is MAX_V ÷ 64, and all other acceleration values are the integral multipliers of this value. The practical value for application depends on the capability of the motor drive and motor.

### Return:

0: Success; Others: Fail (Please refer to chapter 2.2)

### Remark:

The Sub\_function code of ETM\_SET\_VA is 0A 5E.

The Sub\_function code of ETM\_MACRO\_SET\_VA is 0C 5E.

### MODBUS example:

```
ETM_SET_VA (hEtm, 1, 100000L);
```

```
//set the vector acceleration of the interpolation motion
```

```
//on module 1 to 100K PPS/sec.
```

The MODBUS command is listed as follows:

TID (hex)	PID (hex)	Field Length (hex)	UID (hex)	FC (hex)	St_Addr. (hex)	Word Count (hex)	Byte Count (hex)
00 01	00 00	00 0D	01	10	1F 40	00 03	06
Register[]		Value (hex)		Remarks			
0		0A 5E/0C 5E		Sub_function code			
1		00 01		MSW of data			
2		86 A0		LSW of data (100000 = 0x186A0)			

## 7.2.6 Vector Deceleration Setting

**eRET ETM\_SET\_VD (HANDLE *hEtm*, BYTE *cardNo*, DWORD *data*)**

**※Δ eRET ETM\_MACRO\_SET\_VD (HANDLE *hEtm*, BYTE *cardNo*, DWORD *data*)**

### Description:

This function sets the vector deceleration of the interpolation motion.

### Category:

MODBUS sub\_function; RTC, MP and ISR.

### Parameters:

Paramters	Description
<i>hEtm</i> :	TCP/IP connection handle
<i>cardNo</i> :	1 (ET-M8194H supports only one i-8094H module)
<i>data</i> :	The vector deceleration value (in PPS/sec). This value is related to the maximum speed value defined by ETM_SET_MAX_V () function. The maximum available acceleration value is MAX_V * 125. The minimum acceleration value is MAX_V ÷ 64, and all other acceleration values are the integral multipliers of this value. The practical value for application depends on the capability of the motor drive and motor.

### Return:

0: Success; Others: Fail (Please refer to chapter 2.2)

### Remark:

The Sub\_function code of ETM\_SET\_VD is 0A 5F.

The Sub\_function code of ETM\_MACRO\_SET\_VD is 0C 5F.

### MODBUS example:

ETM\_SET\_VD (hEtm, 1, 100000L);

//set the vector deceleration value of interpolation motion

//on module 1 to 100K PPS/Sec.

The MODBUS command is listed as follows:

TID (hex)	PID (hex)	Field Length (hex)	UID (hex)	FC (hex)	St_Addr. (hex)	Word Count (hex)	Byte Count (hex)
00 01	00 00	00 0D	01	10	1F 40	00 03	06
Register[]		Value (hex)		Remarks			
0		0A 5F/0C 5F		Sub_function code			
1		00 01		MSW of data			
2		86 A0		LSW of data (100000 = 0x186A0)			

## 7.2.7 Vector Acceleration Rate Setting

**eRET ETM\_SET\_VK (HANDLE hEtm, BYTE cardNo, DWORD data)**

**※Δ eRET ETM\_MACRO\_SET\_VK (HANDLE hEtm, BYTE cardNo, DWORD data)**

### Description:

Set the acceleration rate (jerk) value for interpolation motion.

### Category:

MODBUS sub\_function; RTC, MP and ISR.

### Parameters:

Parameters	Description
<i>hEtm:</i>	TCP/IP connection handle
<i>cardNo:</i>	1 (ET-M8194H supports only one i-8094H module)
<i>data:</i>	The acceleration rate (jerk) value (PPS/sec <sup>2</sup> ). This value is related to the maximum speed value defined by ETM_SET_MAX_V () function. The minimum acceleration rate is MAX_V * <b>0.0119211</b> ; The maximum acceleration rate value is <b>2,000,000,000</b> .

### Return:

0: Success; Others: Fail (Please refer to chapter 2.2)

### Remark:

The Sub\_function code of ETM\_SET\_VK is 0A 60.

The Sub\_function code of ETM\_MACRO\_SET\_VK is 0C 60.

### MODBUS example:

ETM\_SET\_VK (hEtm, 1, 10000);

//set the acceleration rate of the interpolation motion on module 1

// to 10,000 PPS/sec^2.

The MODBUS command is listed as follows:

TID (hex)	PID (hex)	Field Length (hex)	UID (hex)	FC (hex)	St_Addr. (hex)	Word Count (hex)	Byte Count (hex)
00 01	00 00	00 0D	01	10	1F 40	00 03	06
Register[]		Value (hex)		Remarks			
0		0A 60/0C 60		<i>Sub_function code</i>			
1		00 00		<i>MSW of data</i>			
2		27 10		<i>LSW of data (10000 = 0x2710)</i>			



## 7.2.8 Vector Deceleration Rate Setting

**eRET ETM\_SET\_VL (HANDLE hEtm, BYTE cardNo, DWORD data)**

**※Δ eRET ETM\_MACRO\_SET\_VL (HANDLE hEtm, BYTE cardNo, DWORD data)**

### Description:

Set the deceleration rate of the interpolation motion.

### Category:

MODBUS sub\_function; RTC, MP and ISR.

### Parameters:

Parameters	Description
<i>hEtm</i> :	TCP/IP connection handle
<i>cardNo</i> :	1 (ET-M8194H supports only one i-8094H module)
<i>data</i> :	The deceleration rate (jerk) value (PPS/sec <sup>2</sup> ). This value is related to the maximum speed value defined by ETM_SET_MAX_V () function. The minimum acceleration rate is MAX_V * <b>0.0119211;</b> The maximum acceleration rate value is <b>2,000,000,000.</b>

### Return:

0: Success; Others: Fail (Please refer to chapter 2.2)

### Remark:

The Sub\_function code of ETM\_SET\_VL is 0A 61.

The Sub\_function code of ETM\_MACRO\_SET\_VL is 0C 61.

### MODBUS example:

```
ETM_SET_VL (hEtm, 1, 10000);
```

```
//set the deceleration rate of the interpolation on module 1 to 10,000
```

```
//PPS/sec^2.
```

The MODBUS command is listed as follows:

TID (hex)	PID (hex)	Field Length (hex)	UID (hex)	FC (hex)	St_Addr. (hex)	Word Count (hex)	Byte Count (hex)
00 01	00 00	00 0D	01	10	1F 40	00 03	06
Register[]		Value (hex)		Remarks			
0		0A 61/0C 61		<i>Sub_function code</i>			
1		00 00		<i>MSW of data</i>			
2		27 10		<i>LSW of data (10000 = 0x2710)</i>			

## 7.2.9 Vector Offset Pulses Setting

**eRET ETM\_SET\_VAO (HANDLE *hEtm*, BYTE *cardNo*, long *data*)**

**※Δ eRET ETM\_MACRO\_SET\_VAO (HANDLE *hEtm*, BYTE *cardNo*, long *data*)**

### Description:

Setting this value will cause the motion control chip to start deceleration earlier. The remaining offset pulses will be completed at low speed to allow the controller to stop immediately when it reaches the offset pulse value. Please refer to the figure below for more information.

### Category:

MODBUS sub\_function; RTC, MP and ISR.

### Parameters:

Paramters	Description
<i>hEtm</i> :	TCP/IP connection handle
<i>cardNo</i> :	1 (ET-M8194H supports only one i-8094H module)
<i>data</i> :	The number of remaining offset pulses. (-32,768 ~ +32,767).

### Return:

0: Success; Others: Fail (Please refer to chapter 2.2)

### Remark:

The Sub\_function code of ETM\_SET\_VAO is 0A 62.

The Sub\_function code of ETM\_MACRO\_SET\_VAO is 0C 62.

### MODBUS example:

ETM\_SET\_VAO (hEtm, 1, 200);

//set the number of remaining offset pulse value on module 1 to 200.

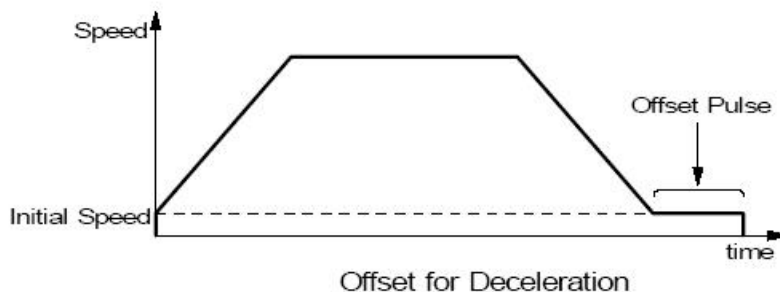

The MODBUS command is listed as follows:

TID (hex)	PID (hex)	Field Length (hex)	UID (hex)	FC (hex)	St_Addr. (hex)	Word Count (hex)	Byte Count (hex)
00 01	00 00	00 0D	01	10	1F 40	00 03	06
Register[]		Value (hex)		Remarks			
0		0A 62/0C 62		<i>Sub_function code</i>			
1		00 00		<i>MSW of data</i>			
2		00 C8		<i>LSW of data (200 = 0xC8)</i>			

## 7.2.10 2-Axis Interpolation Relative Distance Motion

**eRET** ETM\_LINE\_2D (**HANDLE** *hEtm*, **BYTE** *cardNo*, **long** *fp1*, **long** *fp2*)

※**Δ eRET** ETM\_MACRO\_LINE\_2D (**HANDLE** *hEtm*, **BYTE** *cardNo*, **long** *fp1*, **long** *fp2*)

### Description:

This function executes a 2-axis linear interpolation motion.

### Category:

MODBUS sub\_function; RTC, MP and ISR.

### Parameters:

Parameters	Description
<i>hEtm</i> :	TCP/IP connection handle
<i>cardNo</i> :	1 (ET-M8194H supports only one i-8094H module)
<i>fp1</i> :	The displacement of the axis 1 in Pulses (-2,000,000,000 ~ +2,000,000,000)
<i>fp2</i> :	The displacement of the axis 2 in Pulses (-2,000,000,000 ~ +2,000,000,000)

### Return:

0: Success; Others: Fail (Please refer to chapter 2.2)

### Remark:

The Sub\_function code of ETM\_LINE\_2D is 0A 63.

The Sub\_function code of ETM\_MACRO\_LINE\_2D is 0C 63.

### MODBUS example:

ETM\_LINE\_2D (hEtm, 1, 12000, 10000);

//execute the 2-axis linear interpolation motion on module 1.

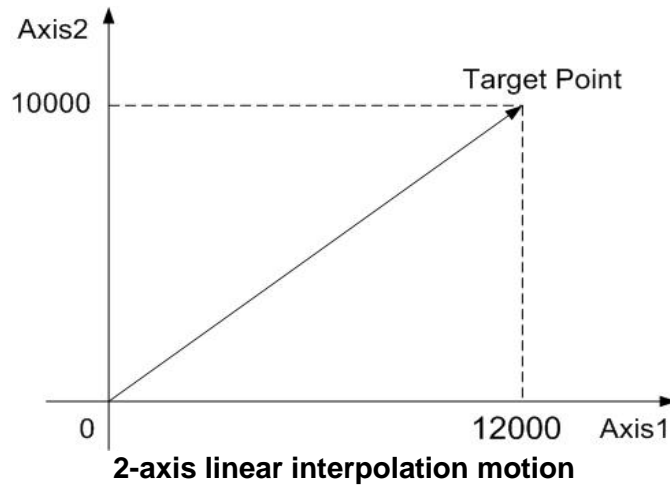

The MODBUS command is listed as follows:

TID (hex)	PID (hex)	Field Length (hex)	UID (hex)	FC (hex)	St_Addr. (hex)	Word Count (hex)	Byte Count (hex)
00 01	00 00	00 11	01	10	1F 40	00 05	0A
Register[]		Value (hex)		Remarks			
0		0A 63/0C 63		Sub_function code			
1		00 00		MSW of fp1			
2		2E E0		LSW of fp1 (12000 = 0x2EE0)			
3		00 00		MSW of fp2			
4		27 10		LSW of fp2 (10000 = 0x2710)			

## 7.2.11 2-Axis Interpolation Absoul Position Motion

**eRET** ETM\_ABS\_LINE\_2D (**HANDLE** *hEtm*, **BYTE** *cardNo*, **long** *fp1*, **long** *fp2*)

**※Δ eRET** ETM\_ABS\_MACRO\_LINE\_2D (**HANDLE** *hEtm*, **BYTE** *cardNo*, **long** *fp1*, **long** *fp2*)

### Description:

This function commands a controlled a 2-axis linear interpolation motion to a specified absolute position.

### Category:

MODBUS sub\_function; RTC, MP and ISR.

### Parameters:

Paramters	Description
<i>hEtm</i> :	TCP/IP connection handle
<i>cardNo</i> :	1 (ET-M8194H supports only one i-8094H module)
<i>fp1</i> :	Absolute position of axis 1 in Pulses (-2,000,000,000 ~ +2,000,000,000)
<i>fp2</i> :	Absolute position of axis 2 in Pulses (-2,000,000,000 ~ +2,000,000,000)

### Return:

0: Success; Others: Fail (Please refer to chapter 2.2)

### Remark:

The Sub\_function code of ETM\_ABS\_LINE\_2D is 0x0AF7.

The Sub\_function code of ETM\_ABS\_MACRO\_LINE\_2D is 0x0CFX.

### MODBUS example:

ETM\_ABS\_LINE\_2D (hEtm, 1, 12000, 10000);

//Moves from the origin to the absolute position (12000, 10000)

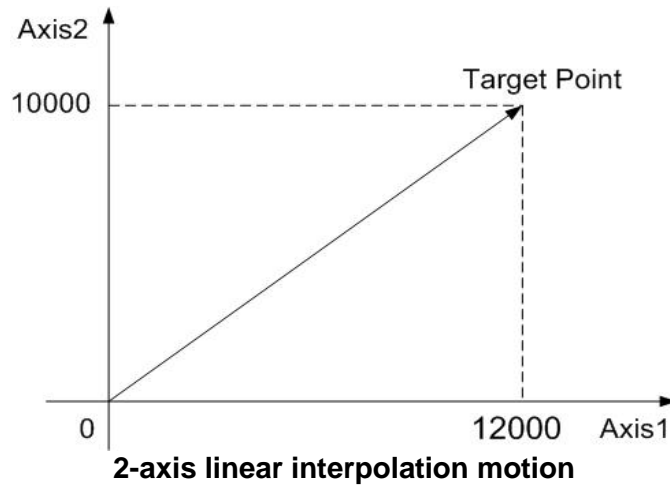

The MODBUS command is listed as follows:

TID (hex)	PID (hex)	Field Length (hex)	UID (hex)	FC (hex)	St_Addr. (hex)	Word Count (hex)	Byte Count (hex)
00 01	00 00	00 11	01	10	1F 40	00 05	0A
Register[]		Value (hex)		Remarks			
0		0A FX/0C FX		Sub_function code			
1		00 00		MSW of fp1			
2		2E E0		LSW of fp1 (12000 = 0x2EE0)			
3		00 00		MSW of fp2			
4		27 10		LSW of fp2 (10000 = 0x2710)			



## 7.2.12 3-Axis Interpolation Relative Distance Motion

**eRET ETM\_LINE\_3D (HANDLE *hEtm*, BYTE *cardNo*, long *fp1*, long *fp2*, long *fp3*)**

**※Δ eRET ETM\_MACRO\_LINE\_3D (HANDLE *hEtm*, BYTE *cardNo*, long *fp1*, long *fp2*, long *fp3*)**

### Description:

This function executes a 3-axis linear interpolation motion.

### Category:

MODBUS sub\_function; RTC, MP and ISR.

### Parameters:

Paramters	Description
<i>hEtm</i> :	TCP/IP connection handle
<i>cardNo</i> :	1 (ET-M8194H supports only one i-8094H module)
<i>fp1</i> :	The displacement of the first axis (axis 1) in Pulses(-2,000,000,000 ~ +2,000,000,000)
<i>fp2</i> :	The displacement of the second axis (axis 2) in Pulses(-2,000,000,000 ~ +2,000,000,000)
<i>fp3</i> :	The displacement of the third axis (axis 3) in Pulses(-2,000,000,000 ~ +2,000,000,000)

### Return:

0: Success; Others: Fail (Please refer to chapter 2.2)

Use the ETM\_GET\_ERROR\_CODE() function to identify the errors.

### Remark:

The Sub\_function code of ETM\_LINE\_3D is 0A 64.

The Sub\_function code of ETM\_MACRO\_LINE\_3D is 0C 64.

### MODBUS example:

```
ETM_LINE_3D (hEtm, 1, 10000, 10000, 10000);
```

```
//execute the 3-axis linear interpolation motion on module 1.
```

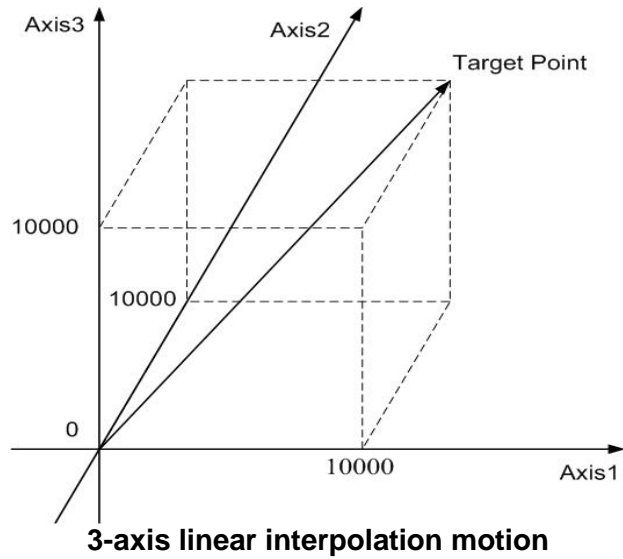

The MODBUS command is listed as follows:

TID (hex)	PID (hex)	Field Length (hex)	UID (hex)	FC (hex)	St_Addr. (hex)	Word Count (hex)	Byte Count (hex)
00 01	00 00	00 15	01	10	1F 40	00 07	0E
Register[]		Value (hex)		Remarks			
0		0A 64/0C 64		Sub_function code			
1		00 00		MSW of fp1			
2		27 10		LSW of fp1 (10000 = 0x2710)			
3		00 00		MSW of fp2			
4		27 10		LSW of fp2 (10000 = 0x2710)			
5		00 00		MSW of fp3			
6		27 10		LSW of fp3 (10000 = 0x2710)			

## 7.2.13 3-Axis Interpolation Absolute Position Motion

**eRET ETM\_ABS\_LINE\_3D (HANDLE *hEtm*, BYTE *cardNo*, long *fp1*, long *fp2*, long *fp3*)**

**※Δ eRET ETM\_ABS\_MACRO\_LINE\_3D (HANDLE *hEtm*, BYTE *cardNo*, long *fp1*, long *fp2*, long *fp3*)**

### Description:

This function executes a 3-axis linear interpolation motion to the specified absolute position.

### Category:

MODBUS sub\_function; RTC, MP and ISR.

### Parameters:

Parameters	Description
<i>hEtm</i> :	TCP/IP connection handle
<i>cardNo</i> :	1 (ET-M8194H supports only one i-8094H module)
<i>fp1</i> :	Absolute position of axis 1 in Pulses(-2,000,000,000 ~ +2,000,000,000)
<i>fp2</i> :	Absolute position of axis 2 in Pulses(-2,000,000,000 ~ +2,000,000,000)
<i>fp3</i> :	Absolute position of axis 2 in Pulses(-2,000,000,000 ~ +2,000,000,000)

### Return:

0: Success; Others: Fail (Please refer to chapter 2.2)

Use the ETM\_GET\_ERROR\_CODE() function to identify the errors.

### Remark:

The Sub\_function code of ETM\_LINE\_3D is 0x0AF8.

The Sub\_function code of ETM\_MACRO\_LINE\_3D is 0x0CF8.

### MODBUS example:

```
ETM_ABS_LINE_3D (hEtm, 1, 10000, 10000, 10000);
```

```
//Move to the specified target position.
```

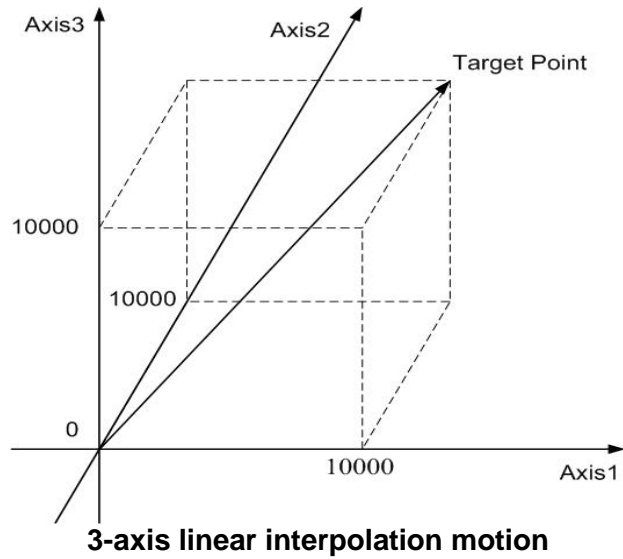

The MODBUS command is listed as follows:

TID (hex)	PID (hex)	Field Length (hex)	UID (hex)	FC (hex)	St_Addr. (hex)	Word Count (hex)	Byte Count (hex)
00 01	00 00	00 15	01	10	1F 40	00 07	0E
Register[]		Value (hex)		Remarks			
0		0A F8/0C F8		Sub_function code			
1		00 00		MSW of fp1			
2		27 10		LSW of fp1 (10000 = 0x2710)			
3		00 00		MSW of fp2			
4		27 10		LSW of fp2 (10000 = 0x2710)			
5		00 00		MSW of fp3			
6		27 10		LSW of fp3 (10000 = 0x2710)			

## 7.2.14 2-Axis Circular Interpolation Relative Distance Motion (an CW Arc)

**eRET ETM\_ARC\_CW (HANDLE *hEtm*, BYTE *cardNo*, long *cp1*, long *cp2*, long *fp1*, long *fp2*)**

**※Δ eRET ETM\_MACRO\_ARC\_CW (HANDLE *hEtm*, BYTE *cardNo*, long *cp1*, long *cp2*, long *fp1*, long *fp2*)**

**Description:**

This function executes a 2-axis circular interpolation motion in a clockwise (CW) direction.

**Category:**

MODBUS sub\_function; RTC, MP and ISR.

**Parameters:**

Paramters	Description
<i>hEtm</i> :	TCP/IP connection handle
<i>cardNo</i> :	1 (ET-M8194H supports only one i-8094H module)
<i>cp1</i> :	The relative position of the center to the current position of axis 1 in pulses. (-2,000,000,000 ~ +2,000,000,000).
<i>cp2</i> :	The relative position of the center to the current position of axis 2 in pulses. (-2,000,000,000 ~ +2,000,000,000).
<i>fp1</i> :	The displacement of the axis 1 in Pulses (-2,000,000,000 ~ +2,000,000,000)
<i>fp2</i> :	The displacement of the axis 2 in Pulses (-2,000,000,000 ~ +2,000,000,000)

**Return:**

0: Success; Others: Fail (Please refer to chapter 2.2)  
Use the ETM\_GET\_ERROR\_CODE() function to identify the errors.

**Remark:**

The Sub\_function code of ETM\_ARC\_CW is 0A 65.  
The Sub\_function code of ETM\_MACRO\_ARC\_CW is 0C 65.

**MODBUS example:**

```
ETM_ARC_CW (hEtm, 1, -5000, -5000, -10000, -10000);
// Issues a command to perform a circular motion (an arc)
in a CW direction. Please refer to the following figure.
```

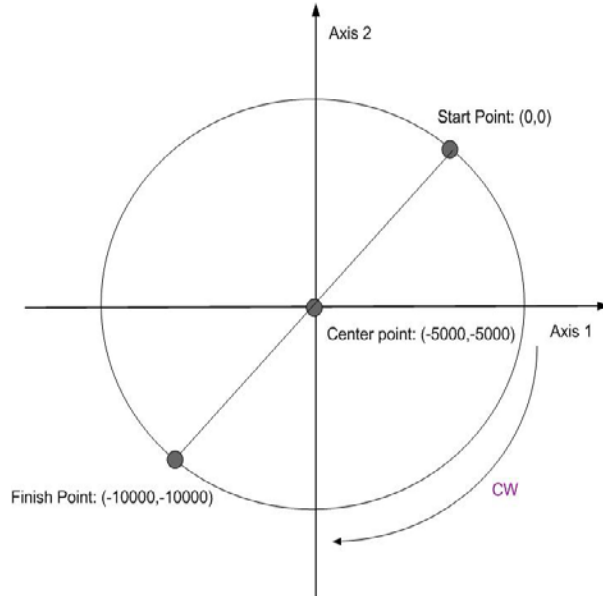

2-axis circular motion in a CW direction

The MODBUS command is listed as follows:

TID (hex)	PID (hex)	Field Length (hex)	UID (hex)	FC (hex)	St_Addr. (hex)	Word Count (hex)	Byte Count (hex)
00 01	00 00	00 19	01	10	1F 40	00 09	12
Register[]	Value (hex)	Remarks					
0	0A 65/0C 65	Sub_function code					
1	FF FF	MSW of cp1					
2	EC 78	LSW of cp1 (-5000 = 0xFFFFEC78)					
3	FF FF	MSW of cp2					
4	EC 78	LSW of cp2 (-5000 = 0xFFFFEC78)					
5	FF FF	MSW of fp1					
6	D8 F0	LSW of fp1 (-10000 = 0xFFFFD8F0)					
7	FF FF	MSW of fp2					
8	D8 F0	LSW of fp2 (-10000 = 0xFFFFD8F0)					

## 7.2.15 2-Axis Circular Interpolation Relative Distance Motion (an CCW Arc)

**eRET ETM\_ARC\_CCW (HANDLE *hEtm*, BYTE *cardNo*, long *cp1*, long *cp2*, long *fp1*, long *fp2*)**

**※Δ eRET ETM\_MACRO\_ARC\_CCW (HANDLE *hEtm*, BYTE *cardNo*, long *cp1*, long *cp2*, long *fp1*, long *fp2*)**

**Description:**

This function executes a 2-axis circular interpolation motion in a counter-clockwise (CCW) direction.

**Category:**

MODBUS sub\_function; RTC, MP and ISR.

**Parameters:**

Paramters	Description
<i>hEtm</i> :	TCP/IP connection handle
<i>cardNo</i> :	1 (ET-M8194H supports only one i-8094H module)
<i>cp1</i> :	The relative position of the center to the current position of axis 1 in pulses. (-2,000,000,000 ~ +2,000,000,000).
<i>cp2</i> :	The relative position of the center to the current position of axis 2 in pulses. (-2,000,000,000 ~ +2,000,000,000).
<i>fp1</i> :	The displacement of the axis 1 in Pulses (-2,000,000,000 ~ +2,000,000,000)
<i>fp2</i> :	The displacement of the axis 2 in Pulses (-2,000,000,000 ~ +2,000,000,000)

**Return:**

0: Success; Others: Fail (Please refer to chapter 2.2)

Use the ETM\_GET\_ERROR\_CODE() function to identify the errors.

**Remark:**

The Sub\_function code of ETM\_ARC\_CCW is 0A 67.

The Sub\_function code of ETM\_MACRO\_ARC\_CCW is 0C 67.

**MODBUS example:**

ETM\_ARC\_CCW (hEtm, 1, -5000, -5000, -10000, -10000);

// Issues a command to perform a circular motion (an arc)  
in a CCW direction. Please refer to the following figure.

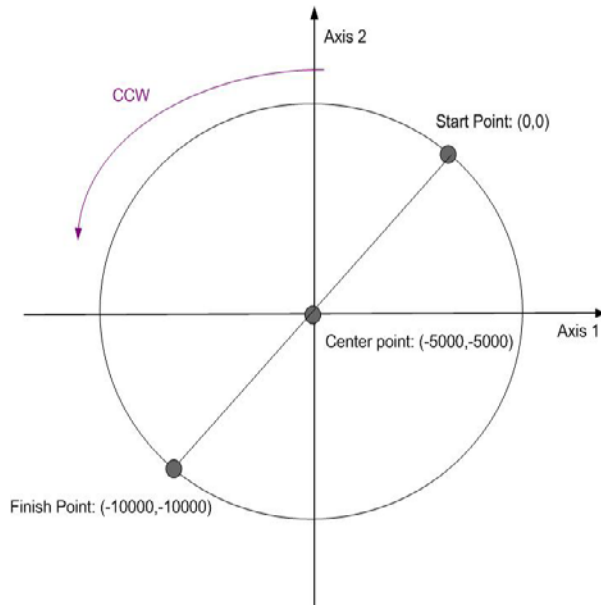

2-axis circular motion in a CW direction

The MODBUS command is listed as follows:

TID (hex)	PID (hex)	Field Length (hex)	UID (hex)	FC (hex)	St_Addr. (hex)	Word Count (hex)	Byte Count (hex)
00 01	00 00	00 19	01	10	1F 40	00 09	12
Register[]	Value (hex)	Remarks					
0	0A 67/0C 67	Sub_function code					
1	FF FF	MSW of cp1					
2	EC 78	LSW of cp1 (-5000 = 0xFFFFEC78)					
3	FF FF	MSW of cp2					
4	EC 78	LSW of cp2 (-5000 = 0xFFFFEC78)					
5	FF FF	MSW of fp1					
6	D8 F0	LSW of fp1 (-10000 = 0xFFFFD8F0)					
7	FF FF	MSW of fp2					
8	D8 F0	LSW of fp2 (-10000 = 0xFFFFD8F0)					



## 7.2.16 2-Axis Circular Interpolation Absolut Position Motion (an CW Arc)

**eRET** ETM\_ABS\_ARC\_CW (**HANDLE** *hEtm*, **BYTE** *cardNo*, **long** *cp1*,  
**long** *cp2*, **long** *fp1*, **long** *fp2*)

※**Δ** **eRET** ETM\_ABS\_MACRO\_ARC\_CW (**HANDLE** *hEtm*, **BYTE** *cardNo*,  
**long** *cp1*, **long** *cp2*, **long** *fp1*, **long** *fp2*)

### Description:

This function executes a 2-axis circular interpolation motion in a clockwise (CW) direction.

### Category:

MODBUS sub\_function; RTC, MP and ISR.

### Parameters:

Paramters	Description
<i>hEtm</i> :	TCP/IP connection handle
<i>cardNo</i> :	1 (ET-M8194H supports only one i-8094H module)
<i>cp1</i> :	The absolute position of the center to the current position of axis 1 in pulses. (-2,000,000,000 ~ +2,000,000,000).
<i>cp2</i> :	The absolute position of the center to the current position of axis 2 in pulses. (-2,000,000,000 ~ +2,000,000,000).
<i>fp1</i> :	The absolute position of the axis 1 in Pulses (-2,000,000,000 ~ +2,000,000,000)
<i>fp2</i> :	The absolute position of the axis 2 in Pulses (-2,000,000,000 ~ +2,000,000,000)

### Return:

0: Success; Others: Fail (Please refer to chapter 2.2)

Use the ETM\_GET\_ERROR\_CODE() function to identify the errors.

### Remark:

The Sub\_function code of ETM\_ABS\_ARC\_CW is 0x0AF9.

The Sub\_function code of ETM\_ABS\_MACRO\_ARC\_CW is 0x0CF9.

### MODBUS example:

ETM\_ABS\_ARC\_CW (hEtm, 1, -5000, -5000, -10000, -10000);

// Issues a command to perform a circular motion (an arc)  
in a CW direction. Please refer to the following figure.

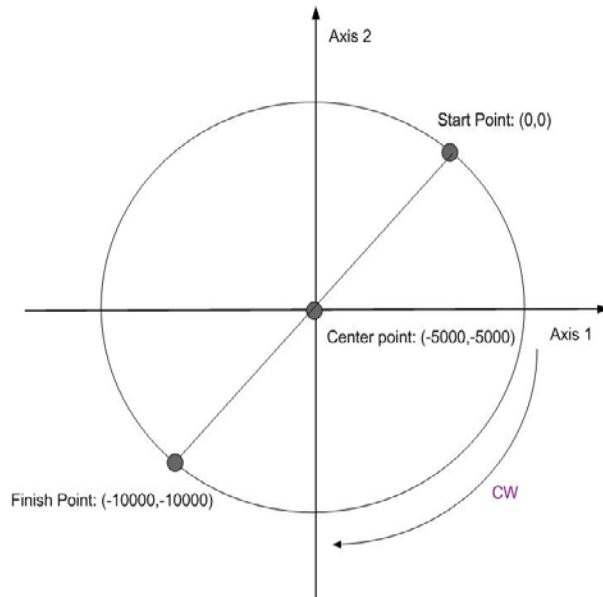

2-axis circular motion in a CW direction

The MODBUS command is listed as follows:

TID (hex)	PID (hex)	Field Length (hex)	UID (hex)	FC (hex)	St_Addr. (hex)	Word Count (hex)	Byte Count (hex)
00 01	00 00	00 19	01	10	1F 40	00 09	12
Register[]	Value (hex)	Remarks					
0	0A F9/0C F9	Sub_function code					
1	FF FF	MSW of cp1					
2	EC 78	LSW of cp1 (-5000 = 0xFFFFEC78)					
3	FF FF	MSW of cp2					
4	EC 78	LSW of cp2 (-5000 = 0xFFFFEC78)					
5	FF FF	MSW of fp1					
6	D8 F0	LSW of fp1 (-10000 = 0xFFFFD8F0)					
7	FF FF	MSW of fp2					
8	D8 F0	LSW of fp2 (-10000 = 0xFFFFD8F0)					

## 7.2.17 2-Axis Circular Interpolation Absoul Position Motion (an CCW Arc)

**eRET** ETM\_ABS\_ARC\_CCW (**HANDLE** *hEtm*, **BYTE** *cardNo*, **long** *cp1*,  
**long** *cp2*, **long** *fp1*, **long** *fp2*)

**※Δ eRET** ETM\_ABS\_MACRO\_ARC\_CCW (**HANDLE** *hEtm*, **BYTE** *cardNo*,  
**long** *cp1*, **long** *cp2*, **long** *fp1*, **long** *fp2*)

### Description:

This function commands a controlled 2-axis circular interpolation motion in a counter-clockwise (CCW) direction.

### Category:

MODBUS sub\_function; RTC, MP and ISR.

### Parameters:

Paramters	Description
<i>hEtm</i> :	TCP/IP connection handle
<i>cardNo</i> :	1 (ET-M8194H supports only one i-8094H module)
<i>cp1</i> :	The absolute position of the center of axis 1 in pulses. (-2,000,000,000 ~ +2,000,000,000).
<i>cp2</i> :	The absolute position of the center of axis 2 in pulses. (-2,000,000,000 ~ +2,000,000,000).
<i>fp1</i> :	The absolute position of the axis 1 in Pulses (-2,000,000,000 ~ +2,000,000,000)
<i>fp2</i> :	The absolute position of the axis 2 in Pulses (-2,000,000,000 ~ +2,000,000,000)

### Return:

0: Success; Others: Fail (Please refer to chapter 2.2)

Use the ETM\_GET\_ERROR\_CODE() function to identify the errors.

### Remark:

The Sub\_function code of ETM\_ABS\_ARC\_CCW is 0x0AFA.

The Sub\_function code of ETM\_ABS\_MACRO\_ARC\_CCW is 0x0CFA.

### MODBUS example:

ETM\_ARC\_CCW (hEtm, 1, -5000, -5000, -10000, -10000);

// Issues a command to perform a circular motion (an arc)  
in a CCW direction. Please refer to the following figure.

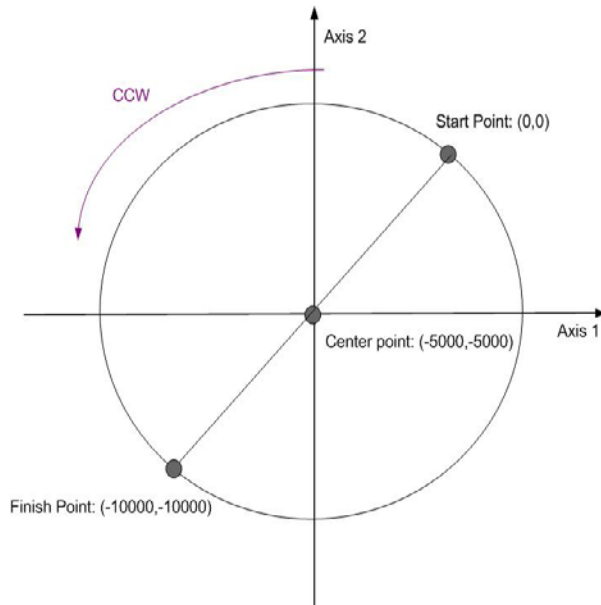

2-axis circular motion in a CW direction

The MODBUS command is listed as follows:

TID (hex)	PID (hex)	Field Length (hex)	UID (hex)	FC (hex)	St_Addr. (hex)	Word Count (hex)	Byte Count (hex)
00 01	00 00	00 19	01	10	1F 40	00 09	12
Register[]	Value (hex)	Remarks					
0	0A FA/0C FA	Sub_function code					
1	FF FF	MSW of cp1					
2	EC 78	LSW of cp1 (-5000 = 0xFFFFEC78)					
3	FF FF	MSW of cp2					
4	EC 78	LSW of cp2 (-5000 = 0xFFFFEC78)					
5	FF FF	MSW of fp1					
6	D8 F0	LSW of fp1 (-10000 = 0xFFFFD8F0)					
7	FF FF	MSW of fp2					
8	D8 F0	LSW of fp2 (-10000 = 0xFFFFD8F0)					

## 7.2.18 2-Axis Circular Interpolation Motion (Complete CW Circle)

<b>eRET</b> ETM_CIRCLE_CW ( <b>HANDLE</b> <i>hEtm</i> , <b>BYTE</b> <i>cardNo</i> , <b>long</b> <i>cp1</i> , <b>long</b> <i>cp2</i> ) <b>※Δ eRET</b> ETM_MACRO_CIRCLE_CW ( <b>HANDLE</b> <i>hEtm</i> , <b>BYTE</b> <i>cardNo</i> , <b>long</b> <i>cp1</i> , <b>long</b> <i>cp2</i> )
---

### Description:

This function executes a 2-axis circular interpolation motion in a clockwise (CW) direction.

### Category:

MODBUS sub\_function; RTC, MP and ISR.

### Parameters:

Parameters	Description
<i>hEtm</i> :	TCP/IP connection handle
<i>cardNo</i> :	1 (ET-M8194H supports only one i-8094H module)
<i>cp1</i> :	The relative position of the center to the current position of axis 1 in pulses. (-2,000,000,000 ~ +2,000,000,000).
<i>cp2</i> :	The relative position of the center to the current position of axis 2 in pulses. (-2,000,000,000 ~ +2,000,000,000).

### Return:

0: Success; Others: Fail (Please refer to chapter 2.2)

Use the ETM\_GET\_ERROR\_CODE() function to identify the errors.

### Remark:

The Sub\_function code of ETM\_CIRCLE\_CW is 0A 69.

The Sub\_function code of ETM\_MACRO\_CIRCLE\_CW is 0C 69.

### MODBUS example:

```
ETM_CIRCLE_CW (hEtm, 1, 0, 10000);
// execute a circular motion (a complete circle) in a CW direction
// on module 1.
```

The MODBUS command is listed as follows:

TID (hex)	PID (hex)	Field Length (hex)	UID (hex)	FC (hex)	St_Addr. (hex)	Word Count (hex)	Byte Count (hex)
00 01	00 00	00 11	01	10	1F 40	00 05	0A
Register[]		Value (hex)		Remarks			
0		0A 69/0C 69		<i>Sub_function code</i>			
1		00 00		<i>MSW of cp1</i>			
2		00 00		<i>LSW of cp1 (0 = 0x0)</i>			
3		00 00		<i>MSW of cp2</i>			
4		27 10		<i>LSW of cp2 (10000 = 0x2710)</i>			

## 7.2.19 2-Axis Circular Interpolation Motion (Complete CCW Circle)

**eRET** ETM\_CIRCLE\_CCW (**HANDLE** *hEtm*, **BYTE** *cardNo*, **long** *cp1*, **long** *cp2*)

**※Δ eRET** ETM\_MACRO\_CIRCLE\_CCW (**HANDLE** *hEtm*, **BYTE** *cardNo*, **long** *cp1*, **long** *cp2*)

### Description:

This function executes a 2-axis circular interpolation motion in a counter-clockwise (CCW) direction.

### Category:

MODBUS sub\_function; RTC, MP and ISR.

### Parameters:

Parameters	Description
<i>hEtm</i> :	TCP/IP connection handle
<i>cardNo</i> :	1 (ET-M8194H supports only one i-8094H module)
<i>cp1</i> :	The relative position of the center to the current position of axis 1 in pulses. (-2,000,000,000 ~ +2,000,000,000).
<i>cp2</i> :	The relative position of the center to the current position of axis 2 in pulses. (-2,000,000,000 ~ +2,000,000,000).

### Return:

0: Success; Others: Fail (Please refer to chapter 2.2)

Use the ETM\_GET\_ERROR\_CODE() function to identify the errors.

### Remark:

The Sub\_function code of ETM\_CIRCLE\_CCW is 0A 6A.

The Sub\_function code of ETM\_MACRO\_CIRCLE\_CCW is 0C 6A.

### MODBUS example:

ETM\_CIRCLE\_CCW (hEtm, 1, 0, 10000);

// execute a circular motion (a complete circle) in a CCW direction

//on module 1.

The MODBUS command is listed as follows:

TID (hex)	PID (hex)	Field Length (hex)	UID (hex)	FC (hex)	St_Addr. (hex)	Word Count (hex)	Byte Count (hex)
00 01	00 00	00 11	01	10	1F 40	00 05	0A
Register[]	Value (hex)	Remarks					
0	0A 6A/0C 6A	<i>Sub_function code</i>					
1	00 00	<i>MSW of cp1</i>					
2	00 00	<i>LSW of cp1 (0 = 0x0)</i>					
3	00 00	<i>MSW of cp2</i>					
4	27 10	<i>LSW of cp2 (10000 = 0x2710)</i>					



## 7.3 Synchronous Actions

### 7.3.1 Setting the Activation Factors

```
eRET ETM_SYNC_ACTION (HANDLE hEtm, BYTE cardNo, BYTE axis1,
BYTE axis2, DWORD nSYNC, BYTE nDRV, BYTE nLATCH, BYTE
nPRESET, BYTE nOUT, BYTE nINT, BYTE isrNoX, BYTE isrNoY,
BYTE isrNoZ, BYTE isrNoU)
```

```
※Δ eRET ETM_MACRO_SYNC_ACTION (HANDLE hEtm, BYTE cardNo,
BYTE axis1, BYTE axis2, DWORD nSYNC, BYTE nDRV, BYTE
nLATCH, BYTE nPRESET, BYTE nOUT, BYTE nINT, BYTE isrNoX,
BYTE isrNoY, BYTE isrNoZ, BYTE isrNoU)
```

**Description:**

This function sets the activation factors for synchronous action.

**Category:**

MODBUS sub\_function; RTC, MP and ISR.

**Parameters:**

Paramters	Description
<i>hEtm:</i>	TCP/IP connection handle
<i>cardNo:</i>	1 (ET-M8194H supports only one i-8094H module)
<i>axis1:</i>	This is the monitored axis. It will be checked by hardware. The axis can be either X, Y, Z or U (1 or 2 or 4 or 8) (Please refer to Table 3).
<i>axis2:</i>	This defined the other axes (or axis) that will take action when one of the activation factors occurs.

**nSYNC:** It defines the activation factors. Multiple activation factors can be defined at the same time. Available active factors are listed in the following table.

Value	Event	Explanation
0x00000000		Disable the synchronous action
0x00000001	$P \geq C+$	The logical/real position counter value exceeded the COMP+ register value. Use the ETM_SET_COMPARE () function for selection of a logical/real position (7.3.6).
0x00000002	$P < C+$	The logical/real position counter value became less than the COMP+ register value. Use the ETM_SET_COMPARE () function for selection of a logical/real position (7.3.6).
0x00000004	$P < C-$	The logical/real position counter value became less than the COMP- register value. Use the ETM_SET_COMPARE () function for selection of a logical/real position (7.3.6).
0x00000008	$P \geq C-$	The logical/real position counter value exceeded the COMP- register value. Use the ETM_SET_COMPARE () function for selection of a logical/real position (7.3.6).
0x00000010	D-STA	Driving started.
0x00000020	D-END	Driving terminated.
0x00000040	IN3 $\uparrow$	The nIN3 signal rose from the Low to the High level.
0x00000080	IN3 $\downarrow$	The nIN3 signal fell from the High to the Low level.

**Example:** Choose  $P \geq C+$  and IN3  $\uparrow$  (0x00000001 + 0x00000040 = 0x00000041)

***nDRV***: It defines the actions that are related with axial driving. Available actions are listed in the following table. Only one driving action can be chosen.

Value	Symbol	Explanation
0		Disable driving action.
1	FDRV+	Activates fixed pulse driving in the + direction. It must set the <i>nPRESET</i> value to be "OPSET" which indicates that ETM_SET_PRESET() function will set the offset value for this FDRV. Therefore, the companion function, ETM_SET_PRESET(), is necessary. However, this command does not take effect if the assigned axes, <i>axis2</i> , are moving.
2	FDRV-	Activates fixed pulse driving in the - direction. It must set the <i>nPRESET</i> value to be "OPSET" which indicates that ETM_SET_PRESET() function will set the offset value for this FDRV. Therefore, the companion function, ETM_SET_PRESET(), is necessary. However, this command does not take effect if the assigned axes, <i>axis2</i> , are moving.
3	CDRV+	Activates continuous pulse driving in the + direction. However, this command does not take effect if the assigned axes, <i>axis2</i> , are moving
4	CDRV-	Activates continuous pulse driving in the - direction. However, this command does not take effect if the assigned axes, <i>axis2</i> , are moving.
5	SSTOP	Stop driving in deceleration
6	ISTOP	Stop driving immediately

**nLATCH:** It defines the actions that is related of latching position. Available actions are listed in the following table. Only one of these actions can be chosen

Value	Symbol	Explanation
0		Disable position latch function
1	LPSAV	Saves the current logical position counter value (LP) in the synchronous buffer register (BR). [LP → LATCH]
2	EPSAV	Saves the current real position counter value (EP) in the synchronous buffer register (BR). [EP → LATCH]

After the event has occurred, the ETM\_GET\_LATCH() function can be use to get the latched value.

**nPRESET:** It defines the actions that is related of latching position. Available actions are listed in the following table. Only one of these actions can be chosen.

Value	Symbol	Explanation
0		Disable setting function
1	LPSET	Indicates that a new value for the logical position (LP) will be set. The new value will be set by ETM_SET_PRESET() function. [LP ← PRESET]
2	EPSET	Indicates that a new value for the real position (EP) will be set. The new value will be set by ETM_SET_PRESET() function. [EP ← PRESET]
3	OPSET	Indicates that a new offset value (P) for the fixed pulse driving will be set. The new value will be set by ETM_SET_PRESET() function. [P ← PRESET] This setting is invalid to the Finish-Point of the axes in CONTINUE_MOVE.
4	VLSET	Indicates that a new speed value (V) will be set. The new value will be set by ETM_SET_PRESET() function. [V ← PRESET]

Must be used with ETM\_SET\_PRESET together, please refer to section 7.3.4.

**nOUT:** setting trigger output, as the following table:

Value	Symbol	Explanation
0		Disable trigger output
1	OUT	Enable trigger output

Must be used with ETM\_SET\_OUT together, please refer to section 7.3.5.

***nINT***: setting interrupt function, as the following table:

Value	Symbol	Explanation
0		Disable interrupt function
1	INT	Enable interrupt function

1. It will generate a interrupt for the synchronous action of axis2, please write the corresponding number: *isrNoX* \ *isrNoY* \ *isrNoZ* \ *isrNoU*

2. Must be used with `ETM_ENABLE_INT` together, please refer to section 7.3.6.

***isrNoX***: ISR1 ~ ISR20 : Specify the interrupt number of X-axis.

0: disable

***isrNoY***: ISR1 ~ ISR20 : Specify the interrupt number of Y-axis.

0: disable

***isrNoZ***: ISR1 ~ ISR20 : Specify the interrupt number of Z-axis.

0: disable

***isrNoU***: ISR1 ~ ISR20 : Specify the interrupt number of U-axis.

0: disable

**Return:**

0: Success; Others: Fail (Please refer to chapter 2.2)

**Remark:**

The Sub\_function code of `ETM_SYNC_ACTION` is 0A 6E.

The Sub\_function code of `ETM_MACRO_SYNC_ACTION` is 0C 6E.

**MODBUS example:**

`ETM_SYNC_ACTION (hEtm, cardNo, AXIS_U, AXIS_U, 0X00000040, 0, 2, 4, 0, 0, 0, 0, 0, 0);`

The MODBUS command is listed as follows:

TID (hex)	PID (hex)	Field Length (hex)	UID (hex)	FC (hex)	St_Addr. (hex)	Word Count (hex)	Byte Count (hex)
00 01	00 00	00 23	01	10	1F 40	00 0E	1C
Register[]	Value (hex)	Remarks					
0	0A 6E/0C 6E	<i>Sub_function code</i>					
1	00 08	<i>axis1 (8 = AXIS_U)</i>					
2	00 08	<i>axis2</i>					
3	00 00	<i>MSW of nSYNC</i>					
4	00 40	<i>LSW of nSYNC (0x40 → rising edge of IN3 will trigger the action)</i>					
5	00 00	<i>nDRV (0 → no driving control)</i>					
6	00 02	<i>nLATCH (2 → will latch EP value)</i>					
7	00 04	<i>nPRESET (4 → set new velocity when SYNC condition is true)</i>					
8	00 00	<i>nOUT (0 → no pulse out)</i>					
9	00 00	<i>nINT (0 → disable)</i>					
10	00 00	<i>isrNoX (It can be any value since nINT is disable.)</i>					
11	00 00	<i>isrNoY (It can be any value since nINT is disable.)</i>					
12	00 00	<i>isrNoZ (It can be any value since nINT is disable.)</i>					
13	00 00	<i>isrNoU (It can be any value since nINT is disable.)</i>					

Related example:

```

//Example1: When the U axis received IN3 positive edge trigger signal, it
//will change the LATCH encoder value.
ETM_SYNC_ACTION(hEtm, cardNo, AXIS_U, AXIS_U, 0X00000040, 0, 2, 4, 0,
0, 0, 0, 0, 0);
ETM_SET_MAX_V(hEtm, cardNo, AXIS_U, 5000);
//Set the maximum speed of u axis on module 1 to 5K PPS.
ETM_NORMAL_SPEED(hEtm, cardNo, AXIS_U, 0);
// set the speed profile for u axis as a symmetric T-curve.
ETM_SET_V(hEtm, cardNo, AXIS_U, 2000);
// set the speed of u axis on module 1 to 2000 PPS
ETM_SET_A(hEtm, cardNo, AXIS_U, 100000);
// set the acceleration value of u axis to 100K PPS/sec.
ETM_SET_SV(hEtm, cardNo, AXIS_U, 100);
//set the start velocity of u axis to 100 PPS
ETM_FIXED_MOVE(hEtm, cardNo, AXIS_U, 10000);

```

```

//move 10000 Pulses for u axis on module 1
ETM_SET_PRESET(h cardNo, AXIS_U, 100);
// set the new speed of u axis on module 1 to 100 PPS
ETM_STOP_WAIT(hEtm, cardNo, AXIS_U);
long Vsb = ETM_GET_LATCH(hEtm, cardNo, AXIS_U);

```

**//Example2: When the EP value of u axis exceeds COMP+(5000), it will start //the Y-axis moving 2,000 PPS.**

```

ETM_SYNC_ACTION(hEtm, cardNo, AXIS_U, AXIS_Y, 0X00000001, 1, 0, 3, 0,
0, 0, 0, 0, 0);
ETM_SET_COMPARE(hEtm, cardNo, AXIS_U, 0, 1, 5000);
//Set the value of COMP+ is 5000, source reference the EP of U axis.
ETM_SET_MAX_V(hEtm, cardNo, AXIS_YU, 9000);
// Set the maximum speed of YU axes on module 1 to 9K PPS.
ETM_NORMAL_SPEED(hEtm, cardNo, AXIS_YU, 0);
// set the speed profile for YU axes as symmetric T-curve.
ETM_SET_V(hEtm, cardNo, AXIS_YU, 3000);
// set the speed of YU axes on module 1 to 3000 PPS.
ETM_SET_A(hEtm, cardNo, AXIS_YU, 200000);
// set the acceleration value of YU axes to 200K PPS/sec.
ETM_SET_SV(hEtm, cardNo, AXIS_YU, 200);
// set the start velocity of yu axes to 200 PPS
ETM_FIXED_MOVE(hEtm, cardNo, AXIS_U, 10000);
// move 10000 Pulses for U axis on module 1
ETM_SET_PRESET(hEtm, cardNo, AXIS_Y, 2000);
// Set the Y axis moving 2000 PPS

```

**//Example3: When the LP value of X axis exceeds COMP+(200), it will //start the nout output 5V of Y axis.**

```

ETM_SYNC_ACTION(hEtm, cardNo, AXIS_X, AXIS_Y, 0X00000001, 0, 0, 0, 1,
0, 0, 0, 0, 0);
ETM_SET_COMPARE(hEtm, cardNo, AXIS_X, 0, 0, 200);
//Set the value of COMP+ is 200, source reference the LP of X axis.
ETM_SET_MAX_V(hEtm, cardNo, AXIS_X, 5000);
// Set the maximum speed of X axis on module 1 to 5K PPS.
ETM_NORMAL_SPEED(hEtm, cardNo, AXIS_X, 0);
// set the speed profile for X axis as a symmetric T-curve.
ETM_SET_V(hEtm, cardNo, AXIS_X, 2000);
// set the speed of X axis on module 1 to 2000 PPS.
ETM_SET_A(hEtm, cardNo, AXIS_X, 100000);
// set the acceleration value of X axis to 100K PPS/s.
ETM_SET_SV(hEtm, cardNo, AXIS_X, 100);
// set the start velocity of X axis to 100 PPS
ETM_FIXED_MOVE(hEtm, cardNo, AXIS_X, 500);

```

```

// move 500 Pulses for X axis on module 1
ETM_SET_OUT(hEtm, cardNo, AXIS_Y, 1, 0);
// Set the Y axis high level output 5V.

//Example4: When the LP value of X axis exceeds COMP+(5000), it will
emergency stop and generate an interrupt to call ISR1.
ETM_SYNC_ACTION(hEtm, cardNo, AXIS_X, AXIS_X, 0X00000001, 6, 0, 0, 0,
1,   ISR1, 0, 0, 0);
ETM_ENABLE_INT(hEtm, cardNo); //Enable interrupt
ETM_SET_COMPARE(hEtm, cardNo, AXIS_X, 0, 0, 5000);
// Set the value of COMP+ is 5000, source reference the LP of X axis.
ETM_SET_MAX_V(hEtm, cardNo, AXIS_XY, 5000);
// Set the maximum speed of XY axes on module 1 to 5K PPS.
ETM_NORMAL_SPEED(hEtm, cardNo, AXIS_XY, 0);
// set the speed profile for XY axes as symmetric T-curve.
ETM_SET_V(hEtm, cardNo, AXIS_XY, 2000);
// set the speed of XY axes on module 1 to 2000 PPS.
ETM_SET_A(hEtm, cardNo, AXIS_XY, 100000);
// set the acceleration value of XY axes to 100K PPS/sec.
ETM_SET_SV(hEtm, cardNo, AXIS_XY, 100);
// set the start velocity of XY axes to 100 PPS.
ETM_FIXED_MOVE(hEtm, cardNo, AXIS_X, 10000);
// move 10K Pulses for X axis on module 1

```

ISR1:

```

ETM_MP_ISR_CREATE(hEtm, cardNo, ISR1); // Create ISR1
ETM_MACRO_FIXED_MOVE(hEtm, cardNo, AXIS_Y, 1000);
//move 1000 Pulses for y axis on module 1
ETM_MACRO_MP_ISR_CLOSE(hEtm, cardNo); // End ISR1

```

```

//Example5: Use the for loop to iterate, when the LP value of X axis
// exceeds COMP+(38000), it will generate an interrupt to call ISR1, and
// determine whether receive IN3 signal in the ISR1, if receive then
// emergency stop.

```

```

ETM_MP_CREATE(hEtm, cardNo, MP59); //Create a macro program MP59.
ETM_MACRO_SET_MAX_V(hEtm, cardNo, AXIS_XY, 5000);
// Set the maximum speed of XY axes on module 1 to 5K PPS.
ETM_MACRO_NORMAL_SPEED(hEtm, cardNo, AXIS_XY, 0);
// set the speed profile for XY axes as symmetric T-curve.
ETM_MACRO_SET_V(hEtm, cardNo, AXIS_XY, 2000);
// set the speed of XY axes on module 1 to 2000 PPS.
ETM_MACRO_SET_A(hEtm, cardNo, AXIS_XY, 100000);
// set the acceleration value of XY axes to 100K PPS/S.

```



```

ETM_MACRO_SET_SV(hEtm, cardNo, AXIS_XY, 100);
// set the start velocity of XY axes to 100 PPS.
ETM_MACRO_FOR(hEtm, cardNo, 100); //Set the times of for loop is 100.
ETM_MACRO_SET_LP(hEtm, cardNo, AXIS_XY, 0);
//Set the LP value of XYaxes to 0
ETM_MACRO_SET_FILTER(hEtm, cardNo, AXIS_X, 16, 1); //Set the filter of
IN3
ETM_MACRO_CLEAR_SYNC_ACTION(hEtm, cardNo, AXIS_X);
//Clear all the sync_action conditions of X axis.
ETM_MACRO_SYNC_ACTION(hEtm, cardNo, AXIS_X, AXIS_X, 0X00000001,
0, 0, 0, 0, 1, ISR1, 0, 0, 0);
// Set the LP value of X axis exceeds COMP+, it will generate an interrupt to
// call ISR1.
ETM_MACRO_ENABLE_INT(hEtm, cardNo); //Enable interrupt
ETM_MACRO_SET_COMPARE(hEtm, cardNo, AXIS_X, 0, 0, 38000);
//Set the value of COMP+ is 38000, source reference the LP of X axis.
ETM_MACRO_FIXED_MOVE(hEtm, cardNo, AXIS_X, 42000);
// move 42K Pulses for X axis on module 1
ETM_MACRO_STOP_WAIT(hEtm, cardNo, AXIS_X); //Wait until X axis stop.
ETM_MACRO_NEXT(hEtm, cardNo); //Match with for loop.
ETM_MACRO_MP_CLOSE(hEtm, cardNo); // End a macro program MP59

ISR1:
ETM_MP_ISR_CREATE(hEtm, cardNo, ISR1); //Create ISR1
ETM_MACRO_FIXED_MOVE(hEtm, cardNo, AXIS_Y, 1000);
// move 1000 Pulses for Y axis on module 1.
ETM_MACRO_SYNC_ACTION(hEtm, cardNo, AXIS_X, AXIS_X, 0X00000040,
6, 0, 0, 0, 0, 0, 0, 0, 0); //Set the X axis to receive the IN3 positive edge trigger
//signals from low level to high level, then emergency stop.
ETM_MACRO_MP_ISR_CLOSE(hEtm, cardNo); // End ISR1

```

## 7.3.2 Clear Synchronization Condition

**eRET** ETM\_CLEAR\_SYNC\_ACTION (**HANDLE** *hEtm*, **BYTE** *cardNo*, **BYTE** *triggerAxis*)

**※Δ eRET** ETM\_MACRO\_CLEAR\_SYNC\_ACTION (**HANDLE** *hEtm*, **BYTE** *cardNo*, **BYTE** *triggerAxis*)

### Description:

Clear all the synchronization conditions of the triggered axis.

### Category:

MODBUS sub\_function; RTC, MP and ISR.

### Parameters:

Paramters	Description
<i>hEtm</i> :	TCP/IP connection handle
<i>cardNo</i> :	1 (ET-M8194H supports only one i-8094H module)
<i>triggerAxis</i>	The axis number set by ETM_SYNC_ACTION (Please refer to Table 3)

### Return:

0: Success; Others: Fail (Please refer to chapter 2.2)

### Remark:

The Sub\_function code of ETM\_CLEAR\_SYNC\_ACTION is 0A 6A.  
The Sub\_function code of ETM\_MACRO\_CLEAR\_SYNC\_ACTION is 0C 6A.

### MODBUS example:

```
ETM_CLEAR_SYNC_ACTION (hEtm, 1, AXIS_X);
// Clear all the sync_action conditions of X axis.
```

The MODBUS command is listed as follows:

TID (hex)	PID (hex)	Field Length (hex)	UID (hex)	FC (hex)	St_Addr. (hex)	Word Count (hex)	Byte Count (hex)
00 01	00 00	00 0B	01	10	1F 40	00 02	04
Register[]		Value (hex)		Remarks			
0		0A 95/0C 95		Sub_function code			
1		00 01		TriggerAxis			

### 7.3.3 Set the Synchronization Condition

**eRET ETM\_SET\_ACTIVATION\_FACTORS(HANDLE *hEtm*, BYTE *cardNo*, BYTE *triggerAxis*, DWORD *nSYNC*)**

**※Δ eRET ETM\_MACRO\_SET\_ACTIVATION\_FACTORS (HANDLE *hEtm*, BYTE *cardNo*, BYTE *triggerAxis*, DWORD *nSYNC*)**

**Description:**

Set the synchronization conditions of triggered axis.

**Category:**

MODBUS sub\_function; RTC, MP and ISR.

**Parameters:**

Paramters	Description
<i>hEtm</i> :	TCP/IP connection handle
<i>cardNo</i> :	1 (ET-M8194H supports only one i-8094H module)
<i>triggerAxis</i>	Set the axis number(Please refer to Table 3)
<i>nSYNC</i> :	It defines the activation factors. Multiple activation factors can be defined at the same time. Available active factors are listed in the following table.

Value	Event	Explanation
0x00000000		Disable the synchronous action
0x00000001	P ≥ C+	The logical/real position counter value exceeded the COMP+ register value. Use the <b>ETM_SET_COMPARE ()</b> function for selection of a logical/real position (6.3.2).
0x00000002	P < C+	The logical/real position counter value became less than the COMP+ register value. Use the <b>ETM_SET_COMPARE ()</b> function for selection of a logical/real position (6.3.2).
0x00000004	P < C-	The logical/real position counter value became less than the COMP- register value. Use the <b>ETM_SET_COMPARE ()</b> function for selection of a logical/real position (6.3.2).
0x00000008	P ≥ C-	The logical/real position counter value exceeded the COMP- register value. Use the <b>ETM_SET_COMPARE ()</b> function for selection of a logical/real position (6.3.2).
0x00000010	D-STA	Driving started.
0x00000020	D-END	Driving terminated.
0x00000040	IN3 ↑	The nIN3 signal rose from the Low to the High level.
0x00000080	IN3 ↓	The nIN3 signal fell from the High to the Low level.

Example: Choose P ≥ C+ and IN3 ↑ (0x00000001 + 0x00000040 = **0x00000041**)

**Return:**

0: Success; Others: Fail (Please refer to chapter 2.2)

**Remark:**

The Sub\_function code of ETM\_SET\_ACTIVATION\_FACTORS is 0A 6A.

The Sub\_function code of ETM\_MACRO\_SET\_ACTIVATION\_FACTORS is 0C 6A.

**MODBUS example:**

ETM\_SET\_ACTIVATION\_FACTORS (hEtm, 1, AXIS\_X, 0X00000001);  
// Set the synchronization conditions of x axis is P ≥ C+.

The MODBUS command is listed as follows:

TID (hex)	PID (hex)	Field Length (hex)	UID (hex)	FC (hex)	St_Addr. (hex)	Word Count (hex)	Byte Count (hex)
00 01	00 00	00 0F	01	10	1F 40	00 04	08
Register[]		Value (hex)		Remarks			
0		0A 96/0C 96		Sub_function code			
1		00 01		TriggerAxis			
2		00 00		MSW of nSYNC			
3		00 01		LSW of nSYNC			

### 7.3.4 Set the Synchronization Axis

**eRET ETM\_SET\_ACTIVATION\_AXIS(HANDLE hEtm, BYTE cardNo, BYTE triggerAxis, BYTE activationAxis)**

**※Δ eRET ETM\_MACRO\_SET\_ACTIVATION\_AXIS (HANDLE hEtm, BYTE cardNo, BYTE triggerAxis, BYTE activationAxis)**

**Description:**

Set the synchronization axis.

**Category:**

MODBUS sub\_function; RTC, MP and ISR.

**Parameters:**

Paramters	Description
<i>hEtm:</i>	TCP/IP connection handle
<i>cardNo:</i>	1 (ET-M8194H supports only one i-8094H module)
<i>triggerAxis</i>	Set the axis number(Please refer to Table 3)
<i>activationAxis:</i>	Set the synchronization axis number(Please refer to Table 3)

**Return:**

0: Success; Others: Fail (Please refer to chapter 2.2)

**Remark:**

The Sub\_function code of ETM\_SET\_ACTIVATION\_AXIS is 0A 97.

The Sub\_function code of ETM\_MACRO\_SET\_ACTIVATION\_AXIS is 0C 97.

**MODBUS example:**

ETM\_SET\_ACTIVATION\_AXIS (hEtm, 1, AXIS\_X, AXIS\_Y);

// Set the synchronization axis of x axis is y axis.

The MODBUS command is listed as follows:

TID (hex)	PID (hex)	Field Length (hex)	UID (hex)	FC (hex)	St_Addr. (hex)	Word Count (hex)	Byte Count (hex)
00 01	00 00	00 0D	01	10	1F 40	00 03	06
Register[]	Value (hex)	Remarks					
0	0A 97/0C 97	Sub_function code					
1	00 01	TriggerAxis(AXIS_X)					
2	00 02	ActivationAxis(AXIS_Y)					

### 7.3.5 Set the Synchronization Action

```
eRET ETM_SET_ACTION(HANDLE hEtm, BYTE cardNo, BYTE
activationAxis, BYTE nDRV, BYTE nLATCH, BYTE nPRESET,
BYTE nOUT, BYTE nINT, BYTE isrNoX, BYTE isrNoY, BYTE
isrNoZ, BYTE isrNoU)
```

```
※Δ eRET ETM_MACRO_SET_ACTION (HANDLE hEtm, BYTE cardNo, BYTE
activationAxis, BYTE nDRV, BYTE nLATCH, BYTE nPRESET,
BYTE nOUT, BYTE nINT, BYTE isrNoX, BYTE isrNoY, BYTE
isrNoZ, BYTE isrNoU)
```

**Description:**

Set the action of synchronization motion.

**Category:**

MODBUS sub\_function; RTC, MP and ISR.

**Parameters:**

Paramters	Description
<i>hEtm</i> :	TCP/IP connection handle
<i>cardNo</i> :	1 (ET-M8194H supports only one i-8094H module)
<i>activationAxis</i> :	Set the synchronization axis number(Please refer to Table 3)

***nDRV*:**

It defines the actions that are related with axial driving. Available actions are listed in the following table. Only one driving action can be chosen.

Value	Symbol	Explanation
0		Disable driving action.
1	FDRV+	Activates fixed pulse driving in the + direction. It must set the <i>nPRESET</i> value to be “OPSET” which indicates that ETM_SET_PRESET() function will set the offset value for this FDRV. Therefore, the companion function, ETM_SET_PRESET(), is necessary. However, this command does not take effect if the assigned axes, <i>axis2</i> , are moving.
2	FDRV-	Activates fixed pulse driving in the - direction. It must set the <i>nPRESET</i> value to be “OPSET” which indicates that ETM_SET_PRESET() function will set the offset value for this FDRV. Therefore, the companion function, ETM_SET_PRESET(), is necessary. However, this command does not take effect if the assigned axes, <i>axis2</i> , are moving.

3	CDRV+	Activates continuous pulse driving in the + direction. However, this command does not take effect if the assigned axes, <i>axis2</i> , are moving
4	CDRV-	Activates continuous pulse driving in the - direction. However, this command does not take effect if the assigned axes, <i>axis2</i> , are moving.
5	SSTOP	Stop driving in deceleration
6	ISTOP	Stop driving immediately

**nLATCH:** It defines the actions that is related of latching position. Available actions are listed in the following table. Only one of these actions can be chosen

Value	Symbol	Explanation
0		Disable position latch function
1	LPSAV	Saves the current logical position counter value (LP) in the synchronous buffer register (BR). [LP → LATCH]
2	EPSAV	Saves the current real position counter value (EP) in the synchronous buffer register (BR). [EP → LATCH]

After the event is occurred, the **ETM\_GET\_LATCH()** function can be use to get the latched value, please refer to section 7.3.3.

**nPRESET:** It defines the actions that is related of latching position. Available actions are listed in the following table. Only one of these actions can be chosen.

Value	Symbol	Explanation
0		Disable setting function
1	LPSET	Indicates that a new value for the logical position ( <b>LP</b> ) will be set. The new value will be set by <b>ETM_SET_PRESET()</b> function. [LP ← PRESET]
2	EPSET	Indicates that a new value for the real position ( <b>EP</b> ) will be set. The new value will be set by <b>ETM_SET_PRESET()</b> function. [EP ← PRESET]
3	OPSET	Indicates that a new offset value ( <b>P</b> ) for the fixed pulse driving will be set. The new value will be set by <b>ETM_SET_PRESET()</b> function. [P ← PRESET] <b>This setting is invalid to the Finish-Point of the axes in CONTINUE_MOVE.</b>
4	VLSET	Indicates that a new speed value ( <b>V</b> ) will be set. The new value will be set by <b>ETM_SET_PRESET()</b> function. [V ← PRESET]

Must be used with **ETM\_SET\_PRESET** together, please refer to section 6.3.4.

**nOUT:** setting trigger output, as the following table:

Value	Symbol	Explanation
0		Disable trigger output
1	OUT	Enable trigger output

**Must be used with ETM\_SET\_OUT together, please refer to section 7.3.5.**

**nINT:** setting interrupt function, as the following table:

Value	Symbol	Explanation
0		Disable interrupt function
1	INT	Enable interrupt function

1. It will generate a interrupt for the synchronous action of **axis2**, please write the corresponding number: **isrNoX** 、 **isrNoY** 、 **isrNoZ** 、 **isrNoU**

2. **Must be used with ETM\_ENABLE\_INT together, please refer to section 7.3.6.**

**isrNoX:** ISR1 ~ ISR20 : Specify the interrupt number of **X-axis**.

**0: disable**

**isrNoY:** ISR1 ~ ISR20 : Specify the interrupt number of **Y-axis**.

**0: disable**

**isrNoZ:** ISR1 ~ ISR20 : Specify the interrupt number of **Z-axis**.

**0: disable**

**isrNoU:** ISR1 ~ ISR20 : Specify the interrupt number of **U-axis**.

**0: disable**

**Return:**

0: Success; Others: Fail (Please refer to chapter 2.2)

**Remark:**

The Sub\_function code of ETM\_SET\_ACTION is 0A 98.

The Sub\_function code of ETM\_MACRO\_SET\_ACTION is 0C 98.

**MODBUS example:**

ETM\_SET\_ACTION (hEtm, 1, AXIS\_Y, 0, 2, 4, 0, 0, 0, 0, 0, 0);

// Set the action of synchronization motion is when the IN3 positive

//edge trigger signals received, it will change the velocity and the

//encoder of LATCH.



The MODBUS command is listed as follows:

TID (hex)	PID (hex)	Field Length (hex)	UID (hex)	FC (hex)	St_Addr. (hex)	Word Count (hex)	Byte Count (hex)
00 01	00 00	00 1D	01	10	1F 40	00 0B	16
Register[]		Value (hex)		Remarks			
0		0A 98/0C 98		<i>Sub_function code</i>			
1		00 02		<i>ActivationAxis(Axis_Y)</i>			
2		00 00		<i>nDRV (0 → no driving control)</i>			
3		00 02		<i>nLATCH (2 → will latch EP value)</i>			
4		00 04		<i>nPRESET (4 → set new velocity when SYNC condition is true)</i>			
5		00 00		<i>nOUT (0 → no pulse out)</i>			
6		00 00		<i>nINT (0 → disable)</i>			
7		00 00		<i>isrNoX (It can be any value since nINT is disable.)</i>			
8		00 00		<i>isrNoY (It can be any value since nINT is disable.)</i>			
9		00 00		<i>isrNoZ (It can be any value since nINT is disable.)</i>			
10		00 00		<i>isrNoU (It can be any value since nINT is disable.)</i>			

Related example:

```
//Example1: Set two groups synchronization motion, when the LP value of x
//axis exceeds COMP+(30000), the synchronization motion axis z-axis
//generate an interrupt to call ISR1, and when the LP value of y axis
//exceeds COMP+(35000), the synchronization motion axis u-axis generate
//an interrupt to call ISR2.
```

```
ETM_SET_MAX_V(hEtm, cardNo, AXIS_XYZU, 5000);
// Set the maximum speed of xyzu axes on module 1 to 5K PPS.
ETM_NORMAL_SPEED(hEtm, cardNo, AXIS_XYZU, 0);
// set the speed profile for xyzu axes as symmetric T-curve.
ETM_SET_V(hEtm, cardNo, AXIS_XYZU, 2000);
// set the speed of xyzu axes on module 1 to 2000 PPS.
ETM_SET_A(hEtm, cardNo, AXIS_XYZU, 100000);
// set the acceleration value of xyzu axes to 100K PPS/sec.
ETM_SET_SV(hEtm, cardNo, AXIS_XYZU, 100);
// set the start velocity of xyzu axes to 100 PPS.
ETM_SET_ACTIVATION_FACTORS(hEtm, cardNo, AXIS_XY, 1);
// Set the synchronization conditions of xy axes is P ≥ C+.
ETM_SET_ACTIVATION_AXIS(hEtm, 1, AXIS_X, AXIS_Z);
// Set the synchronization axis of x axis is z axis.
ETM_SET_ACTIVATION_AXIS(hEtm, 1, AXIS_Y, AXIS_U);
```

```

// Set the synchronization axis of y axis is u axis.
ETM_SET_ACTION (hEtm, 1, AXIS_Z, 0, 0, 0, 0, 1, 0, 0, ISR1, 0);
// Set the action of synchronization motion axis z-axis is to generate an
// interrupt to call ISR1.
ETM_SET_ACTION (hEtm, 1, AXIS_U, 0, 0, 0, 0, 1, 0, 0, 0, ISR2);
// Set the action of synchronization motion axis u-axis is to generate an
// interrupt to call ISR2.
ETM_ENABLE_INT(hEtm, cardNo); //Enable interrupt
ETM_SET_COMPARE (hEtm, cardNo, AXIS_X, 0, 0, 30000);
//Set the value of COMP+ is 30000, source reference the LP of x axis.
ETM_SET_COMPARE (hEtm, cardNo, AXIS_Y, 0, 0, 35000);
//Set the value of COMP+ is 35000, source reference the LP of y axis.
ETM_FIXED_MOVE(hEtm, cardNo, AXIS_XY, 42000);
// move 42K Pulses for xy axes on module 1

ISR1:
ETM_MP_ISR_CREATE(hEtm, cardNo, ISR1); // Create ISR1
ETM_MACRO_FIXED_MOVE(hEtm, cardNo, AXIS_Z, 10000);
// move 10K Pulses for z axis on module 1
ETM_MACRO_MP_ISR_CLOSE(hEtm, cardNo); // End ISR1

ISR2:
ETM_MP_ISR_CREATE(hEtm, cardNo, ISR2); // Create ISR2
ETM_MACRO_FIXED_MOVE(hEtm, cardNo, AXIS_U, 10000);
// move 10K Pulses for u axis on module 1
ETM_MACRO_MP_ISR_CLOSE(hEtm, cardNo); // End ISR2

```

### 7.3.6 COMPARE Value Setting

**eRET ETM\_SET\_COMPARE (HANDLE *hEtm*, BYTE *cardNo*, BYTE *axis*, BYTE *nSELECT*, BYTE *nTYPE*, long *data*)**

**※Δ eRET ETM\_MACRO\_SET\_COMPARE (HANDLE *hEtm*, BYTE *cardNo*, BYTE *axis*, BYTE *nSELECT*, BYTE *nTYPE*, long *data*)**

**Description:**

This function sets the values of COMPARE registers. **However, it will disable the software limit setting.**

**Category:**

MODBUS sub\_function; RTC, MP and ISR.

**Parameters:**

Parameters	Description
<i>hEtm</i> :	TCP/IP connection handle
<i>cardNo</i> :	1 (ET-M8194H supports only one i-8094H module)
<i>axis</i> :	Axis or axes (Please refer to Table 3) The axis can be either X, Y, Z or U (1 or 2 or 4 or 8)
<i>nSELECT</i> :	0 → C+ 1 → C-
<i>nTYPE</i> :	0 → Position(P) = LP 1 → Position(P) = EP
<i>data</i> :	Set the COMPARE value (-2,000,000,000 ~ +2,000,000,000).

**Return:**

0: Success; Others: Fail (Please refer to chapter 2.2)

**Remark:**

The Sub\_function code of ETM\_SET\_COMPARE is 0A 70.

The Sub\_function code of ETM\_MACRO\_SET\_COMPARE is 0C 70.

**MODBUS example:**

ETM\_SET\_COMPARE (*hEtm*, *cardNo*, AXIS\_U, 0, 1, 5000);

//Set the comparison function for U-Axis.

//Set the compared source to be EP; and the COMP+ value to 5000.

The MODBUS command is listed as follows:

TID (hex)	PID (hex)	Field Length (hex)	UID (hex)	FC (hex)	St_Addr. (hex)	Word Count (hex)	Byte Count (hex)
00 01	00 00	00 13	01	10	1F 40	00 06	0C
Register[]		Value (hex)		Remarks			
0		0A 70/0C 70		Sub_function code			
1		00 08		Axis (8 → AXIS_U)			
2		00 00		nSELECT			
3		00 01		nTYPE			
4		00 00		MSW of data			
5		13 88		LSW of data (5000 = 0x1388)			

### 7.3.7 Get LATCH Value

**eRET ETM\_GET\_LATCH (HANDLE *hEtm*, BYTE *cardNo*, BYTE *axis*, long\* *LatchValue*)**

**※Δ eRET ETM\_MACRO\_GET\_LATCH (HANDLE *hEtm*, BYTE *cardNo*, BYTE *axis*)**

**eRET ETM\_GET\_LATCH\_4\_AXIS (HANDLE *hEtm*, BYTE *cardNo*, long\* *LatchValueX*, long\* *LatchValueY*, long\* *LatchValueZ*, long\* *LatchValueU*)**

#### Description:

This function gets the values from the LATCH register.

#### Category:

MODBUS table, MODBUS sub\_function; RTC, MP and ISR.

#### Parameters:

Paramters	Description
<i>hEtm</i> :	TCP/IP connection handle
<i>cardNo</i> :	1 (ET-M8194H supports only one i-8094H module)
<i>axis</i> :	Axis or axes (Please refer to Table 3) The axis can be either X, Y, Z or U (1 or 2 or 4 or 8)
<i>LatchValue</i> :	The pointer points to the memory that stores the value of LATCH. (-2,000,000,000 ~ +2,000,000,000).
<i>LatchValueX</i> :	The pointer points to the memory that stores the value of LATCH. (-2,000,000,000 ~ +2,000,000,000) of x axis.
<i>LatchValueY</i> :	The pointer points to the memory that stores the value of LATCH. (-2,000,000,000 ~ +2,000,000,000) of y axis.
<i>LatchValueZ</i> :	The pointer points to the memory that stores the value of LATCH. (-2,000,000,000 ~ +2,000,000,000) of z axis.
<i>LatchValueU</i> :	The pointer points to the memory that stores the value of LATCH. (-2,000,000,000 ~ +2,000,000,000) of u axis.

#### Return:

0: Success; Others: Fail (Please refer to chapter 2.2)

**MODBUS example:**

- **Method 1:** It can get latched values directly.

The latched values are long type values. Therefore, polling the latched values must start at the MSW of each axis's MSW.

STOP status	Address	Remarks
X_LATCH_MSW	62 (0x3E)	MSW of X_LATCH
X_LATCH_LSW	63 (0x3F)	LSW of X_LATCH
Y_LATCH_MSW	64 (0x40)	MSW of Y_LATCH
Y_LATCH_LSW	65 (0x41)	LSW of Y_LATCH
Z_LATCH_MSW	66 (0x42)	MSW of Z_LATCH
Z_LATCH_LSW	67 (0x43)	LSW of Z_LATCH
U_LATCH_MSW	68 (0x44)	MSW of U_LATCH
U_LATCH_LSW	69 (0x45)	LSW of U_LATCH

```
long LATCH_Y;
ETM_GET_LATCH (hEtm, 1, AXIS_Y, &LATCH_Y);
```

The MODBUS command is listed as follows:

TID (hex)	PID (hex)	Field Length (hex)	UID (hex)	FC (hex)	St_Addr. (hex)	Word Count (hex)
00 01	00 00	00 06	01	04	00 40	00 02

The response via MODBUS may be:

TID (hex)	PID (hex)	Field Length (hex)	UID (hex)	FC (hex)	Byte Count (hex)	MSW of Y_LATCH (Reg_0)	LSW of Y_LATCH (Reg_1)
00 01	00 00	00 07	01	04	04	00 00	03 E8

```
LATCH_Y = Register[0];
LATCH_Y = (long) (((LATCH_Y << 16) & 0xffff0000) | (Register[1] & 0xffff) );
```

- Method 2: It can be used inside a MP program.

For this case, users do not actually want to get the current latched values. The getting latched values will be executed only when the MP is called. Therefore, use **FC = 16** to write this command inside a MP. This kind of usage often has **ETM\_MACRO\_SET\_RVAR()** followed to save the return latched value. Please refer to MP related explanation literature.

```
ETM_MACRO_GET_LATCH (hEtm, 1, AXIS_Y);
//Get the latched value which is from Y-axis of card 1.
```

The MODBUS command is listed as follows:

TID (hex)	PID (hex)	Field Length (hex)	UID (hex)	FC (hex)	St_Addr. (hex)	Word Count (hex)	Byte Count (hex)
00 01	00 00	00 0B	01	10	1F 40	00 02	04
Register[]		Value (hex)		Remarks			
0		0C 71		<i>Sub_function code</i>			
1		00 02		<i>axis</i>			

### 7.3.8 PRESET Data for Synchronous Action Setting

**eRET** ETM\_SET\_PRESET (**HANDLE** *hEtm*, **BYTE** *cardNo*, **BYTE** *axis*, **long** *data*)

※**Δ eRET** ETM\_MACRO\_SET\_PRESET (**HANDLE** *hEtm*, **BYTE** *cardNo*, **BYTE** *axis*, **long** *data*)

**Description:**

This function sets the PRESET value for synchronous action. The synchronous action axis can not be set individually.

**Category:**

MODBUS sub\_function; RTC, MP and ISR.

**Parameters:**

Paramters	Description
<i>hEtm</i> :	TCP/IP connection handle
<i>cardNo</i> :	1 (ET-M8194H supports only one i-8094H module)
<i>axis</i> :	The number of synchronization motion axis, this axis must be assined as the <b>axis2</b> parameter of ETM_SYNC_ACTION( ).
<i>data</i> :	LP: (-2,000,000,000 ~ +2,000,000,000) EP: (-2,000,000,000 ~ +2,000,000,000) P : (-2,000,000,000 ~ +2,000,000,000) V : Please refer to description of ETM_SET_MAX_V. If there are more than two synchronous action axes, please set ETM_SET_MAX_V to be same value.

**Return:**

0: Success; Others: Fail (Please refer to chapter 2.2)

**Remark:**

The Sub\_function code of ETM\_SET\_PRESET is 0A 72.

The Sub\_function code of ETM\_MACRO\_SET\_PRESET is 0C 72.

**MODBUS example:**

If the SYNC action is set to change velocity, then following statement will change the velocity of AXIS\_U to 100 PPS when the condition is true.

```
ETM_SET_PRESET (hEtm, cardNo, AXIS_U, 100);
```



The MODBUS command is listed as follows:

TID (hex)	PID (hex)	Field Length (hex)	UID (hex)	FC (hex)	St_Addr. (hex)	Word Count (hex)	Byte Count (hex)
00 01	00 00	00 0F	01	10	1F 40	00 04	08
Register[]		Value (hex)		Remarks			
0		0A 72/0C 72		<i>Sub_function code</i>			
1		00 08		<i>Axis (8 → AXIS_U)</i>			
2		00 00		<i>MSW of data</i>			
3		00 64		<i>LSW of data (100 = 0x64)</i>			

### 7.3.9 OUT Data Setting

**eRET ETM\_SET\_OUT (HANDLE hEtm, BYTE cardNo, BYTE axis, BYTE outEdge, BYTE PulseWidth)**

**※Δ eRET ETM\_MACRO\_SET\_OUT (HANDLE hEtm, BYTE cardNo, BYTE axis, BYTE outEdge, BYTE PulseWidth)**

**Description:**

This function configures the output pulse settings.

**Category:**

MODBUS sub\_function; RTC, MP and ISR.

**Parameters:**

Paramters	Description
<i>hEtm:</i>	TCP/IP connection handle
<i>cardNo:</i>	1 (ET-M8194H supports only one i-8094H module)
<i>axis:</i>	Axis or axes (Please refer to Table 3), <b>currently only support Axes X &amp; Y</b>
<i>outEdge:</i>	Output active logic: 0 = low active; 1 = high active
<i>PulseWidth:</i>	Output pulse width 0 = 10 uSec 1 = 20 uSec 2 = 100 uSec 3 = 200 uSec 4 = 1,000 uSec 5 = 2,000 uSec 6 = 10,000 uSec 7 = 20,000 uSec

**Return:**

0: Success; Others: Fail (Please refer to chapter 2.2)

**Remark:**

The Sub\_function code of ETM\_SET\_OUT is 0A 73.

The Sub\_function code of ETM\_MACRO\_SET\_OUT is 0C 73.

**MODBUS example:**

If the SYNC action enables the digital OUT function, then following statement can define the waveform of digital output that includes the level and the pulse width.

ETM\_SET\_OUT (hEtm, 1, AXIS\_U, 1, 0);

The MODBUS command is listed as follows:

TID (hex)	PID (hex)	Field Length (hex)	UID (hex)	FC (hex)	St_Addr. (hex)	Word Count (hex)	Byte Count (hex)
00 01	00 00	00 0F	01	10	1F 40	00 04	08
Register[]		Value (hex)		Remarks			
0		0A 73/0C 73		<i>Sub_function code</i>			
1		00 08		<i>Axis (8 → AXIS_U)</i>			
2		00 01		<i>outEdge</i>			
3		00 00		<i>PulseWidth</i>			

### 7.3.10 Enable Interrupt Functions of i-8094H

<b>eRET</b> ETM_ENABLE_INT ( <b>HANDLE</b> <i>hEtm</i> , <b>BYTE</b> <i>cardNo</i> )
✘ <b>eRET</b> ETM_MACRO_ENABLE_INT ( <b>HANDLE</b> <i>hEtm</i> , <b>BYTE</b> <i>cardNo</i> )

**Description:**

This function enables the interrupt function of the motion chip inside the i-8094H.

**Category:**

MODBUS sub\_function; RTC, MP.

**Parameters:**

Paramters	Description
<i>hEtm</i> :	TCP/IP connection handle
<i>cardNo</i> :	1 (ET-M8194H supports only one i-8094H module)

**Return:**

0: Success; Others: Fail (Please refer to chapter 2.2)

**Remark:**

The Sub\_function code of ETM\_ENABLE\_INT is 0A AA.

The Sub\_function code of ETM\_MACRO\_ENABLE\_INT is 0C AA.

**MODBUS example:**

ETM\_ENABLE\_INT (*hEtm*, 1);

*//Enable the interrupt function for module 1.*

The MODBUS command is listed as follows:

TID (hex)	PID (hex)	Field Length (hex)	UID (hex)	FC (hex)	St_Addr. (hex)	Word Count (hex)	Byte Count (hex)
00 01	00 00	00 09	01	10	1F 40	00 01	02
Register[]		Value (hex)		Remarks			
0		0A AA/0C AA		Sub_function code			

### 7.3.11 Disable Interrupt Functions of i-8094H

```
eRET ETM_DISABLE_INT (HANDLE hEtm, BYTE cardNo)
✘ eRET ETM_MACRO_DISABLE_INT (HANDLE hEtm, BYTE cardNo)
```

**Description:**

This function disables the interrupt function of the motion chip inside the i-8094H.

**Category:**

MODBUS sub\_function; RTC, MP.

**Parameters:**

Paramters	Description
<i>hEtm</i> :	TCP/IP connection handle
<i>cardNo</i> :	1 (ET-M8194H supports only one i-8094H module)

**Return:**

0: Success; Others: Fail (Please refer to chapter 2.2)

**Remark:**

The Sub\_function code of ETM\_DISABLE\_INT is 0A AB.  
 The Sub\_function code of ETM\_MACRO\_DISABLE\_INT is 0C AB.

**MODBUS example:**

```
ETM_DISABLE_INT (hEtm, 1);
//Disable the interrupt function for module 1.
```

The MODBUS command is listed as follows:

TID (hex)	PID (hex)	Field Length (hex)	UID (hex)	FC (hex)	St_Addr. (hex)	Word Count (hex)	Byte Count (hex)
00 01	00 00	00 09	01	10	1F 40	00 01	02
Register[]		Value (hex)		Remarks			
0		0A AB/0C AB		Sub_function code			

### 7.3.12 Set Interrupt Factor of i-8094H

**eRET ETM\_INTFACTOR\_ENABLE (HANDLE *hEtm*, BYTE *cardNo*, BYTE *axis*, BYTE *nINT*, BYTE *isrNo*)**

**※Δ eRET ETM\_MACRO\_INTFACTOR\_ENABLE (HANDLE *hEtm*, BYTE *cardNo*, BYTE *axis*, BYTE *nINT*, BYTE *isrNo*)**

**Description:**

This function sets the condition factor of interrupt of the motion chip.

**Category:**

MODBUS sub\_function; RTC, MP, ISR.

**Parameters:**

Paramters	Description
<i>hEtm</i> :	TCP/IP connection handle
<i>cardNo</i> :	1 (ET-M8194H supports only one i-8094H module)
<i>axis</i> :	Axis or axes (Please refer to Table 3) The axis can be either X, Y, Z or U (1 or 2 or 4 or 8)

*nINT*: condition factors of interrupt, please refer to the following table

**Table 10: Motion chip interrupt factor table**

nINT	Symbol	Description
0	PULSE	Interrupt occurs when pulse is up
1	P>=C-	Interrupt occurs when the value of logical / real position counter is larger than or equal to that of COMP- register. Please refer to ETM_SET_COMPARE() (6.3.2)
2	P<C-	Interrupt occurs when the value of logical / real position counter is smaller than that of COMP- register. Please refer to ETM_SET_COMPARE() (6.3.2)
3	P<C+	Interrupt occurs when the value of logical / real position counter is smaller than that of COMP+ register. Please refer to ETM_SET_COMPARE() (6.3.2)
4	P>=C+	Interrupt occurs when the value of logical / real position counter is larger than or equal to that of COMP+ register. Please refer to ETM_SET_COMPARE() (6.3.2)
5	C-END	Interrupt occurs at the end of the constant speed drive or completion of Acceleration Offset Pulse output
6	C-STA	Interrupt occurs at the start of the constant speed drive or begin of Acceleration Offset Pulse output
7	D-END	Interrupt occurs when the driving is finished

**isrNo:**           ISR1 ~ ISR20 : Specify the number of interrupt service.

**Return:**

0: Success; Others: Fail (Please refer to chapter 2.2)

**Remark:**

This function is conflict with ETM\_SET\_SLMT(2.10).

The Sub\_function code of ETM\_INTFACTOR\_ENABLE is 0A AC.

The Sub\_function code of ETM\_MACRO\_INTFACTOR\_ENABLE is 0C AC.

**MODBUS example:**

This function assigns an ISRn to process an interrupt that happens at a specified axis.

**ETM\_INTFACTOR\_ENABLE (hEtm, 1, AXIS\_X, 4, ISR1);//When the position counter of x axis exceeds C+, then call ISR1.**

The MODBUS command is listed as follows:

TID (hex)	PID (hex)	Field Length (hex)	UID (hex)	FC (hex)	St_Addr. (hex)	Word Count (hex)	Byte Count (hex)
00 01	00 00	00 0F	01	10	1F 40	00 04	08
Register[]		Value (hex)		Remarks			
0		0A AC/0C AC		Sub_function code			
1		00 01		axis (1 → AXIS_X)			
2		00 04		nINT			
3		00 01		isrNo (ISR1 = 1)			

**Related example:**

**//Example1: Using call the ISR to set multi-group compare.**

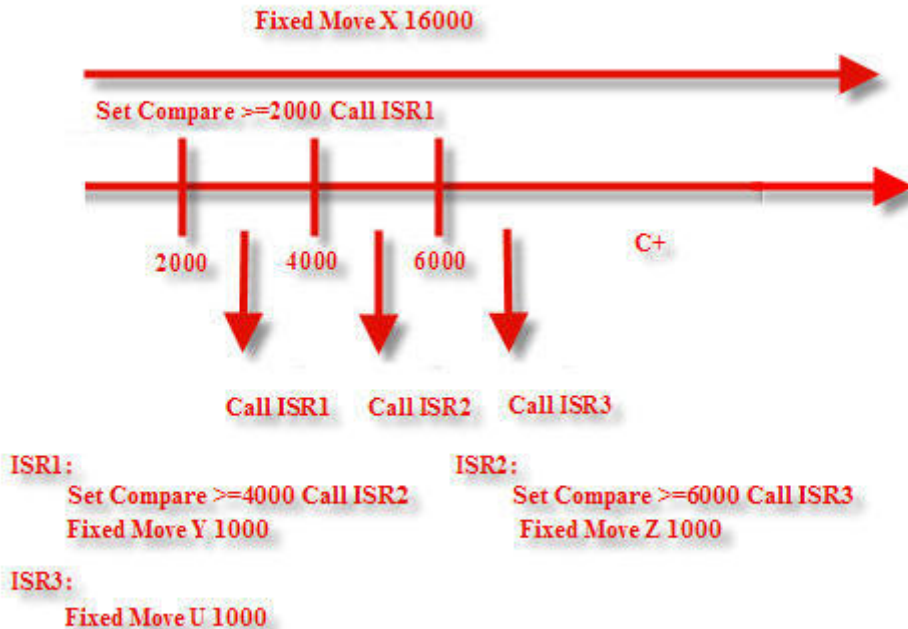

```
ETM_SET_MAX_V(hEtm, cardNo, AXIS_XYZU, 5000);
// Set the maximum speed of xyzu axes on module 1 to 5K PPS.
ETM_NORMAL_SPEED(hEtm, cardNo, AXIS_XYZU, 0);
// set the speed profile for xyzu axes as symmetric T-curve.
ETM_SET_V(hEtm, cardNo, AXIS_XYZU, 2000);
// set the speed of xyzu axes on module 1 to 2000 PPS.
ETM_SET_A(hEtm, cardNo, AXIS_XYZU, 100000);
// set the acceleration value of xyzu axes to 100K PPS/S.
ETM_SET_SV(hEtm, cardNo, AXIS_XYZU, 100);
// set the start velocity of xyzu axes to 100 PPS.
ETM_SET_COMPARE(hEtm, cardNo, AXIS_X, 0, 0, 2000);
//Set the value of COMP+ is 2000, source reference the LP of x axis.
ETM_INTFACTOR_ENABLE (hEtm, 1, AXIS_X, 4, ISR1);
//When the LP value of x axis exceeds C+(2000), then call ISR1.
ETM_ENABLE_INT (hEtm, 1); //Enable interrupt
ETM_FIXED_MOVE(hEtm, cardNo, AXIS_X, 16000);
// move 16K Pulses for x axis on module 1
```

```
ISR1:
ETM_MP_ISR_CREATE(hEtm, cardNo, ISR1); //Create ISR1
ETM_MACRO_SET_COMPARE(hEtm, cardNo, AXIS_X, 0, 0, 4000);
//Set the value of COMP+ is 4000, source reference the LP of x axis.
ETM_MACRO_INTFACTOR_ENABLE (hEtm, 1, AXIS_X, 4, ISR2);
```



```
//When the LP value of x axis exceeds C+(4000), then call ISR2.  
ETM_MACRO_FIXED_MOVE(hEtm, cardNo, AXIS_Y, 1000);  
// move 1000 Pulses for y axis on module 1  
ETM_MACRO_MP_ISR_CLOSE(hEtm, cardNo); // End ISR1
```

ISR2:

```
ETM_MP_ISR_CREATE(hEtm, cardNo, ISR2); //Create ISR2  
ETM_MACRO_SET_COMPARE(hEtm, cardNo, AXIS_X, 0, 0, 6000);  
//Set the value of COMP+ is 6000, source reference the LP of x axis.  
ETM_MACRO_INTFACTOR_ENABLE (hEtm, 1, AXIS_X, 4, ISR3);  
//When the LP value of x axis exceeds C+(6000), then call ISR3.  
ETM_MACRO_FIXED_MOVE(hEtm, cardNo, AXIS_Z, 1000);  
// move 1000 Pulses for z axis on module 1  
ETM_MACRO_MP_ISR_CLOSE(hEtm, cardNo); // End ISR2
```

ISR3:

```
ETM_MP_ISR_CREATE(hEtm, cardNo, ISR3); //Create ISR3  
ETM_MACRO_FIXED_MOVE(hEtm, cardNo, AXIS_U, 1000);  
// move 1000 Pulses for u axis on module 1  
ETM_MACRO_MP_ISR_CLOSE(hEtm, cardNo); // End ISR3
```

### 7.3.13 Clear Interrupt Factor of i-8094H

**eRET ETM\_INTFACTOR\_DISABLE (HANDLE *hEtm*, BYTE *cardNo*, BYTE *axis*, BYTE *nINT*)**

**※Δ eRET ETM\_MACRO\_INTFACTOR\_DISABLE (HANDLE *hEtm*, BYTE *cardNo*, BYTE *axis*, BYTE *nINT*)**

**Description:**

This function disables the condition factor interrupt of the motion chip.

**Category:**

MODBUS sub\_function; RTC, MP, ISR.

**Parameters:**

Parameters	Description
<i>hEtm</i> :	TCP/IP connection handle
<i>cardNo</i> :	1 (ET-M8194H supports only one i-8094H module)
<i>axis</i> :	Axis or axes (Please refer to Table 3) The axis can be either X, Y, Z or U (1 or 2 or 4 or 8)

*nINT*: condition factors of interrupt, please refer to the following table

Number	Symbol	Description
0	PULSE	Interrupt occurs when pulse is up
1	P>=C-	Interrupt occurs when the value of logical / real position counter is larger than or equal to that of COMP- register.
2	P<C-	Interrupt occurs when the value of logical / real position counter is smaller than that of COMP- register
3	P<C+	Interrupt occurs when the value of logical / real position counter is smaller than that of COMP+ register.
4	P>=C+	Interrupt occurs when the value of logical / real position counter is larger than or equal to that of COMP+ register.
5	C-END	Interrupt occurs at the end of the constant speed drive or completion of Acceleration Offset Pulse output
6	C-STA	Interrupt occurs at the start of the constant speed drive or begin of Acceleration Offset Pulse output
7	D-END	Interrupt occurs when the driving is finished
10	DISABLE ALL	Disable all the trigger conditions interrupt factor

**Return:**

0: Success; Others: Fail (Please refer to chapter 2.2)

**Remark:**

The Sub\_function code of ETM\_INTFACTOR\_DISABLE is 0A AD.  
The Sub\_function code of ETM\_MACRO\_INTFACTOR\_DISABLE is 0C AD.

**MODBUS example:**

```
ETM_INTFACTOR_DISABLE (hEtm, 1, AXIS_XYZU, 4);  
// Disable the interrupt factors of Module 1  
// 4 : Interrupt occurs when the value of logic / real position counter  
// is larger than or equal to that of COMP+ register.
```

The MODBUS command is listed as follows:

TID (hex)	PID (hex)	Field Length (hex)	UID (hex)	FC (hex)	St_Addr. (hex)	Word Count (hex)	Byte Count (hex)
00 01	00 00	00 0D	01	10	1F 40	00 03	06
Register[]		Value (hex)		Remarks			
0		0A AD/0C AD		Sub_function code			
1		00 0F		axis (0xF → AXIS_XYZU)			
2		00 04		nINT			

**Related example:**

```
ETM_INTFACTOR_DISABLE(hEtm, 1, AXIS_XYZU, 1);  
ETM_INTFACTOR_DISABLE(hEtm, 1, AXIS_XYZU, 2);  
ETM_INTFACTOR_DISABLE(hEtm, 1, AXIS_XYZU, 3);  
ETM_INTFACTOR_DISABLE(hEtm, 1, AXIS_XYZU, 4);  
// Disable the interrupt factors of Module 1
```

## 7.4 Continuous Interpolation

### 7.4.1 2-Axis Rectangular Motion

<b>eRET</b>	<b>ETM_RECTANGLE</b> ( <b>HANDLE</b> <i>hEtm</i> , <b>BYTE</b> <i>cardNo</i> , <b>BYTE</b> <i>axis1</i> , <b>BYTE</b> <i>axis2</i> , <b>BYTE</b> <i>nAcc</i> , <b>BYTE</b> <i>Sp</i> , <b>BYTE</b> <i>nDir</i> , <b>long</b> <i>Lp</i> , <b>long</b> <i>Wp</i> , <b>long</b> <i>Rp</i> , <b>DWORD</b> <i>RSV</i> , <b>DWORD</b> <i>RV</i> , <b>DWORD</b> <i>RA</i> , <b>DWORD</b> <i>RD</i> )
<b>※ eRET</b>	<b>ETM_MACRO_RECTANGLE</b> ( <b>HANDLE</b> <i>hEtm</i> , <b>BYTE</b> <i>cardNo</i> , <b>BYTE</b> <i>axis1</i> , <b>BYTE</b> <i>axis2</i> , <b>BYTE</b> <i>nAcc</i> , <b>BYTE</b> <i>Sp</i> , <b>BYTE</b> <i>nDir</i> , <b>long</b> <i>Lp</i> , <b>long</b> <i>Wp</i> , <b>long</b> <i>Rp</i> , <b>DWORD</b> <i>RSV</i> , <b>DWORD</b> <i>RV</i> , <b>DWORD</b> <i>RA</i> , <b>DWORD</b> <i>RD</i> )

#### Description:

Continuous interpolation will be performed to create a rectangular motion, which is formed by 4 lines and 4 arcs. The length of each side can be changed. The radius of each arc is of the same value and it can also be changed. The deceleration point will be calculated automatically. This is a command that appears in various motion applications.

#### Category:

MODBUS sub\_function; RTC and MP.

#### Parameters:

Paramters	Description
<i>hEtm</i> :	TCP/IP connection handle
<i>cardNo</i> :	1 (ET-M8194H supports only one i-8094H module)
<i>axis1</i> :	The first axis (axis 1). Please refer to Table 3. The axis can be either X, Y, Z or U (1 or 2 or 4 or 8).
<i>axis2</i> :	The second axis (axis 2). Please refer to Table 3. The axis can be either X, Y, Z or U (1 or 2 or 4 or 8).
<i>nAcc</i> :	0 → constant vector speed interpolation mode 1 → symmetric T-curve Acc/Dec interpolation mod
<i>Sp</i> :	Start point 0 ~ 7. (Sp0 ~ Sp7 are defined in the following.)
<i>nDir</i> :	Direction of movement 0: CCW; 1: CW
<i>Lp</i> :	Length in Pulses (1 ~ 2,000,000,00)
<i>Wp</i> :	Width in Pulses (1 ~ 2,000,000,00)
<i>Rp</i> :	Radius of each in pulses (1 ~ 2,000,000,00)
<i>RSV</i> :	Starting speed (in PPS)
<i>RV</i> :	Vector speed (in PPS)
<i>RA</i> :	Acceleration (PPS/sec)
<i>RD</i> :	Deceleration of the last segment (in PPS/sec)

**Return:**

0: Success; Others: Fail (Please refer to chapter 2.2)  
Use the ETM\_GET\_ERROR\_CODE() function to identify the error.

**Remark:**

The Sub\_function code of ETM\_RECTANGLE is 0A 78.  
The Sub\_function code of ETM\_MACRO\_RECTANGLE is 0C 78.

**MODBUS example:**

ETM\_RECTANGLE (hEtm, 1, AXIS\_X, AXIS\_Y, 1, 0, 0, 20000, 10000, 1000, 1000, 10000, 5000, 5000);  
//execute a rectangular motion on XY plane, will auto-calculate  
//deceleration point.

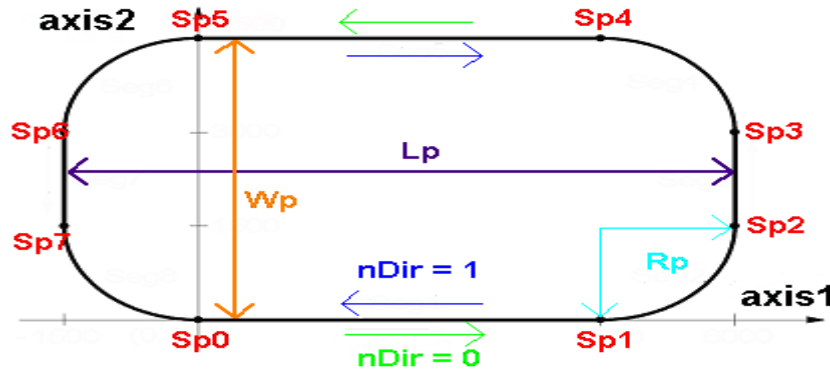

The MODBUS command is listed as follows:

TID (hex)	PID (hex)	Field Length (hex)	UID (hex)	FC (hex)	St_Addr. (hex)	Word Count (hex)	Byte Count (hex)
00 01	00 00	00 2F	01	10	1F 40	00 14	28
Register[]	Value (hex)	Remarks					
0	0A 78/0C 78	Sub_function code					
1	00 01	axis1 (1 → AXIS_X)					
2	00 02	axis2 (2 → AXIS_Y)					
3	00 01	nAcc (velocity profile)					
4	00 00	Sp (choose the start point from 0~7 )					
5	00 00	nDir (set the direction to be CCW)					
6	00 00	MSW of Lp (length of the rectangle)					
7	4E 20	LSW of Lp (20000 = 0x4E20)					
8	00 00	MSW of Wp (width of the rectangle)					
9	27 10	LSW of Wp (10000 = 0x2710)					
10	00 00	MSW of Rp (set the corner radius value)					
11	03 E8	LSW of Rp (1000 = 0x3E8)					
12	00 00	MSW of RSV (define start velocity)					

13	03 E8	LSW of RSV (1000 = 0x3E8)
14	00 00	MSW of RV (define velocity)
15	27 10	LSW of RV (10000 = 0x2710)
16	00 00	MSW of RA (define acc value)
17	13 88	LSW of RA (5000 = 1388)
18	00 00	MSW of RD (define dec value)
19	13 88	LSW of RD (5000 = 1388)

## 7.4.2 Set the Speed of 2-Axis Continuous Linear Interpolation

<b>eRET ETM_LINE_2D_INITIAL (HANDLE <i>hEtm</i>, BYTE <i>cardNo</i>, BYTE <i>axis1</i>, BYTE <i>axis2</i>, DWORD <i>VSV</i>, DWORD <i>VV</i>, DWORD <i>VA</i>)</b>
<b>※ eRET ETM_MACRO_LINE_2D_INITIAL (HANDLE <i>hEtm</i>, BYTE <i>cardNo</i>, BYTE <i>axis1</i>, BYTE <i>axis2</i>, DWORD <i>VSV</i>, DWORD <i>VV</i>, DWORD <i>VA</i>)</b>

**Description:**

This function sets the necessary parameters for a 2-axis continuous linear interpolation using symmetric T-curve speed profile.

**Category:**

MODBUS sub\_function; RTC and MP.

**Parameters:**

Paramters	Description
<i>hEtm</i> :	TCP/IP connection handle
<i>cardNo</i> :	1 (ET-M8194H supports only one i-8094H module)
<i>axis1</i> :	The first axis (axis 1). Please refer to Table 3. The axis can be either X, Y, Z or U (1 or 2 or 4 or 8).
<i>axis2</i> :	The second axis (axis 2). Please refer to Table 3. The axis can be either X, Y, Z or U (1 or 2 or 4 or 8).
<i>VSV</i> :	Starting speed (in PPS)
<i>VV</i> :	Vector speed (in PPS)
<i>VA</i> :	Vector acceleration (PPS/sec)

**Return:**

0: Success; Others: Fail (Please refer to chapter 2.2)  
 Use the ETM\_GET\_ERROR\_CODE() function to identify the error.

**Remark:**

The Sub\_function code of ETM\_LINE\_2D\_INITIAL is 0A 7C.  
 The Sub\_function code of ETM\_MACRO\_LINE\_2D\_INITIAL is 0C 7C.

**MODBUS example:**

```
ETM_LINE_2D_INITIAL (hEtm, 1, AXIS_X, AXIS_Y, 300, 18000, 500000);
//This function should be defined before the ETM_LINE_2D_CONTINUE()
//function is used. Please refer to the example of this function.
```

The MODBUS command is listed as follows:

TID (hex)	PID (hex)	Field Length (hex)	UID (hex)	FC (hex)	St_Addr. (hex)	Word Count (hex)	Byte Count (hex)
00 01	00 00	00 19	01	10	1F 40	00 09	12
Register[]		Value (hex)		Remarks			
0		0A 7C/0C 7C		Sub_funciton code			
1		00 01		axis1 (1 → AXIS_X)			
2		00 02		axis2 (2 → AXIS_Y)			
3		00 00		MSW of VSV			
4		01 2C		LSW of VSV (300 = 0x12C)			
5		00 00		MSW of VV			
6		46 50		LSW of VV (18000 = 0x4650)			
7		00 07		MSW of VA			
8		A1 20		LSW of VA (500000 = 0x0007A120)			



### 7.4.3 Execute a 2-Axis Continuous Linear Interpolation (Relative Distance)

<b>eRET</b> ETM_LINE_2D_CONTINUE ( <b>HANDLE</b> <i>hEtm</i> , <b>BYTE</b> <i>cardNo</i> , <b>BYTE</b> <i>nType</i> , <b>long</b> <i>fp1</i> , <b>long</b> <i>fp2</i> )
<b>※ eRET</b> ETM_MACRO_LINE_2D_CONTINUE ( <b>HANDLE</b> <i>hEtm</i> , <b>BYTE</b> <i>cardNo</i> , <b>BYTE</b> <i>nType</i> , <b>long</b> <i>fp1</i> , <b>long</b> <i>fp2</i> )

**Description:**

This function executes a 2-axis continuous linear interpolation.

**Category:**

MODBUS sub\_function; RTC and MP.

**Parameters:**

Parameters	Description
<i>hEtm</i> :	TCP/IP connection handle
<i>cardNo</i> :	1 (ET-M8194H supports only one i-8094H module)
<i>nType</i> :	0 → 2-axis linear continuous interpolation 1 → end of 2-axis linear continuous interpolation
<i>fp1</i> :	The assigned number of pulses for the axis 1 (in Pulses) (-2,000,000,000 ~ +2,000,000,000)
<i>fp2</i> :	The assigned number of pulses for the axis 2 (in Pulses) (-2,000,000,000 ~ +2,000,000,000)

**Return:**

0: Success; Others: Fail (Please refer to chapter 2.2)

Use the ETM\_GET\_ERROR\_CODE() function to identify the error.

**Remark:**

The Sub\_function code of ETM\_LINE\_2D\_CONTINUE is 0A 7E.

The Sub\_function code of ETM\_MACRO\_LINE\_2D\_CONTINUE is 0C 7E.

**MODBUS example:**

ETM\_LINE\_2D\_CONTINUE (hEtm, 1, 0, 100, 100);

//execute X, Y 2-axis linear continuous interpolation on module 1

The MODBUS command is listed as follows:

TID (hex)	PID (hex)	Field Length (hex)	UID (hex)	FC (hex)	St_Addr. (hex)	Word Count (hex)	Byte Count (hex)
00 01	00 00	00 13	01	10	1F 40	00 06	0C
Register[]	Value (hex)	Remarks					
0	0A 7E/0C 7E	Sub_functon code					
1	00 00	nType					
2	00 00	MSW of fp1					
3	00 64	LSW of fp1 (100 = 0x64)					
4	00 00	MSW of fp2					
5	00 64	LSW of fp2					

Related example:

```

BYTE cardNo=1;
unsigned short sv=300; //Set the vector start velocity is 300 PPS ◦
unsigned short v=18000; //Set the vector velocity is 18000 PPS ◦
unsigned long a=500000; //Set the vector acceleration is 500K PPS/s ◦
unsigned short loop1;
ETM_SET_MAX_V(hEtm, cardNo, AXIS_XYZU, 160000L);
// Set the maximum speed of xyzu axes on module 1 to 160K PPS.
ETM_LINE_2D_INITIAL(hEtm, cardNo, AXIS_X, AXIS_Y, sv, v, a);
for (loop1 = 0; loop1 < 10000; loop1++)
{
    ETM_LINE_2D_CONTINUE (hEtm, cardNo, 0, 100, 100);
    ETM_LINE_2D_CONTINUE (hEtm, cardNo, 0, -100, -100);
    //execute X, Y 2-axis linear continuous interpolation on module 1
}
ETM_LINE_2D_CONTINUE (hEtm, cardNo, 1, 100, 100);
//end X, Y 2-axis linear continuous interpolation on module 1

```

## 7.4.4 Execute a 2-Axis Continuous Linear Interpolation (Absolut Position)

<b>eRET</b> ETM_ABS_LINE_2D_CONTINUE ( <b>HANDLE</b> <i>hEtm</i> , <b>BYTE</b> <i>cardNo</i> , <b>BYTE</b> <i>nType</i> , <b>long</b> <i>fp1</i> , <b>long</b> <i>fp2</i> )
※ <b>eRET</b> ETM_ABS_MACRO_LINE_2D_CONTINUE ( <b>HANDLE</b> <i>hEtm</i> , <b>BYTE</b> <i>cardNo</i> , <b>BYTE</b> <i>nType</i> , <b>long</b> <i>fp1</i> , <b>long</b> <i>fp2</i> )

### Description:

This function executes a 2-axis continuous linear interpolation motion to the specified target position.

### Category:

MODBUS sub\_function; RTC and MP.

### Parameters:

Parameters	Description
<i>hEtm</i> :	TCP/IP connection handle
<i>cardNo</i> :	1 (ET-M8194H supports only one i-8094H module)
<i>nType</i> :	0 → 2-axis linear continuous interpolation 1 → end of 2-axis linear continuous interpolation
<i>fp1</i> :	Absolute position of axis 1 (in Pulses) (-2,000,000,000 ~ +2,000,000,000)
<i>fp2</i> :	Absolute position of axis 2 (in Pulses) (-2,000,000,000 ~ +2,000,000,000)

### Return:

0: Success; Others: Fail (Please refer to chapter 2.2)  
Use the ETM\_GET\_ERROR\_CODE() function to identify the error.

### Remark:

The Sub\_function code of ETM\_ABS\_LINE\_2D\_CONTINUE is 0x0AFB.  
The Sub\_function code of ETM\_ABS\_MACRO\_LINE\_2D\_CONTINUE is 0x0CFB.

### MODBUS example:

```
ETM_ABS_LINE_2D_CONTINUE (hEtm, 1, 0, 100, 100);  
//execute X, Y 2-axis linear continuous interpolation on module 1
```

The MODBUS command is listed as follows:

TID (hex)	PID (hex)	Field Length (hex)	UID (hex)	FC (hex)	St_Addr. (hex)	Word Count (hex)	Byte Count (hex)
00 01	00 00	00 13	01	10	1F 40	00 06	0C
Register[]	Value (hex)	Remarks					
0	0A FB/0C FB	<i>Sub_functon code</i>					
1	00 00	<i>nType</i>					
2	00 00	<i>MSW of fp1</i>					
3	00 64	<i>LSW of fp1 (100 = 0x64)</i>					
4	00 00	<i>MSW of fp2</i>					
5	00 64	<i>LSW of fp2</i>					

Related example:

```

BYTE cardNo=1;
unsigned short sv=300; //Set the vector start velocity is 300 PPS ◦
unsigned short v=18000; //Set the vector velocity is 18000 PPS ◦
unsigned long a=500000; //Set the vector acceleration is 500K PPS/s ◦
unsigned short loop1;
ETM_SET_MAX_V(hEtm, cardNo, AXIS_XYZU, 160000L);
// Set the maximum speed of xyzu axes on module 1 to 160K PPS.
ETM_LINE_2D_INITIAL(hEtm, cardNo, AXIS_X, AXIS_Y, sv, v, a);
for (loop1 = 0; loop1 < 10000; loop1++)
{
    ETM_ABS_LINE_2D_CONTINUE (hEtm, cardNo, 0, 100, 100);
    ETM_ABS_LINE_2D_CONTINUE (hEtm, cardNo, 0, -100, -100);
    //execute X, Y 2-axis linear continuous interpolation on module 1
}
ETM_ABS_LINE_2D_CONTINUE (hEtm, cardNo, 1, 100, 100);
//end X, Y 2-axis linear continuous interpolation on module 1

```

## 7.4.5 Set the Speed of 3-Axis Continuous Linear Interpolation

<b>eRET</b> ETM_LINE_3D_INITIAL ( <b>HANDLE</b> <i>hEtm</i> , <b>BYTE</b> <i>cardNo</i> , <b>BYTE</b> <i>axis1</i> , <b>BYTE</b> <i>axis2</i> , <b>BYTE</b> <i>axis3</i> , <b>DWORD</b> <i>VSV</i> , <b>DWORD</b> <i>VV</i> , <b>DWORD</b> <i>VA</i> )
<b>✘ eRET</b> ETM_MACRO_LINE_3D_INITIAL ( <b>HANDLE</b> <i>hEtm</i> , <b>BYTE</b> <i>cardNo</i> , <b>BYTE</b> <i>axis1</i> , <b>BYTE</b> <i>axis2</i> , <b>BYTE</b> <i>axis3</i> , <b>DWORD</b> <i>VSV</i> , <b>DWORD</b> <i>VV</i> , <b>DWORD</b> <i>VA</i> )

**Description:**

This function sets the necessary parameters for a 3-axis continuous linear interpolation using symmetric T-curve speed profile.

**Category:**

MODBUS sub\_function; RTC and MP.

**Parameters:**

Parameters	Description
<i>hEtm</i> :	TCP/IP connection handle
<i>cardNo</i> :	1 (ET-M8194H supports only one i-8094H module)
<i>axis1</i> :	The first axis (axis 1). Please refer to Table 3. The axis can be either X, Y, Z or U (1 or 2 or 4 or 8).
<i>axis2</i> :	The second axis (axis 2). Please refer to Table 3. The axis can be either X, Y, Z or U (1 or 2 or 4 or 8).
<i>axis3</i> :	The third axis (axis 3). Please refer to Table 3. The axis can be either X, Y, Z or U (1 or 2 or 4 or 8).
<i>VSV</i> :	Starting speed (in PPS)
<i>VV</i> :	Vector speed (in PPS)
<i>VA</i> :	Vector acceleration (PPS/sec)

**Return:**

0: Success; Others: Fail (Please refer to chapter 2.2)

**Remark:**

The Sub\_function code of ETM\_LINE\_3D\_INITIAL is 0A 7F.  
The Sub\_function code of ETM\_MACRO\_LINE\_3D\_INITIAL is 0C 7F.

**MODBUS example:**

```
ETM_LINE_3D_INITIAL (hEtm, 1, AXIS_X, AXIS_Y, AXIS_Z, 300, 18000,
500000);
//This function should be defined before the ETM_LINE_3D_CONTINUE()
//function is used. Please refer to the example of this function.
```

The MODBUS command is listed as follows:

TID (hex)	PID (hex)	Field Length (hex)	UID (hex)	FC (hex)	St_Addr. (hex)	Word Count (hex)	Byte Count (hex)
00 01	00 00	00 1B	01	10	1F 40	00 0A	14
Register[]	Value (hex)	Remarks					
0	0A 7F/0C 7F	<i>Sub_funciton code</i>					
1	00 01	<i>axis1 (1 → AXIS_X)</i>					
2	00 02	<i>axis2 (2 → AXIS_Y)</i>					
3	00 04	<i>axis3 (4 → AXIS_Z)</i>					
4	00 00	<i>MSW of VSV</i>					
5	01 2C	<i>LSW of VSV (300 = 0x12C)</i>					
6	00 00	<i>MSW of VV</i>					
7	46 50	<i>LSW of VV (18000 = 0x4650)</i>					
8	00 07	<i>MSW of VA</i>					
9	A1 20	<i>LSW of VA (500000 = 0x7A120)</i>					

## 7.4.6 Execute a 3-Axis Continuous Linear Interpolation (Relative Distance)

<b>eRET</b> ETM_LINE_3D_CONTINUE ( <b>HANDLE</b> <i>hEtm</i> , <b>BYTE</b> <i>cardNo</i> , <b>BYTE</b> <i>nType</i> , <b>long</b> <i>fp1</i> , <b>long</b> <i>fp2</i> , <b>long</b> <i>fp3</i> )
<b>✘ eRET</b> ETM_MACRO_LINE_3D_CONTINUE ( <b>HANDLE</b> <i>hEtm</i> , <b>BYTE</b> <i>cardNo</i> , <b>BYTE</b> <i>nType</i> , <b>long</b> <i>fp1</i> , <b>long</b> <i>fp2</i> , <b>long</b> <i>fp3</i> )

**Description:**

This function executes a 3-axis continuous linear interpolation.

**Category:**

MODBUS sub\_function; RTC and MP.

**Parameters:**

Paramters	Description
<i>hEtm:</i>	TCP/IP connection handle
<i>cardNo:</i>	1 (ET-M8194H supports only one i-8094H module)
<i>nType:</i>	0 → 3-axis linear continuous interpolation 1 → end of 3-axis linear continuous interpolation
<i>fp1:</i>	The assigned number of pulses for the axis 1 (in Pulses) (-2,000,000,000 ~ +2,000,000,000)
<i>fp2:</i>	The assigned number of pulses for the axis 2 (in Pulses) (-2,000,000,000 ~ +2,000,000,000)
<i>fp3:</i>	The assigned number of pulses for the axis 3 (in Pulses) (-2,000,000,000 ~ +2,000,000,000)

**Return:**

0: Success; Others: Fail (Please refer to chapter 2.2)

Use the ETM\_GET\_ERROR\_CODE() function to identify the error.

**Remark:**

The Sub\_function code of ETM\_LINE\_3D\_CONTINUE is 0A 81.

The Sub\_function code of ETM\_MACRO\_LINE\_3D\_CONTINUE is 0C 81.

**MODBUS example:**

ETM\_LINE\_3D\_CONTINUE (hEtm, 1, 0, 100, 100, 100);

//execute X, Y, Z 3-axis linear continuous interpolation on module 1

The MODBUS command is listed as follows:

TID (hex)	PID (hex)	Field Length (hex)	UID (hex)	FC (hex)	St_Addr. (hex)	Word Count (hex)	Byte Count (hex)
00 01	00 00	00 17	01	10	1F 40	00 08	10
Register[]		Value (hex)		Remarks			
0		0A 81/0C 81		Sub_funciton code			
1		00 00		nType			
2		00 00		MSW of fp1			
3		00 64		LSW of fp1 (100 = 0x64)			
4		00 00		MSW of fp2			
5		00 64		LSW of fp2			
6		00 00		MSW of fp3			
7		00 64		LSW of fp3			

Related example:

```

BYTE cardNo=1;
unsigned short sv=300; //Set the vector start velocity is 300 PPS ◦
unsigned short v=18000; //Set the vector velocity is 18000 PPS ◦
unsigned long a=500000; //Set the vector acceleration is 500K PPS/s ◦
unsigned short loop1;
ETM_SET_MAX_V(hEtm, cardNo, AXIS_XYZU, 160000L);
// Set the maximum speed of xyzu axes on module 1 to 160K PPS.
ETM_LINE_3D_INITIAL(hEtm, cardNo, AXIS_X, AXIS_Y, AXIS_Z, sv, v, a);
for (loop1 = 0; loop1 < 10000; loop1++)
{
    ETM_LINE_3D_CONTINUE(hEtm, cardNo, 0, 100, 100, 100);
    ETM_LINE_3D_CONTINUE(hEtm, cardNo, 0, -100, -100, -100);
    //execute X, Y, Z 3-axis linear continuous interpolation on module 1
}
ETM_LINE_3D_CONTINUE (hEtm, 1, 0, 100, 100, 100);
//end X, Y, Z 3-axis linear continuous interpolation on module 1

```



## 7.4.7 Execute a 3-Axis Continuous Linear Interpolation (Absolut Position)

```
eRET ETM_ABS_LINE_3D_CONTINUE (HANDLE hEtm, BYTE cardNo,
    BYTE nType, long fp1, long fp2, long fp3)
※ eRET ETM_ABS_MACRO_LINE_3D_CONTINUE (HANDLE hEtm, BYTE
    cardNo, BYTE nType, long fp1, long fp2, long fp3)
```

**Description:**

This function executes a 3-axis continuous linear interpolation to the absolute position specified.

**Category:**

MODBUS sub\_function; RTC and MP.

**Parameters:**

Paramters	Description
<i>hEtm:</i>	TCP/IP connection handle
<i>cardNo:</i>	1 (ET-M8194H supports only one i-8094H module)
<i>nType:</i>	0 → 3-axis linear continuous interpolation 1 → end of 3-axis linear continuous interpolation
<i>fp1:</i>	The absolute position of axis 1 (in Pulses) (-2,000,000,000 ~ +2,000,000,000)
<i>fp2:</i>	The absolute position of axis 2 (in Pulses) (-2,000,000,000 ~ +2,000,000,000)
<i>fp3:</i>	The absolute position of axis 3 (in Pulses) (-2,000,000,000 ~ +2,000,000,000)

**Return:**

0: Success; Others: Fail (Please refer to chapter 2.2)  
Use the ETM\_GET\_ERROR\_CODE() function to identify the error.

**Remark:**

The Sub\_function code of ETM\_ABS\_LINE\_3D\_CONTINUE is 0x0AFC.  
The Sub\_function code of ETM\_ABS\_MACRO\_LINE\_3D\_CONTINUE is 0x0CFC.

**MODBUS example:**

```
ETM_ABS_LINE_3D_CONTINUE (hEtm, 1, 0, 100, 100, 100);
//execute X, Y, Z 3-axis linear continuous interpolation on module 1
```

The MODBUS command is listed as follows:

TID (hex)	PID (hex)	Field Length (hex)	UID (hex)	FC (hex)	St_Addr. (hex)	Word Count (hex)	Byte Count (hex)
00 01	00 00	00 17	01	10	1F 40	00 08	10
Register[]		Value (hex)		Remarks			
0		0A FC/0C FC		<i>Sub_functon code</i>			
1		00 00		<i>nType</i>			
2		00 00		<i>MSW of fp1</i>			
3		00 64		<i>LSW of fp1 (100 = 0x64)</i>			
4		00 00		<i>MSW of fp2</i>			
5		00 64		<i>LSW of fp2</i>			
6		00 00		<i>MSW of fp3</i>			
7		00 64		<i>LSW of fp3</i>			

Related example:

```

BYTE cardNo=1;
unsigned short sv=300; //Set the vector start velocity is 300 PPS ◦
unsigned short v=18000; //Set the vector velocity is 18000 PPS ◦
unsigned long a=500000; //Set the vector acceleration is 500K PPS/s ◦
unsigned short loop1;
ETM_SET_MAX_V(hEtm, cardNo, AXIS_XYZU, 160000L);
// Set the maximum speed of xyzu axes on module 1 to 160K PPS.
ETM_LINE_3D_INITIAL(hEtm, cardNo, AXIS_X, AXIS_Y, AXIS_Z, sv, v, a);
for (loop1 = 0; loop1 < 10000; loop1++)
{
    ETM_ABS_LINE_3D_CONTINUE(hEtm, cardNo, 0, 100, 100, 100);
    ETM_ABS_LINE_3D_CONTINUE(hEtm, cardNo, 0, -100, -100, -100);
    //execute X, Y, Z 3-axis linear continuous interpolation on module 1
}
ETM_LINE_3D_CONTINUE (hEtm, 1, 0, 100, 100, 100);
//end X, Y, Z 3-axis linear continuous interpolation on module 1

```

## 7.4.8 Set the Speed of Mixed 2-axis motions in Continuous Interpolation

eRET	ETM_MIX_2D_INITIAL (HANDLE <i>hEtm</i> , BYTE <i>cardNo</i> , BYTE <i>axis1</i> , BYTE <i>axis2</i> , BYTE <i>nAcc</i> , DWORD <i>VSV</i> , DWORD <i>VV</i> , DWORD <i>VA</i> )
※ eRET	ETM_MACRO_MIX_2D_INITIAL (HANDLE <i>hEtm</i> , BYTE <i>cardNo</i> , BYTE <i>axis1</i> , BYTE <i>axis2</i> , BYTE <i>nAcc</i> , DWORD <i>VSV</i> , DWORD <i>VV</i> , DWORD <i>VA</i> )

### Description:

This function does the initial settings for mixed linear and circular 2-axis motions in continuous interpolation.

### Category:

MODBUS sub\_function; RTC and MP.

### Parameters:

Paramters	Description
<i>hEtm</i> :	TCP/IP connection handle
<i>cardNo</i> :	1 (ET-M8194H supports only one i-8094H module)
<i>axis1</i> :	The first axis (axis 1). Please refer to Table 3. The axis can be either X, Y, Z or U (1 or 2 or 4 or 8).
<i>axis2</i> :	The second axis (axis 2). Please refer to Table 3. The axis can be either X, Y, Z or U (1 or 2 or 4 or 8).
<i>nAcc</i> :	0 → constant speed (VV) 1 → symmetric T-curve Acc/Dec (VSV、VV、VA)
<i>VSV</i> :	Starting speed (in PPS)
<i>VV</i> :	Vector speed (in PPS)
<i>VA</i> :	Vector acceleration (PPS/Sec)

### Return:

0: Success; Others: Fail (Please refer to chapter 2.2)

### Remark:

The Sub\_function code of ETM\_MIX\_2D\_INITIAL is 0A 82.

The Sub\_function code of ETM\_MACRO\_MIX\_2D\_INITIAL is 0C 82.

### MODBUS example:

```
ETM_MIX_2D_INITIAL (hEtm, 1, 1, 2, 0, 300, 18000, 500000);
//This function should be defined before the ETM_MIX_2D_CONTINUE()
//function is used. Please refer to the example of this function.
```

The MODBUS command is listed as follows:

TID (hex)	PID (hex)	Field Length (hex)	UID (hex)	FC (hex)	St_Addr. (hex)	Word Count (hex)	Byte Count (hex)
00 01	00 00	00 1B	01	10	1F 40	00 0A	14
Register[]	Value (hex)	Remarks					
0	0A 82/0C B2	<i>Sub_funciton code</i>					
1	00 01	<i>axis1 (1 → AXIS_X)</i>					
2	00 02	<i>axis2 (2 → AXIS_Y)</i>					
3	00 00	<i>nAcc</i>					
4	00 00	<i>MSW of VSV</i>					
5	01 2C	<i>LSW of VSV (300 = 0x12C)</i>					
6	00 00	<i>MSW of VV</i>					
7	46 50	<i>LSW of VV (18000 = 0x4650)</i>					
8	00 07	<i>MSW of VA</i>					
9	A1 20	<i>LSW of VA (500000 = 0x7A120)</i>					

## 7.4.9 Execute a Mixed 2-axis motions in Continuous Interpolation (Relative Distance)

<b>eRET</b> ETM_MIX_2D_CONTINUE ( <b>HANDLE</b> <i>hEtm</i> , <b>BYTE</b> <i>cardNo</i> , <b>BYTE</b> <i>nAcc</i> , <b>BYTE</b> <i>nType</i> , <b>long</b> <i>cp1</i> , <b>long</b> <i>cp2</i> , <b>long</b> <i>fp1</i> , <b>long</b> <i>fp2</i> )
※ <b>eRET</b> ETM_MACRO_MIX_2D_CONTINUE ( <b>HANDLE</b> <i>hEtm</i> , <b>BYTE</b> <i>cardNo</i> , <b>BYTE</b> <i>nAcc</i> , <b>BYTE</b> <i>nType</i> , <b>long</b> <i>cp1</i> , <b>long</b> <i>cp2</i> , <b>long</b> <i>fp1</i> , <b>long</b> <i>fp2</i> )

### Description:

This function executes mixed linear and circular 2-axis motion in continuous interpolation.

### Category:

MODBUS sub\_function; RTC and MP.

### Parameters:

Parameters	Description
<i>hEtm</i> :	TCP/IP connection handle
<i>cardNo</i> :	1 (ET-M8194H supports only one i-8094H module)
<i>nAcc</i> :	0 → continuous interpolation. 1 → it is the last command of this continuous interpolation. In Acc/Dec mode, it will perform a deceleration stop. In constant speed mode, it will directly stop rather than decelerate.
<i>nType</i> :	1 → ETM_LINE_2D( <b>BYTE</b> <i>cardNo</i> , <b>long</b> <i>fp1</i> , <b>long</b> <i>fp2</i> ) 2 → ETM_ARC_CW( <b>BYTE</b> <i>cardNo</i> , <b>long</b> <i>cp1</i> , <b>long</b> <i>cp2</i> , <b>long</b> <i>fp1</i> , <b>long</b> <i>fp2</i> ) 3 → ETM_ARC_CCW( <b>BYTE</b> <i>cardNo</i> , <b>long</b> <i>cp1</i> , <b>long</b> <i>cp2</i> , <b>long</b> <i>fp1</i> , <b>long</b> <i>fp2</i> ) 4 → ETM_CIRCLE_CW( <b>BYTE</b> <i>cardNo</i> , <b>long</b> <i>cp1</i> , <b>long</b> <i>cp2</i> ) 5 → ETM_CIRCLE_CCW( <b>BYTE</b> <i>cardNo</i> , <b>long</b> <i>cp1</i> , <b>long</b> <i>cp2</i> )
<i>cp1</i> :	It assigns the center point data at axis 1 (-2,000,000,000 ~ +2,000,000,000)
<i>cp2</i> :	It assigns the center point data at axis 2 (-2,000,000,000 ~ +2,000,000,000)
<i>fp1</i> :	It assigned number of pulses for axis 1 (-2,000,000,000 ~ +2,000,000,000)
<i>fp2</i> :	It assigned number of pulses for axis 2 (-2,000,000,000 ~ +2,000,000,000)

**Return:**

0: Success; Others: Fail (Please refer to chapter 2.2)  
Use the ETM\_GET\_ERROR\_CODE() function to identify the error.

**Remark:**

The Sub\_function code of ETM\_MIX\_2D\_CONTINUE is 0A 84.  
The Sub\_function code of ETM\_MACRO\_MIX\_2D\_CONTINUE is 0C 84.

**MODBUS example:**

ETM\_MIX\_2D\_CONTINUE (hEtm, 1, 0, 1, 0, 0, 100, 100);  
*//execute X, Y, 2-axis motions in continuous interpolation on module 1*

The MODBUS command is listed as follows:

TID (hex)	PID (hex)	Field Length (hex)	UID (hex)	FC (hex)	St_Addr. (hex)	Word Count (hex)	Byte Count (hex)
00 01	00 00	00 1D	01	10	1F 40	00 0B	16
Register[]		Value (hex)		Remarks			
0		0A 84/0C 84		Sub_functicon code			
1		00 00		nAcc			
2		00 01		nType			
3		00 00		MSW of cp1			
4		00 00		LSW of cp1 (for linear motion, set 0)			
5		00 00		MSW of cp2			
6		00 00		LSW of cp2 (for linear motion, set 0)			
7		00 00		MSW of fp1			
8		00 64		LSW of fp1 (100 = 0x64)			
9		00 00		MSW of fp2			
10		00 64		LSW of fp2 (100 = 0x64)			

## 7.4.10 Execute a Mixed 2-axis motions in Continuous Interpolation (Absoul Position)

eRET	ETM_ABS_MIX_2D_CONTINUE (HANDLE <i>hEtm</i> , BYTE <i>cardNo</i> , BYTE <i>nAcc</i> , BYTE <i>nType</i> , long <i>cp1</i> , long <i>cp2</i> , long <i>fp1</i> , long <i>fp2</i> )
※ eRET	ETM_ABS_MACRO_MIX_2D_CONTINUE (HANDLE <i>hEtm</i> , BYTE <i>cardNo</i> , BYTE <i>nAcc</i> , BYTE <i>nType</i> , long <i>cp1</i> , long <i>cp2</i> , long <i>fp1</i> , long <i>fp2</i> )

### Description:

This function executes mixed linear and circular 2-axis absolute position continuous interpolation motion.

### Category:

MODBUS sub\_function; RTC and MP.

### Parameters:

Paramters	Description
<i>hEtm</i> :	TCP/IP connection handle
<i>cardNo</i> :	1 (ET-M8194H supports only one i-8094H module)
<i>nAcc</i> :	0 → continuous interpolation. 1 → it is the last command of this continuous interpolation. In Acc/Dec mode, it will perform a deceleration stop. In constant speed mode, it will directly stop rather than decelerate.
<i>nType</i> :	1 → ETM_ABS_LINE_2D(BYTE <i>cardNo</i> , long <i>fp1</i> , long <i>fp2</i> ) 2 → ETM_ABS_ARC_CW(BYTE <i>cardNo</i> , long <i>cp1</i> , long <i>cp2</i> , long <i>fp1</i> , long <i>fp2</i> ) 3 → ETM_ABS_ARC_CCW(BYTE <i>cardNo</i> , long <i>cp1</i> , long <i>cp2</i> , long <i>fp1</i> , long <i>fp2</i> ) 4 → ETM_ABS_CIRCLE_CW(BYTE <i>cardNo</i> , long <i>cp1</i> , long <i>cp2</i> ) 5 → ETM_ABS_CIRCLE_CCW(BYTE <i>cardNo</i> , long <i>cp1</i> , long <i>cp2</i> )
<i>cp1</i> :	the absolute center position of axis 1 (-2,000,000,000 ~ +2,000,000,000)
<i>cp2</i> :	the absolute center position of axis 2 (-2,000,000,000 ~ +2,000,000,000)
<i>fp1</i> :	The absolute end position of axis 1 (-2,000,000,000 ~ +2,000,000,000)
<i>fp2</i> :	The absolute end position of axis 2 (-2,000,000,000 ~ +2,000,000,000)

**Return:**

0: Success; Others: Fail (Please refer to chapter 2.2)  
Use the ETM\_GET\_ERROR\_CODE() function to identify the error.

**Remark:**

The Sub\_function code of ETM\_ABS\_MIX\_2D\_CONTINUE is 0x0AFD.  
The Sub\_function code of ETM\_ABS\_MACRO\_MIX\_2D\_CONTINUE is 0x0CFD.

**MODBUS example:**

ETM\_ABS\_MIX\_2D\_CONTINUE (hEtm, 1, 0, 1, 0, 0, 100, 100);  
*//execute X, Y, 2-axis motions in continuous interpolation on module 1*

The MODBUS command is listed as follows:

TID (hex)	PID (hex)	Field Length (hex)	UID (hex)	FC (hex)	St_Addr. (hex)	Word Count (hex)	Byte Count (hex)
00 01	00 00	00 1D	01	10	1F 40	00 0B	16
Register[]		Value (hex)		Remarks			
0		0A FD/0C FD		<i>Sub_funciton code</i>			
1		00 00		<i>nAcc</i>			
2		00 01		<i>nType</i>			
3		00 00		<i>MSW of cp1</i>			
4		00 00		<i>LSW of cp1 (for linear motion, set 0)</i>			
5		00 00		<i>MSW of cp2</i>			
6		00 00		<i>LSW of cp2 (for linear motion, set 0)</i>			
7		00 00		<i>MSW of fp1</i>			
8		00 64		<i>LSW of fp1 (100 = 0x64)</i>			
9		00 00		<i>MSW of fp2</i>			
10		00 64		<i>LSW of fp2 (100 = 0x64)</i>			



## 7.4.11 3-Axis Helical Motion

<b>eRET</b>	<b>ETM_HELIX_3D</b> ( <b>HANDLE</b> <i>hEtm</i> , <b>BYTE</b> <i>cardNo</i> , <b>BYTE</b> <i>axis1</i> , <b>BYTE</b> <i>axis2</i> , <b>BYTE</b> <i>axis3</i> , <b>BYTE</b> <i>nDir</i> , <b>DWORD</b> <i>VV</i> , <b>long</b> <i>cp1</i> , <b>long</b> <i>cp2</i> , <b>long</b> <i>cycle</i> , <b>long</b> <i>pitch</i> )
<b>※ eRET</b>	<b>ETM_MACRO_HELIX_3D</b> ( <b>HANDLE</b> <i>hEtm</i> , <b>BYTE</b> <i>cardNo</i> , <b>BYTE</b> <i>axis1</i> , <b>BYTE</b> <i>axis2</i> , <b>BYTE</b> <i>axis3</i> , <b>BYTE</b> <i>nDir</i> , <b>DWORD</b> <i>VV</i> , <b>long</b> <i>cp1</i> , <b>long</b> <i>cp2</i> , <b>long</b> <i>cycle</i> , <b>long</b> <i>pitch</i> )

### Description:

This function performs a 3-axis helical motion. However, it is a software macro-function; therefore, it requires CPU resources to run this function.

### Category:

MODBUS sub\_function; RTC and MP.

### Parameters:

Paramters	Description
<i>hEtm</i> :	TCP/IP connection handle
<i>cardNo</i> :	1 (ET-M8194H supports only one i-8094H module)
<i>axis1</i> :	The first axis (axis 1). Please refer to Table 3. The axis can be either X, Y, Z or U (1 or 2 or 4 or 8).
<i>axis2</i> :	The second axis (axis 2). Please refer to Table 3. The axis can be either X, Y, Z or U (1 or 2 or 4 or 8).
<i>axis3</i> :	The third axis (axis 3). Please refer to Table 3. The axis can be either X, Y, Z or U (1 or 2 or 4 or 8).
<i>nDir</i> :	0 → Move in a CW direction. 1 → Move in a CCW direction.
<i>VV</i> :	Vector speed (in PPS)
<i>cp1</i> :	The value of center at axis 1 (-2,000,000,000 ~ +2,000,000,000)
<i>cp2</i> :	The value of center at axis 2 (-2,000,000,000 ~ +2,000,000,000)
<i>cycle</i> :	Number of cycle (-2,000,000,000 ~ +2,000,000,000)
<i>pitch</i> :	Pitch per revolution (the advanced distance for each revolution) (-2,000,000,000 ~ +2,000,000,000)

### Return:

0: Success; Others: Fail (Please refer to chapter 2.2)  
Use the ETM\_GET\_ERROR\_CODE() function to identify the error.

### Remark:

The Sub\_function code of ETM\_HELIX\_3D is 0A 88.  
The Sub\_function code of ETM\_MACRO\_HELIX\_3D is 0C 88.

**MODBUS example:**

```
ETM_HELIX_3D (hEtm, 1, AXIS_Y, AXIS_Z, AXIS_U, 1, 50000, 0, 25000, 50, 3600);
```

//the circular motion is on YZ plane, and the linear motion is along the U axis.

The MODBUS command is listed as follows:

TID (hex)	PID (hex)	Field Length (hex)	UID (hex)	FC (hex)	St_Addr. (hex)	Word Count (hex)	Byte Count (hex)
00 01	00 00	00 25	01	10	1F 40	00 0F	1E
Register[]		Value (hex)		Remarks			
0		0A 88/0C 88		Sub_functon code			
1		00 02		axis1 (2 → AXIS_Y)			
2		00 04		axis2 (4 → AXIS_Z)			
3		00 08		axis3 (8 → AXIS_U)			
4		00 01		nDir			
5		00 00		MSW of VV			
6		C3 50		LSW of VV (50000 = 0xC350)			
7		00 00		MSW of cp1			
8		00 00		LSW of cp1 (0 = 0x0)			
9		00 00		MSW of cp2			
10		61 A8		LSW of cp2 (25000 = 0x61A8)			
11		00 00		MSW of cycle			
12		00 32		LSW of cycle (50 → 0x32)			
13		00 00		MSW of pitch			
14		0E 10		LSW of pitch (3600 → 0xE10)			

**Related example :**

```
BYTE cardNo=1; //select module 1.
//=====
ETM_SET_MAX_V(hEtm, cardNo, AXIS_XYZU,160000L);
//set maximum speed for all axes to 160K PPS.
long v=50000; //set vector speed to 50K PPS.
ETM_HELIX_3D(hEtm, cardNo, AXIS_Y, AXIS_Z, AXIS_X, 1, v, 0, 1000, 5, -
2000);
//the circular motion is on YZ plane, and the linear motion is
//along the X axis.
//=====
ETM_SET_MAX_V(hEtm, cardNo, AXIS_XYZU,160000L);
//set the maximum speed for all axes to 160K PPS.
long v=100000; //set vector speed to 100K PPS.
ETM_HELIX_3D(hEtm, cardNo, AXIS_Y, AXIS_Z, AXIS_U, 1, v, 0, 25000, 50,
3600);
//the circular motion is on YZ plane, and the linear motion is along
//the U axis.
```

## 7.4.12 Set Synchronous Line Scan Motion

**eRET ETM\_LINE\_SCAN (HANDLE *hEtm*, BYTE *cardNo*, BYTE *axis*, BYTE *Type*, BYTE *outEdge*, BYTE *PulseWidth*, long *Pitch*)**

### Description:

Equal distance Line Scan trigger out: Max speed < 100KHz (Pulse Width 10uS). Unequal distance Line Scan trigger out : Max speed < 18KHz.

### Category:

MODBUS sub\_function; RTC.

### Parameters:

Paramters	Description
<i>hEtm</i> :	TCP/IP connection handle
<i>cardNo</i> :	1 (ET-M8194H supports only one i-8094H module)
<i>axis</i> :	Axis number: equal distance X or Y (1, 2) unequal distance X (1).
<i>Type</i> :	0 = equal distance motion (please refer to C+ · LP) 1 = unequal distance motion (please refer to C+ · LP) 2 = equal distance motion (please refer to C+ · EP) 3 = unequal distance motion (please refer to C+ · EP)
<i>outEdge</i> :	Output active logic: 0 = low active (0V); 1 = high active (5V)
<i>PulseWidth</i> :	Output pulse width 0 = 10 uSec 1 = 20 uSec 2 = 100 uSec 3 = 200 uSec 4 = 1,000 uSec 5 = 2,000 uSec 6 = 10,000 uSec 7 = 20,000 uSec
<i>pitch</i> :	Specify interval pulses (-2,000,000,000 ~ +2,000,000,000)

### Return:

0: Success; Others: Fail (Please refer to chapter 2.2)

### MODBUS example:

```
ETM_LINE_SCAN (hEtm, 1, AXIS_X, 0, 0, 0, -39);
//Sets the equal distance Line Scan trigger on axis-X.
//One trigger will be sent out every 40 (=39+1) pulses.
```

The MODBUS command is listed as follows:

TID (hex)	PID (hex)	Field Length (hex)	UID (hex)	FC (hex)	St_Addr. (hex)	Word Count (hex)	Byte Count (hex)
00 01	00 00	00 15	01	10	1F 40	00 07	0E
Register[]		Value (hex)		Remarks			
0		0A 90		Sub_functon code			
1		00 01		axis (1 → AXIS_X)			
2		00 00		Type (even distance trigger)			
3		00 00		outEdge (high level pulse)			
4		00 00		PulseWidth (0 → 10 uSec)			
5		FF FF		MSW of Pitch			
6		FF D9		LSW of Pitch (-39 = 0xFFFFFD9)			

Related example:

```

ETM_SET_MAX_V(hEtm, CardNo, AXIS_XY, 4000000);
//set the maximum speed of X and Y axes to 4M PPS.
ETM_NORMAL_SPEED(hEtm, CardNo, AXIS_XY, 0);
//set the driving mode to be symmetric T-curve.
ETM_SET_V(hEtm, CardNo, AXIS_XY, 2000000);
//set the speed of X and Y axes to 2M PPS.
ETM_SET_A(hEtm, CardNo, AXIS_XY, 20000000);
//set the acceleration of X and Y axes to 2M PPS/S.
ETM_SET_SV(hEtm, CardNo, AXIS_XY, 2000000);
//set the starting speed of X and Y axes to 2M PPS.
ETM_LINE_SCAN(hEtm, CardNo, AXIS_X, 0, 0, 0, -39);
//Sets the equal distance Line Scan trigger on axis-X.
//One trigger will be sent out every 40 (=39+1) pulses.
ETM_LINE_SCAN(hEtm, CardNo, AXIS_Y, 0, 0, 0, -79);
//Sets the equal distance Line Scan trigger on axis-Y.
//One trigger will be sent out every 80 (=79+1) pulses.
ETM_LINE_SCAN_START(hEtm, CardNo, AXIS_XY, 0, -4000000);
//Towards the negative direction move 400K PPS.

```

## 7.4.13 Start Synchronous Line Scan Motion

**eRET ETM\_LINE\_SCAN\_START (HANDLE *hEtm*, BYTE *cardNo*, BYTE *axis*, BYTE *Type*, long *Position*)**

### Description:

Enable Line Scan trigger out motion.

When performing unequal distance motion, please note (there is no restriction for equal distance motion):

- a. All ISR will be stopped.
- b. Do not execute the following commands:

ETM\_READ\_bVAR  
 ETM\_READ\_VAR  
 ETM\_GET\_LP  
 ETM\_GET\_EP  
 ETM\_GET\_CV  
 ETM\_GET\_CA  
 ETM\_GET\_DI  
 ETM\_GET\_ERROR  
 ETM\_GET\_ERROR\_CODE  
 ETM\_GET\_LATCH  
 ETM\_STOP\_WAIT  
 ETM\_CLEAR\_STOP

### Category:

MODBUS sub\_function; RTC.

### Parameters:

Paramters	Description
<i>hEtm</i> :	TCP/IP connection handle
<i>cardNo</i> :	1 (ET-M8194H supports only one i-8094H module)
<i>axis</i> :	Axis number: Fixed offset displacement X (1) or Y (2) or XY (3); or unequal offset distance X (1).
<i>Type</i> :	0 = equal distance motion (according to LP value) *1 = unequal distance motion (according to LP value) 2 = equal distance motion (according to EP value) *3 = unequal distance motion (according to EP value)  * reserve
<i>Position</i> :	Total pulses, moving distance (-2,000,000,000 ~ +2,000,000,000)

### Return:

0: Success; Others: Fail (Please refer to chapter 2.2)

**MODBUS example:**

**ETM\_LINE\_SCAN\_START (hEtm, 1, AXIS\_XY, 0, -4000000);**

**//Towards the negative direction move 4000K PPS.**

The MODBUS command is listed as follows:

TID (hex)	PID (hex)	Field Length (hex)	UID (hex)	FC (hex)	St_Addr. (hex)	Word Count (hex)	Byte Count (hex)
00 01	00 00	00 11	01	10	1F 40	00 05	0A
Register[]		Value (hex)		Remarks			
0		0A 91		<i>Sub_funciton code</i>			
1		00 03		<i>axis (3 → AXIS_XY)</i>			
2		00 00		<i>Type</i>			
3		FF C2		<i>MSW of Position</i>			
4		F7 00		<i>LSW of Position (-4000000 = 0xFFC2F700)</i>			

## 7.4.14 Get Synchronous Line Scan Motion Status

**eRET ETM\_GET\_LINE\_SCAN\_DONE (HANDLE *hEtm*, BYTE *cardNo*, BYTE\* *LScanState*)**

### Description:

After calling ETM\_LINE\_SCAN\_START, the ETM\_GET\_LINE\_SCAN\_DONE function will determine if the line scan procedure has finished. The line scan done flag will be reset after calling ETM\_LINE\_SCAN\_START.

### Category:

MODBUS table ; RTC.

### Parameters:

Paramters	Description
<i>hEtm</i> :	TCP/IP connection handle
<i>cardNo</i> :	1 (ET-M8194H supports only one i-8094H module)
<i>LScanState</i> :	1: line scan process has been completed 0: no interrupt occurred

### Return:

0: Success; Others: Fail (Please refer to chapter 2.2)

### MODBUS example:

BYTE *bState*;  
ETM\_GET\_LINE\_SCAN\_DONE (*hEtm*, 1, & *bState*);

### MODBUS request:

TID (hex)	PID (hex)	Field Length (hex)	UID (hex)	FC (hex)	St_Addr. (hex)	Word Count (hex)
00 01	00 00	00 06	01 (Card No.)	04	00 49 (73)	00 01

### MODBUS response:

TID (hex)	PID (hex)	Field Length (hex)	UID (hex)	FC (hex)	Byte Count (hex)	Register (hex)
00 01	00 00	00 05	01	04	02	00 01 line scan operation has ended

## 7.5 Stop and Hold Functions

### 7.5.1 Driving Command Hold

**eRET ETM\_DRV\_HOLD (HANDLE *hEtm*, BYTE *cardNo*, BYTE *axis*)**

**※Δ eRET ETM\_MACRO\_DRV\_HOLD (HANDLE *hEtm*, BYTE *cardNo*, BYTE *axis*)**

#### Description:

This command prevents the next motion command from executing but it does not stop the current running command. The held frozen motion command(s) can be activated again by calling ETM\_DRV\_START(). The purpose of this command is to support the simultaneous start of multi-axis driving. The user may write other commands after the ETM\_DRV\_HOLD command is issued. The ETM\_DRV\_START releases the hold command and start executing the motion commands issued after the hold command.

#### Category:

MODBUS sub\_function; RTC, MP and ISR.

#### Parameters:

Parameters	Description
<i>hEtm</i> :	TCP/IP connection handle
<i>cardNo</i> :	1 (ET-M8194H supports only one i-8094H module)
<i>axis</i> :	Axis or axes (Please refer to Table 3) The axis can be either X, Y, Z or U (1 or 2 or 4 or 8)

#### Return:

0: Success; Others: Fail (Please refer to chapter 2.2)

#### Remark:

The Sub\_function code of ETM\_DRV\_HOLD is 0A B4.  
The Sub\_function code of ETM\_MACRO\_DRV\_HOLD is 0C B4.

#### MODBUS example:

ETM\_DRV\_HOLD (*hEtm*, 1, AXIS\_XYU);  
//hold the driving command to XYU



The MODBUS command is listed as follows:

TID (hex)	PID (hex)	Field Length (hex)	UID (hex)	FC (hex)	St_Addr. (hex)	Word Count (hex)	Byte Count (hex)
00 01	00 00	00 0B	01	10	1F 40	00 02	04
Register[]		Value (hex)		Remarks			
0		0A B4/0C B4		Sub_funciton code			
1		00 0B		axis (B → AXIS_XYU)			

Related example:

```

BYTE cardNo=1; //select card 1.
ETM_DRV_HOLD(hEtm, cardNo, AXIS_XYU);
//hold the driving command to XYU
ETM_SET_MAX_V(hEtm, cardNo, AXIS_U, 10000);
//set the maximum speed of U-axis to be 10K PPS.
ETM_NORMAL_SPEED(hEtm, cardNo, AXIS_U, 0);
//set the driving mode to be symmetric T-curve.
ETM_SET_V(hEtm, cardNo, AXIS_U, 2000);
//set the speed of U-axis to 2,000 PPS.
ETM_SET_A(hEtm, cardNo, AXIS_U,1000);
//set the acceleration of U-axis to 1,000 PPS/S.
ETM_SET_SV(hEtm, cardNo, AXIS_U, 2000);
//set the starting speed to 2,000 PPS.
ETM_SET_AO(hEtm, cardNo, AXIS_U, 9); // set the AO to 9 Pulses.
ETM_SET_MAX_V(hEtm, cardNo, AXIS_XY, 20000);
//set the maximum speed of X and Y axes to 20K PPS.
ETM_AXIS_ASSIGN(hEtm, cardNo, AXIS_X, AXIS_Y, 0);
//set the X-axis as the axis 1 and Y-axis as the axis 2 for a 2-axis
// interpolation.
ETM_VECTOR_SPEED(hEtm, cardNo, 0);
//set constant speed motion. Therefore, VSV=VV. Only VV is required.
ETM_SET_VV(hEtm, cardNo, 5000);
//set the vector speed for card 1 to 5,000 PPS.
ETM_FIXED_MOVE(hEtm, cardNo, AXIS_U, 5000);
//command U-axis to move 5,000 Pulse. This command is be held.
ETM_LINE_2D(hEtm, cardNo, 12000, 10000);
//command a linear interpolation motion on the XY planes. It is held, too.
ETM_DRV_START(hEtm, cardNo, AXIS_XYU);
//release the holding status. X,Y , and U axes will start to move
// simultaneously.

```

## 7.5.2 Release Holding Status and Start Driving

**eRET ETM\_DRV\_START (HANDLE *hEtm*, BYTE *cardNo*, BYTE *axis*)**

**※Δ eRET ETM\_MACRO\_DRV\_START (HANDLE *hEtm*, BYTE *cardNo*, BYTE *axis*)**

### Description:

This command releases the holding status, and start the driving of the assigned axes immediately.

### Category:

MODBUS sub\_function; RTC, MP and ISR.

### Parameters:

Paramters	Description
<i>hEtm</i> :	TCP/IP connection handle
<i>cardNo</i> :	1 (ET-M8194H supports only one i-8094H module)
<i>axis</i> :	Axis or axes (Please refer to Table 3) The axis can be either X, Y, Z or U (1 or 2 or 4 or 8)

### Return:

0: Success; Others: Fail (Please refer to chapter 2.2)

### Remark:

The Sub\_function code of ETM\_DRV\_START is 0A B5.

The Sub\_function code of ETM\_MACRO\_DRV\_START is 0C B5.

### MODBUS example:

ETM\_DRV\_START (*hEtm*, 1, AXIS\_XYU);

//release the holding status. X,Y , and U axes will start to move  
// simultaneously.

### The MODBUS command is listed as follows:

TID (hex)	PID (hex)	Field Length (hex)	UID (hex)	FC (hex)	St_Addr. (hex)	Word Count (hex)	Byte Count (hex)
00 01	00 00	00 0B	01	10	1F 40	00 02	04
Register[]	Value (hex)	Remarks					
0	0A B5/0C B5	Sub_function code					
1	00 0B	axis (B → AXIS_XYU)					

Related example:

```
BYTE cardNo=1; //select card 1.
ETM_DRV_HOLD(hEtm, cardNo, AXIS_XYU);
//hold the driving command to XYU
ETM_SET_MAX_V(hEtm, cardNo, AXIS_U, 10000);
//set the maximum speed of U-axis to be 10K PPS.
ETM_NORMAL_SPEED(hEtm, cardNo, AXIS_U, 0);
//set the driving mode to be symmetric T-curve.
ETM_SET_V(hEtm, cardNo, AXIS_U, 2000);
//set the speed of U-axis to 2,000 PPS.
ETM_SET_A(hEtm, cardNo, AXIS_U,1000);
//set the acceleration of U-axis to 1,000 PPS/S.
ETM_SET_SV(hEtm, cardNo, AXIS_U, 2000);
//set the starting speed to 2,000 PPS.
ETM_SET_AO(hEtm, cardNo, AXIS_U, 9); // set the AO to 9 Pulses.
ETM_SET_MAX_V(hEtm, cardNo, AXIS_XY, 20000);
//set the maximum speed of X and Y axes to 20K PPS.
ETM_AXIS_ASSIGN(hEtm, cardNo, AXIS_X, AXIS_Y, 0);
//set the X-axis as the axis 1 and Y-axis as the axis 2 for a 2-axis
// interpolation.
ETM_VECTOR_SPEED(hEtm, cardNo, 0);
//set constant speed motion. Therefore, VSV=VV. Only VV is required.
ETM_SET_VV(hEtm, cardNo, 5000);
//set the vector speed for card 1 to 5,000 PPS.
ETM_FIXED_MOVE(hEtm, cardNo, AXIS_U, 5000);
//command U-axis to move 5,000 Pulse. This command is be held.
ETM_LINE_2D(hEtm, cardNo, 12000, 10000);
//command a linear interpolation motion on the XY planes. It is held, too.
ETM_DRV_START(hEtm, cardNo, AXIS_XYU);
//release the holding status. X,Y , and U axes will start to move
// simultaneously.
```

### 7.5.3 Decelerate and Finally Stop Axes

<b>eRET ETM_STOP_SLOWLY (HANDLE <i>hEtm</i>, BYTE <i>cardNo</i>, BYTE <i>axis</i>)</b>
<b>※ eRET ETM_MACRO_STOP_SLOWLY (HANDLE <i>hEtm</i>, BYTE <i>cardNo</i>, BYTE <i>axis</i>)</b>

**Description:**

This function commands to decelerate and finally stops the assigned axes slowly.

**Category:**

MODBUS sub\_function; RTC, and MP

**Parameters:**

Paramters	Description
<i>hEtm</i> :	TCP/IP connection handle
<i>cardNo</i> :	1 (ET-M8194H supports only one i-8094H module)
<i>axis</i> :	Axis or axes (Please refer to Table 3) The axis can be either X, Y, Z or U (1 or 2 or 4 or 8)

**Return:**

0: Success; Others: Fail (Please refer to chapter 2.2)

**Remark:**

The Sub\_function code of ETM\_STOP\_SLOWLY is 0A B7.

The Sub\_function code of ETM\_MACRO\_STOP\_SLOWLY is 0C B7.

**MODBUS example:**

ETM\_STOP\_SLOWLY (*hEtm*, 1, AXIS\_XY);

//decelerate and stop the X and Y axes

**The MODBUS command is listed as follows:**

TID (hex)	PID (hex)	Field Length (hex)	UID (hex)	FC (hex)	St_Addr. (hex)	Word Count (hex)	Byte Count (hex)
00 01	00 00	00 0B	01	10	1F 40	00 02	04
Register[]		Value (hex)		Remarks			
0		0A B7/0C B7		Sub_functicon code			
1		00 03		axis (3 → AXIS_XY)			

## 7.5.4 Immediately Stop Axes

<b>eRET</b> ETM_STOP_SUDDENLY ( <b>HANDLE</b> <i>hEtm</i> , <b>BYTE</b> <i>cardNo</i> , <b>BYTE</b> <i>axis</i> )
✘ <b>eRET</b> ETM_MACRO_STOP_SUDDENLY ( <b>HANDLE</b> <i>hEtm</i> , <b>BYTE</b> <i>cardNo</i> , <b>BYTE</b> <i>axis</i> )

### Description:

This function commands to immediately stop the assigned axes.

### Category:

MODBUS sub\_function; RTC, and MP

### Parameters:

Paramters	Description
<i>hEtm</i> :	TCP/IP connection handle
<i>cardNo</i> :	1 (ET-M8194H supports only one i-8094H module)
<i>axis</i> :	Axis or axes (Please refer to Table 3) The axis can be either X, Y, Z or U (1 or 2 or 4 or 8)

### Return:

0: Success; Others: Fail (Please refer to chapter 2.2)

### Remark:

The Sub\_function code of ETM\_STOP\_SUDDENLY is 0A B8.

The Sub\_function code of ETM\_MACRO\_STOP\_SUDDENLY is 0C B8.

### MODBUS example:

ETM\_STOP\_SUDDENLY (hEtm, 1, AXIS\_ZU);  
//immediately stop the Z and U axes.

The MODBUS command is listed as follows:

TID (hex)	PID (hex)	Field Length (hex)	UID (hex)	FC (hex)	St_Addr. (hex)	Word Count (hex)	Byte Count (hex)
00 01	00 00	00 0B	01	10	1F 40	00 02	04
Register[]		Value (hex)		Remarks			
0		0A B8/0C B8		Sub_functicon code			
1		00 0C		axis (C → AXIS_ZU)			

## 7.5.5 Decelerate and Finally Stop Interpolation Motion

<b>eRET</b> ETM_VSTOP_SLOWLY ( <b>HANDLE</b> <i>hEtm</i> , <b>BYTE</b> <i>cardNo</i> )
✘ <b>eRET</b> ETM_MACRO_VSTOP_SLOWLY ( <b>HANDLE</b> <i>hEtm</i> , <b>BYTE</b> <i>cardNo</i> )

### Description:

This function commands to stop interpolation motion of the assigned module in a decelerating way.

### Category:

MODBUS sub\_function; RTC, and MP

### Parameters:

Paramters	Description
<i>hEtm</i> :	TCP/IP connection handle
<i>cardNo</i> :	1 (ET-M8194H supports only one i-8094H module)

### Return:

0: Success; Others: Fail (Please refer to chapter 2.2)

### Remark:

The Sub\_function code of ETM\_VSTOP\_SLOWLY is 0A B9.

The Sub\_function code of ETM\_MACRO\_VSTOP\_SLOWLY is 0C B9.

### MODBUS example:

ETM\_VSTOP\_SLOWLY (*hEtm*, 1);

//stop the interpolation of card 1 in a decelerating way.

The MODBUS command is listed as follows:

TID (hex)	PID (hex)	Field Length (hex)	UID (hex)	FC (hex)	St_Addr. (hex)	Word Count (hex)	Byte Count (hex)
00 01	00 00	00 09	01	10	1F 40	00 01	02
Register[]		Value (hex)		Remarks			
0		0A B9/0C B9		Sub_functon code			

## 7.5.6 Immediately Stop Interpolation Motion

<b>eRET</b> ETM_VSTOP_SUDDENLY ( <b>HANDLE</b> <i>hEtm</i> , <b>BYTE</b> <i>cardNo</i> )
<b>✘ eRET</b> ETM_MACRO_VSTOP_SUDDENLY ( <b>HANDLE</b> <i>hEtm</i> , <b>BYTE</b> <i>cardNo</i> )

### Description:

This function commands to stop interpolation motion of the assigned module immediately.

### Category:

MODBUS sub\_function; RTC, and MP

### Parameters:

Paramters	Description
<i>hEtm</i> :	TCP/IP connection handle
<i>cardNo</i> :	1 (ET-M8194H supports only one i-8094H module)

### Return:

0: Success; Others: Fail (Please refer to chapter 2.2)

### Remark:

The Sub\_function code of ETM\_VSTOP\_SUDDENLY is 0A BA.  
The Sub\_function code of ETM\_MACRO\_VSTOP\_SUDDENLY is 0C BA.

### MODBUS example:

```
ETM_VSTOP_SUDDENLY (hEtm, 1);
// stop the interpolation of card 1 immediately.
```

The MODBUS command is listed as follows:

TID (hex)	PID (hex)	Field Length (hex)	UID (hex)	FC (hex)	St_Addr. (hex)	Word Count (hex)	Byte Count (hex)
00 01	00 00	00 09	01	10	1F 40	00 01	02
Register[]		Value (hex)		Remarks			
0		0A BA/0C BA		Sub_functiton code			

## 7.5.7 Clear Axes Stop Status

<b>eRET ETM_CLEAR_STOP (HANDLE <i>hEtm</i>, BYTE <i>cardNo</i>, BYTE <i>axis</i>)</b>
<b>※ eRET ETM_MACRO_CLEAR_STOP (HANDLE <i>hEtm</i>, BYTE <i>cardNo</i>, BYTE <i>axis</i>)</b>

### Description:

After using the stop functions “ETM\_STOP\_SLOWLY” or “ETM\_STOP\_SUDDENLY”, please solve the malfunction, and then issue this function to clear the stop status.

### Category:

MODBUS sub\_function; RTC, and MP

### Parameters:

Paramters	Description
<i>hEtm</i> :	TCP/IP connection handle
<i>cardNo</i> :	1 (ET-M8194H supports only one i-8094H module)
<i>axis</i> :	Axis or axes (Please refer to Table 3) The axis can be either X, Y, Z or U (1 or 2 or 4 or 8)

### Return:

0: Success; Others: Fail (Please refer to chapter 2.2)

### Remark:

The Sub\_function code of ETM\_CLEAR\_STOP is 0A BB.

The Sub\_function code of ETM\_MACRO\_CLEAR\_STOP is 0C BB.

### MODBUS example:

ETM\_CLEAR\_STOP (*hEtm*, 1, AXIS\_ZU);

//clear the error status of zu axes.

The MODBUS command is listed as follows:

TID (hex)	PID (hex)	Field Length (hex)	UID (hex)	FC (hex)	St_Addr. (hex)	Word Count (hex)	Byte Count (hex)
00 01	00 00	00 0B	01	10	1F 40	00 02	04
Register[]	Value (hex)	Remarks					
0	0A BB/0C BB	Sub_function code					
1	00 0C	axis (C → AXIS_ZU)					



## 7.5.8 Clear Interpolation Motion Stop Status

<b>eRET</b> ETM_CLEAR_VSTOP ( <b>HANDLE</b> <i>hEtm</i> , <b>BYTE</b> <i>cardNo</i> )
<b>※ eRET</b> ETM_MACRO_CLEAR_VSTOP ( <b>HANDLE</b> <i>hEtm</i> , <b>BYTE</b> <i>cardNo</i> )

### Description:

After using the stop functions “ETM\_VSTOP\_SLOWLY” or “ETM\_VSTOP\_SUDDENLY”, please solve the malfunction, and then issue this function to clear the stop status.

### Category:

MODBUS sub\_function; RTC, and MP

### Parameters:

Paramters	Description
<i>hEtm</i> :	TCP/IP connection handle
<i>cardNo</i> :	1 (ET-M8194H supports only one i-8094H module)

### Return:

0: Success; Others: Fail (Please refer to chapter 2.2)

### Remark:

The Sub\_function code of ETM\_CLEAR\_VSTOP is 0A 09.

The Sub\_function code of ETM\_MACRO\_CLEAR\_VSTOP is 0C 09.

### MODBUS example:

```
ETM_CLEAR_VSTOP (hEtm, 1);
//clear the error status of card 1.
```

The MODBUS command is listed as follows:

TID (hex)	PID (hex)	Field Length (hex)	UID (hex)	FC (hex)	St_Addr. (hex)	Word Count (hex)	Byte Count (hex)
00 01	00 00	00 09	01	10	1F 40	00 01	02
Register[]		Value (hex)		Remarks			
0		0A 09/0C 09		Sub_funciton code			

## 7.5.9 End of Interpolation

<b>eRET</b> ETM_INTP_END ( <b>HANDLE</b> <i>hEtm</i> , <b>BYTE</b> <i>cardNo</i> , <b>BYTE</b> <i>type</i> )
✘ <b>eRET</b> ETM_MACRO_INTP_END ( <b>HANDLE</b> <i>hEtm</i> , <b>BYTE</b> <i>cardNo</i> , <b>BYTE</b> <i>type</i> )

### Description:

- If the current motion status is running an interpolation motion and you would like to issue a single axis motion or change the coordinate definition, you should call this function before the new command is issued.
- You can redefine the MAX\_V for each axis. In this way, you do not have to execute ETM\_INTP\_END() function.

### Category:

MODBUS sub\_function; RTC, and MP

### Parameters:

Parameters	Description
<i>hEtm</i> :	TCP/IP connection handle
<i>cardNo</i> :	1 (ET-M8194H supports only one i-8094H module)
<i>type</i> :	0 → 2-axis interpolation 1 → 3-axis interpolation

### Return:

0: Success; Others: Fail (Please refer to chapter 2.2)

### Remark:

The Sub\_function code of ETM\_INTP\_END is 0A BC.

The Sub\_function code of ETM\_MACRO\_INTP\_END is 0C BC.

### MODBUS example:

ETM\_INTP\_END (hEtm, 1, 0);

//declare the end of a 2-axis interpolation on card 1.

The MODBUS command is listed as follows:

TID (hex)	PID (hex)	Field Length (hex)	UID (hex)	FC (hex)	St_Addr. (hex)	Word Count (hex)	Byte Count (hex)
00 01	00 00	00 0B	01	10	1F 40	00 02	04
Register[]	Value (hex)	Remarks					
0	0A BC/0C BC	Sub_function code					
1	00 00	type (0 → 2-axis interpolation)					

## 7.5.10 Emergency Stop

**eRET ETM\_EMERGENCY\_STOP (HANDLE *hEtm*, BYTE *cardNo*, BYTE *stopType*)**

### Description:

Stop all the axes and clear all data in i-8094H command buffer.

### Category:

MODBUS sub\_function; RTC.

### Parameters:

Paramters	Description
<i>hEtm</i> :	TCP/IP connection handle
<i>cardNo</i> :	1 (ET-M8194H supports only one i-8094H module)
<i>stopType</i> :	Stop type: 0: immediately stop; 1: deceleration stop

### Return:

0: Success; Others: Fail (Please refer to chapter 2.2)

### MODBUS example:

```
ETM_EMERGENCY_STOP (hEtm, 1, 0);
// Stop all the axes immediately and clear all data in the i-8094H command
//buffer.
```

The MODBUS command is listed as follows:

TID (hex)	PID (hex)	Field Length (hex)	UID (hex)	FC (hex)	St_Addr. (hex)	Word Count (hex)	Byte Count (hex)
00 01	00 00	00 0B	01	10	1F 40	00 02	04
Register[]		Value (hex)		Remarks			
0		0A 04		<i>Sub_function code</i>			
1		00 00		<i>stopType</i>			

## 7.5.11 Clear Emergency Stop

**eRET ETM\_CLEAR\_EMERGENCY\_STOP (HANDLE *hEtm*, BYTE *cardNo*)**

### Description:

After using the stop functions ETM\_EMERGENCY\_STOP, please solve the malfunction, and then issue this function to clear the stop status.

### Category:

MODBUS sub\_function; RTC.

### Parameters:

Paramters	Description
<i>hEtm</i> :	TCP/IP connection handle
<i>cardNo</i> :	1 (ET-M8194H supports only one i-8094H module)

### Return:

0: Success; Others: Fail (Please refer to chapter 2.2)

### MODBUS example:

```
ETM_CLEAR_EMERGENCY_STOP (hEtm, 1);
//clear the error status of card 1.
```

The MODBUS command is listed as follows:

TID (hex)	PID (hex)	Field Length (hex)	UID (hex)	FC (hex)	St_Addr. (hex)	Word Count (hex)	Byte Count (hex)
00 01	00 00	00 09	01	10	1F 40	00 01	02
Register[]		Value (hex)		Remarks			
0		0A 05		Sub_function code			

## 8 Initial Parameter Table

The initial table stores the basic settings of the motion control chip in a non-volatile memory. The initialization table includes the following setting (Figure 3):

- pulse output signal
- encoder setting
- hardware trigger level
- software limits

Function	Parameter	X-Axis	Y-Axis	Z-Axis	U-Axis
Pulse Output Signal	Pulse Output Mode	0	0	0	0
Max Pulse Output Rate	Data (8000 to 4,000,000 PPS)	8000	8000	8000	8000
Hardware Limit Switch (HLMT)	Active Level (forward)	Low Active	Low Active	Low Active	Low Active
	Active Level (reverse)	Low Active	Low Active	Low Active	Low Active
Hardware Limit Stop Mode	Stop Mode	Abrupt Stop	Abrupt Stop	Abrupt Stop	Abrupt Stop
Near Home Sensor	Trigger Level	Low Active	Low Active	Low Active	Low Active
Home Sensor	Trigger Level	Low Active	Low Active	Low Active	Low Active
Software Limit	Enable Software Limit	Disable	Disable	Disable	Disable
	Software Limit (forward)	100000	100000	100000	100000
	Software Limit (reverse)	-100000	-100000	-100000	-100000
	Position Counter Type	Logic Pos	Logic Pos	Logic Pos	Logic Pos
Set Encoder Parameters	Encoder Input Type	A Quad B	A Quad B	A Quad B	A Quad B
	A Quad B Input Signal Division	1/1	1/1	1/1	1/1
	Trigger Level for Z Phase	Low Active	Low Active	Low Active	Low Active
Servo Driver Setting	On/Off	Off	Off	Off	Off
Servo Alarm Setting	Enable Servo Alarm	Disable	Disable	Disable	Disable
	Trigger Level	Low Active	Low Active	Low Active	Low Active
In-Position Signal	Enable In-Position Input	Disable	Disable	Disable	Disable
	Trigger Level	Low Active	Low Active	Low Active	Low Active
Digital Filter	Input Ports	1	1	1	1
	Filter Time Constant	2	2	2	2
Variable Ring Position Counter	Enable Variable Ring Counter	Disable	Disable	Disable	Disable
	Maximum Value	10000	10000	10000	10000
Triangle Driving Profile Prevention	Enable Triangle Prevention	Disable	Disable	Disable	Disable

Figure 3: Initial table

The factory default settings of the initial table are as follows:

```
ETM_SET_PULSE_MODE(hEtm, cardNo, AXIS_XYZU, 0);
ETM_SET_MAX_V(hEtm, cardNo, AXIS_XYZU, 2000000L);
ETM_SET_HLMT(hEtm, cardNo, AXIS_XYZU, 0, 0);
ETM_LIMITSTOP_MODE(hEtm, cardNo, AXIS_XYZU, 0);
ETM_SET_NHOME(hEtm, cardNo, AXIS_XYZU, 0);
```

```
ETM_SET_HOME_EDGE(hEtm, cardNo, AXIS_XYZU, 0);  
ETM_CLEAR_SLMT(hEtm, cardNo, AXIS_XYZU);  
ETM_SET_ENCODER(hEtm, cardNo, AXIS_XYZU, 0, 0, 0);  
ETM_SERVO_OFF(hEtm, cardNo, AXIS_XYZU);  
ETM_SET_ALARM(hEtm, cardNo, AXIS_XYZU, 0, 0);  
ETM_SET_INPOS(hEtm, cardNo, AXIS_XYZU, 0, 0);  
ETM_SET_FILTER(hEtm, cardNo, AXIS_XYZU, 0, 0);  
ETM_VRING_DISABLE(hEtm, cardNo, AXIS_XYZU);  
ETM_AVTRI_DISABLE(hEtm, cardNo, AXIS_XYZU);  
ETM_EXD_DISABLE(hEtm, cardNo, AXIS_XYZU);
```

**Modify the default initial table by calling the above function with the required settings. The settings may also be changed after start up or later on during the control operations. Always the last setting will be retained. Set the initialization table according to the specific environment in which the ET-M8194H is being used by calling the above functions.**

## 8.1 Calling the Initial Table

**eRET ETM\_LOAD\_INITIAL (HANDLE hEtm, BYTE cardNo)**

### Description:

In order to initialize the basic hardware and software settings of the ET-M8194, it is required to call the ETM\_LOAD\_INITIAL function. Directly after power on, the initial table is being automatically called by executing the ETM\_LOAD\_INITIAL function. The Modbus master is also allowed to call this function at any time.

### Category:

MODBUS sub\_function; RTC

### Parameters:

Paramters	Description
<i>hEtm:</i>	TCP/IP connection handle
<i>cardNo:</i>	1 (ET-M8194H supports only one i-8094H module)

### Return:

0: Success; Others: Fail (Please refer to chapter 2.2)

### MODBUS example:

```
ETM_LOAD_INITIAL (hEtm, 1);
// load the initial setting values of the parameter table into i-8094H
```

The MODBUS command is listed as follows:

TID (hex)	PID (hex)	Field Length (hex)	UID (hex)	FC (hex)	St_Addr. (hex)	Word Count (hex)	Byte Count (hex)
00 01	00 00	00 09	01	10	1F 40	00 01	02
Register[]		Value (hex)		Remarks			
0		0A C8		Sub_functon code			

### Related example:

```
ETM_SET_PULSE_MODE(hEtm, 1, INITIAL_XYZU, 0);
//set the pulse mode of X, Y, Z, and U axes as 0, write into the parameter
//table in module 1.
ETM_SET_MAX_V(hEtm, 1, INITIAL_XY, 200000L);
```

```
//The maximum speed for the X and Y axes of module 1 is 200KPPS.  
//Write into the parameter table.  
ETM_SET_HLMT(hEtm, 1, INITIAL_XYZU, 0, 0);  
//set all the trigger levels as low-active for all limit switches  
//on module 1. Write into the parameter table.  
ETM_LIMITSTOP_MODE(hEtm, 1, INITIAL_X, 0);  
//set X axis to stop immediately if any limit switch on X axis is triggered  
//on module 1. Write into the parameter table.  
ETM_SET_NHOME(hEtm, 1, INITIAL_XY, 0);  
//set the trigger level of NHOME of X and Y axes on module 1 to be  
//active low. Write into the parameter table.  
ETM_LOAD_INITIAL(hEtm, 1);  
// load the initial setting values of the parameter table into i-8094H
```



# 9 Macro Programming

## Introduction

Macro programs are written to the nonvolatile memory of the i-8094H module. The nonvolatile memory can hold Macro program of different sizes. Two types of Macro tables are provided:

- MP tables: These tables hold normal motion control Macro commands. MP commands in these tables are being called by the command `ETM_MP_CALL` or `ETM_MACRO_MP_CALL`. The `ETM_MP_CALL` command can be directly called by the host controller, and the `ETM_MACRO_MP_CALL` is called within a MP table.
- ISR tables: ISR in these tables will be called in case of an interrupt generated by the motion control chip. Not all Macro commands can be added to the ISR table in order to guaranty that the execution of ISR is finished in a short time interval.

The maximum of command lines provided by each Macro table is shown in the following figure (Figure 4).

Macro Type	Number of Macros	Number of Command Lines	Macro Names								
Interrupt Service Routine (ISR)	6	8	ISR1	ISR2	ISR3	ISR4	ISR5	ISR6			
	9	16	ISR7	ISR8	ISR9	ISR10	ISR11	ISR12	ISR13	ISR14	ISR15
	3	32	ISR16	ISR17	ISR18						
	2	64	ISR19	ISR20							
Motion Program (MP)	40	8	MP1	~	MP40						
	50	16	MP41	~	MP90						
	40	32	MP91	~	MP130						
	20	64	MP131	~	MP150						
	5	128	MP151	MP152	MP153	MP154	MP155				
	2	512	MP156	MP157							

Figure 4: Macro table definitions

## 9.1 Create MP Macro Program Codes

### 9.1.1 Start a MP Macro Program Codes Programming

```
eRET ETM_MP_CREATE(HANDLE hEtm, BYTE cardNo, BYTE mp_No)
```

#### Description:

Each Macro program MP has to start with an ETM\_MP\_CREATE command and the end of the MP have to be indicated with an ETM\_MACRO\_MP\_CLOSE command.

#### Category:

MODBUS sub\_function; RTC

#### Parameters:

Paramters	Description
<i>hEtm:</i>	TCP/IP connection handle
<i>cardNo:</i>	1 (ET-M8194H supports only one i-8094H module)
<i>mpNo:</i>	The following variables are supported: Macro Program number (MP1 ~ MP157)

#### Return:

0: Success; Others: Fail (Please refer to chapter 2.2)

#### MODBUS example:

```
ETM_MP_CREATE (hEtm, 1, MP21);  
//Write Macro Program into i-8094H.
```

The MODBUS command is listed as follows:

TID (hex)	PID (hex)	Field Length (hex)	UID (hex)	FC (hex)	St_Addr. (hex)	Word Count (hex)	Byte Count (hex)
00 01	00 00	00 0B	01	10	1F 40	00 02	04
Register[]		Value (hex)		Remarks			
0		0A C9		Sub_funciton code			
1		00 15		mpNo (MP21 = 21 = 0x15)			

Related example:

```
ETM_MP_CREATE(hEtm, 1, MP21); //Write #21 Macro Program into i-8094H.
//=====
//The following functions will not be executed, but will be written into
//i-8094H for further execution.
ETM_MACRO_SET_MAX_V(hEtm, 1, AXIS_XYZU, 20000);
//The maximum speed of all axes is 20K PPS.
ETM_MACRO_NORMAL_SPEED(hEtm, 1, AXIS_XYZU, 0);
//Set symmetric T-curve for XYZU axes on module.
ETM_MACRO_SET_V(hEtm, 1, AXIS_XYZU, 2000);
//set the speed of all axes on module 1 to be 2000 PPS.
ETM_MACRO_SET_A(hEtm, 1, AXIS_XYZU, 1000);
//set the acceleration of XYZU axes to be 1000 PPS/sec
ETM_MACRO_SET_SV(hEtm, 1, AXIS_XYZU, 2000);
//set the start speed of XYZU axes to be 2000 PPS.
ETM_MACRO_SET_AO(hEtm,1, AXIS_XYZU, 9);
//set the number of remaining offset pulses for XYZU axes to be 9 pulses.
ETM_MACRO_FIXED_MOVE(hEtm, 1, AXIS_XYZU, 10000);
//move XYZU axes to be 10000 pulses.
ETM_MACRO_MP_CLOSE(hEtm, 1);
// module 1 finish, write Macro Program into i-8094H
//=====
```

## 9.1.2 End a MP Macro Program Codes Programming

※ eRET ETM\_MACRO\_MP\_CLOSE (HANDLE *hEtm*, BYTE *cardNo*)

### Description:

Indicate the end of a MP Macro program. This command is only used together with ETM\_MP\_CREATE to define an MP program. Otherwise, it will be ignored.

### Category:

MODBUS sub\_function; MP

### Parameters:

Paramters	Description
<i>hEtm</i> :	TCP/IP connection handle
<i>cardNo</i> :	1 (ET-M8194H supports only one i-8094H module)

### Return:

0: Success; Others: Fail (Please refer to chapter 2.2)

### MODBUS example:

```
ETM_MACRO_MP_CLOSE (hEtm, 1);
// module 1 finish, write Macro Program into i-8094H
```

The MODBUS command is listed as follows:

TID (hex)	PID (hex)	Field Length (hex)	UID (hex)	FC (hex)	St_Addr. (hex)	Word Count (hex)	Byte Count (hex)
00 01	00 00	00 09	01	10	1F 40	00 01	02
Register[]		Value (hex)		Remarks			
0		0C CA		Sub_funciton code			

### 9.1.3 MP Macro Program Execution

**eRET ETM\_MP\_CALL (HANDLE *hEtm*, BYTE *cardNo*, BYTE *mpNo*)**

✘ **eRET ETM\_MACRO\_MP\_CALL (HANDLE *hEtm*, BYTE *cardNo*, BYTE *mpNo*)**

#### Description:

Calls and execute a specific Macro Program stored in the non-volatile memory of the i-8094H. Within an MP program, up to 6 nested MP\_CALL function calls are allowed. For MP, the maximum nested Macro Program call can be up to 7. For ISR, no nested program call is allowed.

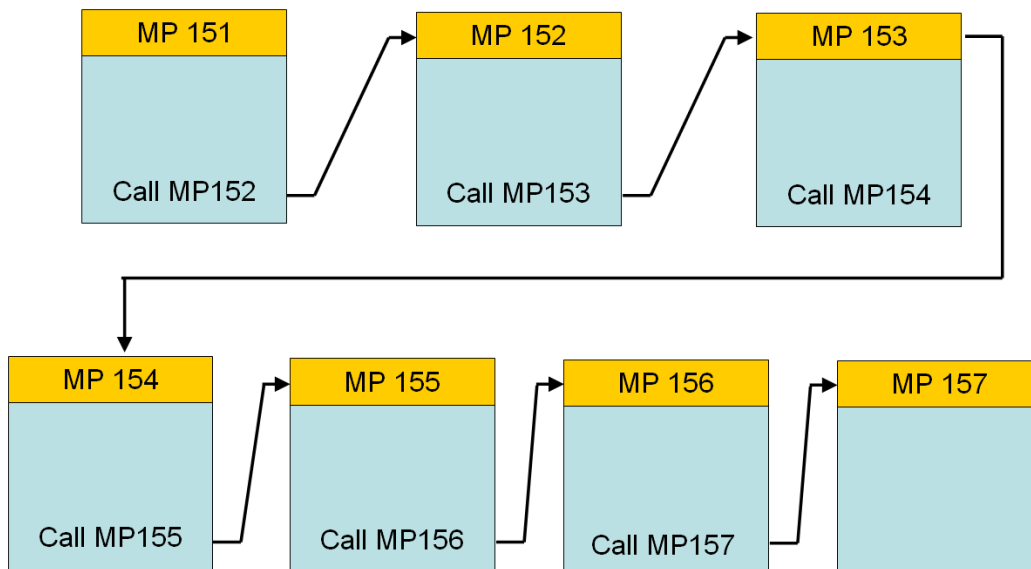

#### Category:

MODBUS table, MODBUS sub\_function; RTC and MP.

#### Parameters:

Paramters	Description
<i>hEtm</i> :	TCP/IP connection handle
<i>cardNo</i> :	1 (ET-M8194H supports only one i-8094H module)
<i>mpNo</i> :	The following variables are supported: Macro Program number (MP1 ~ MP157)

#### Return:

0: Success; Others: Fail (Please refer to chapter 2.2)

Remark:

The Sub\_function code of ETM\_MP\_CALL is 0A CB.

The Sub\_function code of ETM\_MACRO\_MP\_CALL is 0C CB.

MODBUS example:

//The true value of MPn = n; therefore, MP21 = 21 = 0x15.

ETM\_MP\_CALL (hEtm, 1, MP21); // Execute the MP21 on i-8094H

The MODBUS command is listed as follows:

TID (hex)	PID (hex)	Field Length (hex)	UID (hex)	FC (hex)	St_Addr. (hex)	Word Count (hex)	Byte Count (hex)
00 01	00 00	00 0B	01	10	1F 40	00 02	04
Register[]		Value (hex)		Remarks			
0		0A CB/0C CB		Sub_function code			
1		00 15		mpNo (MP21 = 21 = 0x15)			

The other method to call MPn is writing the MPn to the pre-defined holding register 8.

The MODBUS command is listed as follows:

TID (hex)	PID (hex)	Field Length (hex)	UID (hex)	FC (hex)	St_Addr. (hex)	Word Count (hex)	Byte Count (hex)
00 01	00 00	00 09	01	10	00 08	00 01	02
Register[]		Value (hex)		Remarks			
0		15		mpNo (MP21 = 21 = 0x15)			

Related example:

ETM\_MP\_CREATE(hEtm, 1, MP21); //Write #21 Macro Program into i-8094H.

//=====

//The following functions will not be executed, but will be written into //i-8094H for further execution.

ETM\_MACRO\_SET\_MAX\_V(hEtm, 1, AXIS\_XYZU, 20000);

//The maximum speed of the axis is 20K PPS.

ETM\_MACRO\_NORMAL\_SPEED(hEtm, 1, AXIS\_XYZU, 0);

//Set symmetric T-curve for XYZU axes on module.

ETM\_MACRO\_SET\_V(hEtm, 1, AXIS\_XYZU, 2000);

//set the speed of all axes on module 1 to be 2000 PPS.

ETM\_MACRO\_SET\_A(hEtm, 1, AXIS\_XYZU, 1000);

//set the acceleration of XYZU axes to be 1000 PPS/sec.

ETM\_MACRO\_SET\_SV(hEtm, 1, AXIS\_XYZU, 2000);

//set the start speed of XYZU axes to be 2000 PPS.

ETM\_MACRO\_SET\_AO(hEtm, 1, AXIS\_XYZU, 9);

```
//set the number of remaining offset pulses for XYZU axes to be 9 pulses.  
ETM_MACRO_FIXED_MOVE(hEtm, 1, AXIS_XYZU, 10000);  
//move XYZU axes to be 10000 pulses.  
ETM_MACRO_MP_CLOSE(hEtm, 1);  
// module 1 finish, write Macro Program into i-8094H  
//=====  
ETM_MP_CALL(hEtm, 1, MP21); // Execute the MP21 on i-8094H
```

## 9.2 Create ISR Macro Program Codes

### 9.2.1 Start a ISR Macro Program Codes Programming

```
eRET ETM_MP_ISR_CREATE(HANDLE hEtm, BYTE cardNo, BYTE  
isr_No)
```

#### Description:

ISR Macro table are being called by hardware interrupts generated by the motion control chip (e.g. exceeding hardware or software limit, driving has finished or when a compare condition has been met). To ensure that the API in an ISR are executed completely in a short time, no nested Macro calls, MP\_FOR loop and MP\_STOP\_WAIT are allowed inside an ISR.

Each ISR program has to be created by calling an ETM\_MP\_ISR\_CREATE command and ended by an ETM\_MACRO\_MP\_ISR\_CLOSE command.

#### Category:

MODBUS sub\_function; RTC

#### Parameters:

Parameters	Description
<i>hEtm:</i>	TCP/IP connection handle
<i>cardNo:</i>	1 (ET-M8194H supports only one i-8094H module)
<i>isr_No:</i>	The following variables are supported: ISR Macro Program number (ISR1 ~ ISR20)

#### Return:

0: Success; Others: Fail (Please refer to chapter 2.2)

#### MODBUS example:

```
ETM_MP_ISR_CREATE (hEtm, 1, ISR1);  
//Write ISR Macro program into i-8094H.
```

The MODBUS command is listed as follows:

TID (hex)	PID (hex)	Field Length (hex)	UID (hex)	FC (hex)	St_Addr. (hex)	Word Count (hex)	Byte Count (hex)
00 01	00 00	00 0B	01	10	1F 40	00 02	04
Register[]		Value (hex)		Remarks			
0		0ACD		<i>Sub_function code</i>			
1		00 01		<i>isr_No (ISR1 = 1 = 0x01)</i>			



## 9.2.2 End a ISR Macro Program Codes Programming

**Δ eRET ETM\_MACRO\_MP\_ISR\_CLOSE (HANDLE *hEtm*, BYTE *cardNo*)**

### Description:

This function indicates the end of an ISR program. Every ISR program must contain this command as the last command to indicate the end of the ISR program.

### Category:

MODBUS sub\_function; ISR

### Parameters:

Paramters	Description
<i>hEtm</i> :	TCP/IP connection handle
<i>cardNo</i> :	1 (ET-M8194H supports only one i-8094H module)

### Return:

0: Success; Others: Fail (Please refer to chapter 2.2)

### MODBUS example:

```
ETM_MACRO_MP_ISR_CLOSE (hEtm, 1);
// finish the writing of ISR Macro Program for i-8094H in slot 1
```

The MODBUS command is listed as follows:

TID (hex)	PID (hex)	Field Length (hex)	UID (hex)	FC (hex)	St_Addr. (hex)	Word Count (hex)	Byte Count (hex)
00 01	00 00	00 09	01	10	1F 40	00 01	02
Register[]		Value (hex)		Remarks			
0		0C CE		Sub_funciton code			

### 9.2.3 ISR Maro Program (ISR) Execution

**eRET ETM\_MP\_ISR\_CALL (HANDLE *hEtm*, BYTE *cardNo*, BYTE *isrNo*)**

**Description:**

This function is used for calling an ISR Macro program. Usually, ISR Macro tables are called by hardware interrupts. The purpose of this function is to test an ISR program.

**Category:**

MODBUS table, MODBUS sub\_function; ISR.

**Parameters:**

Paramters	Description
<i>hEtm</i> :	TCP/IP connection handle
<i>cardNo</i> :	1 (ET-M8194H supports only one i-8094H module)
<i>isrNo</i> :	The following variables are supported: ISR Macro Program number (ISR1 ~ ISR20)

**Return:**

0: Success; Others: Fail (Please refer to chapter 2.2)

**MODBUS example:**

*//The true value of ISRn = n; therefore, ISR1 = 1 = 0x1.*  
 ETM\_MP\_ISR\_CALL (*hEtm*, 1, *ISR1*); *// Execute the ISR1*

**The MODBUS command is listed as follows:**

TID (hex)	PID (hex)	Field Length (hex)	UID (hex)	FC (hex)	St_Addr. (hex)	Word Count (hex)	Byte Count (hex)
00 01	00 00	00 0B	01	10	1F 40	00 02	04
Register[]		Value (hex)		Remarks			
0		0A CF		<i>Sub_functicon code</i>			
1		00 01		<i>isrNo (ISR1 = 1 = 0x1)</i>			

## 9.3 User Defined Variables

### 9.3.1 Assign Macro variable a value

```
※Δ eRET ETM_MACRO_SET_VAR (HANDLE hEtm, BYTE cardNo, long  
varNo, long data)
```

#### Description:

Assign a Macro variable VARn (n = 0, 1, 2 ...) an integer value. It is also possible to assign the variable a value from another variable. This API acts as an assignment operator similar to the following statements:

VARn = VARm

VARn = Value

#### Category:

MODBUS table, MODBUS sub\_function; MP and ISR.

#### Parameters:

Paramters	Description
<i>hEtm:</i>	TCP/IP connection handle
<i>cardNo:</i>	1 (ET-M8194H supports only one i-8094H module)
<i>varNo:</i>	The following variables are supported: MACRO variable (VAR0 ~ VAR511)
<i>data:</i>	The following inputs are supported: Value (-2,000,000,000 ~ +2,000,000,000) or MACRO variable (VAR0 ~ VAR511)

#### Return:

0: Success; Others: Fail (Please refer to chapter 2.2)

#### MODBUS example:

```
//The address of VARn = 0x7FFF0000 + n; therefore, the address of VAR1 is  
// 0x7FFF0001.
```

```
ETM_MACRO_SET_VAR(hEtm, 1, VAR1, 100); // VAR1 = 100
```

The MODBUS command is listed as follows:

TID (hex)	PID (hex)	Field Length (hex)	UID (hex)	FC (hex)	St_Addr. (hex)	Word Count (hex)	Byte Count (hex)
00 01	00 00	00 11	01	10	1F 40	00 05	0A
Register[]		Value (hex)		Remarks			
0		0C D2		<i>Sub_funciton code</i>			
1		7F FF		<i>MSW address of varNo</i>			
2		00 01		<i>LSW address of varNo</i>			
3		00 00		<i>MSW of data</i>			
4		00 64		<i>LSW of data (100 = 0x64)</i>			

### 9.3.2 Get Command Return Value

```
※Δ eRET ETM_MACRO_SET_RVAR (HANDLE hEtm, BYTE cardNo, long  
varNo)
```

#### Description:

Assign the return value of the preceding function to a Macro variable VARn (n = 0, 1, 2 ...), where VARn = return value of preceding function (the value will be automatically casted to (long)).

The command reads the return values of the following commands:

- ETM\_MACRO\_GET\_LP
- ETM\_MACRO\_GET\_EP
- ETM\_MACRO\_ABS\_GET\_POSITION
- ETM\_MACRO\_GET\_HOME\_SEARCH\_STATE
- ETM\_MACRO\_GET\_ERROR
- ETM\_MACRO\_GET\_ERROR\_CODE
- ETM\_MACRO\_FRNET\_IN
- ETM\_MACRO\_FRNET\_READ
- ETM\_MACRO\_GET\_LATCH
- ETM\_MACRO\_GET\_DI\_ALL
- ETM\_MACRO\_GET\_DI
- ETM\_MACRO\_GET\_DI\_SIGNAL

#### Category:

MODBUS sub\_function; MP and ISR.

#### Parameters:

Paramters	Description
<i>hEtm:</i>	TCP/IP connection handle
<i>cardNo:</i>	1 (ET-M8194H supports only one i-8094H module)
<i>varNo:</i>	The following variables are supported: MACRO variable (VAR0 ~ VAR511)

#### Return:

0: Success; Others: Fail (Please refer to chapter 2.2)

#### MODBUS example:

```
// The address of VARn = 0x7FFF0000 + n; therefore, the address of VAR5  
// is 0x7FFF0005.  
ETM_MACRO_SET_RVAR(hEtm, 1, VAR5);
```

The MODBUS command is listed as follows:

TID (hex)	PID (hex)	Field Length (hex)	UID (hex)	FC (hex)	St_Addr. (hex)	Word Count (hex)	Byte Count (hex)
00 01	00 00	00 0D	01	10	1F 40	00 03	06
Register[]		Value (hex)		Remarks			
0		0C D3		<i>Sub_functon code</i>			
1		7F FF		<i>MSW address of varNo</i>			
2		00 05		<i>LSW address of varNo</i>			

Related example:

```

//The following commands show how to use Macro commands to store the
//logic position in a variable.
ETM_MP_CREATE(hEtm, 1, MP1); //Write #1 Macro Program into i-8094H.
ETM_MACRO_GET_LP(hEtm, 1, AXIS_X);
//Reads the LP value of the X axis on module 1.
ETM_MACRO_SET_RVAR(hEtm, 1, VAR5);
//Assign the return value of ETM_MACRO_GET_LP to VAR5
//( VAR5 = LP value)
ETM_MACRO_MP_CLOSE(hEtm, 1);
// module 1 finish, write Macro Program into i-8094H

```

## 9.4 Simple Calculations

※Δ eRET ETM\_MACRO\_VAR\_CALCULATE (HANDLE *hEtm*, BYTE *cardNo*, long *varNo*, BYTE *Operator*, long *varNo1*, long *varNo2*)

### Description:

Basic two parameter (value) calculations:

**varNo+**      *varNo1*      =      *varNo2*  
**varNo-**      *varNo1*      =      *varNo2*  
**varNo\***      *varNo1*      =      *varNo2*  
**varNo/**      *varNo1*      =      *varNo2*  
**varNo&**      *varNo1*      =      *varNo2*  
**varNo|**      *varNo1*      =      *varNo2*

### Category:

MODBUS sub\_function; MP and ISR.

### Parameters:

Paramters	Description
<i>hEtm</i> :	TCP/IP connection handle
<i>cardNo</i> :	1 (ET-M8194H supports only one i-8094H module)
<i>varNo</i> :	The first operand for this calculation. The following operand inputs are supported: Value (-2,000,000,000 ~ +2,000,000,000) or MACRO variable (VAR0 ~ VAR511)
<i>Operator</i> :	'+' addition '-' subtraction '*' multiplication '/' division(rounding down to the nearest integer) '&' AND operator ' ' OR operator
<i>varNo1</i> :	The second operand of the calculation. The following operand inputs are supported: Value (-2,000,000,000 ~ +2,000,000,000) or MACRO variable (VAR0 ~ VAR511)
<i>varNo2</i> :	MACRO variable (VAR0 ~ VAR511) which stores the result of the calculation

### Return:

0: Success; Others: Fail (Please refer to chapter 2.2)

### MODBUS example:

The address of VARn = 0x7FFF0000 + n;  
For example the address of VAR2 = 0x7FFF0002.

The ASCII code of operator:

Operator	ASCII (dec)	ASCII (hex)
'+'	43	2B
'_'	45	2D
'*'	42	2A
'/'	47	2F
'&'	38	26
' '	124	7C

```
ETM_MACRO_VAR_CALCULATE (hEtm, 1, VAR1, '+', VAR2, VAR3);
//VAR1 + VAR2 = VAR3
```

The MODBUS command is listed as follows:

TID (hex)	PID (hex)	Field Length (hex)	UID (hex)	FC (hex)	St_Addr. (hex)	Word Count (hex)	Byte Count (hex)
00 01	00 00	00 17	01	10	1F 40	00 08	10
Register[]		Value (hex)		Remarks			
0		0C D4		Sub_funciton code			
1		7F FF		MSW address of varNo			
2		00 01		LSW address of varNo			
3		00 2B		Operator : ASCII code of '+'			
4		7F FF		MSW address of varNo1			
5		00 02		LSW address of varNo1			
6		7F FF		MSW address of varNo2			
7		00 03		LSW address of varNo2			

Related example:

```
ETM_MP_CREATE(hEtm, 1, MP100); // Write #100 Macro Program into i-8094H.
```

```
//=====
//The following functions will not be executed, but will be written into
// i-8094H for further execution.
ETM_MACRO_SET_VAR(hEtm, 1, VAR1, 100); //VAR1 = 100
ETM_MACRO_SET_VAR (hEtm, 1, VAR2, 200); //VAR2 = 200
ETM_MACRO_SET_VAR (hEtm, 1, VAR10, 10); //VAR10 = 10
//-----
ETM_MACRO_FRNET_IN(hEtm, 1, 8);
ETM_MACRO_SET_RVAR(hEtm, 1, VAR6);
//VAR6 = current input of RA8 on module 1
//-----
ETM_MACRO_GET_LP(hEtm, 1, AXIS_X);
//Reads the LP value of the X axis on module 1.
ETM_MACRO_SET_RVAR(hEtm, 1, VAR5);
//VAR5 = LP value of the X axis on module 1.
```



```

//-----
ETM_MACRO_VAR_CALCULATE(hEtm, 1, VAR1, '+', VAR2, VAR3);
//VAR1 + VAR2 = VAR3
ETM_MACRO_VAR_CALCULATE (hEtm, 1, VAR3, '-', VAR1, VAR3);
//VAR3 - VAR1 = VAR3
ETM_MACRO_VAR_CALCULATE (hEtm, 1, VAR3, '**', VAR10, VAR2);
//VAR3 x VAR10 = VAR2
ETM_MACRO_VAR_CALCULATE (hEtm, 1, VAR3, '/', VAR2, VAR1);
//VAR3 / VAR2 = VAR1
//Results: VAR1 = 10; VAR2 = 200; VAR3 = 2,000; VAR10 = 10
ETM_MACRO_MP_CLOSE(hEtm, 1);
// module 1 finish, write #100 Macro Program into i-8094H
//=====

```

## 9.5 Command Loop (FOR~NEXT)

### 9.5.1 Start of FOR Loop Block

```
※ eRET ETM_MACRO_FOR (HANDLE hEtm, BYTE cardNo, long varNo)
```

#### Description:

The *varNo* specifies how many times the code between the ETM\_MACRO\_FOR command and the ETM\_MACRO\_NEXT command will be executed. The *varNo* parameter will be decreased until it reaches zero, and then the loop will be stopped. If the *varNo* is assigned to be a Macro VARn, this value of VARn represents the loop cycles and will be changed each time a loop is finished. An ETM\_MACRO\_EXIT\_FOR command can abort the current loop immediately if it is executed inside the loop. Up to six nested loops are supported: one outer loop and six inner loops.

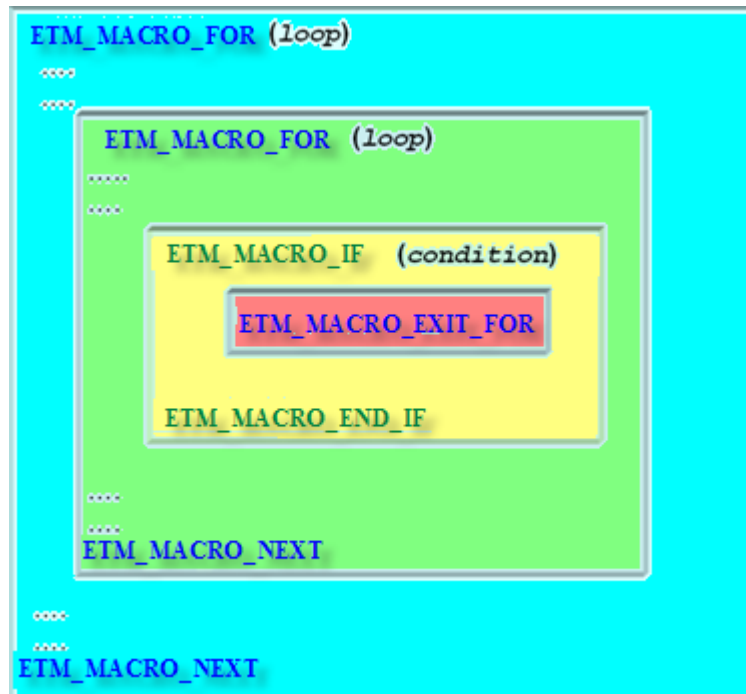

Figure 5: Basic loop application

#### Category:

MODBUS sub\_function; MP.

Parameters:

Paramters	Description
<i>hEtm:</i>	TCP/IP connection handle
<i>cardNo:</i>	1 (ET-M8194H supports only one i-8094H module)
<i>IValue:</i>	Specifies the cycle number. The following inputs are supported: Value (-2,000,000,000 ~ +2,000,000,000) or MACRO variable (VAR0 ~ VAR511)

Return:

0: Success; Others: Fail (Please refer to chapter 2.2)

MODBUS example:

*// The address of VARn = 0x7FFF0000 + n;*  
 For example, the address of VAR1 = 0x7FFF0001.  
 ETM\_MACRO\_FOR (hEtm, 1, VAR1);

The MODBUS command is listed as follows:

TID (hex)	PID (hex)	Field Length (hex)	UID (hex)	FC (hex)	St_Addr. (hex)	Word Count (hex)	Byte Count (hex)
00 01	00 00	00 0D	01	10	1F 40	00 03	06
Register[]		Value (hex)		Remarks			
0		0C D5		<i>Sub_funciton code</i>			
1		7F FF		<i>MSW address of IValue</i>			
2		00 01		<i>LSW address of IValue</i>			

Related example:

```

ETM_MP_CREATE(hEtm, 1, MP100); // Write #100 Macro Program into i-
8094H.
//=====
// The following functions will not be executed, but will be written into
// i-8094H for further execution.
ETM_MACRO_SET_MAX_V(hEtm, 1, AXIS_X, 20000);
//The maximum speed of the axis X is 20K PPS.
ETM_MACRO_NORMAL_SPEED(hEtm, 1, AXIS_X, 0);
//Set symmetric T-curve for axis X
ETM_MACRO_SET_V(hEtm, 1, AXIS_X, 2000);
//set the speed of axis X to be 2000 PPS.
ETM_MACRO_SET_A(hEtm, 1, AXIS_X, 1000);
//set the acceleration of axis X to be 1000 PPS/Sec
ETM_MACRO_SET_SV(hEtm, 1, AXIS_X, 2000);
//set the start speed of axis X to be 2000 PPS.
ETM_MACRO_SET_AO(hEtm, 1, AXIS_X, 0);
//set the number of remaining offset pulses for axis X to be 0 PPS.
    
```

```

//-----
ETM_MACRO_SET_VAR(hEtm, 1, VAR1, 100); //VAR1 = 100 °
ETM_MACRO_FOR(hEtm, 1, VAR1);
//enable axis X to move back and forward 1,000 Pulse, loop for 100 times.
//or input the instant operating value ETM_MACRO_FOR(hEtm, 1, 100).
ETM_MACRO_FIXED_MOVE(hEtm, 1, AXIS_X, 1000);
//move axis X to be 1000 pulses.
ETM_MACRO_FIXED_MOVE(hEtm, 1, AXIS_X, -1000);
//move axis X to be -1000 pulses.
ETM_MACRO_NEXT(hEtm, 1);
ETM_MACRO_MP_CLOSE(hEtm, 1);
// module 1 finish, Macro Program is written into i-8094H
//=====
ETM_MP_CALL(hEtm, 1, MP100);
// call module 1 i-8094H, execute Macro Program #100.

```

## 9.5.2 End of FOR Loop Block

※ eRET ETM\_MACRO\_NEXT (HANDLE *hEtm*, BYTE *cardNo*)

### Description:

This function indicates the end of the ETM\_MACRO\_FOR loop. Every loop has to start with ETM\_MACRO\_FOR statement and end with ETM\_MACRO\_NEXT statement.

### Category:

MODBUS sub\_function; MP.

### Parameters:

Paramters	Description
<i>hEtm</i> :	TCP/IP connection handle
<i>cardNo</i> :	1 (ET-M8194H supports only one i-8094H module)

### Return:

0: Success; Others: Fail (Please refer to chapter 2.2)

### MODBUS example:

ETM\_MACRO\_NEXT (*hEtm*, 1);

The MODBUS command is listed as follows:

TID (hex)	PID (hex)	Field Length (hex)	UID (hex)	FC (hex)	St_Addr. (hex)	Word Count (hex)	Byte Count (hex)
00 01	00 00	00 09	01	10	1F 40	00 01	02
Register[]		Value (hex)		Remarks			
0		0C D6		<i>Sub_function code</i>			

### 9.5.3 FOR Loop Block Exit

※ eRET ETM\_MACRO\_EXIT\_FOR(HANDLE *hEtm*, BYTE *cardNo*)

**Description:**

An ETM\_MACRO\_EXIT\_FOR command can abort the current loop immediately if it is executed inside the loop.

**Category:**

MODBUS sub\_function; MP.

**Parameters:**

Paramters	Description
<i>hEtm</i> :	TCP/IP connection handle
<i>cardNo</i> :	1 (ET-M8194H supports only one i-8094H module)

**Return:**

0: Success; Others: Fail (Please refer to chapter 2.2)

**MODBUS example:**

ETM\_MACRO\_EXIT\_FOR (*hEtm*, 1);

The MODBUS command is listed as follows:

TID (hex)	PID (hex)	Field Length (hex)	UID (hex)	FC (hex)	St_Addr. (hex)	Word Count (hex)	Byte Count (hex)
00 01	00 00	00 09	01	10	1F 40	00 01	02
Register[]		Value (hex)		Remarks			
0		0C DE		Sub_functon code			

## 9.6 Conditional Command (IF~ELSE)

### 9.6.1 IF Condition

※Δ eRET ETM\_MACRO\_IF (HANDLE *hEtm*, BYTE *cardNo*, long *varNo*, WORD *Operator*, long *varNo1*)

#### Description:

A conditional checking ETM\_MACRO\_IF has to end the whole block with an ETM\_MACRO\_END\_IF statement. One ETM\_MACRO\_ELSE statement can be added inside the conditional block and will be executed if the ETM\_MACRO\_IF statement turns out to be false. Up to 6 nested IF statements are supported (one outer and six inner IF conditions).

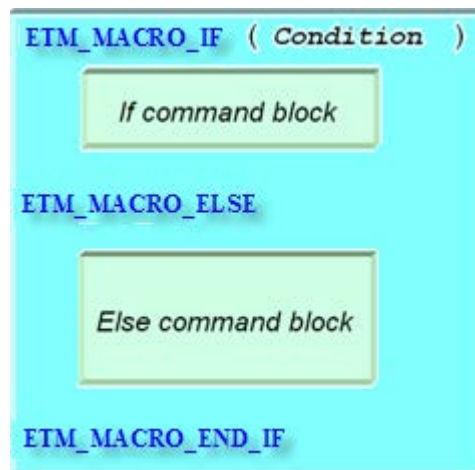

Figure 6: ETM\_MACRO\_IF application structure

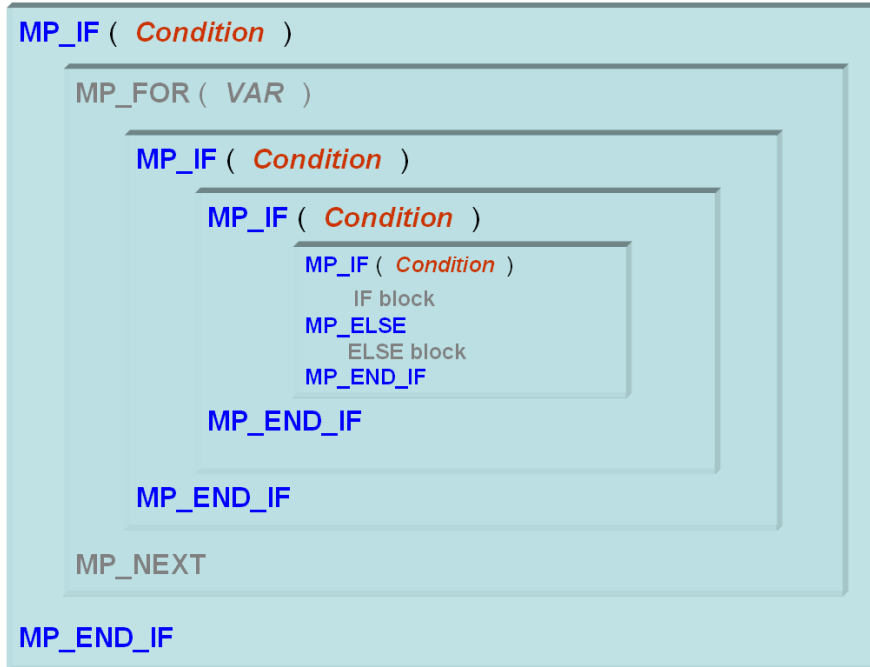

Figure 7: Nested IF statements

**Category:**

MODBUS sub\_function; MP and ISR.

**Parameters:**

Paramters	Description																					
<i>hEtm:</i>	TCP/IP connection handle																					
<i>cardNo:</i>	1 (ET-M8194H supports only one i-8094H module)																					
<i>varNo:</i>	The first variable of the comparison expressions. Can either be a variable of long type (range: -2,000,000,000 ~ +2,000,000,000) or MACRO variable (VAR0 ~ VAR511)																					
<i>Operator:</i>	Comparison operators: <table border="1" style="margin-left: 20px;"> <thead> <tr> <th>string</th> <th>constant</th> <th>Description</th> </tr> </thead> <tbody> <tr> <td>"&lt;"</td> <td>LT</td> <td>Less than (ASCII code = 0x003C)</td> </tr> <tr> <td>"&gt;"</td> <td>GT</td> <td>Greater than (ASCII code = 0x003E)</td> </tr> <tr> <td>"&lt;="</td> <td>LE</td> <td>Less than or equal to (ASCII code = 0x3D3C)</td> </tr> <tr> <td>"&gt;="</td> <td>GE</td> <td>Greater than or equal to (ASCII code = 0x3D3E)</td> </tr> <tr> <td>"=="</td> <td>EQ</td> <td>Equal to (ASCII code = 0x3D3D)</td> </tr> <tr> <td>"!="</td> <td>NE</td> <td>Not equal to (ASCII code = 0x3D21)</td> </tr> </tbody> </table>	string	constant	Description	"<"	LT	Less than (ASCII code = 0x003C)	">"	GT	Greater than (ASCII code = 0x003E)	"<="	LE	Less than or equal to (ASCII code = 0x3D3C)	">="	GE	Greater than or equal to (ASCII code = 0x3D3E)	"=="	EQ	Equal to (ASCII code = 0x3D3D)	"!="	NE	Not equal to (ASCII code = 0x3D21)
string	constant	Description																				
"<"	LT	Less than (ASCII code = 0x003C)																				
">"	GT	Greater than (ASCII code = 0x003E)																				
"<="	LE	Less than or equal to (ASCII code = 0x3D3C)																				
">="	GE	Greater than or equal to (ASCII code = 0x3D3E)																				
"=="	EQ	Equal to (ASCII code = 0x3D3D)																				
"!="	NE	Not equal to (ASCII code = 0x3D21)																				



<b>varNo1:</b>	The second variable of the comparison expressions. Can either be a variable of long type (range: -2,000,000,000 ~ +2,000,000,000) or MACRO variable (VAR0 ~ VAR511)
----------------	---

**Return:**

0: Success; Others: Fail (Please refer to chapter 2.2)

**MODBUS example:**

The ASCII code of operator.

Operator	ASCII (dec)	ASCII (hex)
<	60	003C
<=	15676	3D3C
>	62	003E
>=	15678	3D3E
==	15677	3D3D
=	61	003D
!=	15649	3D21
!	33	0021

ETM\_MACRO\_IF (hEtm, 1, VAR1, "<=", VAR2);  
 //The double quotes ("") is required for Operator parameter.

The MODBUS command is listed as follows:

TID (hex)	PID (hex)	Field Length (hex)	UID (hex)	FC (hex)	St_Addr. (hex)	Word Count (hex)	Byte Count (hex)
00 01	00 00	00 13	01	10	1F 40	00 06	0C
Register[]	Value (hex)	Remarks					
0	0C D7	Sub_funciton code					
1	7F FF	MSW address of varNo					
2	00 01	LSW address of varNo					
3	3C 3D	Operator (0x3C3D → "<=")					
4	7F FF	MSW address of varNo1					
5	00 02	LSW address of varNo1					

**Related example:**

```
ETM_MP_CREATE(hEtm, 1, MP100); // Write #100 Macro Program into i-8094H.
//=====
// The following functions will not be executed, but will be written into
// i-8094H for further execution.
ETM_MACRO_SET_MAX_V(hEtm, 1, AXIS_X, 20000);
//The maximum speed of the axis X is 20K PPS.
```

```

ETM_MACRO_NORMAL_SPEED(hEtm, 1, AXIS_X, 0);
//Set symmetric T-curve for axis X.
ETM_MACRO_SET_V(hEtm, 1, AXIS_X, 2000);
//set the speed of axis X to be 2000 PPS.
ETM_MACRO_SET_A(hEtm, 1, AXIS_X, 1000);
//set the acceleration of axis X to be 1000 PPS/sec
ETM_MACRO_SET_SV(hEtm, 1, AXIS_X, 2000);
//set the start speed of axis X to be 2000 PPS.
ETM_MACRO_SET_AO(hEtm, 1, AXIS_X, 0);
//set the number of remaining offset pulses for axis X to be 0 PPS.
//-----
ETM_MACRO_SET_VAR(hEtm, 1, VAR1, 100); //VAR1 = 100 °
ETM_MACRO_SET_VAR(hEtm, 1, VAR2, 200); //VAR2 = 200 °
ETM_MACRO_IF(hEtm, 1, VAR1, "<", VAR2);
ETM_MACRO_FIXED_MOVE(hEtm, 1, AXIS_X, 1000);
//command to move axis X for 1000 pulses.
ETM_MACRO_ELSE(hEtm, 1);
ETM_MACRO_FIXED_MOVE(hEtm, 1, AXIS_X, -1000);
// command to move axis X for -1000 pulses.
ETM_MACRO_END_IF(hEtm, 1);
ETM_MACRO_MP_CLOSE(hEtm, 1);
// module 1, Macro Program #100 is written into i-8094H
//=====
ETM_MP_CALL(hEtm, 1, MP100);
// execute Macro Program #100 of module 1.

```

## 9.6.2 ELSE Statement

※Δ eRET ETM\_MACRO\_ELSE (HANDLE *hEtm*, BYTE *cardNo*)

### Description:

The block under ETM\_MACRO\_ELSE will be executed if the conditional statement of ETM\_MACRO\_IF is false; otherwise, it will be ignored.

### Category:

MODBUS sub\_function; MP and ISR.

### Parameters:

Paramters	Description
<i>hEtm</i> :	TCP/IP connection handle
<i>cardNo</i> :	1 (ET-M8194H supports only one i-8094H module)

### Return:

0: Success; Others: Fail (Please refer to chapter 2.2)

### MODBUS example:

ETM\_MACRO\_ELSE (*hEtm*, 1);

The MODBUS command is listed as follows:

TID (hex)	PID (hex)	Field Length (hex)	UID (hex)	FC (hex)	St_Addr. (hex)	Word Count (hex)	Byte Count (hex)
00 01	00 00	00 09	01	10	1F 40	00 01	02
Register[]		Value (hex)		Remarks			
0		0C D8		<i>Sub_functon code</i>			

### 9.6.3 End of IF Statement

※Δ eRET ETM\_MACRO\_END\_IF (HANDLE *hEtm*, BYTE *cardNo*)

**Description:**

This function indicates the end of a conditional block. A conditional block always begins with an ETM\_MACRO\_IF statement and ends with this function.

**Category:**

MODBUS sub\_function; MP and ISR.

**Parameters:**

Paramters	Description
<i>hEtm</i> :	TCP/IP connection handle
<i>cardNo</i> :	1 (ET-M8194H supports only one i-8094H module)

**Return:**

0: Success; Others: Fail (Please refer to chapter 2.2)

**MODBUS example:**

ETM\_MACRO\_END\_IF (*hEtm*, 1);

The MODBUS command is listed as follows:

TID (hex)	PID (hex)	Field Length (hex)	UID (hex)	FC (hex)	St_Addr. (hex)	Word Count (hex)	Byte Count (hex)
00 01	00 00	00 09	01	10	1F 40	00 01	02
Register[]		Value (hex)		Remarks			
0		0C D9		Sub_funciton code			

## 9.7 Jump Commands (GOTO-LABEL)

### 9.7.1 GOTO Statement

※ eRET ETM\_MACRO\_GOTO(HANDLE *hEtm*, BYTE *cardNo*, BYTE *lableNo*)

#### Description:

The ETM\_MACRO\_GOTO Macro statement is a label based statement that transfers the control directly to the labeled location in the Macro program. The goto statement is very useful while working with nested loops. It enables to leave all nested nested loops with one command by jumping from the inner loop to an ETM\_MP\_LABEL position outside the nested loop.

#### Limitations:

- A Maximum of four ETM\_MACRO\_LABEL position can be defined.
- It is NOT allowed to jump into a loop block. Therefore, the ETM\_MACRO\_LABEL statement can not be located inside a loop.
- Jumping into an MP\_IF block is prohibited. ETM\_MACRO\_LABEL command is not allowed to be located inside an ETM\_MACRO\_IF block.
- You can only jump within a Macro table and it is not allowed to jump from one Macro table (e.g. MP1) to another Macro table (e.g. MP2).
- Can not be used inside an ISR Macro table.

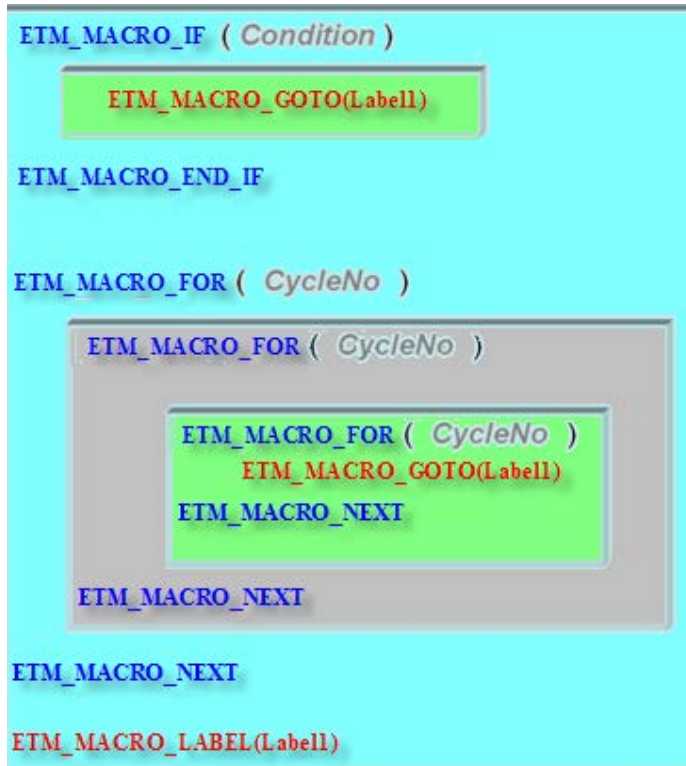

Figure 8: ETM\_MACRO\_GOTO application

**Category:**

MODBUS sub\_function; only inside MP Macro table allowed.

**Parameters:**

Paramters	Description
<i>hEtm:</i>	TCP/IP connection handle
<i>cardNo:</i>	1 (ET-M8194H supports only one i-8094H module)
<i>labelNo:</i>	Only four labels are supported for each MP Macro table: 0, 1, 2, 3 (LABEL0, LABEL1, LABEL2, LABEL3)

**Return:**

0: Success; Others: Fail (Please refer to chapter 2.2)

**MODBUS example:**

ETM\_MACRO\_GOTO (hEtm, 1, 3);

The MODBUS command is listed as follows:

TID (hex)	PID (hex)	Field Length (hex)	UID (hex)	FC (hex)	St_Addr. (hex)	Word Count (hex)	Byte Count (hex)
00 01	00 00	00 0B	01	10	1F 40	00 02	04
Register[]		Value (hex)		Remarks			
0		0C DF		Sub_function code			
1		00 03		labelNo (3 → 0x03)			

## 9.7.2 LABEL Statement

※ eRET ETM\_MACRO\_LABEL(**HANDLE** *hEtm*, **BYTE** *cardNo*, **BYTE** *lableNo*)

### Description:

This function indicates the target position of a jump statement. The ETM\_MACRO\_LABEL can be positioned before or after ETM\_MACRO\_GOTO Macro statement. In a Macro only one ETM\_MACRO\_LABEL with the same Label number can be used but more than one ETM\_MACRO\_GOTO with the same Label number is allowed.

### Note:

ETM\_MACRO\_LABEL command is not allowed inside a MP\_IF or MP\_FOR block.

### Category:

MODBUS sub\_function; only inside MP Macro table allowed.

### Parameters:

Paramters	Description
<i>hEtm</i> :	TCP/IP connection handle
<i>cardNo</i> :	1 (ET-M8194H supports only one i-8094H module)
<i>lableNo</i> :	Only four labels are supported for each MP Macro table: 0, 1, 2, 3 (LABEL0, LABEL1, LABEL2, LABEL3)

### Return:

0: Success; Others: Fail (Please refer to chapter 2.2)

### MODBUS example:

ETM\_MACRO\_LABEL (hEtm, 1, 3);

The MODBUS command is listed as follows:

TID (hex)	PID (hex)	Field Length (hex)	UID (hex)	FC (hex)	St_Addr. (hex)	Word Count (hex)	Byte Count (hex)
00 01	00 00	00 0B	01	10	1F 40	00 02	04
Register[]		Value (hex)		Remarks			
0		0C E1		Sub_function code			
1		00 03		labelNo (3 → 0x03)			

## 9.8 Timer

※ eRET ETM\_MACRO\_TIMER (HANDLE *hEtm*, BYTE *cardNo*, long *varNo*)

### Description:

Delay the execution of the following Macro commands. The execution of the following Macro commands is held until the specified time has elapsed.

### Category:

MODBUS sub\_function; for MP Macro table.

### Parameters:

Paramters	Description
<i>hEtm</i> :	TCP/IP connection handle
<i>cardNo</i> :	1 (ET-M8194H supports only one i-8094H module)
<i>varNo</i> :	Time in milliseconds. The following inputs are supported: Value (0 ~ +2,000,000,000) ms, or MACRO variables (VAR0 ~ VAR511)

### Return:

0: Success; Others: Fail (Please refer to chapter 2.2)

### MODBUS example:

ETM\_MACRO\_TIMER (*hEtm*, 1, 200);  
//delay the execution of the function for 200ms.

The MODBUS command is listed as follows:

TID (hex)	PID (hex)	Field Length (hex)	UID (hex)	FC (hex)	St_Addr. (hex)	Word Count (hex)	Byte Count (hex)
00 01	00 00	00 0D	01	10	1F 40	00 03	06
Register[]	Value (hex)	Remarks					
0	0C DA	Sub_functon code					
1	00 00	MSW of <i>varNo</i>					
2	00 C8	LSW of <i>varNo</i> (200 = 0xC8)					



## 9.9 Wait Until Motion Command has been Executed

<b>eRET</b> ETM_STOP_WAIT( <b>HANDLE</b> <i>hEtm</i> , <b>BYTE</b> <i>cardNo</i> , <b>BYTE</b> <i>axis</i> )
✘ <b>eRET</b> ETM_MACRO_STOP_WAIT( <b>HANDLE</b> <i>hEtm</i> , <b>BYTE</b> <i>cardNo</i> , <b>BYTE</b> <i>axis</i> )

### Description:

The command ensures that the motion command for the assigned axis is completed before the next macro command is being executed. The command waits until the motion control chip has finished outputting pulses for the designated axis then continues to process the following command.

### Category:

MODBUS sub\_function; RTC, MP.

### Parameters:

Paramters	Description
<i>hEtm</i> :	TCP/IP connection handle
<i>cardNo</i> :	1 (ET-M8194H supports only one i-8094H module)
<i>axis</i> :	Axis or axes (Please refer to Table 3) The axis can be either X, Y, Z or U (1 or 2 or 4 or 8).

### Return:

0: Success; Others: Fail (Please refer to chapter 2.2)

### Remark:

The Sub\_function code of ETM\_STOP\_WAIT is 0A DB.  
The Sub\_function code of ETM\_MACRO\_STOP\_WAIT is 0C DB.

### MODBUS example:

ETM\_STOP\_WAIT (*hEtm*, 1, *AXIS\_Y*);

The MODBUS command is listed as follows:

TID (hex)	PID (hex)	Field Length (hex)	UID (hex)	FC (hex)	St_Addr. (hex)	Word Count (hex)	Byte Count (hex)
00 01	00 00	00 0B	01	10	1F 40	00 02	04
Register[]		Value (hex)		Remarks			
0		0A DB/0C DB		Sub_functon code			
1		00 02		axis (2 → <i>AXIS_Y</i> )			

## 9.10 Exit Macro Program

✘ **Δ eRET ETM\_MACRO\_EXIT\_MACRO (HANDLE *hEtm*, BYTE *cardNo*)**

### Description:

The execution of a MP or ISR Macro table will be stopped and the table will be exited as soon as the Macro interpreter encounters this command. If a nested Macro call is being executed, this command causes the command interpreter to jump to calling Macro layer one level up (Figure 9). If the top level Macro layer encounters ETM\_MACRO\_EXIT\_MACRO, the execution of Macro commands terminates all together. Only in case of a new hardware interrupt occurs, the relevant ISR Macro will be executed. This command behaves similarly to the ETM\_MACRO\_MP\_CLOSE command except that it can be called at any place inside a Macro table, whereas the ETM\_MACRO\_MP\_CLOSE command has to be placed at the end of a Macro table.

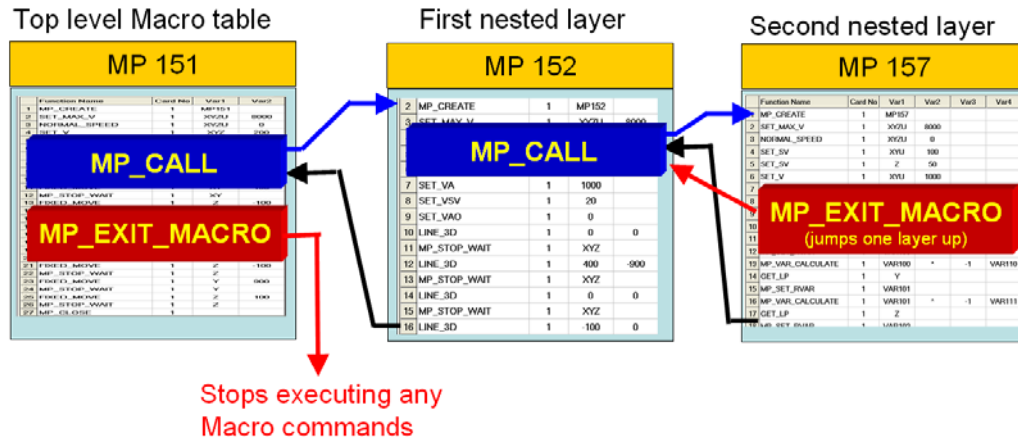

Figure 9: Exiting macro tables

### Category:

MODBUS sub\_function; MP and ISR.

### Parameters:

Paramters	Description
<i>hEtm</i> :	TCP/IP connection handle
<i>cardNo</i> :	1 (ET-M8194H supports only one i-8094H module)

### Return:

0: Success; Others: Fail (Please refer to chapter 2.2)

**MODBUS example:**

**ETM\_MACRO\_EXIT\_MACRO (hEtm, 1);**

**The MODBUS command is listed as follows:**

TID (hex)	PID (hex)	Field Length (hex)	UID (hex)	FC (hex)	St_Addr. (hex)	Word Count (hex)	Byte Count (hex)
00 01	00 00	00 09	01	10	1F 40	00 01	02
Register[]		Value (hex)		Remarks			
0		0C DD		<i>Sub_funciton code</i>			

## 9.11 Terminate all Macro Executions

**eRET ETM\_MP\_TERMINATE (HANDLE *hEtm*, BYTE *cardNo*)**

**※Δ eRET ETM\_MACRO\_MP\_TERMINATE (HANDLE *hEtm*, BYTE *cardNo*)**

### Description:

All currently running MP or ISR Macro program will be terminated immediately. After all the Macro programs have been terminated successfully, the command automatically resets itself so that new Macro programs can be executed. This command is intended for emergent situation where any Macro execution needs to be stopped immediately. This command can be called both inside a Macro program and outside a Macro program, for example, by the host controller or a remote HMI controller.

### Warning:

This command does not stop the motion chip from continuing executing the motion command received prior to the ETM\_MP\_TERMINATE command. In order to stop the motion chip from outputting pulse signals, one of the following commands has to be called:

- ETM\_STOP\_SUDDENLY
- ETM\_STOP\_SLOWLY
- ETM\_VSTOP\_SUDDENLY
- ETM\_VSTOP\_SLOWLY

Therefore, if it required stopping motion and Macro commands from execution then one of the above four STOP commands as well as the ETM\_MP\_TERMINATE has to be called.

### Category:

MODBUS sub\_function; RTC, MP, ISR.

### Parameters:

Parameters	Description
<i>hEtm</i> :	TCP/IP connection handle
<i>cardNo</i> :	1 (ET-M8194H supports only one i-8094H module)

### Return:

0: Success; Others: Fail (Please refer to chapter 2.2)

### MODBUS example:

```
ETM_MP_TERMINATE (hEtm, 1);
```

The MODBUS command is listed as follows:

TID (hex)	PID (hex)	Field Length (hex)	UID (hex)	FC (hex)	St_Addr. (hex)	Word Count (hex)	Byte Count (hex)
00 01	00 00	00 09	01	10	1F 40	00 01	02
Register[]		Value (hex)		Remarks			
0		0A E2/0C E2		Sub_funciton code			

## 9.12 Get Macro Download Status

```
eRET ETM_GET_MP_DOWNLOAD_STATUS(HANDLE hEtm, BYTE
    cardNo, MpDownloadInfo *pInfo)

typedef struct
{
    WORD MpNo;
    WORD IsrNo;
    WORD wCmd;
    WORD wLineNo;
    WORD wErrCode;
}MpDownloadInfo;
```

### Description:

This function confirms whether the previous MP or ISR macro download procedure was successful. It indicate which Macro type has been downloaded (MP or ISR) and its number. In case of a download error the type of error, the command and Macro line number will be indicated.

### Category:

MODBUS table; RTC.

### Parameters:

Paramters	Description
<i>hEtm:</i>	TCP/IP connection handle
<i>cardNo:</i>	1 (ET-M8194H supports only one i-8094H module)
<i>pInfo:</i>	<p><b><i>MpNo:</i></b> indicates the MP Macro number (1-MP1, 2 - MP2 ...). If no MP Macro has been downloaded MpNo will be zero (MpNo=0).</p> <p><b><i>IsrNo:</i></b> indicates the latest ISR Macro number downloaded (1-ISR1, 2 -ISR2 ...). If no ISR Macro has been downloaded IsrNo will be zero (IsrNo=0).</p> <p><b><i>wCmd:</i></b> code of the command in the Macro program which caused the error (see command code chapter 12.3).</p> <p><b><i>wLineNo:</i></b> the line number in the Macro program. The first line has the number zero.</p> <p><b><i>wErrCode:</i></b> error code describing the cause of macro download failure:</p>

- **0x00:** no error occurred. Download was succesful.
- **0x01:** number of commands lines exceeds the quantity of line provide by the corresponding Macro table.

**IF command errors:**

- **0x02:** Number of nested MP\_IF statements exceeds the limit of six inner nested MP\_IFs.
- **0x03:** MP\_ELSE command outside MP\_IF block
- **0x04:** MP\_END\_IF command outside MP\_IF block. The MP\_END\_IF statement has not got a corresponding MP\_IF statement.
- **0x05:** MP\_IF block has not been closed by MP\_END\_IF command.
- **0x06:** Wrong MP\_IF conditional operator.

**FOR loop command errors:**

- **0x07:** Number of nested MP\_FOR exceeds the limit.
- **0x08:** MP\_EXIT\_FOR command outside MP\_FOR loop. The corresponding MP\_FOR command is missing.
- **0x09:** MP\_NEXT command outside MP\_FOR block. The corresponding MP\_FOR command is missing.
- **0x0A:** MP\_FOR block has not been closed with a MP\_NEXT command.

**GOTO command errors:**

- **0x0B:** Label number is being used more than once.
- **0x0C:** MP\_LABEL inside a MP\_IF block. Jumping into a MP\_IF block is prohibited.
- **0x0D:** MP\_LABEL inside a MP\_FOR block. Jumping into a MP\_FOR block is prohibited.
- **0x0E:** MP\_GOTO command has NO corresponding MP\_LABEL command.
- **0x0F:** MACRO (MP or ISR) command not defined: Command will not be written to the FRAM.
- **0x10:** Wrong MP\_VAR\_CALCULATE operator.

**Return:**

**0: Success; Others: Fail (Please refer to chapter 2.2)**

**MODBUS example:**

```
MpDownloadInfo MpInfo;
ETM_GET_MP_DOWNLOAD_STATUS(hEtm, 1, &MpInfo);
```

**MODBUS request:**

TID (hex)	PID (hex)	Field Length (hex)	UID (hex)	FC (hex)	St_Addr. (hex)	Word Count (hex)
00 01	00 00	00 06	01 (Card No.)	04	00 6E (110)	00 05

**MODBUS response:**

TID (hex)	PID (hex)	Field Length (hex)	UID (hex)	FC (hex)	Byte Count (hex)	Registers (hex)
00 01	00 00	00 0D	01	04	0A	See next table

Register []	Value (hex)	Remarks
0	00 02	<i>MpNo</i> : MP number (e.g. MP2)
1	00 00	<i>IsrNo</i> : ISR number (no ISR Macro has been downloaded)
2	0A D6	<i>wCmd</i> : command code (here MP_NEXT)
3	00 09	<i>wLineNo</i> : command line within Macro table (line number 9)
4	00 09	<i>wErrCode</i> : error code describing the kind of error (here: MP_NEXT command outside MP_FOR block. The corresponding MP_FOR command is missing.)



## 9.13 Change Velocity on the Fly

**eRET ETM\_CHANGE\_VEL\_ON\_FLY (HANDLE hEtm, BYTE cardNo, BYTE axis, DWORD data)**

### Description:

If a Macro program is running inside the i-8094H, the remote host can call this function to change the drive speed set by the Macro program. Once the new drive speed has been set the drive will accelerate to the specified velocity.

### Category:

MODBUS sub\_function; RTC.

### Parameters:

Paramters	Description
<i>hEtm:</i>	TCP/IP connection handle
<i>cardNo:</i>	1 (ET-M8194H supports only one i-8094H module)
<i>axis:</i>	Axis or axes (Please refer to Table 3) The axis can be either X, Y, Z or U (1 or 2 or 4 or 8).
<i>data:</i>	Drive speed (Please refer to 2.5 for maximum speed) PPS.

### Return:

0: Success; Others: Fail (Please refer to chapter 2.2)

### Remark:

The Sub\_function code of ETM\_CHANGE\_VEL\_ON\_FLY is 0x0A43.

### MODBUS example:

```
ETM_CHANGE_VEL_ON_FLY (hEtm, 1, AXIS_X, 120000L);
//set the speed for the X axis on module 1 to 120000 PPS.
```

### The MODBUS command is listed as follows:

TID (hex)	PID (hex)	Field Length (hex)	UID (hex)	FC (hex)	St_Addr. (hex)	Word Count (hex)	Byte Count (hex)
00 01	00 00	00 0F	01	10	1F 40	00 04	08
Register[]		Value (hex)		Remarks			
0		0A 43		Sub_function code			
1		00 01		axis (1 = AXIS_X)			
2		00 01		MSW of data			
3		D4 C0		LSW of data (120000 = 0x1D4C0)			

---

## 10 Stand Alone Controller

---

The ET-8194H together with an FRnet DI can operate as a standalone controller without being connected to a Modbus master. Each FRnet DI can be assigned to a motion program stored in the ET-M8194H as a Macro program. By triggering an FRnet DI event the corresponding Macro program starts executing. Only one Macro program can be triggered at a time.

In the following the procedure for configuring the ET-M8194H to support FRnet DI triggering will be described:

### FRnet Triggered MACRO Execution

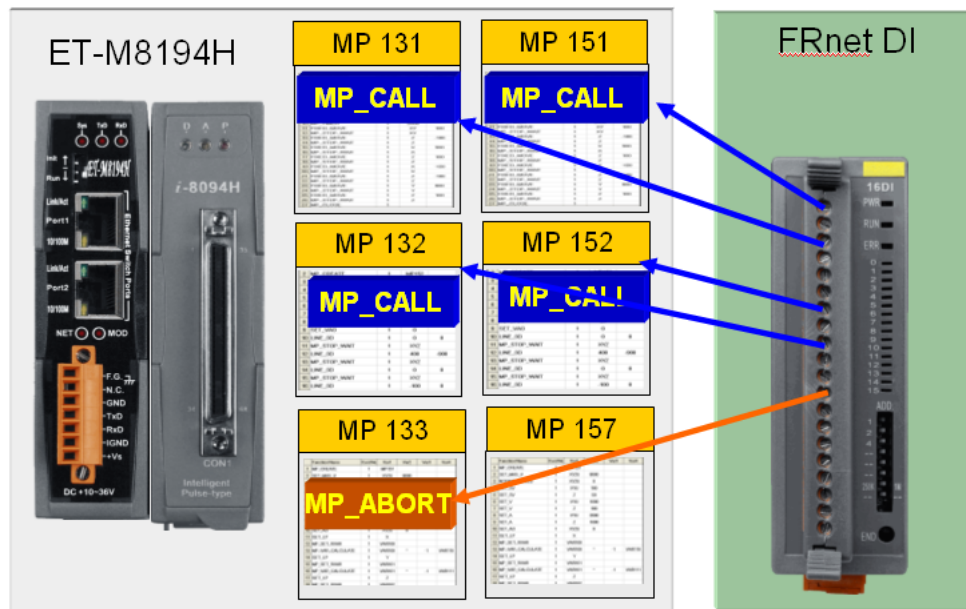

- **Step 1:**  
Write a Macro program and download it to the ET-M8194H (see chapter 9).
- **Step 2:**  
Use the EzMove Utility to select which DI channel to use for FRnet

triggered Macro execution. Connect to the ET-M8194H and open the “FRnet DI Setting” window (Setting → FRnet DI...). For each DI channel select the trigger condition and the corresponding event type.

FRnet DI		Setting		
Group	Channel	Trigger Condition	Event Type	Axis
8	0	OFF to ON	MP1	
	1	ON to OFF	MP18	
	2	Change	MP137	
	3	Change	Abort Command	
	4	OFF to ON	Abort Macro Program	
	5	OFF to ON	MP35	
	6	ON	Hold Drive	X
	7	ON	Hold Drive	X
	8	ON	Hold Drive	Y
	9	ON	Hold Drive	Z
	10	ON	Hold Drive	U
	11	None	None	XY
	12	None	None	XZ
	13	None	None	XU
	14	None	None	YZ
9	0	None	None	
	1	None	None	
	2	None	None	
	3	None	None	
	4	None	None	
	5	None	None	
	6	None	None	

The ET-M8194H defines the following DI trigger conditions:

Trigger Condition
None
None
OFF
ON
ON to OFF
OFF to ON
Change

If the DI channel is not being used for event triggering then set it to “None”. The DI triggered event can be a Macro execution, pause or abort of the current Macro execution execution, or stop of motion execution

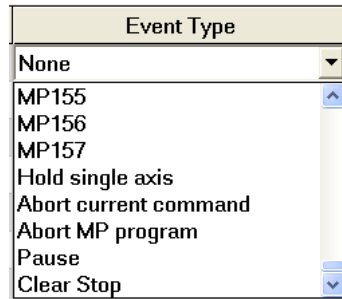

- **Step 3:**  
Download the DI trigger setting to the ET-M8194H by clicking “Send Table”
- **Step 4:**  
Enable FRnet DI triggering by clicking the check box. Now the ET-M8194H is ready to process FRnet DI events

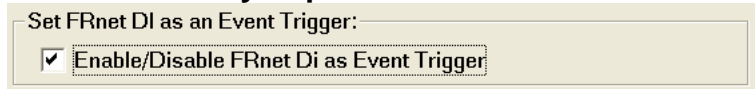

It is important to notice that only one Macro program can run at a time. Therefore if an FRnet DI event is generated to execute a new Macro program while a Macro program is already running then the event first waits until the current Macro program has finished executing before starting the next one.

---

# 11 Library Version

---

## 11.1 Modbus P824 Library

```
eRET ETM_GET_ETM8194H_FIRMWARE_VERSION (HANDLE hEtm,  
DWORD* ETM8194H_Ver);
```

### Description:

This function reads the Modbus library version of the ET-M8194H.

### Parameters:

Paramters	Description
<i>hEtm</i> :	TCP/IP connection handle
<i>ETM8194H_Ver</i>	Version number Example: 0x03000000 → Version 3.0

### MODBUS example:

```
DWORD ETM8194H_Ver;  
HANDLE hEtm;  
ETM_GET_ETM8194H_FIRMWARE_VERSION(hEtm,  
&ETM8194H_Ver);
```

### MODBUS request:

TID (hex)	PID (hex)	Field Length (hex)	UID (hex)	FC (hex)	St_Addr. (hex)	Word Count (hex)
00 01	00 00	00 06	01	04	00 52	00 02

### MODBUS response:

TID (hex)	PID (hex)	Field Length (hex)	UID (hex)	FC (hex)	Byte Count (hex)	Version (hex) High Word	Version (hex) Low Word
00 01	00 00	00 07	01	04	04	02 00	00 00

## 11.2 i-8094H Library Version

```
eRET ETM_GET_i8094H_FIRMWARE_VERSION (HANDLE hEtm,
    DWORD* i8094H_Ver);
```

### Description:

This function reads the i-8094H library version of the ET-M8194H.

### Parameters:

Paramters	Description
<i>hEtm</i> :	TCP/IP connection handle
<i>i8094H_Ver</i>	Version number Example: 0x02210300 <ul style="list-style-type: none"> <li>▪ PCB 2.21</li> <li>▪ The Low WORD (last two hex number) represents the i-8094H firmware Version: 3.00</li> </ul>

### MODBUS example:

```
DWORD i8094H_Ver;
HANDLE hEtm;
ETM_GET_i8094H_FIRMWARE_VERSION(hEtm, &i8094H_Ver);
```

### MODBUS request:

TID (hex)	PID (hex)	Field Length (hex)	UID (hex)	FC (hex)	St_Addr. (hex)	Word Count (hex)
00 01	00 00	00 06	01	04	00 54	00 02

### MODBUS response:

TID (hex)	PID (hex)	Field Length (hex)	UID (hex)	FC (hex)	Byte Count (hex)	Version (hex) High Word	Version (hex) Low Word
00 01	00 00	00 07	01	04	04	02 21	02 01

## 11.3 ET-M8194H DLL Version

```
WORD ETM_GET_DLL_VERSION (void);
```

### Description:

This function reads the read ET-M8194H API Library version. This function is an internal function and can be called without connecting to the ET-M8194H.

0x0100 means the version number is 1.00. The high byte is the major version number and the low byte is the minor version number.

---

## 12 Appendix

---

### 12.1 MODBUS Input Registers

Use Modbus function code 4 to read the input register table. The table addresses defined below is zero-based but for some PLCs and HMIs the addresses are one-based. This means the one based device use the address one to access the register table at index zero. The format of the one-based input register table is 3xxx, x is digital number, '3' represents the table and is defined for Input registers; and xxx is the one-based address of a register.

In PLC, the first input register defined at address 30001 is the same as the first register at address 0 shown in the table below. Most PLC systems which addresses do not start from zero can be referred as one-based system. The following tables will only show zero-based addresses.

When a value is represented by two registers data, the order of most significant WORD (MSW) and least significant WORD (LSW) can be determined by reading the current WORD order setting. The WORD order setting is defined at address 14 (zero-based) in holding register table. If WORD order is set to 0, the first register (lower address) represents the high-word (**MSW**) and the second register is low-word (**LSW**).



## 12.1.1 Read FRnet DI/O

Appendix table 1: FRnet DI/O (PLC address: 30001 to 30016)

Read FRnet DIO				
Variable Name		Address (zero based)	Type	Comment
FRnet DO	Group 0	0	R	Read the FRnet DO group 0 (16-bit)
	Group 1	1	R	Read the FRnet DO group 1 (16-bit)
	Group 2	2	R	Read the FRnet DO group 2 (16-bit)
	Group 3	3	R	Read the FRnet DO group 3 (16-bit)
	Group 4	4	R	Read the FRnet DO group 4 (16-bit)
	Group 5	5	R	Read the FRnet DO group 5 (16-bit)
	Group 6	6	R	Read the FRnet DO group 6 (16-bit)
	Group 7	7	R	Read the FRnet DO group 7 (16-bit)
FRnet DI	Group 8	8	R	Read the FRnet DI group 8 (16-bit)
	Group 9	9	R	Read the FRnet DI group 9 (16-bit)
	Group 10	10	R	Read the FRnet DI group 10 (16-bit)
	Group 11	11	R	Read the FRnet DI group 11 (16-bit)
	Group 12	12	R	Read the FRnet DI group 12 (16-bit)
	Group 13	13	R	Read the FRnet DI group 13 (16-bit)
	Group 14	14	R	Read the FRnet DI group 14 (16-bit)
	Group 15	15	R	Read the FRnet DI group 15 (16-bit)

## 12.1.2 Read Motion Chip DI Status of Daughterboard

Appendix table 2: DI Status of Daughterboard (PLC address: 30017 to 30020)

Read DI Status (of Daughterboard)				
Variable Name	Address (zero based)	Type	Comment	
DI ALL	X-Axis	16	R	All DI status of AXIS-X, If the individual DI is needed, read X_DI_0 ~ X_DI_9.
	Y-Axis	17	R	All DI status of AXIS-Y, If the individual DI is needed, please read Y_DI_0 ~ Y_DI_9.
	Z-Axis	18	R	All DI status of AXIS-Z, If the individual DI is needed, please read Z_DI_0 ~ Z_DI_9.
	U-Axis	19	R	All DI status of AXIS-Z, If the individual DI is needed, please read U_DI_0 ~ U_DI_9.

### 12.1.3 Read Error Code

Appendix table 3: Error Code (PLC address: 30021 to 30026)

Read Error Code				
Variable Name		Address (zero based)	Type	Comment
ERROR CODE	X-Axis	20	R	The error occurred on AXIS-X. Please refer to ETM_GET_ERROR_CODE() for detailed information.
	Y-Axis	21	R	The error occurred on AXIS-Y. Please refer to ETM_GET_ERROR_CODE() for detailed information.
	Z-Axis	22	R	The error occurred on AXIS-Z. Please refer to ETM_GET_ERROR_CODE() for detailed information.
	U-Axis	23	R	The error occurred on AXIS-U. Please refer to ETM_GET_ERROR_CODE() for detailed information.
MP Call number		24	R	Current running MP or ISR number
EMERGENCY_STOP state		25	R	Shows the current emergency state 1- emergency stop enabled 0 – no emergency disabled

## 12.1.4 Read Logic and Encoder Position, Acceleration, Velocity

**Appendix table 4: Logic and Encoder Position, Acceleration, Velocity (PLC address: 30027 to 30058)**

Motion Status				
	Variable Name	Address (zero based)	Type	Comment
Logic Position	X	26-27	R	Logical position of X-axis.
	Y	28-29	R	Logical position of Y-axis.
	Z	30-31	R	Logical position of Z-axis.
	U	32-33	R	Logical position of U-axis.
Encoder Position	X	34-35	R	Encoder feedback position of X-axis. It takes two registers.
	Y	36-37	R	Encoder feedback position of Y-axis. It takes two registers.
	Z	38-39	R	Encoder feedback position of Z-axis. It takes two registers.
	U	40-41	R	Encoder feedback position of U-axis. It takes two registers.
Current velocity	X	42-43	R	Current velocity of X-axis. It takes two registers.
	Y	44-45	R	Current velocity of Y-axis. It takes two registers.
	Z	46-47	R	Current velocity of Z-axis. It takes two registers.
	U	48-49	R	Current velocity of U-axis. It takes two registers.
Current Acceleration	X	50-51	R	Current acceleration of X-axis. It takes two registers.
	Y	52-53	R	Current acceleration of Y-axis. It takes two registers.
	Z	54-55	R	Current acceleration of Z-axis. It takes two registers.
	U	56-57	R	Current acceleration of U-axis. It takes two registers.

## 12.1.5 Read Stop Status

Appendix table 5: Stop Status (PLC address: 30059 to 30062)

Variable Name		Address (zero based)	Type	Comment
Stop Status	X	58	R	1:stop, 0: moving
	Y	59	R	1:stop, 0: moving
	Z	60	R	1:stop, 0: moving
	U	61	R	1:stop, 0: moving

## 12.1.6 Read Latch

Appendix table 6: Read Latch (PLC address: 30063 to 30070)

Variable Name		Address (zero based)	Type	Comment
Latch	X	62-63	R	Value in X-axis latch register long type
	Y	64-65	R	Value in Y-axis latch register long type
	Z	66-67	R	Value in Z-axis latch register long type
	U	68-69	R	Value in U-axis latch register long type

## 12.1.7 Read Error State and Free Buffer Size

Appendix table 7: Error State and Free Buffer Size (PLC address: 30071 to 30072)

Variable Name	Address (zero based)	Type	Comment
ERROR_STATE	70	R	1: error occurred; 0: no error
FREE_BUFFER_SIZE	71	R	Get the available block-numbers in Buffer. The maximum block is 30.

## 12.1.8 Read i-8094H Interrupt

Appendix table 8: i-8094H Interrupt (PLC address: 30073 to 30081)

i-8094H Interrupt ET-M8194H (Return Interrupt RINT)			
Variable Name	Address (zero based)	Type	Comment
RINT_STATE_ALL	72	R	Read the RINT state. For detailed, please refer to the descriptions of <b>ETM_RINT_WAIT()</b> and <b>ETM_RINT_ENABLE()</b> .
Line_Scan_Completed	73	R	Bit0 of RINT_STATE
MP_Completed	74	R	Bit1 of RINT_STATE
User-Defined_RINT	75	R	Bit2 of RINT_STATE
Continuous_Inp_Interrupt	76	R	Bit3 of RINT_STATE
.....Undefined	77	--	0
.....Undefined	78	--	0
Axes_Error	79	R	Bit6 of RINT_STATE
Module_Error	80	R	Bit7 of RINT_STATE



## 12.1.9 Read Firmware Version

Appendix table 9: Firmware Version (PLC address: 30082 to 30087)

Others			
Variable Name	Address (zero based)	Type	Comment
i-8094H Module ID	81	R	i-8094H : 0x <b>44</b> i-8094A : 0x <b>55</b>
ET-M8194H Firmware Version	82-83	R	0x <b>0100</b> 0000 means Ver : 1.00
i-8094H Firmware Version	84-85	R	0x02210201 <ul style="list-style-type: none"> <li>▪ High Word for PCB version</li> <li>▪ Low WORD represents the i-8094H firmware Version:</li> </ul> // Example: <ul style="list-style-type: none"> <li>▪ High WORD               <ul style="list-style-type: none"> <li>○ PCB Version 2.21</li> </ul> </li> <li>▪ Low WORD               <ul style="list-style-type: none"> <li>○ 0201-&gt;02 major version, 01-&gt; minor version number</li> </ul> </li> </ul>
TCN	86	R	<b>T</b> otal Modbus Client <b>C</b> onnection <b>N</b> umber

## 12.1.10 Read DI Signal of Daughterboard

**Appendix Table 110: DI Status of Daughterboard (PLC address: 30017 to 30020)**

Read DI Signal (of Daughterboard)				
Variable Name	Address (zero based)	Type	Comment	
DI ALL	X-Axis	88	R	All DI signal of AXIS-X, If the individual DI is needed, read X_DI_SIG_0 ~ X_DI_SIG_7.
	Y-Axis	89	R	All DI signal of AXIS-Y, If the individual DI is needed, please read Y_DI_SIG_0 ~ Y_DI_SIG_7.
	Z-Axis	90	R	All DI signal of AXIS-Z, If the individual DI is needed, please read Z_DI_SIG_0 ~ Z_DI_SIG_7.
	U-Axis	91	R	All DI signal of AXIS-Z, If the individual DI is needed, please read U_DI_SIG_0 ~ U_DI_SIG_7.

## 12.1.11 Read Absolute Logic Position

Appendix table 101: Absolute Logic Position (PLC address: 30093 to 30100)

Motion Status				
Variable Name		Address (zero based)	Type	Comment
Absolute Logic Position	X	160-161	R	Absolute logical position of X-axis.
	Y	162-163	R	Absolute logical position of Y-axis.
	Z	164-165	R	Absolute logical position of Z-axis.
	U	166-167	R	Absolute logical position of U-axis.

## 12.1.12 Read ET-M8194H and i-8094H State

Appendix table 12: ET-M8194H and i-8094H State (PLC address: 30101 to 30103)

Current state of the ET-M8194H and i-8094H			
Variable Name	Address (zero baed)	Type	Comment
ET-M8194H state	100	R	The current state of the ET-M8194H module: 0- ready for receiving new RTC and Macro commands 1- ETM is in an MACRO download state (MPn) 2- ETM is in an MACRO download state (ISRn)
i-8094H state	101	R	The current state of the i-8094H module: 3- ready for receiving new RTC commands 4- Calling the initialization table 5- Initialization finished 6- downloading MACRO commands (MP or ISR commands) to the FRAM or is waiting for the next MACRO command 7- Macro download finished 8- MACRO program (MP) is being executed 9- MACRO program (MP) execution finished 10- Interrupt MACRO (ISR) program is being executed 11- Interrupt MACRO (ISR) execution finished 255- firmware is booting
Illegal Modbus function	102	R	Cause of the ILLIGAL FUNCTION Modbus exception response: 0- no error 1- function code not supported 2- Parameter value in NOT within defined range 3- No such command

			<p>4- More than the available command lines are used for the specific MACRO program (MPn or ISRn)</p> <p>5- A MP command is being used inside ISR MACRO.</p> <p>6- A ISR command is being used inside MP MACRO</p> <p>7- A RTC command is being used inside a MP or ISR MACRO</p> <p>8- A MP or ISR MACRO command is being used outside a MACRO program as real time command</p> <p><b>0xB1</b> - The max number of nested MP_IF commands has been exceeded</p> <p><b>0xB2</b> - MP_ELSE command outside MP_IF block</p> <p><b>0xB3</b> - MP_END_IF command outside MP_IF block</p> <p><b>0xB4</b> - MP_IF block has not been closed by MP_END_IF command</p> <p><b>0xB5</b> - Number of nested MP_FOR exceeds the limit</p> <p><b>0xB6</b> -MP_EXIT_FOR command outside MP_FOR loop</p> <p><b>0xB7</b> - MP_NEXT command outside MP_FOR block</p> <p><b>0xB8</b> - MP_FOR block has not been closed with a MP_NEXT command</p> <p><b>0xB9</b> - Label number is being used more than once</p> <p><b>0xBA</b> - MP_LABEL inside a MP_IF block. Jumping into a MP_IF block is prohibited</p> <p><b>0xBB</b> - MP_LABEL inside a MP_FOR block. Jumping into a MP_FOR block is prohibited</p> <p><b>0xBC</b> - MP_GOTO command has NO corresponding MP_LABEL command</p> <p><b>0xC0</b> - A DWORD is required but only one register has been received</p> <p><b>0xC1</b> -DPRAM of i-8094H is full</p> <p><b>0xC2</b> -Module not in slot</p> <p><b>0xC3</b> - A Macro program is currently being executed inside the i-8094H</p>
--	--	--	--

### 12.1.13 Macro Program Download Error Messages

Appendix table 113: Program Download Error Message (PLC address: 30111 to 30115)

Macro program download error message			
Variable Name	Address (zero based)	Type	Comment
Macro MP number (MPxx)	110	R	The last downloaded Macro MP program number since ET-M8194H power on.
Macro ISR number (ISRxx)	111	R	The last downloaded Macro ISR program number since ET-M8194H power on.
Command type	112	R	The number identifying the command. See sub function code. The register following the 8000 sub function register identifies the command.
Line number	113	R	The line number of the Macro program at which the error occurred
Error type	114	R	Describes the type of error

## 12.1.14 Macro Program Execution Error Messages

**Appendix table 124: Macro Program Execution Error Messages (PLC address: 30116 to 30120)**

Macro program execution error message			
Variable Name	Address (zero based)	Type	Comment
Macro MP number (MPxx)	115	R	The last downloaded Macro MP program number since ET-M8194H power on.
Macro ISR number (ISRxx)	116	R	The last downloaded Macro ISR program number since ET-M8194H power on.
Command type	117	R	The number identifying the command at which the error occurred. See sub function code. The register following the 8000 sub function register identifies the command.
Line number	118	R	The line number of the Macro program at which the error occurred
Error type	119	R	Describes the type of error

## 12.1.15 Motion Chip Triggered Interrupt

Appendix table 135: Motion Chip Triggered Interrupt (PLC address: 30131 to 30140)

Motion chip triggered interrupt				
<i>nINT</i>	Symbol	Address (zero based)	Type	Description
0	PULSE	130	R	Interrupt occurs when pulse is up.
1	P>=C-	131	R	Interrupt occurs when the value of logical / real position counter is larger than or equal to that of COMP- register.
2	P<C-	132	R	Interrupt occurs when the value of logical / real position counter is smaller than that of COMP- register.
3	P<C+	133	R	Interrupt occurs when the value of logical / real position counter is smaller than that of COMP+ register.
4	P>=C+	134	R	Interrupt occurs when the value of logical / real position counter is larger than or equal to that of COMP+ register.
5	C-END	135	R	Interrupt occurs at the end of the constant speed drive or completion of Acceleration Offset Pulse output
6	C-STA	136	R	Interrupt occurs at the start of the constant speed drive or begin of Acceleration Offset Pulse output
7	D-END	137	R	Interrupt occurs when the driving is finished
8	HMEND	138	R	Automatic home search terminated
9	SYNC	139	R	Synchronous action was activated



## 12.2 Holding Registers

Use Modbus function code 6 or 16 to write to the holding register(s) and function code 3 to read the registers. The table addresses defined below is zero-based. For some PLC or HMI, the addresses maybe show on their documents as 4xxxx, x is digital number. For example, 40001 to 49999. '4' represents the table is defined for holding registers; and xxxx is the address of a register.

In PLC, the first holding register defined at address 40001 is the same as the first register at address 0 shown in the following table. Most PLC systems which addresses do not start from zero can be referred as one-based system. The following tables will only show zero-based addresses. When PLC or HMI users configure their registers, they have to consider register number mapping problem carefully.

When a parameter needs two registers to store, such as DWORD, long, float, the order of MSW and LSW can be determined by setting a flag (WORD Order). WORD Order is defined at address 14 (zero-based) in holding register table. If WORD Order is set to 0, the first register (lower address) is high-word (**MSW**) and the second register is low-word (**LSW**).

R/W – read/write

## 12.2.1 FRnet DO

Appendix table 146: FRnet DO (PLC address: 40001 to 40008)

FRnet DO				
Variable Name		Address (zero base)	Type	Comment
FRnet DO	Group 0	0	R/W	Set/Read the FRnet DO group 0
	Group 1	1	R/W	Set/Read the FRnet DO group 1
	Group 2	2	R/W	Set/Read the FRnet DO group 2
	Group 3	3	R/W	Set/Read the FRnet DO group 3
	Group 4	4	R/W	Set/Read the FRnet DO group 4
	Group 5	5	R/W	Set/Read the FRnet DO group 5
	Group 6	6	R/W	Set/Read the FRnet DO group 6
	Group 7	7	R/W	Set/Read the FRnet DO group 7

## 12.2.2 Macro Call, FRnet Event and WORD Order Setting

Appendix table 157: Macro Call, FRnet Event and WORD Order Setting (PLC address: 40009 to 40015)

Variable Name	Address (zero based)	Type	Comment
CALL_MPn	8	R/W	This is a simple method to call MP. Write the MPn at this address, the corresponding MPn will be called. n=1-157
FRNet Event	9	--	Enable FRnet DI to generate events 0 – disable FRnet event trigger 1 – enable FRnet event trigger
Reserved	10-13	--	Not defined
WORD Order	14	R/W	This setting is relevant for DWORD, long, float variables:  0: Big endian WORD (reverse type). First register represents the most significant word the second register represents the least significant word  1: Small Endian WORD Most significant word is the second register

### 12.2.3 IP Address Setting

Appendix table 168: IP Address Setting (PLC address: 40021 to 40031)

IP Address Setting			
Variable Name	Address (zero based)	Type	Comment
Lock_IP	20 ~ 23	R/W	Lock/Read_Locked TCP Client IP
UnLock_IP	24	W	Unlock TCP Client IP
ET-M8194H_IP	25~26	R/W	Set ET-M8194H IP
ET-M8194H_Mask	27~28	R/W	Set ET-M8194H Mask
ET-M8194H_Gateway	29~30	R/W	Set ET-M8194H Gateway

## 12.2.4 Read/ Write Logic and Encoder Position, Acceleration, Velocity

**Appendix table 179: Logic and Encoder Position, Acceleration, Velocity  
(PLC address: 40091 to 40122)**

Motion Status				
Variable Name		Address (zero based)	Type	Comment
Absolute Position	X-Axis	82-83	R/W	Absolute position of X-axis.
	Y-Axis	84-85	R/W	Absolute position of Y-axis.
	Z-Axis	86-87	R/W	Absolute position of Z-axis.
	U-Axis	88-89	R/W	Absolute position of U-axis.
Logic Position (LP)	X-Axis	90-91	R/W	Logical position of X-axis.
	Y-Axis	92-93	R/W	Logical position of Y-axis.
	Z-Axis	94-95	R/W	Logical position of Z-axis.
	U-Axis	96-97	R/W	Logical position of U-axis.
Encoder Position (EP)	X-Axis	98-99	R/W	Encoder feedback position of X-axis.
	Y-Axis	100-101	R/W	Encoder feedback position of Y-axis.
	Z-Axis	102-103	R/W	Encoder feedback position of Z-axis.
	U-Axis	104-105	R/W	Encoder feedback position of U-axis.
Current Velocity (CV)	X-Axis	106-107	R	Current velocity of X-axis.
	Y-Axis	108-109	R	Current velocity of Y-axis.
	Z-Axis	110-111	R	Current velocity of Z-axis.
	U-Axis	112-113	R	Current velocity of U-axis.
Current Acceleration (CA)	X-Axis	114-115	R	Current acceleration of X-axis.
	Y-Axis	116-117	R	Current acceleration of Y-axis.
	Z-Axis	118-119	R	Current acceleration of Z-axis.
	U-Axis	120-121	R	Current acceleration of U-axis.

## 12.2.5 Read/ Write VAR Variables

Appendix table 20: VAR Variables (PLC address: 40301 to 41324)

Macro Variables			
Variable Name	Address (zero based)	Type	Comment
VAR0	300-301	R/W	Value of VAR0.
VAR1	302-303	R/W	Value of VAR1.
...	...		$VAR_n = 300 + 2 * n$ to $300 + 2 * n + 1$
VAR510	1320-1321	R/W	Value of VAR510.
VAR511	1322-1323	R/W	Value of VAR511.

## 12.2.6 Sub Function Code Definition

Appendix table 21: Sub Function Code Definition (PLC address: 48001 to 48101)

Motion Commands Sub Function Code 16			
Variable Name	Address (zero based)	Type	Comment
Sub_Function_Code	8000	W	The mapping of sub function code can refer to table in <b>section 12.3</b> .
Reg1	8001	W	The definitions of parameters depend on the sub functions. Please refer to the table in <b>section 12.3</b> .
Reg2	8002	W	Users can use the sub function call method to implement most of the motion functions, especially for setting functions.
Reg3	8003	W	For getting real-time information from modules, these tables in <b>section 12.1 and 12.2</b> are valuable.
Reg4	8004	W	Users can refer to examples in the functions description above to know how to set the parameters.
...			The basic rules of parameter definitions are : BYTE → one register (low-byte) WORD → one register DWORD → two registers long → two registers float → two registers
Reg100	8100	W	

## 12.3 Sub-Function Code Mapping Table

Please use the FC=16 to call the sub-functions; the related starting address is 8000 (zero-based). The following table lists the reference-section, Sub\_Function name and required-registers of the related sub-function-code.

Some code-fields are filled with xxxxxx; this means no sub-function-code is involved. Most of these functions are belong to the Getting command; the FC=3 or FC=4 will be used to get the needed information. Please refer to the MODBUS table in the section 12.1 and 12.2.

Appendix table 22: Sub Function Code mapping table

Section	Sub_Function	Code (Hex)	Code (Dec)	No. of registers
		reg(0)	reg(0)	
2.1.1	ETM_CONNECT	xxxxxx	xxxxxx	x
2.1.1	ETM_CONNECT_W	xxxxxx	xxxxxx	x
2.1.2	ETM_DISCONNECT	xxxxxx	xxxxxx	x
2.1.3	ETM_CONNECTION_STATE	xxxxxx	xxxxxx	x
2.1.4	ETM_MODBUS_CMD	xxxxxx	xxxxxx	x
2.1.5	ETM_SET_WORD_ORDER	xxxxxx	xxxxxx	x
2.1.6	ETM_GET_WORD_ORDER	xxxxxx	xxxxxx	x
3.2.1	ETM_RESET_CARD	0x0A0A	2570	1
3.2.2	ETM_CLEAR_CARD_BUFFER	0x0A0B	2571	1
3.3	ETM_SET_PULSE_MODE	0x0A0C	2572	3
3.3	ETM_MACRO_SET_PULSE_MODE	0x0C0C	3084	3
3.4	ETM_SET_MAX_V	0x0A0D	2573	4
3.4	ETM_MACRO_SET_MAX_V	0x0C0D	3085	4
3.5	ETM_SET_HLMT	0x0A0E	2574	4
3.5	ETM_MACRO_SET_HLMT	0x0C0E	3086	4
3.6	ETM_LIMITSTOP_MODE	0x0A0F	2575	3
3.6	ETM_MACRO_LIMITSTOP_MODE	0x0C0F	3087	3
3.7	ETM_SET_NHOME	0x0A10	2576	3
3.7	ETM_MACRO_SET_NHOME	0x0C10	3088	3
3.8	ETM_SET_HOME_EDGE	0x0A11	2577	3
3.8	ETM_MACRO_SET_HOME_EDGE	0x0C11	3089	3
3.9.1	ETM_SET_SLMT	0x0A12	2578	7
3.9.1	ETM_MACRO_SET_SLMT	0x0C12	3090	7
3.9.2	ETM_CLEAR_SLMT	0x0A13	2579	2



Section	Sub_Function	Code (Hex)	Code (Dec)	No. of registers
		reg(0)	reg(0)	
3.9.2	ETM_MACRO_CLEAR_SLMT	0x0C13	3091	2
3.10	ETM_SET_ENCODER	0x0A14	2580	5
3.10	ETM_MACRO_SET_ENCODER	0x0C14	3092	5
3.11.1	ETM_SERVO_ON	0x0A15	2581	2
3.11.1	ETM_MACRO_SERVO_ON	0x0C15	3093	2
3.11.2	ETM_SERVO_OFF	0x0A16	2582	2
3.11.2	ETM_MACRO_SERVO_OFF	0x0C16	3094	2
3.12	ETM_SET_ALARM	0x0A17	2583	4
3.12	ETM_MACRO_SET_ALARM	0x0C17	3095	4
3.13	ETM_SET_INPOS	0x0A18	2584	4
3.13	ETM_MACRO_SET_INPOS	0x0C18	3096	4
3.14	ETM_SET_FILTER	0x0A19	2585	4
3.14	ETM_MACRO_SET_FILTER	0x0C19	3097	4
3.15.1	ETM_VRING_ENABLE	0x0A1A	2586	4
3.15.1	ETM_MACRO_VRING_ENABLE	0x0C1A	3098	4
3.15.2	ETM_VRING_DISABLE	0x0A1B	2587	2
3.15.2	ETM_MACRO_VRING_DISABLE	0x0C1B	3099	2
3.16.1	ETM_AVTRI_ENABLE	0x0A1C	2588	2
3.16.1	ETM_MACRO_AVTRI_ENABLE	0x0C1C	3100	2
3.16.2	ETM_AVTRI_DISABLE	0x0A1D	2589	2
3.16.2	ETM_MACRO_AVTRI_DISABLE	0x0C1D	3101	2
3.17.1	ETM_EXD_MP	0x0A1E	2590	4
3.17.2	ETM_EXD_FP	0x0A1F	2591	4
3.17.3	ETM_EXD_CP	0x0A20	2592	4
3.17.4	ETM_EXD_DISABLE	0x0A21	2593	2
3.18.1	ETM_READ_bVAR	xxxxxx	xxxxxx	x
3.18.2	ETM_WRITE_bVAR	0x0A23	2595	3
3.18.3	ETM_READ_VAR	xxxxxx	xxxxxx	x
3.18.4	ETM_WRITE_VAR	0x0A25	2597	5
3.19.1	ETM_READ_MD	xxxxxx	xxxxxx	x
3.19.2	ETM_WRITE_MD	0x0A27	2599	7
4.1.1	ETM_SET_LP	0x0A28	2600	4
4.1.1	ETM_MACRO_SET_LP	0x0C28	3112	4
4.1.2	ETM_GET_LP	xxxxxx	xxxxxx	x
4.1.2	ETM_MACRO_GET_LP	0x0C29	3113	2
4.1.2	ETM_GET_LP_4_AXIS	xxxxxx	xxxxxx	x

Section	Sub_Function	Code (Hex)	Code (Dec)	No. of registers
		reg(0)	reg(0)	
4.2.1	ETM_SET_EP	0x0A2A	2602	4
4.2.1	ETM_MACRO_SET_EP	0x0C2A	3114	4
4.2.2	ETM_GET_EP	xxxxxx	xxxxxx	x
4.2.2	ETM_MACRO_GET_EP	0x0C2B	3115	2
4.2.2	ETM_GET_EP_4_AXIS	xxxxxx	xxxxxx	x
4.3.1	ETM_ABS_SET_POSITION	0x0AF4	2804	4
4.3.1	ETM_MACRO_ABS_SET_POSITION	0x0CF4	3316	4
4.3.2	ETM_ABS_GET_POSITION	xxxxxx	xxxxxx	x
4.3.2	ETM_MACRO_ABS_GET_POSITION	0x0CF5	3317	x
4.3.2	ETM_ABS_GET_POSITION_4_AXIS	xxxxxx	xxxxxx	x
4.4	ETM_GET_CV	xxxxxx	xxxxxx	x
4.4	ETM_GET_CV_4_AXIS	xxxxxx	xxxxxx	x
4.5	ETM_GET_CA	xxxxxx	xxxxxx	x
4.5	ETM_GET_CA_4_AXIS	xxxxxx	xxxxxx	x
4.6.1	ETM_MACRO_GET_DI	0x0C2E	3118	3
4.6.2	ETM_GET_DI_ALL	xxxxxx	xxxxxx	x
4.6.2	ETM_MACRO_GET_DI_ALL	0x0C31	3121	2
4.6.2	ETM_GET_DI_ALL_4_AXIS	xxxxxx	xxxxxx	x
4.7.1	ETM_MACRO_GET_DI_SIGNAL	0x0C40	3136	3
4.7.2	ETM_GET_DI_SIGNAL_ALL	xxxxxx	xxxxxx	x
4.7.2	ETM_MACRO_GET_DI_SIGNAL_ALL	0x0C41	3137	2
4.7.2	ETM_GET_DI_SIGNAL_ALL_4_AXIS	xxxxxx	xxxxxx	x
4.8	ETM_GET_HOME_SEARCH_STATE	xxxxxx	xxxxxx	x
4.8	ETM_MACRO_GET_HOME_SEARCH_STATE	0x0C42	3138	2
4.8	ETM_GET_HOME_SEARCH_STATE_4_AXIS	xxxxxx	xxxxxx	x
4.9.1	ETM_GET_ERROR_STATE	xxxxxx	xxxxxx	x
4.9.1	ETM_MACRO_GET_ERROR	0x0C2F	3119	1
4.9.2	ETM_GET_ERROR_CODE	xxxxxx	xxxxxx	x
4.9.2	ETM_MACRO_GET_ERROR_CODE	0x0C30	3120	2
4.9.2	ETM_GET_ERROR_CODE_4_AXIS	xxxxxx	xxxxxx	x
4.10	ETM_GET_FREE_BUFFER	xxxxxx	xxxxxx	x
4.11	ETM_GET_STOP_STATUS	xxxxxx	xxxxxx	x
4.11	ETM_GET_STOP_STATUS_4_AXIS	xxxxxx	xxxxxx	x
4.12	ETM_GET_EMERGENCY_STATE	xxxxxx	xxxxxx	x

Section	Sub_Function	Code (Hex)	Code (Dec)	No. of registers
		reg(0)	reg(0)	
4.13	ETM_GET_DRIVING_AXIS	XXXXXX	XXXXXX	X
4.14	ETM_GET_INTERPOL_RDY_FLAG	XXXXXX	XXXXXX	X
4.15	ETM_GET_TRIG_INTFACTOR	XXXXXX	XXXXXX	X
4.16.2	ETM_GET_DEVICE_STATE	XXXXXX	XXXXXX	X
5.1.1	ETM_MACRO_FRNET_IN	0x0C32	3122	2
5.1.2	ETM_MACRO_FRNET_READ	0x0C34	3124	5
5.1.3	ETM_FRNET_READ_SINGLE_DIO	XXXXXX	XXXXXX	X
5.1.4	ETM_FRNET_READ_GROUP_DIO	XXXXXX	XXXXXX	X
5.1.5	ETM_FRNET_READ_MULTI_GROUP_DIO	XXXXXX	XXXXXX	X
5.2.1	ETM_MACRO_FRNET_OUT	0x0C33	3123	4
5.2.2	ETM_MACRO_FRNET_WRITE	0x0C35	3125	7
5.2.3	ETM_FRNET_WRITE_SINGLE_DO	XXXXXX	XXXXXX	X
5.2.4	ETM_FRNET_WRITE_GROUP_DO	XXXXXX	XXXXXX	X
5.2.5	ETM_FRNET_WRITE_MULTI_GROUP_D O	XXXXXX	XXXXXX	X
5.3	ETM_MACRO_FRNET_WAIT	0x0C36	3126	7
5.4	ETM_SET_FRNET_TRIGGER_EVENT	XXXXXX	XXXXXX	X
5.5	ETM_GET_FRNET_TRIGGER_EVENT_SE TTING	XXXXXX	XXXXXX	X
6.1	ETM_SET_HV	0x0A3C	2620	4
6.1	ETM_MACRO_SET_HV	0x0C3C	3132	4
6.2	ETM_HOME_LIMIT	0x0A3D	2621	3
6.2	ETM_MACRO_HOME_LIMIT	0x0C3D	3133	3
6.3	ETM_SET_HOME_MODE	0x0A3E	2622	8
6.3	ETM_MACRO_SET_HOME_MODE	0x0C3E	3134	8
6.4	ETM_HOME_START	0x0A3F	2623	2
6.4	ETM_MACRO_HOME_START	0x0C3F	3135	2
7.1.1	ETM_NORMAL_SPEED	0x0A46	2630	3
7.1.1	ETM_MACRO_NORMAL_SPEED	0x0C46	3142	3
7.1.2	ETM_SET_SV	0x0A47	2631	4
7.1.2	ETM_MACRO_SET_SV	0x0C47	3143	4
7.1.3	ETM_SET_V	0x0A48	2632	4
7.1.3	ETM_MACRO_SET_V	0x0C48	3144	4
7.1.4	ETM_SET_A	0x0A49	2633	4
7.1.4	ETM_MACRO_SET_A	0x0C49	3145	4
7.1.5	ETM_SET_D	0x0A4A	2634	4

Section	Sub_Function	Code (Hex)	Code (Dec)	No. of registers
		reg(0)	reg(0)	
7.1.5	ETM_MACRO_SET_D	0x0C4A	3146	4
7.1.6	ETM_SET_K	0x0A4B	2635	4
7.1.6	ETM_MACRO_SET_K	0x0C4B	3147	4
7.1.7	ETM_SET_L	0x0A4C	2636	4
7.1.7	ETM_MACRO_SET_L	0x0C4C	3148	4
7.1.8	ETM_SET_AO	0x0A4D	2637	4
7.1.8	ETM_MACRO_SET_AO	0x0C4D	3149	4
7.1.9	ETM_FIXED_MOVE	0x0A4E	2638	4
7.1.9	ETM_MACRO_FIXED_MOVE	0x0C4E	3150	4
7.1.10	ETM_SET_PULSE	0x0A4F	2639	4
7.1.10	ETM_MACRO_SET_PULSE	0x0C4F	3151	4
7.1.11	ETM_ABS_FIXED_MOVE	0x0AF6	2806	4
7.1.11	ETM_ABS_MACRO_FIXED_MOVE	0x0CF6	3318	4
7.1.12	ETM_CONTINUE_MOVE	0x0A50	2640	4
7.1.12	ETM_MACRO_CONTINUE_MOVE	0x0C50	3152	4
7.2.1	ETM_AXIS_ASSIGN	0x0A5A	2650	4
7.2.1	ETM_MACRO_AXIS_ASSIGN	0x0C5A	3162	4
7.2.2	ETM_VECTOR_SPEED	0x0A5B	2651	2
7.2.2	ETM_MACRO_VECTOR_SPEED	0x0C5B	3163	2
7.2.3	ETM_SET_VSV	0x0A5C	2652	3
7.2.3	ETM_MACRO_SET_VSV	0x0C5C	3164	3
7.2.4	ETM_SET_VV	0x0A5D	2653	3
7.2.4	ETM_MACRO_SET_VV	0x0C5D	3165	3
7.2.5	ETM_SET_VA	0x0A5E	2654	3
7.2.5	ETM_MACRO_SET_VA	0x0C5E	3166	3
7.2.6	ETM_SET_VD	0x0A5F	2655	3
7.2.6	ETM_MACRO_SET_VD	0x0C5F	3167	3
7.2.7	ETM_SET_VK	0x0A60	2656	3
7.2.7	ETM_MACRO_SET_VK	0x0C60	3168	3
7.2.8	ETM_SET_VL	0x0A61	2657	3
7.2.8	ETM_MACRO_SET_VL	0x0C61	3169	3
7.2.9	ETM_SET_VAO	0x0A62	2658	3
7.2.9	ETM_MACRO_SET_VAO	0x0C62	3170	3
7.2.10	ETM_LINE_2D	0x0A63	2659	5
7.2.10	ETM_MACRO_LINE_2D	0x0C63	3171	5
7.2.11	ETM_ABS_LINE_2D	0x0AF7	2807	5

Section	Sub_Function	Code (Hex)	Code (Dec)	No. of registers
		reg(0)	reg(0)	
7.2.11	ETM_ABS_MACRO_LINE_2D	0x0CF7	3319	5
7.2.12	ETM_LINE_3D	0x0A64	2660	7
7.2.12	ETM_MACRO_LINE_3D	0x0C64	3172	7
7.2.13	ETM_ABS_LINE_3D	0x0AF8	2808	7
7.2.13	ETM_ABS_MACRO_LINE_3D	0x0CF8	3320	7
7.2.14	ETM_ARC_CW	0x0A65	2661	9
7.2.14	ETM_MACRO_ARC_CW	0x0C65	3173	9
7.2.15	ETM_ARC_CCW	0x0A67	2663	9
7.2.15	ETM_MACRO_ARC_CCW	0x0C67	3175	9
7.2.16	ETM_ABS_ARC_CW	0x0AF9	2809	9
7.2.16	ETM_ABS_MACRO_ARC_CW	0x0CF9	3321	9
7.2.17	ETM_ABS_ARC_CCW	0x0AFA	2810	9
7.2.17	ETM_ABS_MACRO_ARC_CCW	0x0CFA	3322	9
7.2.18	ETM_CIRCLE_CW	0x0A69	2665	5
7.2.18	ETM_MACRO_CIRCLE_CW	0x0C69	3177	5
7.2.19	ETM_CIRCLE_CCW	0x0A6A	2666	5
7.2.19	ETM_MACRO_CIRCLE_CCW	0x0C6A	3178	5
7.3.1	ETM_SYNC_ACTION	0x0A6E	2670	14
7.3.1	ETM_MACRO_SYNC_ACTION	0x0C6E	3182	14
7.3.2	ETM_CLEAR_SYNC_ACTION	0x0A95	2709	2
7.3.2	ETM_MACRO_CLEAR_SYNC_ACTION	0x0C95	3221	2
7.3.3	ETM_SET_ACTIVATION_FACTORS	0x0A96	2710	4
7.3.3	ETM_MACRO_SET_ACTIVATION_FACTORS	0x0C96	3222	4
7.3.4	ETM_SET_ACTIVATION_AXIS	0x0A97	2711	3
7.3.4	ETM_MACRO_SET_ACTIVATION_AXIS	0x0C97	3223	3
7.3.5	ETM_SET_ACTION	0x0A98	2712	11
7.3.5	ETM_MACRO_SET_ACTION	0x0C98	3224	11
7.3.6	ETM_SET_COMPARE	0x0A70	2672	6
7.3.6	ETM_MACRO_SET_COMPARE	0x0C70	3184	6
7.3.7	ETM_GET_LATCH	xxxxxx	xxxxxx	x
7.3.7	ETM_MACRO_GET_LATCH	0x0C71	3185	2
7.3.7	ETM_GET_LATCH_4_AXIS	xxxxxx	xxxxxx	x
7.3.8	ETM_SET_PRESET	0x0A72	2674	4
7.3.8	ETM_MACRO_SET_PRESET	0x0C72	3186	4
7.3.9	ETM_SET_OUT	0x0A73	2675	4

Section	Sub_Function	Code (Hex)	Code (Dec)	No. of registers
		reg(0)	reg(0)	
7.3.9	ETM_MACRO_SET_OUT	0x0C73	3187	4
7.3.10	ETM_ENABLE_INT	0x0AAA	2730	1
7.3.10	ETM_MACRO_ENABLE_INT	0x0CAA	3242	1
7.3.11	ETM_DISABLE_INT	0x0AAB	2731	1
7.3.11	ETM_MACRO_DISABLE_INT	0x0CAB	3243	1
7.3.12	ETM_INTFACTOR_ENABLE	0x0AAC	2732	4
7.3.12	ETM_MACRO_INTFACTOR_ENABLE	0x0CAC	3244	4
7.3.13	ETM_INTFACTOR_DISABLE	0x0AAD	2733	3
7.3.13	ETM_MACRO_INTFACTOR_DISABLE	0x0CAD	3245	3
7.4.1	ETM_RECTANGLE	0x0A78	2680	20
7.4.1	ETM_MACRO_RECTANGLE	0x0C78	3192	20
7.4.2	ETM_LINE_2D_INITIAL	0x0A7C	2684	9
7.4.2	ETM_MACRO_LINE_2D_INITIAL	0x0C7C	3196	9
7.4.3	ETM_LINE_2D_CONTINUE	0x0A7E	2686	6
7.4.3	ETM_MACRO_LINE_2D_CONTINUE	0x0C7E	3198	6
7.4.4	ETM_ABS_LINE_2D_CONTINUE	0x0AFB	2811	6
7.4.4	ETM_ABS_MACRO_LINE_2D_CONTINUE	0x0CFB	3323	6
7.4.5	ETM_LINE_3D_INITIAL	0x0A7F	2687	10
7.4.5	ETM_MACRO_LINE_3D_INITIAL	0x0C7F	3199	10
7.4.6	ETM_LINE_3D_CONTINUE	0x0A81	2689	8
7.4.6	ETM_MACRO_LINE_3D_CONTINUE	0x0CFC	3324	8
7.4.7	ETM_ABS_LINE_3D_CONTINUE	0x0AFC	2812	8
7.4.7	ETM_ABS_MACRO_LINE_3D_CONTINUE	0x0C81	3201	8
7.4.8	ETM_MIX_2D_INITIAL	0x0A82	2690	10
7.4.8	ETM_MACRO_MIX_2D_INITIAL	0x0C82	3202	10
7.4.9	ETM_MIX_2D_CONTINUE	0x0AFD	2813	11
7.4.9	ETM_MACRO_MIX_2D_CONTINUE	0x0CFD	3325	11
7.4.10	ETM_ABS_MIX_2D_CONTINUE	0x0A84	2692	11
7.4.10	ETM_ABS_MACRO_MIX_2D_CONTINUE	0x0C84	3204	11
7.4.11	ETM_HELIX_3D	0x0A88	2696	15
7.4.11	ETM_MACRO_HELIX_3D	0x0C88	3208	15
7.4.12	ETM_LINE_SCAN	0x0A90	2704	7
7.4.13	ETM_LINE_SCAN_START	0x0A91	2705	5
7.4.14	ETM_GET_LINE_SCAN_DONE	xxxxxx	xxxxxx	x
7.5.1	ETM_DRV_HOLD	0x0AB4	2740	2
7.5.1	ETM_MACRO_DRV_HOLD	0x0CB4	3252	2

Section	Sub_Function	Code (Hex)	Code (Dec)	No. of registers
		reg(0)	reg(0)	
7.5.2	ETM_DRV_START	0x0AB5	2741	2
7.5.2	ETM_MACRO_DRV_START	0x0CB5	3253	2
7.5.3	ETM_STOP_SLOWLY	0x0AB7	2743	2
7.5.3	ETM_MACRO_STOP_SLOWLY	0x0CB7	3255	2
7.5.4	ETM_STOP_SUDDENLY	0x0AB8	2744	2
7.5.4	ETM_MACRO_STOP_SUDDENLY	0x0CB8	3256	2
7.5.5	ETM_VSTOP_SLOWLY	0x0AB9	2745	1
7.5.5	ETM_MACRO_VSTOP_SLOWLY	0x0CB9	3257	1
7.5.6	ETM_VSTOP_SUDDENLY	0x0ABA	2746	1
7.5.6	ETM_MACRO_VSTOP_SUDDENLY	0x0CBA	3258	1
7.5.7	ETM_CLEAR_STOP	0x0ABB	2747	2
7.5.7	ETM_MACRO_CLEAR_STOP	0x0CBB	3259	2
7.5.8	ETM_CLEAR_VSTOP	0x0A09	2569	1
7.5.8	ETM_MACRO_CLEAR_VSTOP	0x0C09	3081	1
7.5.9	ETM_INTP_END	0x0ABC	2748	2
7.5.9	ETM_MACRO_INTP_END	0x0CBC	3260	2
7.5.10	ETM_EMERGENCY_STOP	0x0A04	2564	2
7.5.11	ETM_CLEAR_EMERGENCY_STOP	0x0A05	2565	1
8.1	ETM_LOAD_INITIAL	0x0AC8	2760	1
9.1.1	ETM_MP_CREATE	0x0AC9	2761	2
9.1.2	ETM_MACRO_MP_CLOSE	0x0CCA	3274	1
9.1.3	ETM_MP_CALL	0x0ACB	2763	2
9.1.3	ETM_MACRO_MP_CALL	0x0CCB	3275	2
9.2.1	ETM_MP_ISR_CREATE	0x0ACD	2765	2
9.2.2	ETM_MACRO_MP_ISR_CLOSE	0x0CCE	3278	1
9.2.3	ETM_MP_ISR_CALL	0x0ACF	2767	2
9.3.1	ETM_MACRO_SET_VAR	0x0CD2	3282	5
9.3.2	ETM_MACRO_SET_RVAR	0x0CD3	3283	3
9.4	ETM_MACRO_VAR_CALCULATE	0x0CD4	3284	8
9.5.1	ETM_MACRO_FOR	0x0CD5	3285	3
9.5.2	ETM_MACRO_NEXT	0x0CD6	3286	1
9.5.3	ETM_MACRO_EXIT_FOR	0x0CDE	3294	1
9.6.1	ETM_MACRO_IF	0x0CD7	3287	6
9.6.2	ETM_MACRO_ELSE	0x0CD8	3288	1
9.6.3	ETM_MACRO_END_IF	0x0CD9	3289	1
9.7.1	ETM_MACRO_GOTO	0x0CDF	3295	2

Section	Sub_Function	Code (Hex)	Code (Dec)	No. of registers
		reg(0)	reg(0)	
9.7.2	ETM_MACRO_LABEL	0x0CE1	3297	2
9.8	ETM_MACRO_TIMER	0x0CDA	3290	3
9.9	ETM_STOP_WAIT	0x0ADB	2779	2
9.9	ETM_MACRO_STOP_WAIT	0x0CDB	3291	2
9.10	ETM_MACRO_EXIT_MACRO	0x0CDD	3293	1
9.11	ETM_MP_TERMINATE	0x0AE2	2786	1
9.11	ETM_MACRO_MP_TERMINATE	0x0CE2	3298	1
9.12	ETM_GET_MP_DOWNLOAD_STATUS	xxxxxx	xxxxxx	x
9.13	ETM_CHANGE_VEL_ON_FLY	0x0A43	2627	4
11.1	ETM_GET_ETM8194H_FIRMWARE_VERSION	xxxxxx	xxxxxx	x
11.2	ETM_GET_i8094H_FIRMWARE_VERSION	xxxxxx	xxxxxx	x
11.3	ETM_GET_DLL_VERSION	xxxxxx	xxxxxx	x



## 12.4 MODBUS Coil Table

The coil table can be accessed with the following Modbus functions:

- Read Coils (FC 01)
- Write Single Coil (FC 05)
- Write Multiple Coils (FC 15)

The table addresses defined below is zero-based. For some PLC or HMI, the addresses are shown on their documents as 0xxxx; x is digital number (for example 00001 to 09999). The first '0' represents the table is defined for coils; and the following xxxx is the address of a coil.

Most PLC systems use the one-based system which means the Modbus table starts at address 1. The tables defined in this manual are zero-based addresses, which means the table address starts at zero. Therefore the one-based system needs to use the address 1 to access the table at address 0.

## 12.4.1 FRnet Digital Output

The starting address is 0 (zero-based). Please use FC=05, 15 to write the FRnet DO status:

- (1) FC=05. It can be used to write single point FRnet DO (0~127).
- (2) FC=15. It can be used to write multi-point FRnet DO. These DO do not have to be limited to the same group. For example: the user can choose to write DO points from 5~45 (total 41 points).

**Appendix table 183: FRnet Digital Output (PLC addresses: 00001 to 00128)**

FRnet Digital Output				
Group	Channel	Address (zero-based)	Type	Comment
0	0	0	R/W	
	1	1	R/W	
	2	2	R/W	
	3	3	R/W	
	4	4	R/W	
	5	5	R/W	
	6	6	R/W	
	7	7	R/W	
	8	8	R/W	
	9	9	R/W	
	10	10	R/W	
	11	11	R/W	
	12	12	R/W	
	13	13	R/W	
	14	14	R/W	
	15	15	R/W	
1	0	16	R/W	
	1	17	R/W	
	2	18	R/W	
	3	19	R/W	
	4	20	R/W	
	5	21	R/W	
	6	22	R/W	
	7	23	R/W	

	8	24	R/W	
	9	25	R/W	
	10	26	R/W	
	11	27	R/W	
	12	28	R/W	
	13	29	R/W	
	14	30	R/W	
	15	31	R/W	
2	0	32	R/W	
	1	33	R/W	
	2	34	R/W	
	3	35	R/W	
	4	36	R/W	
	5	37	R/W	
	6	38	R/W	
	7	39	R/W	
	8	40	R/W	
	9	41	R/W	
	10	42	R/W	
	11	43	R/W	
	12	44	R/W	
	13	45	R/W	
	14	46	R/W	
	15	47	R/W	
3	0	48	R/W	
	1	49	R/W	
	2	50	R/W	
	3	51	R/W	
	4	52	R/W	
	5	53	R/W	
	6	54	R/W	
	7	55	R/W	
	8	56	R/W	
	9	57	R/W	
	10	58	R/W	
	11	59	R/W	
	12	60	R/W	

	13	61	R/W	
	14	62	R/W	
	15	63	R/W	
4	0	64	R/W	
	1	65	R/W	
	2	66	R/W	
	3	67	R/W	
	4	68	R/W	
	5	69	R/W	
	6	70	R/W	
	7	71	R/W	
	8	72	R/W	
	9	73	R/W	
	10	74	R/W	
	11	75	R/W	
	12	76	R/W	
	13	77	R/W	
	14	78	R/W	
	15	79	R/W	
5	0	80	R/W	
	1	81	R/W	
	2	82	R/W	
	3	83	R/W	
	4	84	R/W	
	5	85	R/W	
	6	86	R/W	
	7	87	R/W	
	8	88	R/W	
	9	89	R/W	
	10	90	R/W	
	11	91	R/W	
	12	92	R/W	
	13	93	R/W	
	14	94	R/W	
	15	95	R/W	
6	0	96	R/W	
	1	97	R/W	

	2	98	R/W	
	3	99	R/W	
	4	100	R/W	
	5	101	R/W	
	6	102	R/W	
	7	103	R/W	
	8	104	R/W	
	9	105	R/W	
	10	106	R/W	
	11	107	R/W	
	12	108	R/W	
	13	109	R/W	
	14	110	R/W	
	15	111	R/W	
7	0	112	R/W	
	1	113	R/W	
	2	114	R/W	
	3	115	R/W	
	4	116	R/W	
	5	117	R/W	
	6	118	R/W	
	7	119	R/W	
	8	120	R/W	
	9	121	R/W	
	10	122	R/W	
	11	123	R/W	
	12	124	R/W	
	13	125	R/W	
	14	126	R/W	
15	127	R/W		

## 12.4.2 Servo On/Off

Appendix table 194: Servo On/Off (PLC addresses: 00129 to 00132)

Servo State			
Axis	Address (zero based)	Type	Comment
X	128	R	1: Servo on 0: Servo off
Y	129	R	1: Servo on 0: Servo off
Z	130	R	1: Servo on 0: Servo off
U	131	R	1: Servo on 0: Servo off

## 12.5 MODBUS Discrete Input Table

The discrete input table can be accessed by the following Modbus functions:

- Read discrete input (FC 02)

The table addresses defined below is zero-based. For some PLC or HMI, the addresses maybe show on their documents as 1xxxx, x is digital number. For example: 10001 to 19999. The first '1' represents the table is defined for discrete input; and the following xxxx is the address of a discrete input.

In PLC, the first discrete input defined at address 10001 is the same as the first register at address 0 shown in the following table. Most PLC systems which addresses do not start from zero can be referred as one-based system. The following tables will only show zero-based addresses. When PLC or HMI users configure their discrete input numbers, they have to consider discrete input number mapping problem carefully.

## 12.5.1 FRnet Digital Input

Appendix table 25: FRnet Digital Inputs (PLC addresses: 10001 to 10128)

FRnet Digital Input				
Group	Channel	Address (zero based)	Type	Comment
8	0	0	R	
	1	1	R	
	2	2	R	
	3	3	R	
	4	4	R	
	5	5	R	
	6	6	R	
	7	7	R	
	8	8	R	
	9	9	R	
	10	10	R	
	11	11	R	
	12	12	R	
	13	13	R	
	14	14	R	
	15	15	R	
9	0	16	R	
	1	17	R	
	2	18	R	
	3	19	R	
	4	20	R	
	5	21	R	
	6	22	R	
	7	23	R	
	8	24	R	
	9	25	R	
	10	26	R	
	11	27	R	
	12	28	R	



	13	29	R	
	14	30	R	
	15	31	R	
10	0	32	R	
	1	33	R	
	2	34	R	
	3	35	R	
	4	36	R	
	5	37	R	
	6	38	R	
	7	39	R	
	8	40	R	
	9	41	R	
	10	42	R	
	11	43	R	
	12	44	R	
	13	45	R	
	14	46	R	
	15	47	R	
11	0	48	R	
	1	49	R	
	2	50	R	
	3	51	R	
	4	52	R	
	5	53	R	
	6	54	R	
	7	55	R	
	8	56	R	
	9	57	R	
	10	58	R	
	11	59	R	
	12	60	R	
	13	61	R	
	14	62	R	
	15	63	R	

12	0	64	R	
	1	65	R	
	2	66	R	
	3	67	R	
	4	68	R	
	5	69	R	
	6	70	R	
	7	71	R	
	8	72	R	
	9	73	R	
	10	74	R	
	11	75	R	
	12	76	R	
	13	77	R	
	14	78	R	
	15	79	R	
13	0	80	R	
	1	81	R	
	2	82	R	
	3	83	R	
	4	84	R	
	5	85	R	
	6	86	R	
	7	87	R	
	8	88	R	
	9	89	R	
	10	90	R	
	11	91	R	
	12	92	R	
	13	93	R	
	14	94	R	
	15	95	R	
14	0	96	R	
	1	97	R	
	2	98	R	

	3	99	R	
	4	100	R	
	5	101	R	
	6	102	R	
	7	103	R	
	8	104	R	
	9	105	R	
	10	106	R	
	11	107	R	
	12	108	R	
	13	109	R	
	14	110	R	
	15	111	R	
15	0	112	R	
	1	113	R	
	2	114	R	
	3	115	R	
	4	116	R	
	5	117	R	
	6	118	R	
	7	119	R	
	8	120	R	
	9	121	R	
	10	122	R	
	11	123	R	
	12	124	R	
	13	125	R	
	14	126	R	
	15	127	R	

## 12.5.2 DI or Status of Control Board

**Appendix table 26: Motion chip status triggered by DI of Control Board  
(PLC addresses: 10129 to 10192)**

Read DI or Status of Control Board				
Axis	DI	Address (zero based)	Type	Comment
X	DRIVING	128	R	The driving state of AXIS-X: 1: driving, 0: stop
	LIMIT+	129	R	The hardware limit (LMT+) state of AXIS-X: 0: off, 1: on
	LIMIT-	130	R	The hardware limit (LMT-) state of AXIS-X: 0: off, 1: on
	EMERGENCY	131	R	The emergency (EMG) state of AXIS-X: 0: off, 1: on
	ALARM	132	R	The ALARM state of AXIS-X: (please enable Alarm with ETM_SET_ALARM()) 0: off, 1: on
	HOME	133	R	The HOME/IN1 state of AXIS-X: 0: on, 1: off
	NHOME	134	R	The NHOME/IN0 state of AXIS-X: 0: on, 1: off
	IN3	135	R	The IN3 state of AXIS-X: 0: on, 1: off
	INPOS	136	R	The INPOS or Servo Ready state of AXIS-X: 0: on, 1: off
	INDEX	137	R	The Z-phase/IN2 state of AXIS-X: 0: on, 1: off
		138		undefined
		139		
		140		
	141			
	142			
	143			
Y	DRIVING	144	R	The driving state of AXIS-Y: 1: driving, 0: stop
	LIMIT+	145	R	The hardware limit (LMT+) state of AXIS-Y: 0: off, 1: on
	LIMIT-	146	R	The hardware limit (LMT-) state of AXIS-Y: 0: off, 1: on
	EMERGENCY	147	R	The emergency (EMG) state of AXIS-Y: 0: off, 1: on

	ALARM	148	R	The ALARM state of AXIS- Y: (please enable Alarm with ETM_SET_ALARM()) 0: off, 1: on
	HOME	149	R	The HOME/IN1 state of AXIS- Y: 0: on, 1: off
	NHOME	150	R	The NHOME/IN0 state of AXIS- Y: 0: on, 1: off
	IN3	151	R	The IN3 state of AXIS- Y: 0: on, 1: off
	INPOS	152	R	The INPOS or Servo Ready state of AXIS- X: 0: on, 1: off
	INDEX	153	R	The Z-phase/IN2 state of AXIS- Y: 0: on, 1: off
		154		undefined
		155		
		156		
		157		
		158		
		159		
Z	DRIVING	160	R	The driving state of AXIS-Z: 1: driving, 0: stop
	LIMIT+	161	R	The hardware limit (LMT+) state of AXIS-Z: 0: off, 1: on
	LIMIT-	162	R	The hardware limit (LMT-) state of AXIS-Z: 0: off, 1: on
	EMERGENCY	163	R	The emergency (EMG) state of AXIS-Z: 0: off, 1: on
	ALARM	164	R	The ALARM state of AXIS-Z: (please enable Alarm with ETM_SET_ALARM()) 0: off, 1: on
	HOME	165	R	The HOME/IN1 state of AXIS-Z: 0: on, 1: off
	NHOME	166	R	The NHOME/IN0 state of AXIS-Z: 0: on, 1: off
	IN3	167	R	The IN3 state of AXIS-Z: 0: on, 1: off
	INPOS	168	R	The INPOS or Servo Ready state of AXIS- Z: 0: on, 1: off
	INDEX	169	R	The Z-phase/IN2 state of AXIS-Z: 0: on, 1: off
			170	

		171			
		172			
		173			
		174			
		175			
U	DRIVING	176	R	The driving state of AXIS-U: 1: driving, 0: stop	
	LIMIT+	177	R	The hardware limit (LMT+) state of AXIS-U: 0: off, 1: on	
	LIMIT-	178	R	The hardware limit (LMT-) state of AXIS-U: 0: off, 1: on	
	EMERGENCY	179	R	The emergency (EMG) state of AXIS-U: 0: off, 1: on	
	ALARM	180	R	The ALARM state of AXIS-U: (please enable Alarm with ETM_SET_ALARM()) 0: off, 1: on	
	HOME	181	R	The HOME/IN1 state of AXIS-U: 0: on, 1: off	
	NHOME	182	R	The NHOME/IN0 state of AXIS-U: 0: on, 1: off	
	IN3	183	R	The IN3 state of AXIS-U: 0: on, 1: off	
	INPOS	184	R	The INPOS or Servo Ready state of AXIS-U: 0: on, 1: off	
	INDEX	185	R	The Z-phase/IN2 state of AXIS-U: 0: on, 1: off	
			186		undefined
			187		
		188			
		189			
		190			
		191			

### 12.5.3 Error Stop States

Appendix table 27: Error Stop States (PLC addresses: 10193 to 10256)

Read Motion Error States				
Axis	Cause of stop	Modbus Address	Type	Comment
X	SOFT LIMIT+	192	R	Forward <b>software</b> limit of AXIS-X has been encountered
	SOFT LIMIT-	193	R	Reverse <b>software</b> limit of AXIS-X has been encountered
	LIMIT+	194	R	Forward <b>hardware</b> limit of AXIS-X has been encountered
	LIMIT-	195	R	Reverse <b>hardware</b> limit of AXIS-X has been encountered
	ALARM	196	R	The ALARM state of AXIS-X has been activated
	EMERGENCY	197	R	The emergency state of AXIS-X has been activated
	Reserved	198	R	Not defined
	HOME	199	R	Z phase and HOME position of AXIS-X have been reached
	Stop Command	200	R	Motion has been stopped by STOP_SLOWLY STOP_SUDDENLY VSTOP_SLOWLY VSTOP_SUDDENLY
		201		undefined
		202		
		203		
		204		
	205			
	206			
	207			
Y	SOFT LIMIT+	208	R	Forward <b>software</b> limit of AXIS-Y has been encountered
	SOFT LIMIT-	209	R	Reverse <b>software</b> limit of AXIS-Y has been encountered
	LIMIT+	210	R	Forward <b>hardware</b> limit of AXIS-Y has been encountered

	LIMIT-	211	R	Reverse <b>hardware</b> limit of AXIS-Y has been encountered
	ALARM	212	R	The ALARM state of AXIS-Y has been activated
	EMERGENCY	213	R	The emergency state of AXIS-Y has been activated
	Reserved	214	R	Not defined
	HOME	215	R	Z phase and HOME position of AXIS-Y have been reached
	Stop Command	216	R	Motion has been stopped by STOP_SLOWLY STOP_SUDDENLY VSTOP_SLOWLY VSTOP_SUDDENLY
		217		undefined
		218		
		219		
		220		
		221		
		222		
		223		
Z	SOFT LIMIT+	224	R	Forward <b>software</b> limit of AXIS-Z has been encountered
	SOFT LIMIT-	225	R	Reverse <b>software</b> limit of AXIS-Z has been encountered
	LIMIT+	226	R	Forward <b>hardware</b> limit of AXIS-Z has been encountered
	LIMIT-	227	R	Reverse <b>hardware</b> limit of AXIS-Z has been encountered
	ALARM	228	R	The ALARM state of AXIS-Z has been activated
	EMERGENCY	229	R	The emergency state of AXIS-Z has been activated
	Reserved	230	R	Not defined
	HOME	231	R	Z phase and HOME position of AXIS-Z have been reached
	Stop Command	232	R	Motion has been stopped by STOP_SLOWLY STOP_SUDDENLY VSTOP_SLOWLY VSTOP_SUDDENLY



		233		undefined	
		234			
		235			
		236			
		237			
		238			
		239			
U	SOFT LIMIT+	240	R	Forward <b>software</b> limit of AXIS-U has been encountered	
	SOFT LIMIT-	241	R	Reverse <b>software</b> limit of AXIS-U has been encountered	
	LIMIT+	242	R	Forward <b>hardware</b> limit of AXIS-U has been encountered	
	LIMIT-	243	R	Reverse <b>hardware</b> limit of AXIS-U has been encountered	
	ALARM	244	R	The ALARM state of AXIS-U has been activated	
	EMERGENCY	245	R	The emergency state of AXIS-U has been activated	
	Reserved	246	R	Not defined	
	HOME	247	R	Z phase and HOME position of AXIS-U have been reached	
	Stop Command	248	R	Motion has been stopped by STOP_SLOWLY STOP_SUDDENLY VSTOP_SLOWLY VSTOP_SUDDENLY	
			249		undefined
			250		
			251		
			252		
		253			
		254			
		255			

## 12.5.4 DI Signal of Control Board

**Appendix Table 28: DI or Status of Control Board (PLC addresses: 10129 to 10192)**

Read DI or Status of Control Board				
Axis	DI	Address (zero based)	Type	Comment
X	Near Home	256	R	The NHOME/IN0 signal of AXIS-X: 0: on, 1: off
	Home	257	R	The HOME/IN1 signal of AXIS-X: 0: on, 1: off
	Index	258	R	The Index/IN2 signal of AXIS-X: 0: on, 1: off
	IN3	259	R	The IN3 state of AXIS-X: 0: on, 1: off
	MPG (+)	260	R	EXP+ (External input) signal of AXIS-X: 0: off, 1: on (used for driving by external pulses in positive direction)
	MPG (-)	261	R	EXP- (External input) signal of AXIS-X: 0: off, 1: on (used for driving by external pulses in negative direction)
	InPos	262	R	INP signal of AXIS-X: 0: off, 1: on
	Alarm	263	R	The ALARM signal of AXIS-X: 0: off, 1: on
Y	Near Home	264	R	The NHOME/IN0 signal of AXIS-Y: 0: on, 1: off
	Home	265	R	The HOME/IN1 signal of AXIS-Y: 0: on, 1: off
	Index	266	R	The Index/IN2 signal of AXIS-Y: 0: on, 1: off
	IN3	267	R	The IN3 state of AXIS-Y: 0: on, 1: off
	MPG (+)	268	R	EXP+ (External input) signal of AXIS-Y: 0: off, 1: on (used for driving by external pulses in positive direction)
	MPG (-)	269	R	EXP- (External input) signal of AXIS-Y: 0: off, 1: on (used for driving by external pulses in negative direction)
	InPos	270	R	INP signal of AXIS-Y: 0: off, 1: on
	Alarm	271	R	The ALARM signal of AXIS-Y: 0: off, 1: on
Z	Near Home	272	R	The NHOME/IN0 signal of AXIS-Z: 0: on, 1: off

	Home	273	R	The HOME/IN1 signal of AXIS-Z: 0: on, 1: off
	Index	274	R	The Index/IN2 signal of AXIS-Z: 0: on, 1: off
	IN3	275	R	The IN3 state of AXIS-Z: 0: on, 1: off
	MPG (+)	276	R	EXP+ (External input) signal of AXIS-Z: 0: off, 1: on (used for driving by external pulses in positive direction)
	MPG (-)	277	R	EXP- (External input) signal of AXIS-Z: 0: off, 1: on (used for driving by external pulses in negative direction)
	InPos	278	R	INP signal of AXIS-Z: 0: off, 1: on
	Alarm	279	R	The ALARM signal of AXIS-Z: 0: off, 1: on
U	Near Home	380	R	The NHOME/IN0 signal of AXIS-U: 0: on, 1: off
	Home	381	R	The HOME/IN1 signal of AXIS-U: 0: on, 1: off
	Index	382	R	The Index/IN2 signal of AXIS-U: 0: on, 1: off
	IN3	383	R	The IN3 state of AXIS-U: 0: on, 1: off
	MPG (+)	384	R	EXP+ (External input) signal of AXIS-U: 0: off, 1: on (used for driving by external pulses in positive direction)
	MPG (-)	385	R	EXP- (External input) signal of AXIS-U: 0: off, 1: on (used for driving by external pulses in negative direction)
	InPos	386	R	INP signal of AXIS-U: 0: off, 1: on
	Alarm	387	R	The ALARM signal of AXIS-U: 0: off, 1: on

## 13 ET-M8194H LED Description

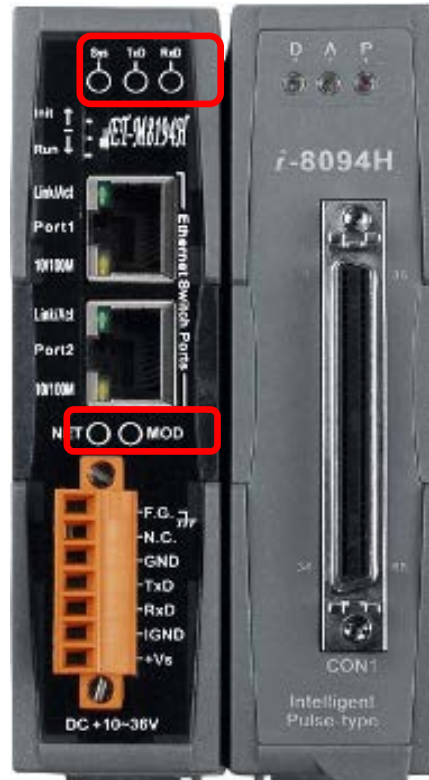

### LED description:

LED	Status	Description
Sys	On	Device is switched on and firmware is running.
	Flashing	Device is switched on and firmware is not running.
	Off	Device is switched off.
Tx	Flashing	Data is transmitted by the ET-M8194H via RS-232.
	Off	No data is sent by the ET-M8194H via RS-232.
Rx	Flashing	The device is receiving data via RS-232.
	Off	No data is being received.
NET	On	Device is connected to Ethernet.
	Flashing	Data is being transmitted via Ethernet.
	Off	Device is not connected to the Ethernet.
MOD	On	Module i-8094H is plugged into ET-M8194H device.
	Flashing	A module different than i-8094H is plugged into ET-M8194H device.
	Off	No module is plugged into the ET-M8194H device.

LED description of the i-8094H module:

- P is the power indicator,
- A is the FRnet indicator, and
- D is the pulse output indicator.

---

# 14 EzMove Utility

---

## 14.1 IP Configuration

### Method 1 – Setting via Ethernet

Step 1: Execute the EzMove Utility and open the “ET-M8194H Setting by Ethernet” window (Setting →By Ethernet ...).

Step 2: Set the DIP-switch to “Init”, then power on the ET-M8194H.



( Dip Switch -- Init )

Step 3: Click “Get Setting”. The utility now reads the Ethernet configuration of the ET-M8194H module set into “Init” mode. Make sure that there is only one ET-M8194H module in “Init” mode connected to the Ethernet.

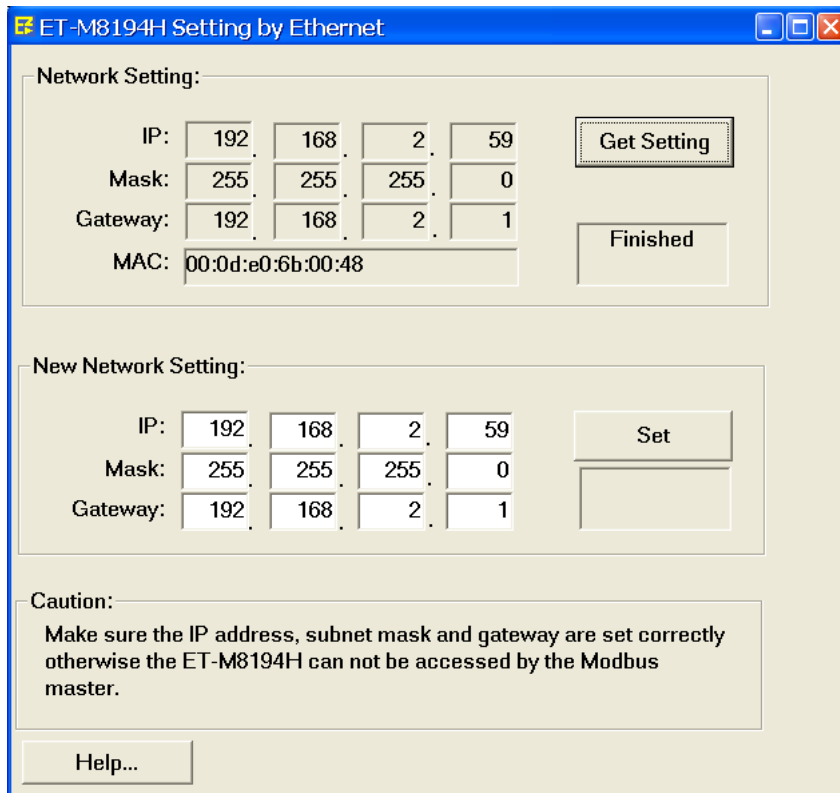

ET-M8194H Setting by Ethernet

Network Setting:

IP:	192	168	2	59
Mask:	255	255	255	0
Gateway:	192	168	2	1
MAC:	00:0d:e0:6b:00:48			

Get Setting

Finished

New Network Setting:

IP:	192	168	2	59
Mask:	255	255	255	0
Gateway:	192	168	2	1

Set

Caution:

Make sure the IP address, subnet mask and gateway are set correctly otherwise the ET-M8194H can not be accessed by the Modbus master.

Help...

Step 4: Enter a new Ethernet setting and click the “Set” button.

Step 5: After the setting is done switch the dip switch back to “Run” and power off/on the module.

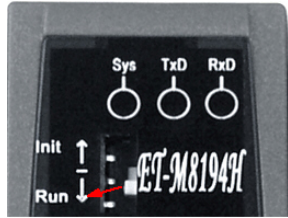

( Dip Switch -- Run )

Now the module is ready to be accessed by using the new Ethernet setting.

## Method 2 – Setting via RS-232

Execute the EzMove Utility and start the “Network Settings By COM Port” dialog. ([Setting] - [ET-M8194H Setting] – [By COM Port] – [Network])

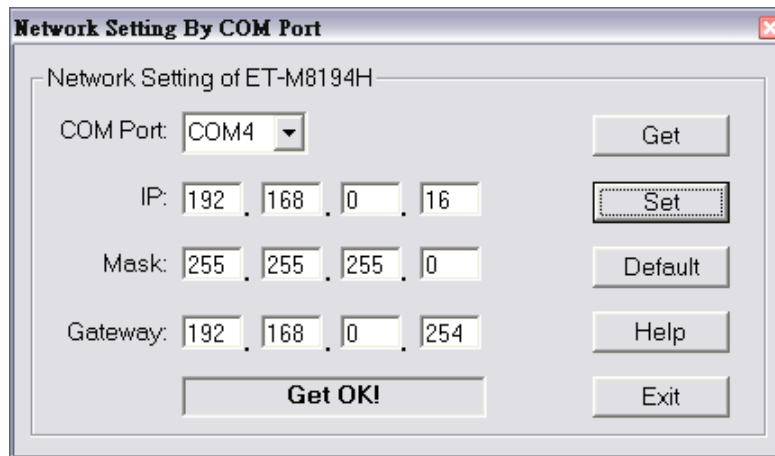

Click **Default** to show the default IP configuration of ET-M8194H:

IP: 192.168.0.16  
Mask: 255.255.255.0  
Gateway: 192.168.0.254

The procedures to read/modify the IP configuration are:

Step 1: Shut down the ET-M8194H.

Step 2: Connect to the ET-M8194H by using the RS-232 cable (CA-0910). The Tx, Rx and GND pins of CA-0910 have to be connected to the Rx, Tx and GND ports of the ET-M8194H. Connect the other end (9-pin, D-sub connector) to the RS232 COM port of your desktop/laptop.

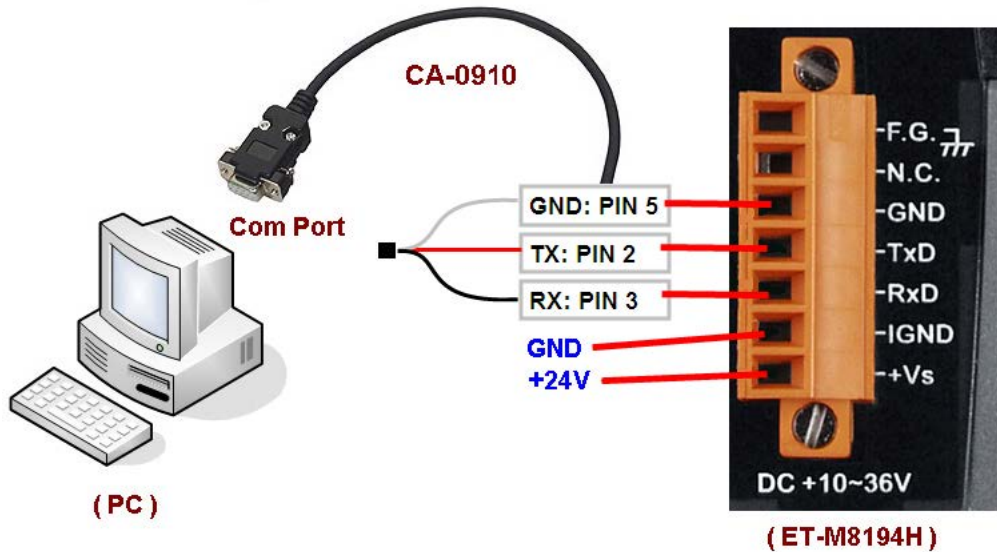

Step 3: Set the DIP-switch to “Init”, then power up the ET-M8194H.



( Dip Switch -- Init )

Step 4: Choose the COM Port of the PC to which the ET-M8194H is connected and then click the **Get** button to read back the IP configuration.

Step 5: Fill the settings in IP, Mask and Gateway fields, and then click the **Set** button to change the IP configuration.

Step 6: Click the **Default** button and then click the **Set** button to restore the default IP configuration.

Step 7: Switch off the ET-M8194H and set the DIP-switch to “Run”.



( Dip Switch -- Run )

Step 8: Again power on the ET-M8194H.

### ATTENTION!!!

Remove the RS-232 cable (CA-0910) from the ET-M8194H after configuration to prevent the device to be affected by noises.



## 14.2 Firmware Update Procedure

Start the *EzMove Utility* and open the “Update Firmware” dialog from the menu-bar: [Setting] – [ET-M8194H Setting] – [By COM Port] – [Update Firmware].

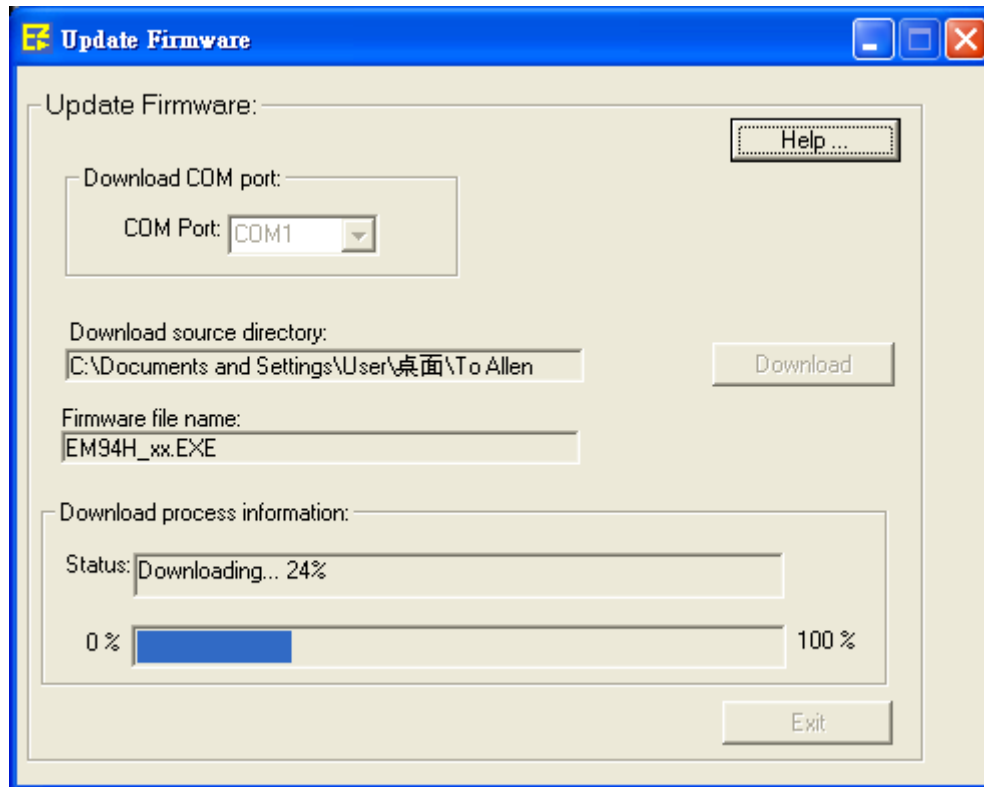

Please follow the following procedures to update firmware:

1. Shut down the ET-M8194H.
2. Connect to ET-M8194H with the associated RS-232 cable (CA-0910). The Tx, Rx and GND pins of CA-0910 are connected to the Rx, Tx and GND ports of ET-M8194H. Please connect the other end (9-pin, D-sub connector) to the normal COM port of desktop/laptop.

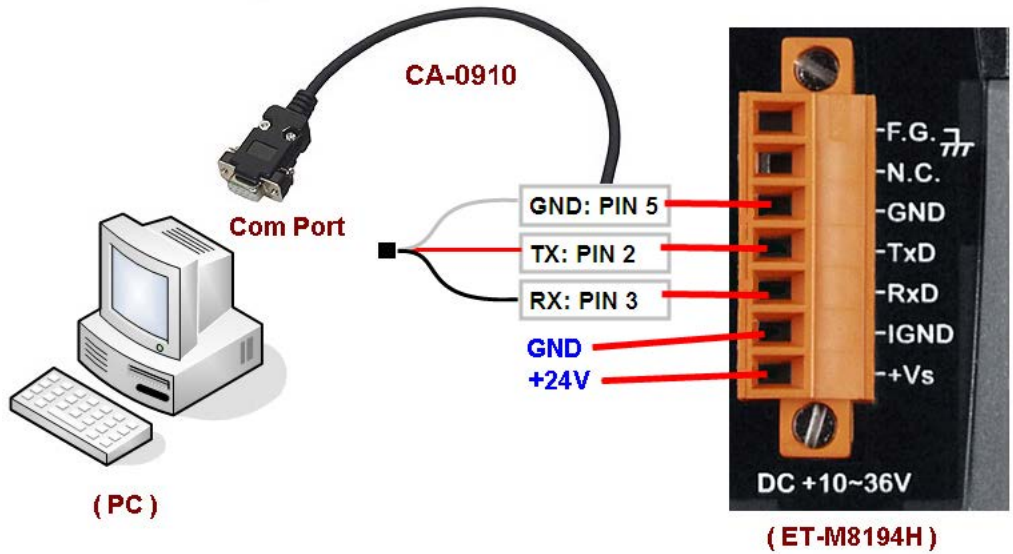

3. Set the DIP-switch to “Init”.



4. Change the setting of JP1 to *disable* read-only function.

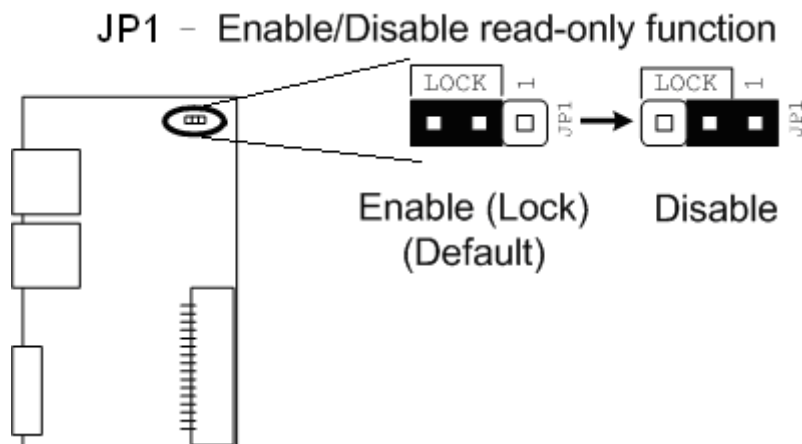

5. Power up the ET-M8194H.

6. Delete the autoexec.bat and EM94H\_XX.EXE in the installed folder of EzMove (ICPDAS\ET\_M8194H\EzMove\_Utility). Copy the new autoexec.bat, ET\_M8194H\_API.dll and the EM94H\_XX.EXE into the same folder.
7. Choose the COM Port that is connected to ET-M8194H (through CA-0903 cable).

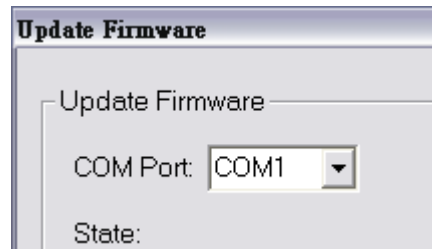

8. Click **Download** button to start firmware-updating procedure.
9. After finishing firmware-updating procedure, shut down the ET-M8194H.
10. Restore the setting of JP1 to *enable* ead-only function.
11. Set the DIP-switch to “Run”.



( Dip Switch -- Run )

12. Power up the ET-M8194H.