

TPM-4100/TP-4100/TP-2070/ TP-3080/TP-5120/TP-6150/ TP-7170 Touch Panel Monitor User Manual



► Warranty

All products manufactured by ICP DAS are under warranty regarding defective materials for a period of one year, beginning from the date of delivery to the original purchaser.

► Warning

ICP DAS assumes no liability for any damage resulting from the use of this product. ICP DAS reserves the right to change this manual at any time without notice. The information furnished by ICP DAS is believed to be accurate and reliable. However, no responsibility is assumed by ICP DAS for its use, nor for any infringements of patents or other rights of third parties resulting from its use.

► Copyright

Copyright © 2012 by ICP DAS Co., Ltd. All rights are reserved.

► Trademarks

Names are used for identification purposes only and may be registered trademarks of their respective companies.

Contact us

If you encounter any problems, please feel free to contact us.

You can rely on ICPDAS for a prompt quick response.

Email: service@icpdas.com

Table of Contents

Table Of Contents

Industrial Communication Products

Table of Contents	3
1. Introduction	6
1.1. Features.....	8
1.2. Specifications.....	9
1.3. Dimension	15
1.4. I/O interfaces.....	29
1.5. Companion CD	31
1.6. System Setup.....	32
1.6.1. System Configuration	32
1.6.2. Panel Mounting.....	37
2. Touch Driver Setup	39
2.1. Windows CE 5.0	40
2.1.1. USB Touch Driver.....	41
2.1.1.1. Installation for WinPAC-8000 and WinPAC-5000	42
2.1.1.2. Configuration for WinPAC-8000 and WinPAC-5000	44
2.1.1.3. Uninstalling the WinPAC-8000 and WinPAC-5000	46
2.1.1.4. Other Windows CE5.0 Devices ...	47
2.1.2. Serial Touch Driver	48
2.1.2.1. Installation for WinPAC-8000 and WinPAC-5000	49
2.1.2.2. Configuration for WinPAC-8000 and WinPAC-5000	52
2.1.2.3. Uninstalling the WinPAC-8000 and WinPAC-5000	54
2.1.2.4. Other Windows CE5.0 Devices ...	55
2.2. Windows CE 6.0	56
2.2.1. USB Touch Driver.....	57
2.2.1.1. Installation for XP-8000-CE6.....	58
2.2.1.2. Configuration for XP-8000-CE6...	60

Table Of Contents

Industrial Communication Products

2.2.1.3. Uninstalling the XP-8000-CE6.....	61
2.2.1.4. Other Windows CE6.0 Devices ...	63
2.2.2. Serial Touch Driver	64
2.2.2.1. Installation for XP-8000-CE6.....	65
2.2.2.2. Configuration for XP-8000-CE6...	68
2.2.2.3. Uninstalling the XP-8000-CE6.....	70
2.2.2.4. Other Windows CE 6.0 Device	72
2.3. Windows CE 7.0	73
2.3.1. USB Touch Driver.....	74
2.3.1.1. Installation for WinPAC-5000-CE775	
2.3.1.2. Configuration for WinPAC-5000-CE7	77
2.3.1.3. Uninstalling the WinPAC-5000-CE779	
2.3.1.4. Other Windows CE7.0 Devices ...	80
2.3.2. Serial Touch Driver	81
2.3.2.1. Installation for WinPAC-5000-CE782	
2.3.2.2. Configuration for WinPAC-5000-CE7	84
2.3.2.3. Uninstalling theWinPAC-5000-CE788	
2.3.2.4. Other Windows CE7.0 Devices ...	89
2.4. Windows XP Embedded	90
2.4.1. Universal Driver	90
2.4.1.1. Installation for XP-8000	91
2.4.1.2. Configuration for XP-8000.....	98
2.4.1.3. Uninstall for XP-8000	102
2.4.1.4. Other Windows XP Embedded Devices	104
2.5. Windows XP/7.....	105
2.5.1. Universal Driver	105
2.5.1.1. Installation	106
2.5.1.2. Configuring.....	111
2.5.1.3. Uninstall	113

Appendix A. Tips 115

- A.1. Don't install USB and serial touch driver simultaneously in a device 115
- A.2. Don't plug USB cable when using serial touch driver 116

Appendix B. Revision History 117

Table Of Contents

Industrial Communication Products

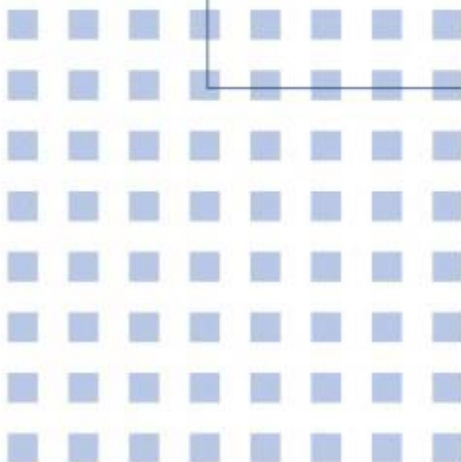
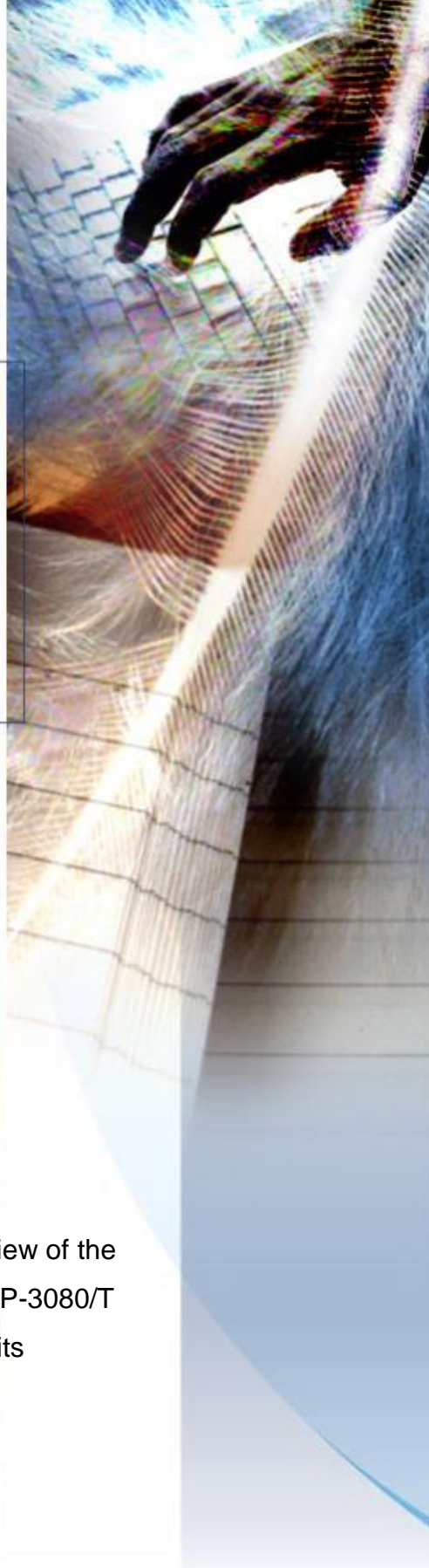

1. Introduction

This chapter provides an overview of the TPM-4100/TP-4100/TP-2070/TP-3080/T P-5120/TP-6150/TP-7170 and its components.

The TPM-4100/TP-4100/TP-2070/TP-3080/TP-5120/TP-6150/TP-7170 Panel Mount Monitor includes a standard TFT LCD screen with a rugged aluminum front bezel resolution and a wide operating temperature range. The TPM-4100/TP-4100/TP-2070/TP-3080/TP-5120/TP-6150/TP-7170 is also guaranteed to integrate with ICP DAS PAC control systems, such as WP-8000 series, LinPAC-8000 series and the XP-8000 series.

Package List

The shipping package includes the following items:

- 1 TFT LCD Monitor
- 1 VGA cable
- 1 RS-232 cable
- 1 USB cable
- 4 Mounting clamps
- 4 Mounting Screws
- 1 Power supply
- 1 Companion CD containing software drivers and digital versions of the user manuals

1.1. Features

- Support resolution

Mode name	Size	Resolution
TP-2070	7"	800 x 480
TP-3080	8.4"	800 x 600
TPM-4100/TP-4100	10.4"	
TP-5120	12.1"	
TP-6150	15"	1024 x 768
TP-7170	17"	1280 x 1024

- Full-function OSD control keys for optimizing the display
- Driver Support for Windows 2K/XP/Vista/7/XP-Embedded/WinCE 5.0/6.0/Linux
- Wide operating temperature range

Mode name	Operating temperature
TP-2070	-20~+70 °C
TP-3080	
TPM-4100/TP-4100	
TP-5120	
TP-6150	
TP-7170	

- Aluminum front bezel design that is ideal for rugged applications
- LED backlight technology
- Supports the IP65 standard for protection against dust and water

1.2. Specifications

The table below is a summary of the specifications of the touch panel, and lists the accessories that are supported by the touch panel.

Specifications

Model	TP-2070
Display	
Size	7"
Resolution	800 x 480
Luminance	400 cd/m ²
Touch screen	4-wire, analog resistive; Light Transmission: 80%
Contrast ratio	500:1
Viewing angle (H/V)	140/120
Backlight life (hrs)	20,000
Touchscreen function	Combo RS-232 & USB interface
Input signal	VGA (analog RGB)
MMI (Man Machine Interface)	
OSD control	Functions: Brightness, Contrast, Clock, Phase, Horizontal Position, Vertical Position and Sharpness
Power switch	Yes
LED indicators	Power, Display signal is detected
Power	
Input range	+12 ~ +48 VDC
Power consumption	5 W
Mechanical	
Casing	Plastic
Dimensions (W x L x H)	213 mm x 148 mm x 44 mm
Installation	Panel Mounting, VESA (75 x 75) Mounting
Ingress protection	Front panel: IP65
Environmental	
Operating temperature	-20 ~ +70°C
Storage temperature	-30 ~ +80°C
Ambient relative humidity	10 ~ 90% RH (non-condensing)

Model	TP-3080
Display	
Size	8.4"
Resolution	800 x 600
Max. Color	16.7 M
Luminance	400 cd/m2
Touch screen	5-wire, analog resistive; Light Transmission: 80%
Contrast ratio	500:1
Viewing angle (H/V)	140/130
Backlight life (hrs)	50,000
Touchscreen function	Combo RS-232 & USB interface
Input signal	VGA (analog RGB)
MMI (Man Machine Interface)	
OSD control	Functions: Brightness, Contrast, Clock, Phase, Horizontal Position, Vertical Position and Sharpness
LED indicators	Power, Display signal is detected
Power	
Input range	+12 ~ +48 Vdc
Power consumption	7 W
Mechanical	
Casing	Plastic
Dimensions (W x L x H)	249 mm x 207 mm x 65 mm
Installation	Panel Mounting, VESA (75 mm x 75 mm; 100 mm x 100 mm) Mounting
Ingress protection	Front panel: IP65
Environmental	
Operating temperature	-20 ~ +70°C
Storage temperature	-30 ~ +80°C
Ambient relative humidity	10 ~ 90% RH (non-condensing)

Model	TPM-4100	TP-4100
Display		
Size	10.4"	
Resolution	800 x 600	
Max. colors	16.7 M	
Luminance	400 cd/m ²	
Touch screen	5-wire, analog resistive Light Transmission: 80%	5-wire, analog resistive Light Transmission: 80%
Contrast ratio	500:1	
Viewing angle (H/V)	140/130	
Backlight life (hrs)	50,000	
Touchscreen function	Combo RS-232 & USB interface	
Input signal	VGA (analog RGB)	
MMI (Man Machine Interface)		
OSD control	Functions: Brightness, Contrast, Clock, Phase, Horizontal Position, Vertical Position and Sharpness	
Power switch	Yes	
LED indicators	Power, Display signal is detected	
Power		
Input range	+12 ~ +48 Vdc	
Power consumption	8.5 W	
Mechanical		
Material	Aluminum	Plastic
Dimensions (W x L x H)	293 mm x 231 mm x 53 mm	291 mm x 229 mm x 54 mm
Installation	Panel Mounting	Panel Mounting, VESA (75 x 75) Mounting
weight	4080g	4050g
Ingress protection	Front panel: IP65	
Environmental		
Operating temperature	-20 ~ +70°C	
Storage temperature	-30 ~ +80°C	
Ambient relative humidity	10 ~ 90% RH (non-condensing)	

Model	TP-5120
Display	
Size	12.1"
Resolution	800 x 600
Max. Color	16.7 M
Luminance	400 cd/m ²
Touch screen	5-wire, analog resistive; Light Transmission: 80%
Contrast ratio	500:1
Viewing angle (H/V)	140/130
Backlight life (hrs)	50,000
Touchscreen function	Combo RS-232 & USB interface
Input signal	VGA (analog RGB)
MMI (Man Machine Interface)	
OSD control	Functions: Brightness, Contrast, Clock, Phase, Horizontal Position, Vertical Position and Sharpness
LED indicators	Power, Display signal is detected
Power	
Input range	+12 ~ +48 Vdc
Power consumption	13 W
Mechanical	
Casing	Plastic
Dimensions (W x L x H)	323 mm x 254 mm x 65 mm
Installation	Panel Mounting, VESA (75 mm x 75 mm; 100 mm x 100 mm) Mounting
Ingress protection	Front panel: IP65
Environmental	
Operating temperature	-20 ~ +70°C
Storage temperature	-30 ~ +80°C
Ambient relative humidity	10 ~ 90% RH (non-condensing)

Model	TP-6150
Display	
Size	15"
Resolution	1024 x 768
Max. colors	16.7 M
Luminance	400 cd/m2
Touch screen	5-wire, analog resistive Light Transmission: 80%
Contrast ratio	500:1
Viewing angle (H/V)	140/130
Backlight life (hrs)	50,000
Touchscreen function	Combo RS-232 & USB interface
Input signal	VGA (analog RGB)
MMI (Man Machine Interface)	
OSD control	Functions: Brightness, Contrast, Phase, Horizontal Position, Vertical Position and sharpness
LED indicators	Power, Display signal is detected
Power	
Input range	+12 ~ +48 VDC
Power consumption	14.4 W
Mechanical	
Material	Plastic
Dimensions (W x L x H)	381 mm x 305 mm x 65 mm
Installation	Panel Mounting, VESA (75mm x 75mm; 100mm x 100mm) Mounting
Ingress protection	Front panel: IP65
Environmental	
Operating temperature	-20 ~ +70°C
Storage temperature	-30 ~ +80°C
Ambient relative humidity	10 ~ 90% RH (non-condensing)

Model	TP-7170
Display	
Size	17"
Resolution	1280 x 1024
Max. colors	16.7 M
Luminance	350 cd/m ²
Touch screen	5-wire, analog resistive Light Transmission: 80%
Contrast ratio	500:1
Viewing angle (H/V)	140/130
Backlight life (hrs)	50,000
Touchscreen function	Combo RS-232 & USB interface
Input signal	VGA (analog RGB)
MMI (Man Machine Interface)	
OSD control	Functions: Brightness, Contrast, Phase, Horizontal Position, Vertical Position and sharpness
LED indicators	Power, Display signal is detected
Power	
Input range	+12 ~ +48 Vdc
Power consumption	22 W
Mechanical	
Material	Plastic
Dimensions (W x L x H)	413 mm x 359 mm x 70 mm
Installation	Panel Mounting, VESA (75mm x 75mm; 100mm x 100mm) Mounting
Ingress protection	Front panel: IP65
Environmental	
Operating temperature	-20 ~ +70°C
Storage temperature	-30 ~ +80°C
Ambient relative humidity	10 ~ 90% RH (non-condensing)

1.3. Dimension

TP-2070 (Unit: mm)

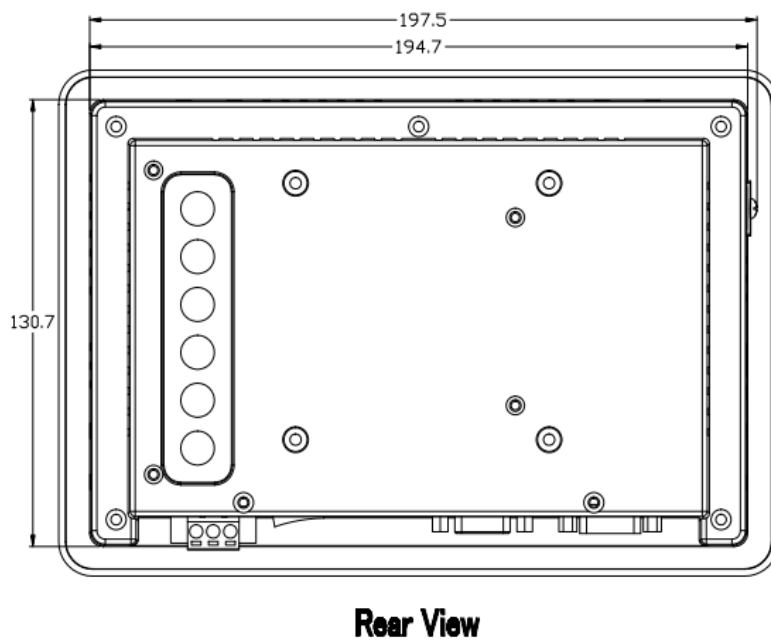
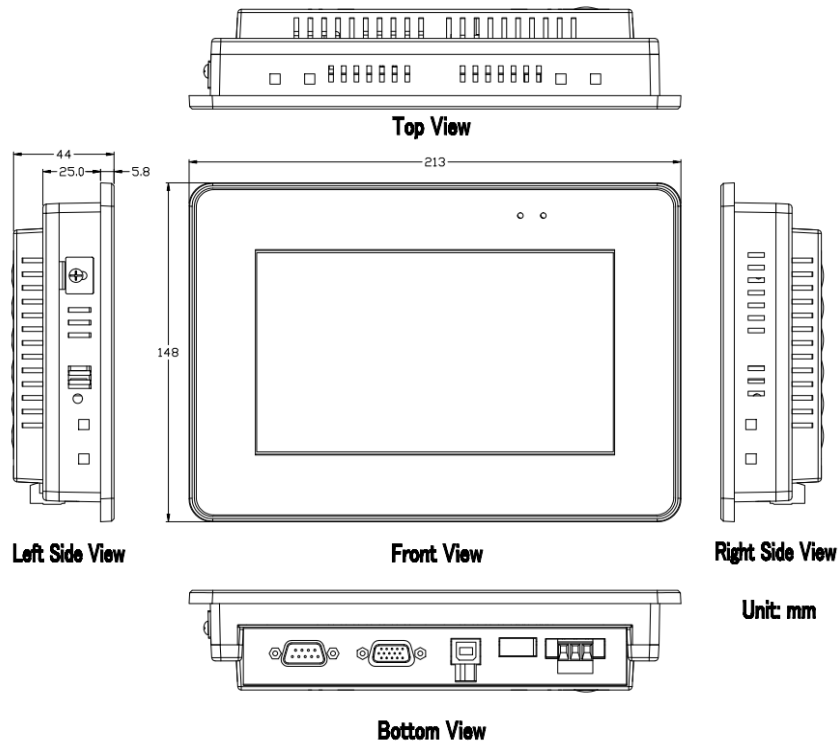

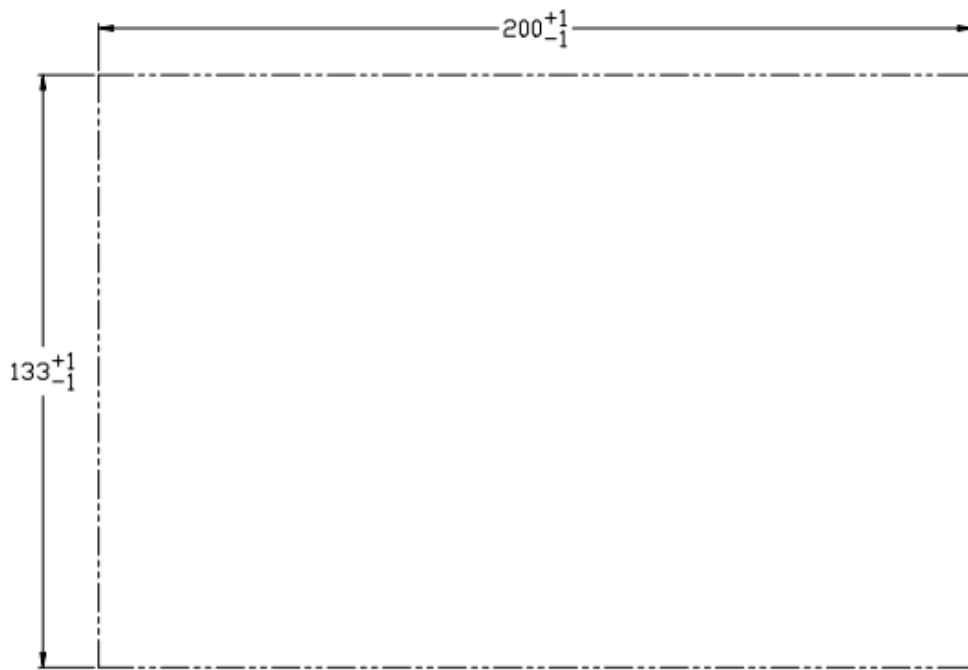

Recommended Panel Cut-Out

TP-3080 (Unit: mm)

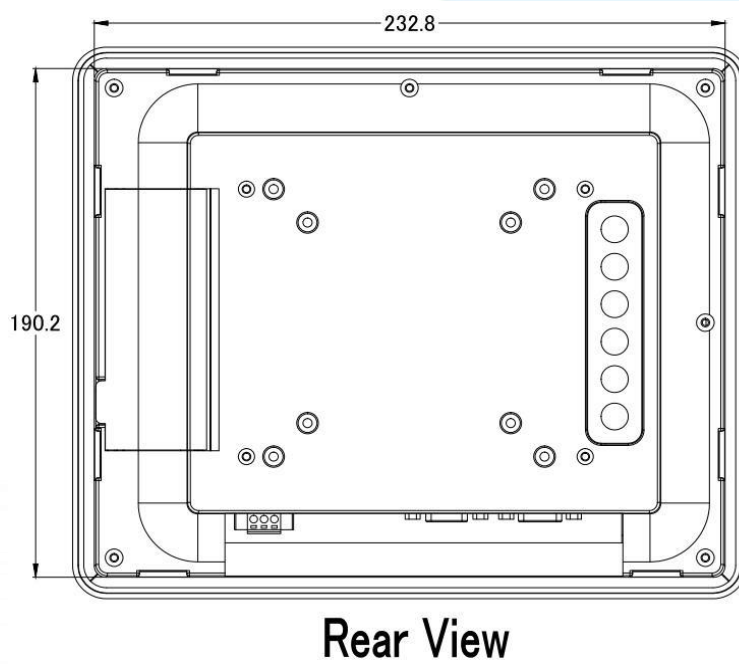
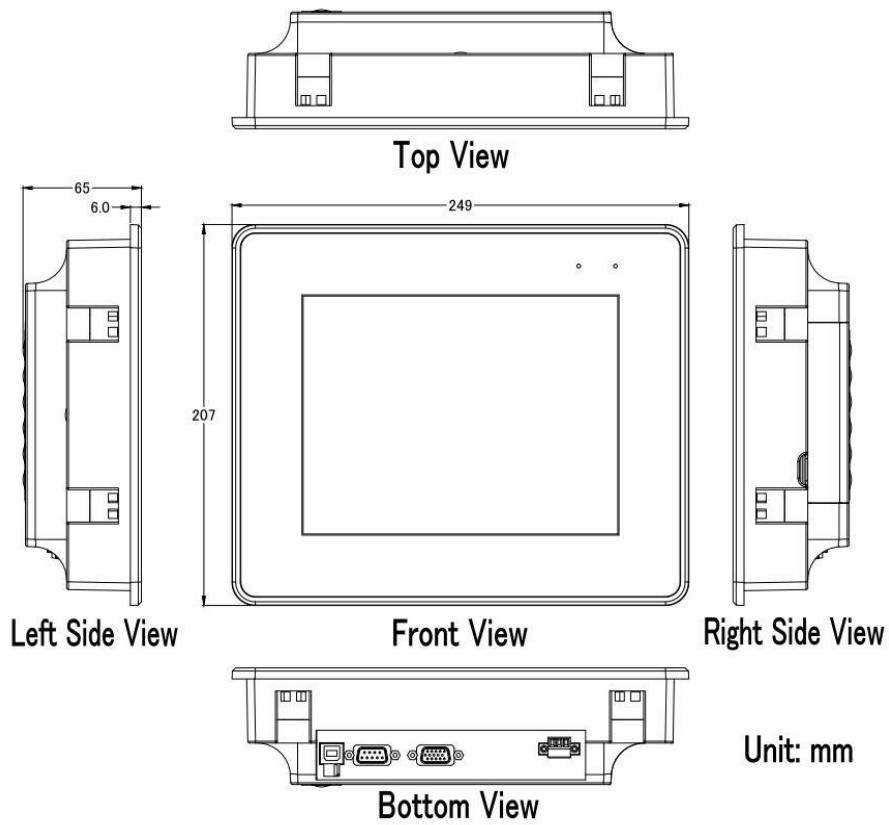

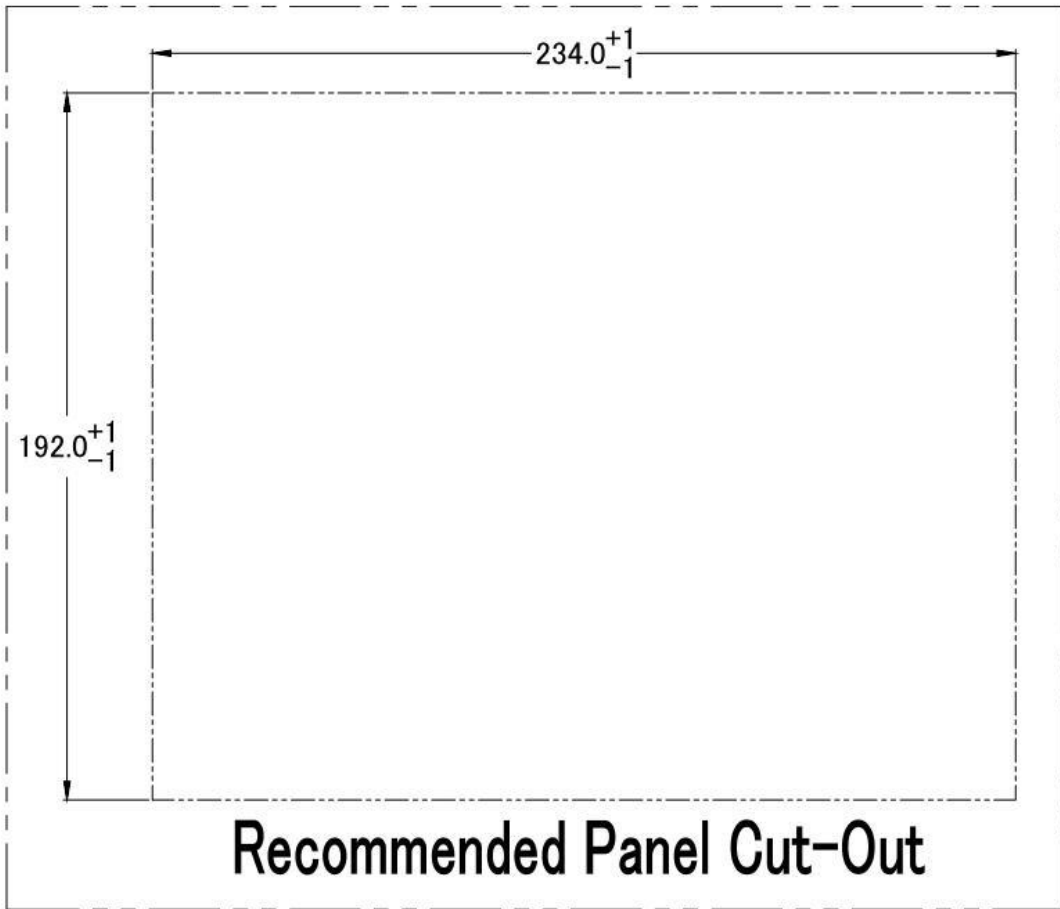

TP-5120 (Unit: mm)

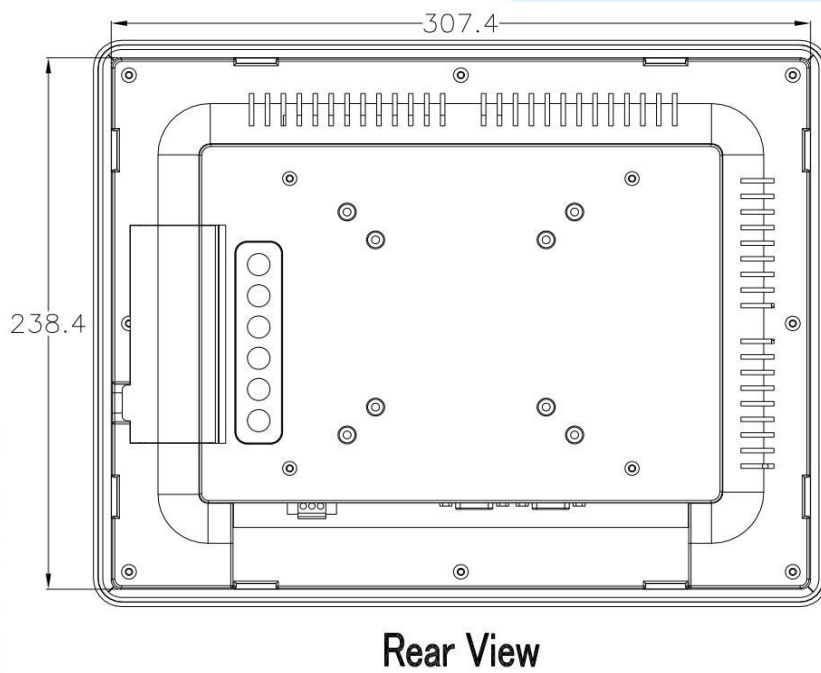
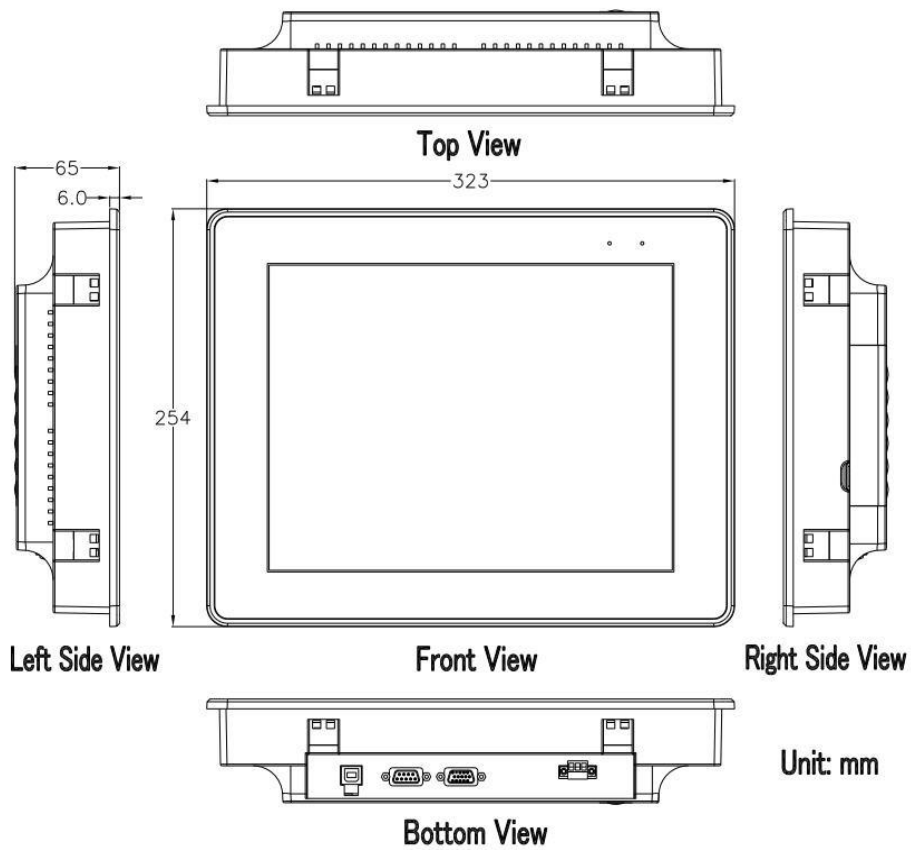

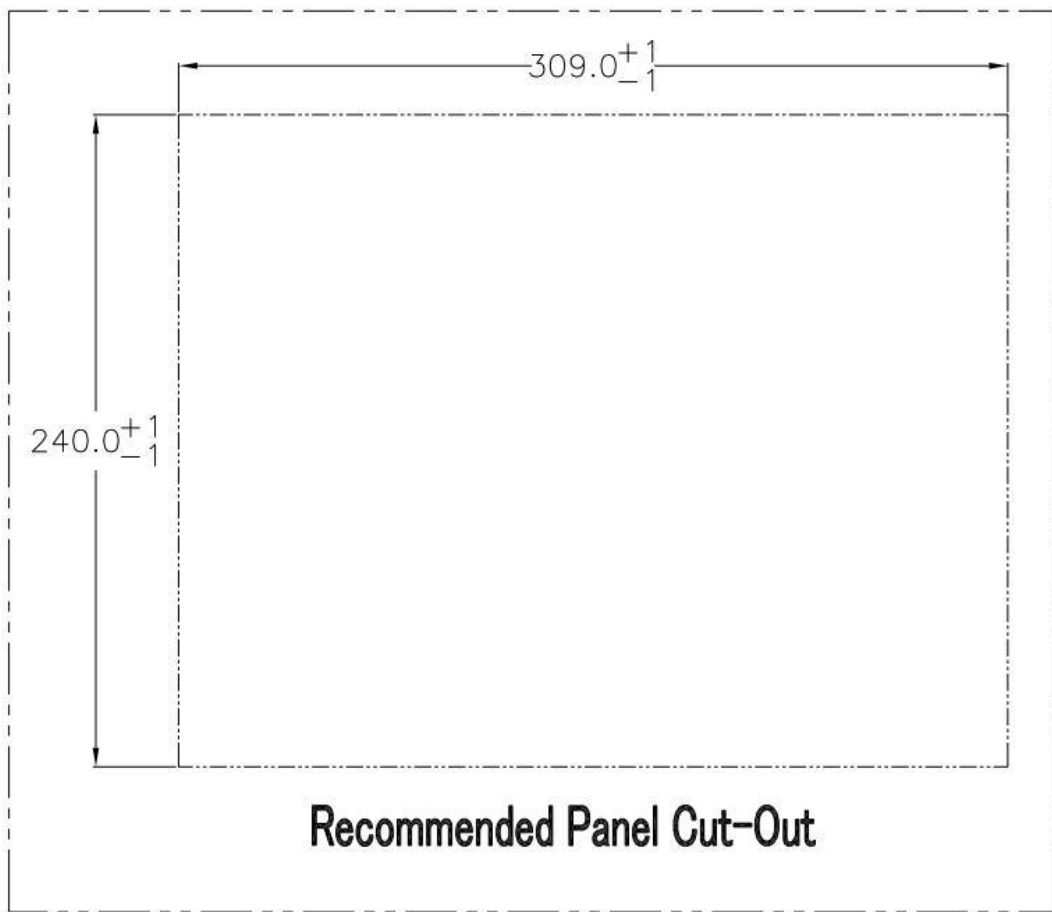

TPM-4100 (Unit: mm)

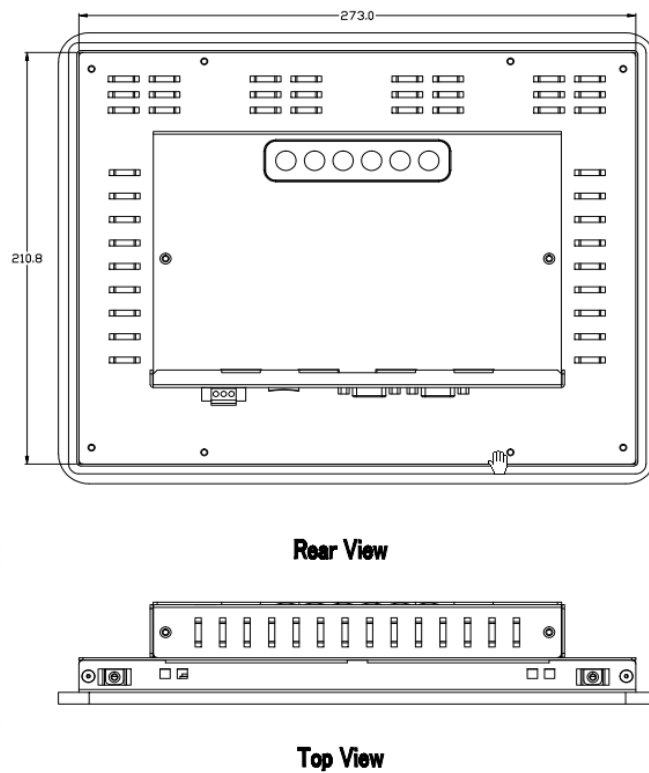
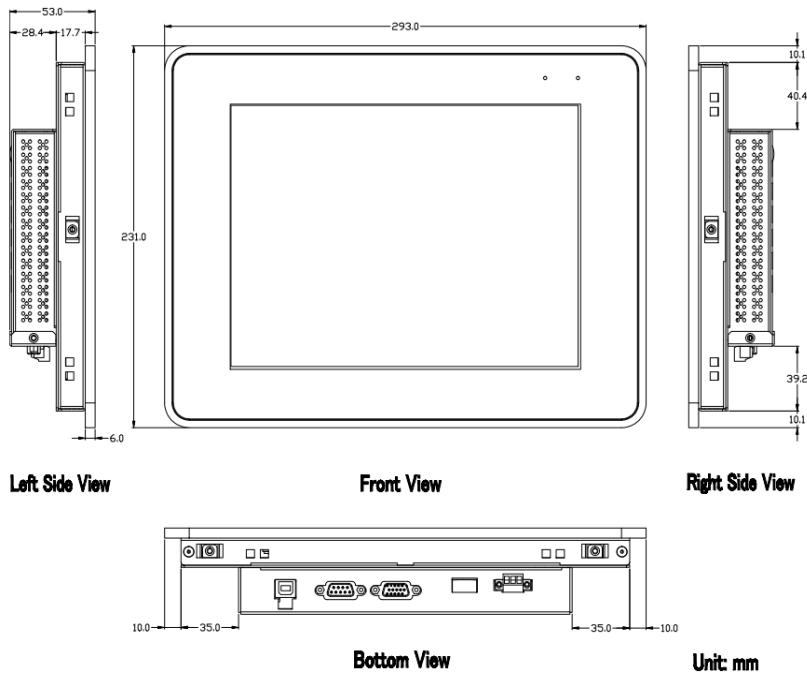

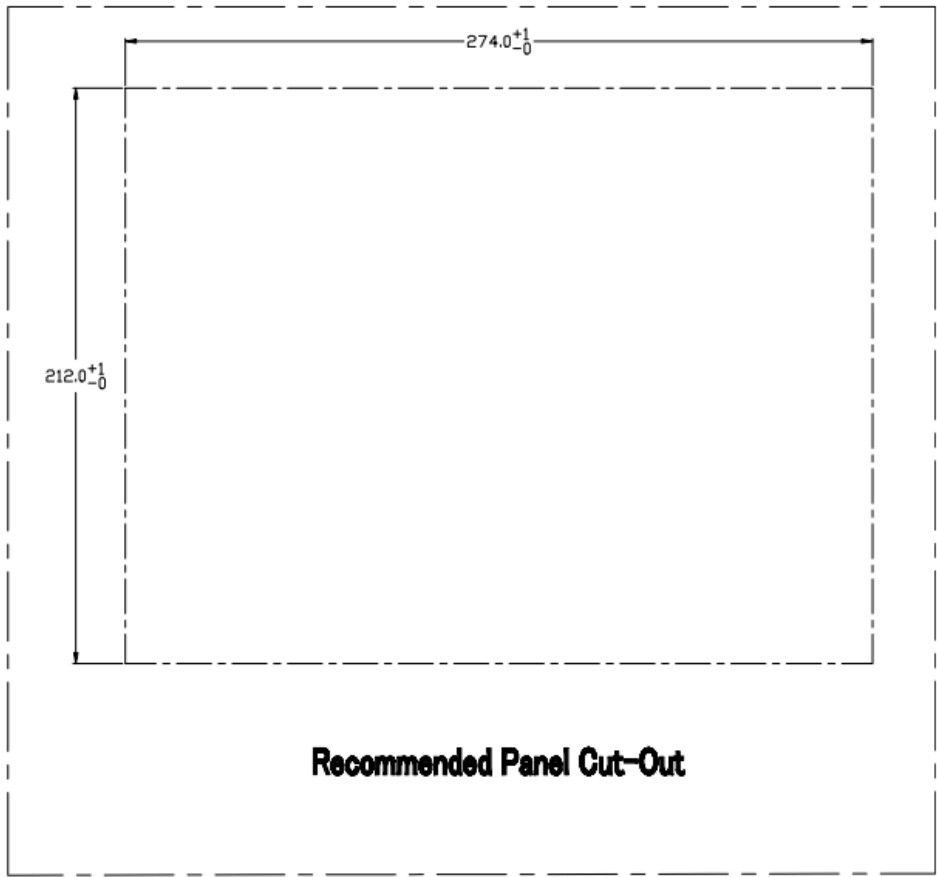

Recommended Panel Cut-Out

TP-4100 (Unit: mm)

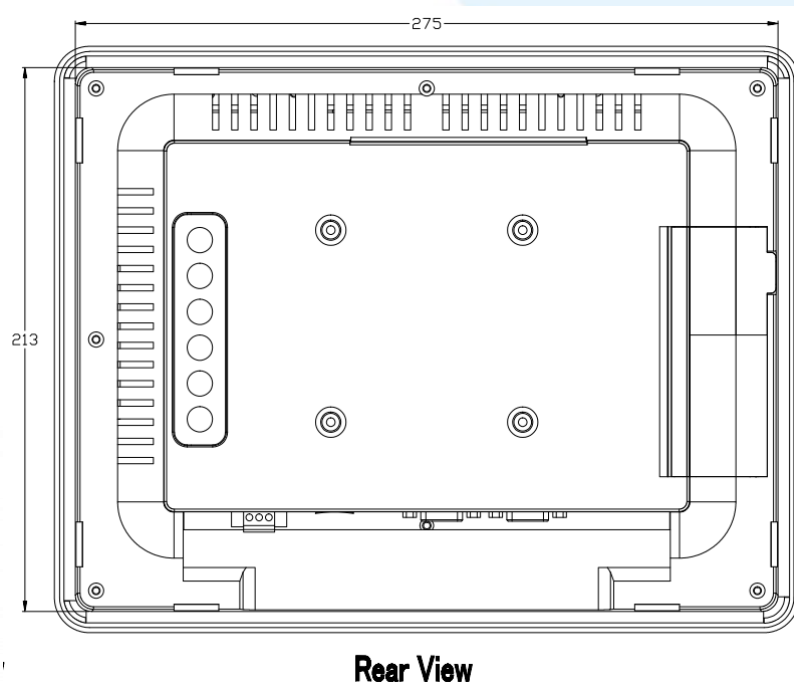
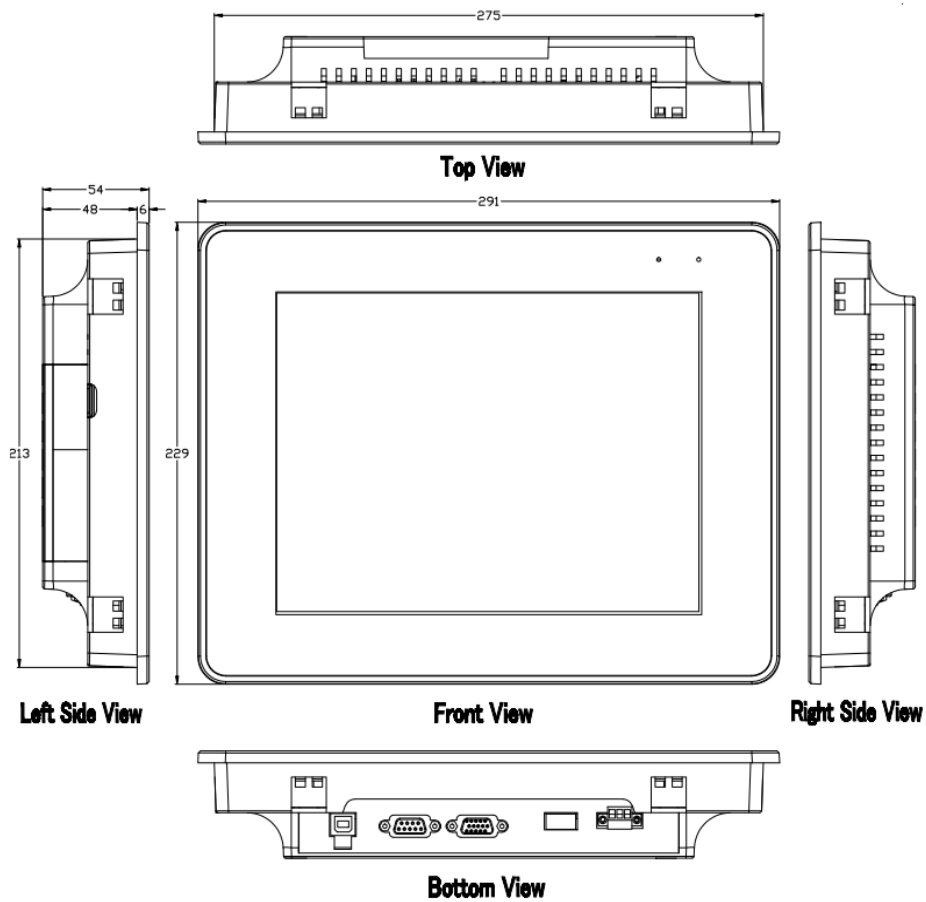

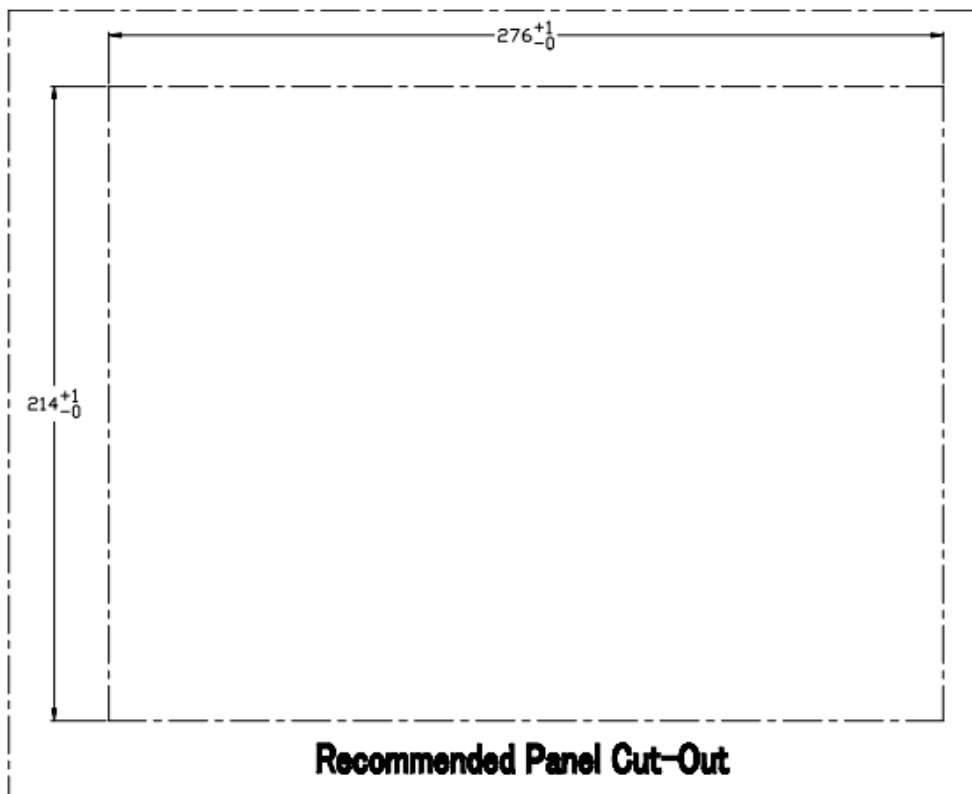

TP-6150 (Unit: mm)

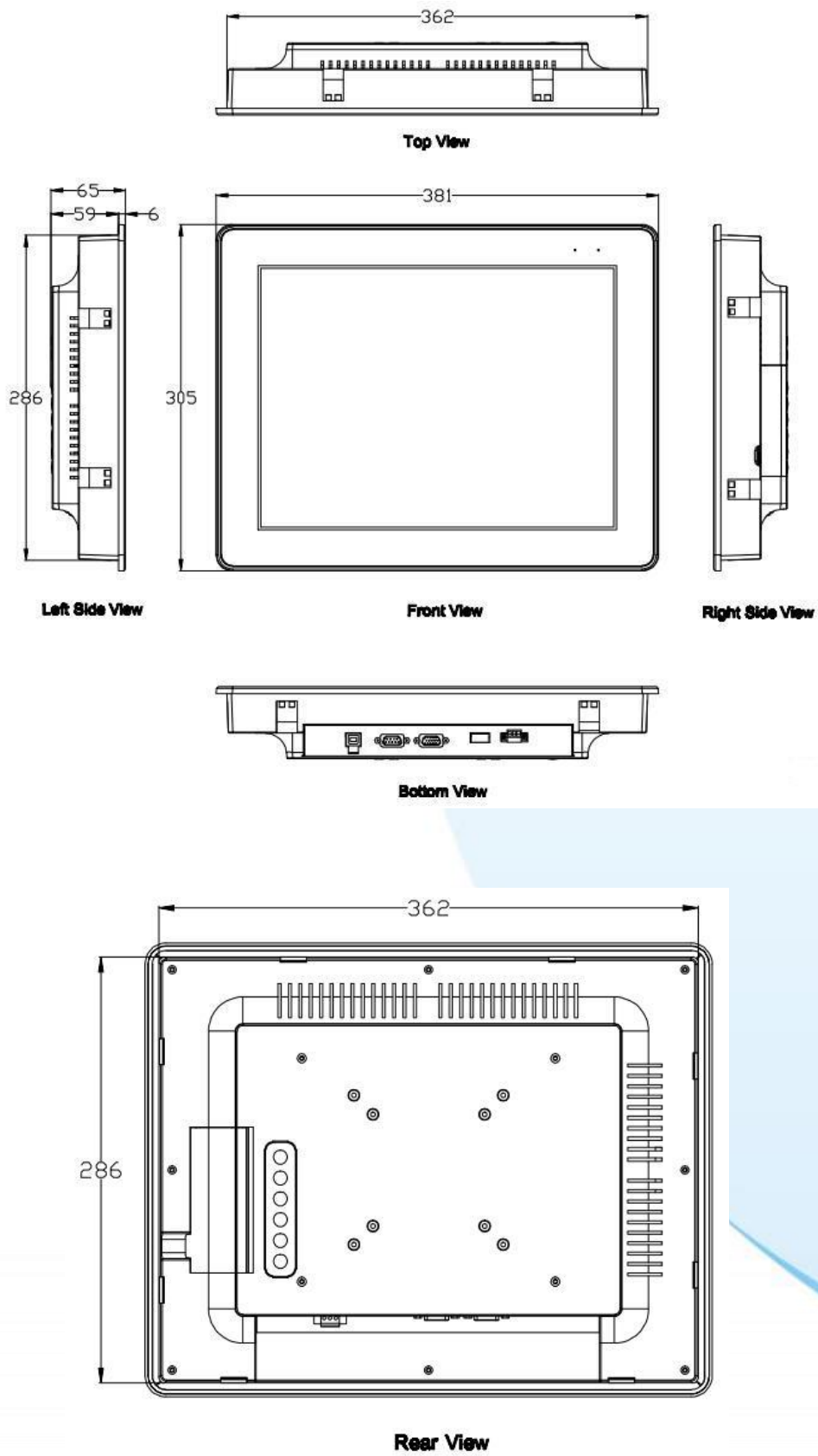

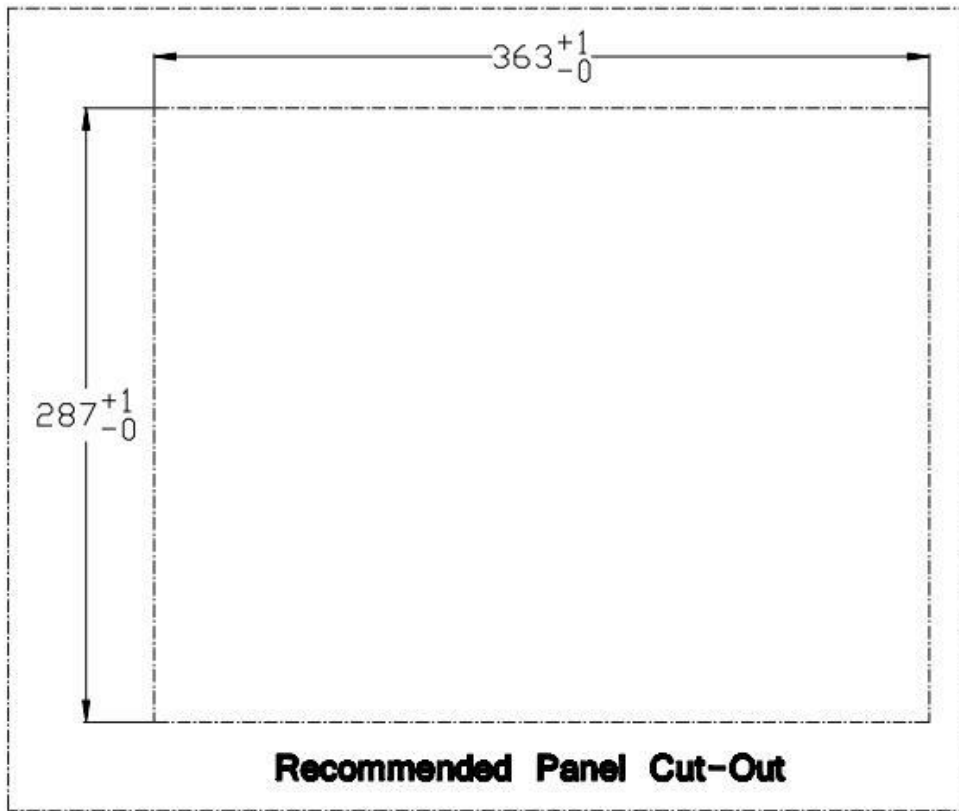

TP-7170 (Unit: mm)

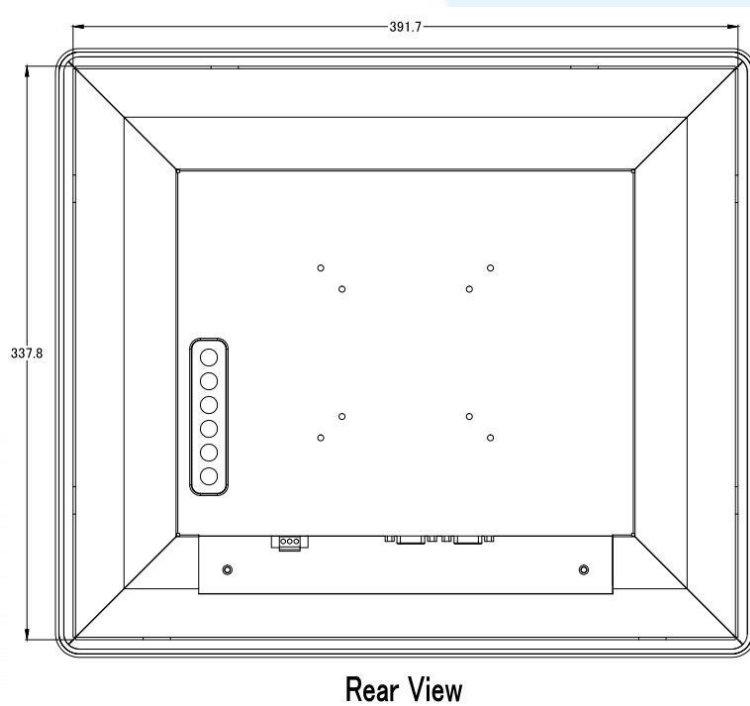
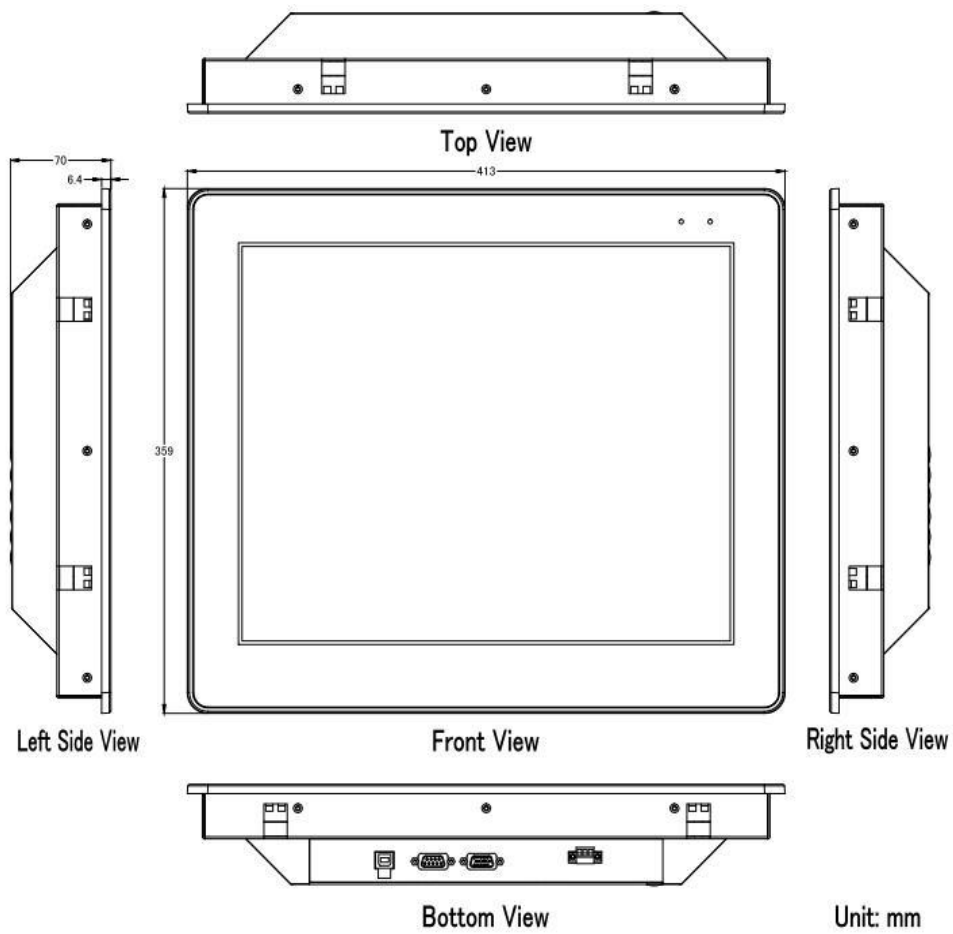

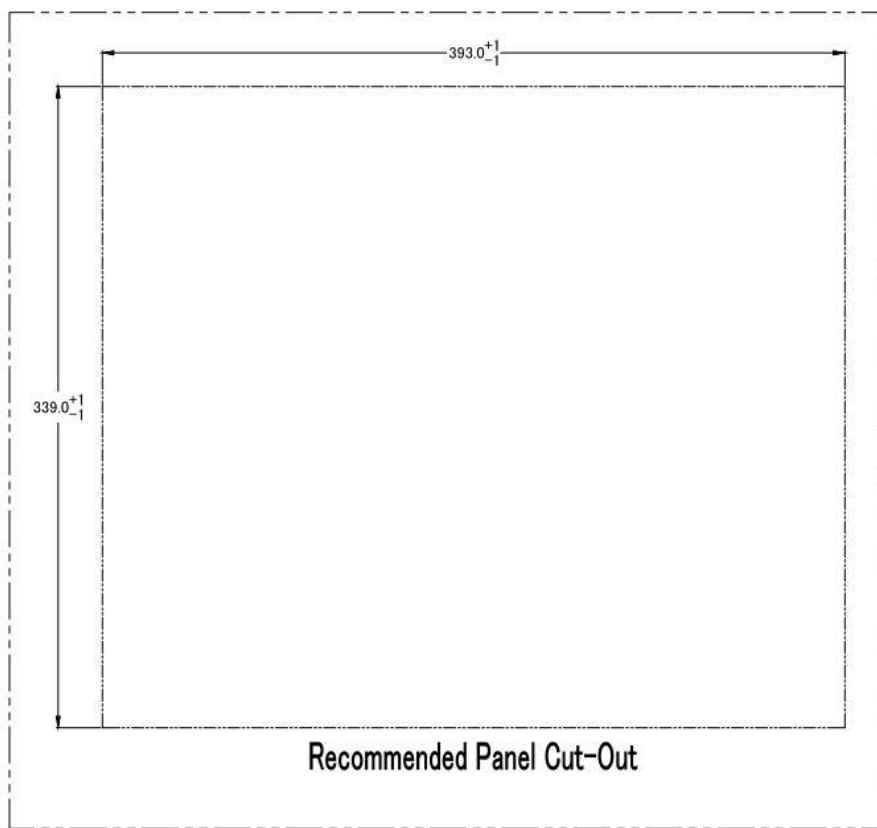

1.4. I/O interfaces

TP-2070

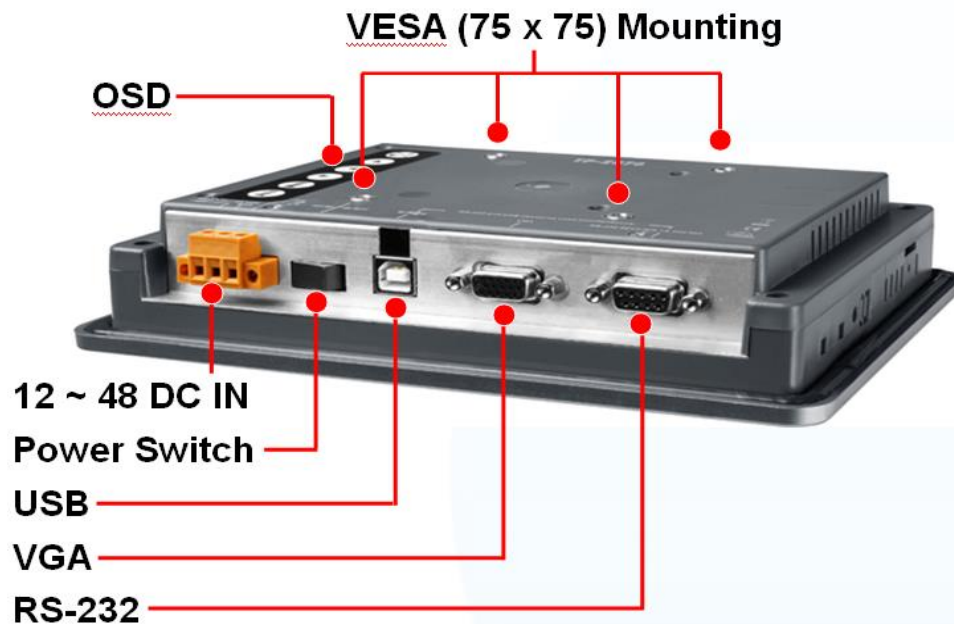

TP-3080/TP-5120/TP-6150/TP-7170

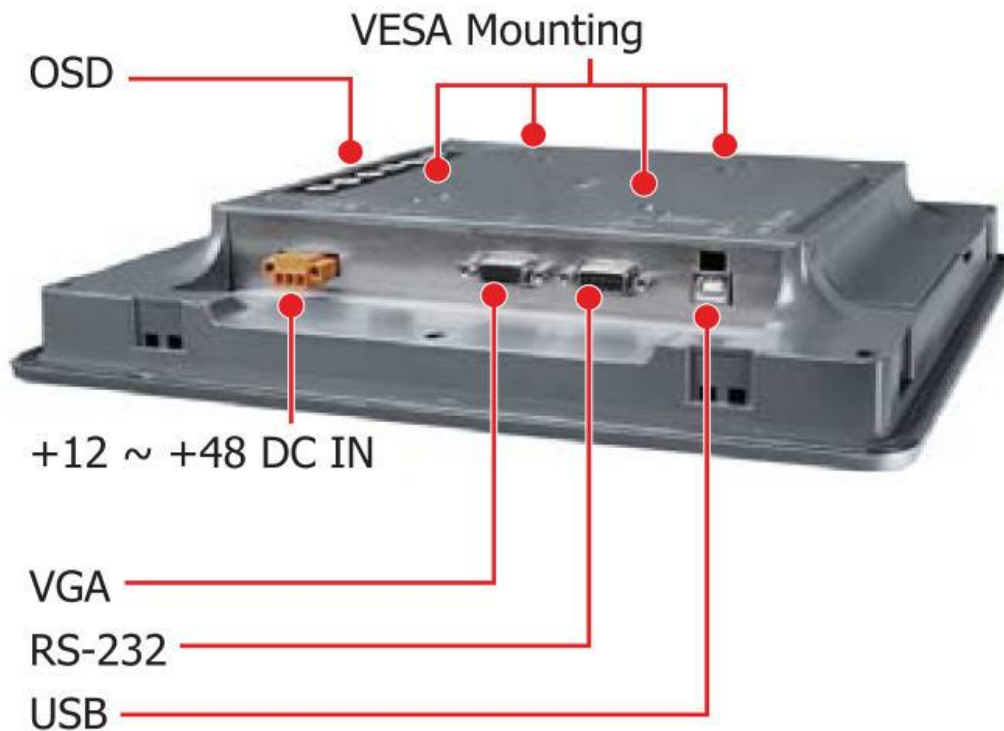

TPM-4100

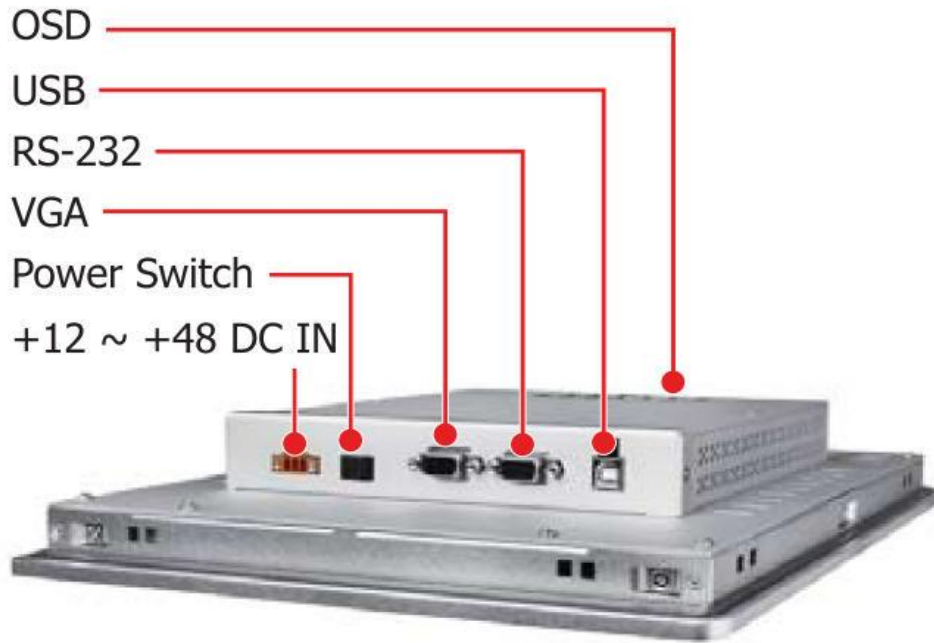

TP-4100

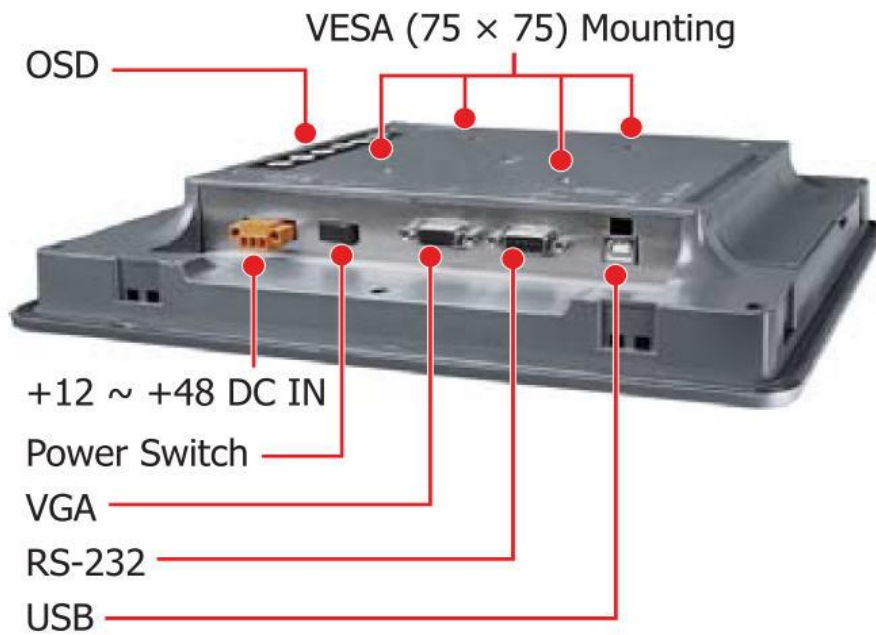

1.5. Companion CD

This package includes a companion CD that contains a collection of documentation and device drivers. An outline of the folder structure is illustrated below.

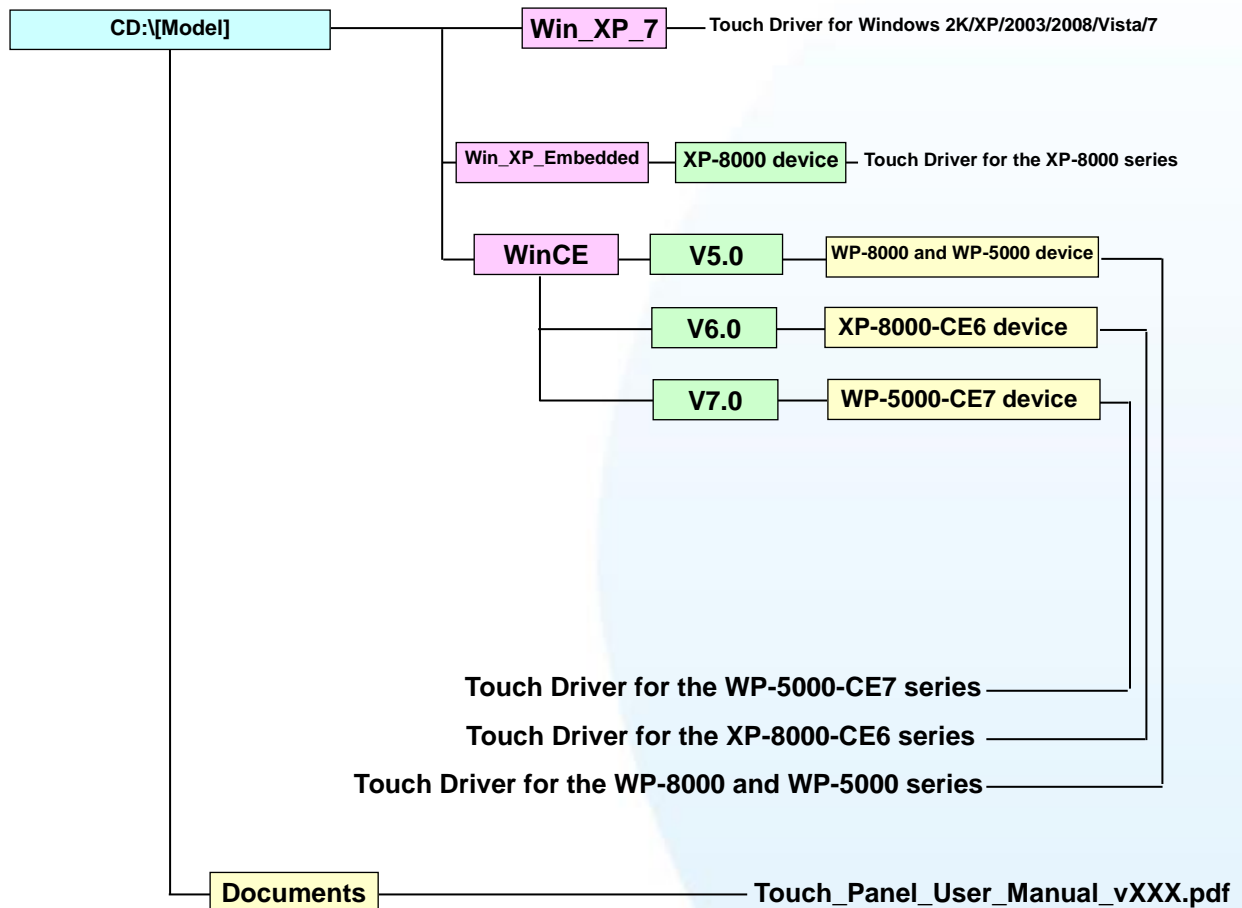

The “[Model]” of the “CD:[Model]” represents TPM-4100_TP-4100, TP-2070, TP-6150, etc. For example, CD:\ TPM-4100_TP-4100, or CD:\ TP-2070.



1.6. System Setup

This section gives details regarding system configuration and adjustment and mounting options.

1.6.1. System Configuration

There are two kinds of OSD menu in the following description.

TP-2070/TP-4100/TPM-4100 support the following OSD menu.



Control	Function
1	Adjust V-Position, H-Position, Clock and Clock and Clock-Phase
2	Turns OSD main menu on or off
3	Selects adjustment item
4	Selects adjustment item counter-clockwise
5	Decreases the value of the adjustment item
6	1. Increases the value of the adjustment item 2. Enter the adjustment item

OSD Menu Functions



Control	Description
Contrast	Adjusts the contrast of the monitor
Brightness	Adjusts the brightness of the monitor
Image setting	Auto config Press to adjust automatically
	Phase Increase or decrease phase value.
	Clock Increase or decrease pixel clock value



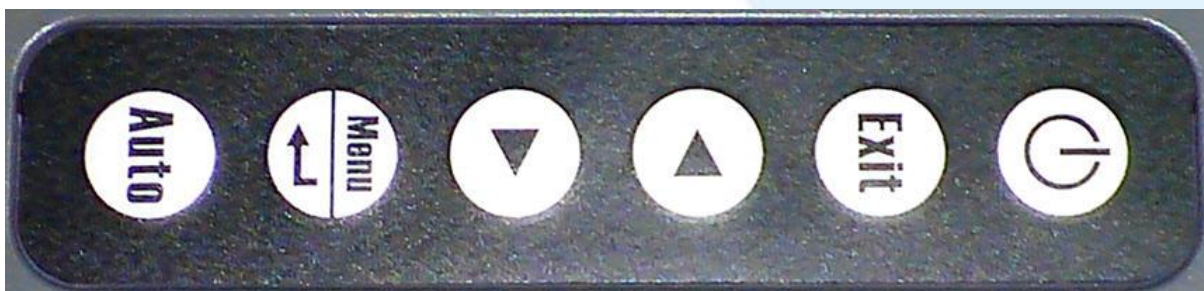

Color setting	H-position	Move the screen left or right
	V-position	Moves the screen up or down
	NATIVE	Color temperature
	9300K	Color temperature
	6500K	Color temperature
OSD setting	USER	Making adjustments to the R/G/B content.
	Language	Support 8 languages.
	OSD.H	Move the OSD position horizontally on the screen. When the ▲ button is pressed, the OSD control menu will move to the right side of the screen. Likewise, when the ▼ button is pressed, the OSD control menu will move to the left side.
	OSD.V	Move the OSD position vertically on the screen. When the ▲ button is pressed, the OSD control menu will move to the top side of the screen. Likewise, when the ▼ button is pressed, the OSD control menu will move to the lower side.

TP-3080/TP-5120/TP-6150/TP-7170 support the following OSD menu.



Control	Function
---------	----------

- | | |
|---|---|
| 1 |  Turn on/Turn off the power. |
| 2 |  OSD exit. |

- 3  Shift the icon to the left side or shift it down.
- 4  Shift the icon to the right side or shift it up.
- 5 
 1. Enter the OSD menu.
 2. Enter the adjustment item.
- 6  Executing auto adjustment.

RUN (Data) and PWR (Power) LED

The RUN (Data) LED and PWR(Power) LED are situated in the top right-hand corner.

The “Data” and “Power” characters are used at the initial stage.



Now the characters are changed. See the following picture.

“Data” to “RUN”. “Power” to “PWR”.



RUN (Data) LED: When the LED is green, it indicates that there is no display signal.

PWR (Power) LED: When the LED is red, it indicates that the power is on. When the LED is not illuminated, it indicates that either the power is off, or the power supply is not connected.

Display Modes

The following display modes are supported for WP-8000 and XP-8000 series.

Platform	Supported Resolution	Supported Vert. Sync.(Hz)
WP-8x4x	800 x 600	55.8/56.6 TP-6150: 55.8
	640 x 480	Don't care TP-2070: Supported by the WP-8x4x OS version 1710 and upward.
WP-8x3x	1024 x 768	60/70/75 TP-6150: 60/75
	800 x 600	60/72/75 TP-6150: 60/72
	640 x 480	56/60/62/70/72/75 TP-6150: 72
WP-5x4x	800 x 600	55.8/56.6
	640 x 480	Don't care TP-2070: Supported by the WP-5x4x OS version 1300 and upward.
XP-8x4x-Atom	1280 x 720	Don't care
	1024 x 768	Don't care
	800 x 600	Don't care
XP-8x4x-Atom-CE6	1024 x 768	60/70/75/85
	800 x 600	60/70/75/85
	640 x 480	60/70/75/85
XP-8x4x	1024 x 768	Don't care
	800 x 600	Don't care
XP-8x4x-CE6	1290 x 1024	TP-2070: not support
		TP-4100/TPM-4100: 60/70/75
	1152 x 864	TP-2070: 70/75
		TP-4100/TPM-4100: 60/70/75
1024 x 768	60/70/75	

	800 x 600	60/70/75
	640 x 480	60/70/75

The following display modes are supported for other devices.

Resolution	Horiz. Sync.	Vert. Sync.
640 x 480	31.4 KHz	50 Hz
	31.4 KHz	59.9 Hz
	37.5 KHz	75 Hz
720 x 400	31.4 KHz	70 Hz
800 x 600	35.1 KHz	56.2 Hz
	37.8 KHz	60.3 Hz
	46.9 KHz	75 Hz
1024 x 768	48.3 KHz	60 Hz
	56.4 KHz	70 Hz
	60.0 KHz	75 Hz

1.6.2. Panel Mounting

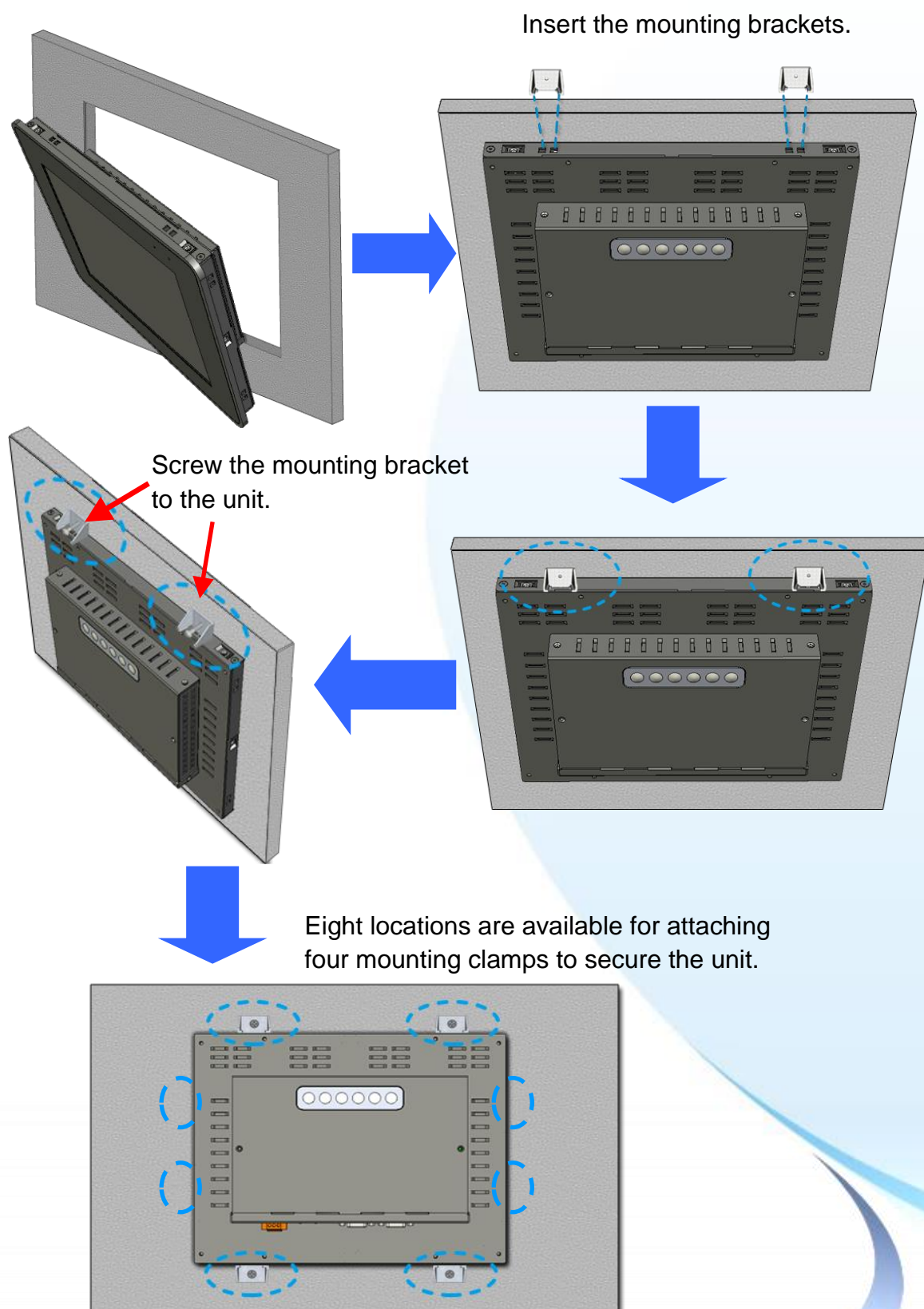

Panel thickness up to 6 mm.

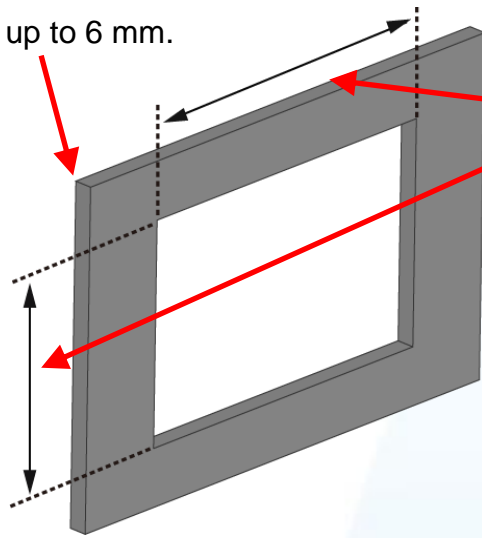

Refer to Sec.1.3 for default information regarding the dimensions of the panel.

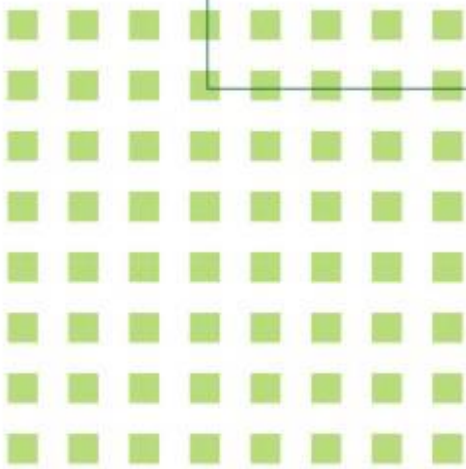
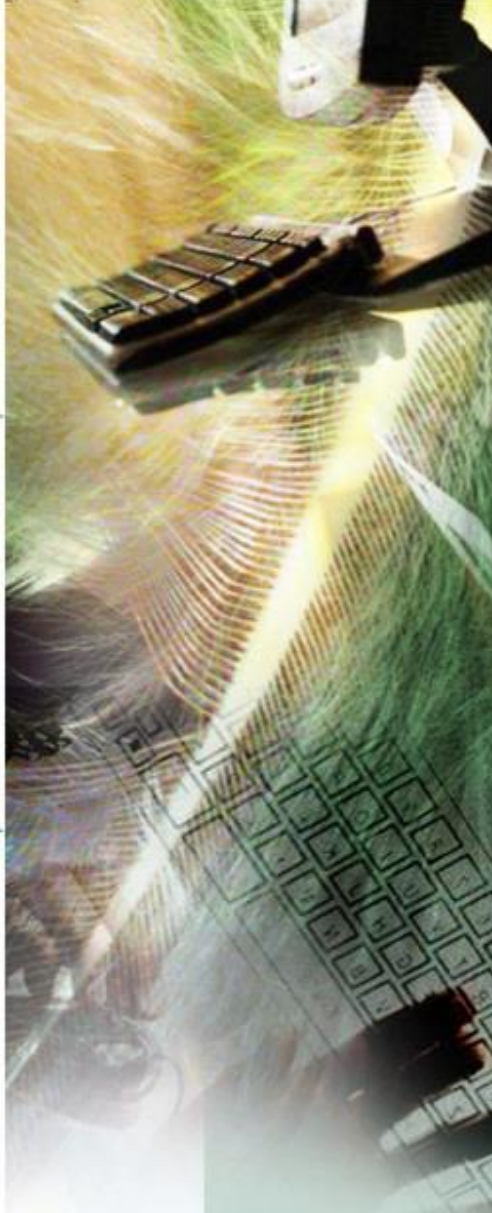

2. Touch Driver Setup

This chapter provides an overview that describes the steps required for installing, uninstalling, and configuring the touch driver.



2.1. Windows CE 5.0

This section describes how to install, calibrate and uninstall the touch driver for the WP-8000 series and WP-5000 series, and gives details of how to obtain drivers for other CE5 devices.

2.1.1. USB Touch Driver

Two USB touch drivers are available. The first is for WP-8000 series modules and WP-5000 series modules of ICP DAS PAC controllers, and the second is for other Windows CE5.0 systems.

WP-8000 series:

WP-8131/WP-8431/WP-8831, WP-8141/WP-8441/WP-8841

WP-8137/WP-8437/WP-8837, WP-8147/WP-8447/WP-8847

WP-8139/WP-8431/WP-8839, WP-8141/WP-8441/WP-8849

WP-8136/WP-8431/WP-8836, WP-8141/WP-8441/WP-8846

WP-5000 series:

WP-5141/WP-5441-OD/WP-5149/WP-5449-OD/WP-5147/WP-5447-OD/

WP-5146/WP-5446-OD

2.1.1.1. Installation for WinPAC-8000 and WinPAC-5000

The following procedure describes how to install the PenMount USB touch driver.

1. Copy the driver from the CD-ROM to the WinPAC.

The “PenMount_USB_TOUCH_Vyyyymmdd.CAB” driver file can be obtained from:

[name]	Driver path
TP-2070/TP-3080/TP-5120	CD:\[name]\Driver\WinCE\V5.0\WP-8000 and WP-5000 device
TPM-4100_TP-4100/	For example:
TP-6150/TP-7170	CD:\TP-6150\Driver\WinCE\V5.0\WP-8000 and WP-5000 device

Or go to the “\System_Disk\External_device_driver\” folder on the WinPAC.

2. Double-click the “PenMount_USB_TOUCH_Vyyyymmdd.CAB” file.

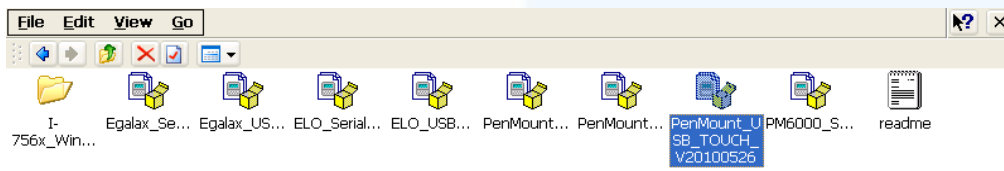

3. Show one of two dialogs below. Just click the “OK” button to continue installation.

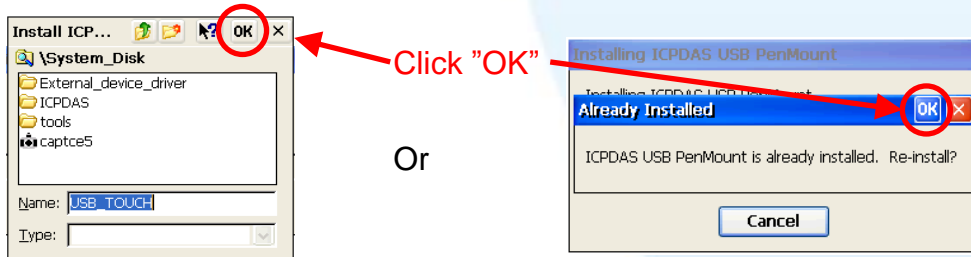

4. From the “Start” menu, click ”Programs”→Open the “WinPAC Utility”, and then click the “Save and Reboot” option from the “File” menu.

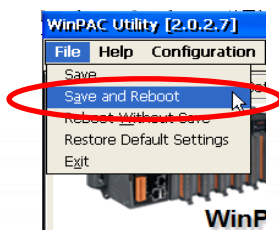

Tips

1. Appendix A → “A.1. Don’t install USB and serial touch driver simultaneously in a device”
-

2.1.1.2. Configuration for WinPAC-8000 and WinPAC-5000

Calibration

1. From the “Start” menu, click “Programs”→”USB_TOUCH”→”PenMount”→”Calibration”.

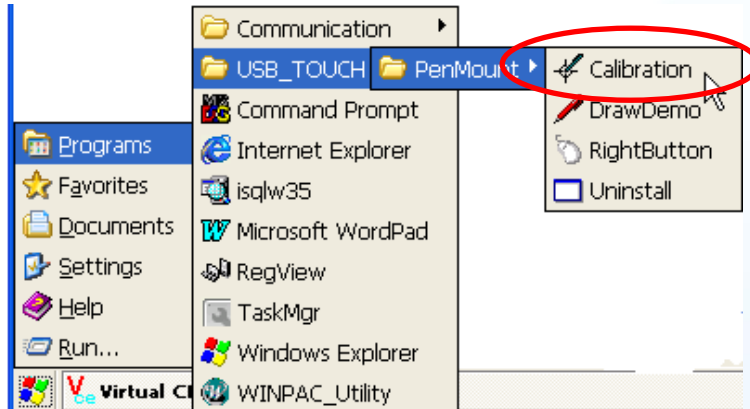

2. Follow the instructions on the screen to begin calibration.



3. Once calibration has been completed, from the “Start” menu, click ”Programs”→Open the “WinPAC Utility”, and then click the “Save and Reboot” option from the “File” menu.

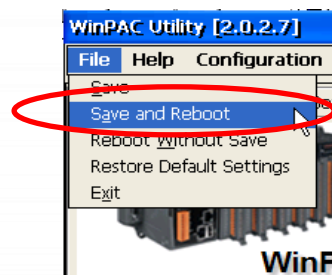

Simulating the Right Mouse Button

1. From the Start menu, click “Programs”→”USB_TOUCH” →”PenMount”→”RightButton”.

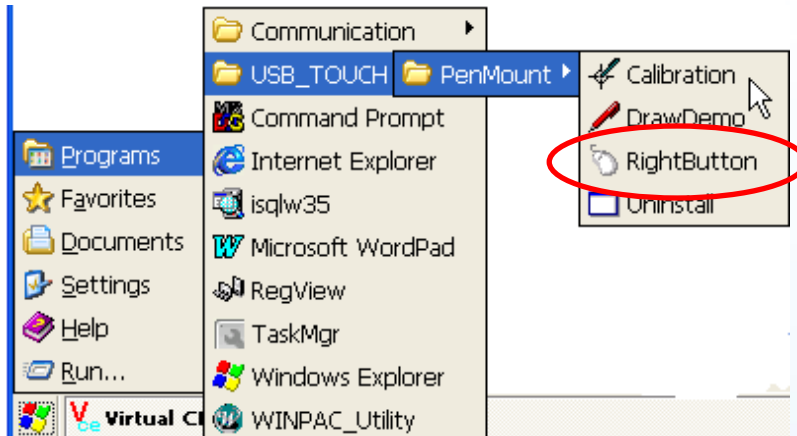

2. Show a screen below (Left picture)→ Click the “mouse” → Turn into right picture.



3. **Click any object:** Click “My device” to test if the function of “RightButton” works. If the screen below shows, the function of “RightButton” works.

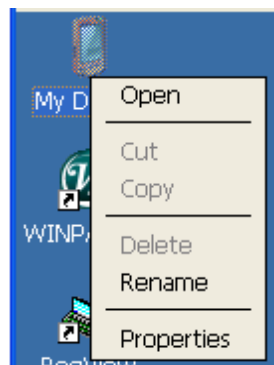

4. The operation of the right mouse button can be simulated by repeating Step 2 and Step 3 for any object.

2.1.1.3. Uninstalling the WinPAC-8000 and WinPAC-5000

The following procedure describes how to uninstall the PenMount USB touch driver.

1. From the “Start” menu, click “Programs”→”USB_TOUCH”
→”PenMount”→”Uninstall”.

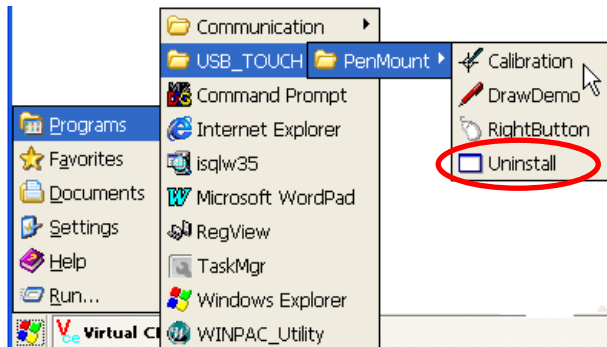

2. A warning pop-up will be displayed asking you to confirm the uninstall request. Click the “Yes” button to uninstall the driver.

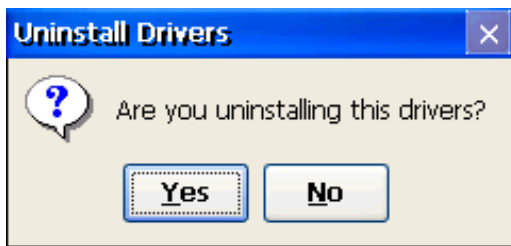

3. Once the uninstallation process is complete, a dialog will displayed requesting that you reboot the system. Click the “Yes” button to reboot the WinPAC immediately, or click “NO” if you intend to reboot at a later time.

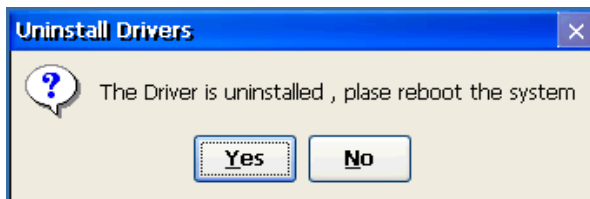

2.1.1.4. Other Windows CE5.0 Devices

The driver for using with other windows CE5.0 devices can be obtained from the PenMount website to download the latest driver. We are use PenMount 6000 chip.

PenMount website: <http://www.salt.com.tw/en>

2.1.2. Serial Touch Driver

Two serial touch drivers are available. The first is for WP-8000 series modules and WP-5000 series modules of ICPDAS PAC controllers, and the second is for other Windows CE5.0 systems.

WP-8000 series:

WP-8131/WP-8431/WP-8831, WP-8141/WP-8441/WP-8841

WP-8137/WP-8437/WP-8837, WP-8147/WP-8447/WP-8847

WP-8139/WP-8431/WP-8839, WP-8141/WP-8441/WP-8849

WP-8136/WP-8431/WP-8836, WP-8141/WP-8441/WP-8846

WP-5000 series:

WP-5141/WP-5441-OD/WP-5149/WP-5449-OD/WP-5147/WP-5447-OD/

WP-5146/WP-5446-OD

2.1.2.1. Installation for WinPAC-8000 and WinPAC-5000

The following procedure describes how to install the PenMount serial touch driver. Note that **the default COM port for serial touch driver is COM4**.

There is a **RS-232 cable in the shipping package** (Sec.1). The user can directly use this cable to **connect the monitor with COM4 of WinPAC-8000 to use serial touch driver to do a touch operation by serial way**. If the user wants to use other com port, please note the position of TX and RX of COM port. About the pin assignment, please refer to the user manual of the WinPAC-8000



Warning:

The WinPAC-5000 series doesn't include a COM4, so please refer to "Changing the COM Port" in Sec.2.1.2.2 for details of how to change the COM Port to the specified COM Port.

1. Copy the driver from the CD-ROM to the WinPAC.
The "PenMount_Serial_TOUCH_Vyyyymmdd(PM6000R).CAB" driver file can be obtained from:

[name]	Driver path
TP-2070/TP-3080/TP-5120/ TPM-4100_TP-4100/TP-6150 /TP-7170	CD:\[name]Driver\WinCE\V5.0\WP-8000 and WP-5000 device For example: CD:\TP-6150 \Driver\WinCE\V5.0\WP-8000 and WP-5000 device

Or go to the “\System_Disk\External_device_driver\” folder on the WinPAC.

2. Double-click the “PenMount_Serial_TOUCH_Vyyyymmdd(PM6000R).CAB” file.

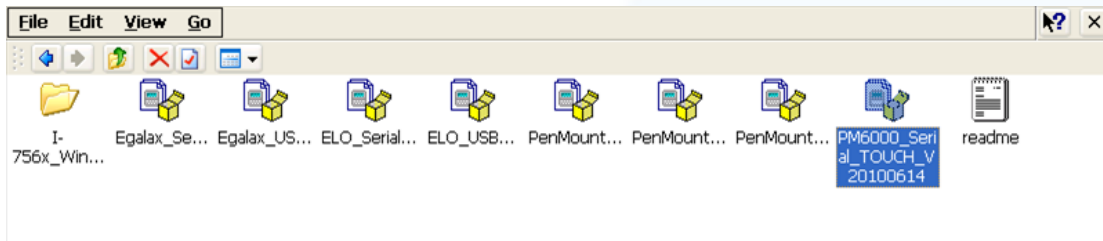

3. Show one of two dialogs below. Just click “OK” button to continue installation.

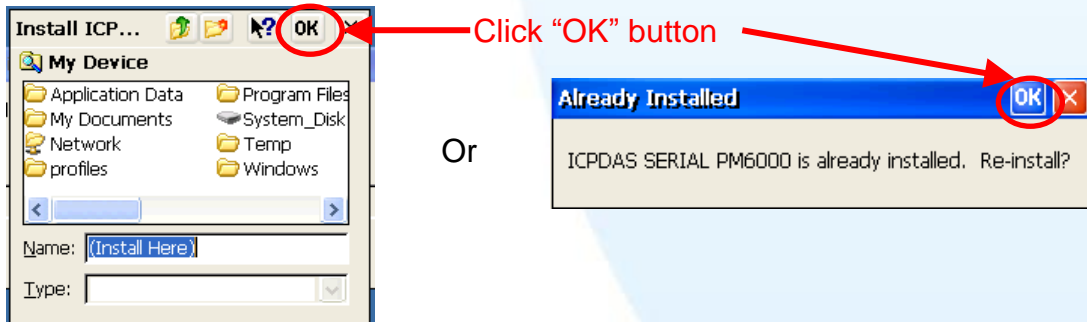

4. From the “Start” menu, click ”Programs”→Open the “WinPAC Utility”, and then click the “Save and Reboot” option from the “File” menu.

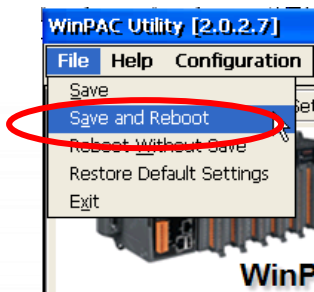

Tips

1. Appendix A → “A.1. Don’t install USB and serial touch driver simultaneously in a device”
 2. Appendix A → “A.2. Don’t plug USB cable when using serial touch driver”
-

2.1.2.2. Configuration for WinPAC-8000 and WinPAC-5000

Calibration

1. From the “Start” menu, click “Programs”→”Serial_TOUCH”
→”PenMount”→”Calibration”.

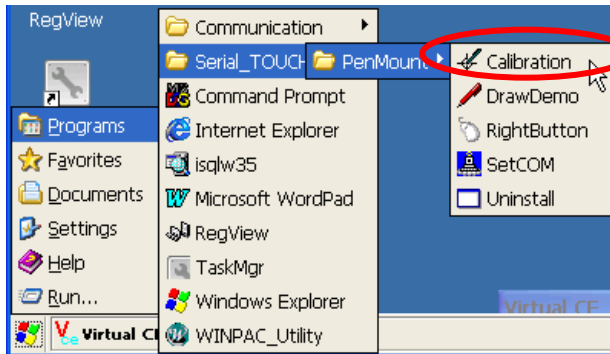

2. Follow the instruction on the screen to begin calibration.

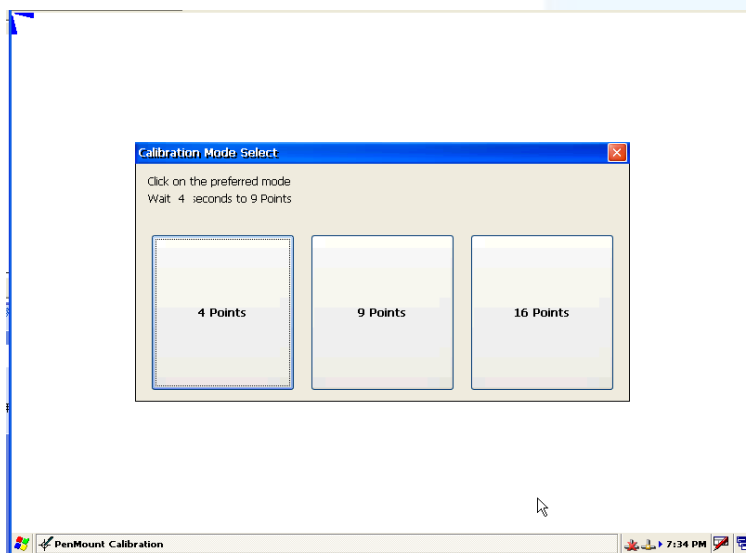

3. Once calibration has been completed, from the “Start” menu, click ”Programs”→Open the “WinPAC Utility”, and then click the “Save and Reboot” option from the “File” menu.

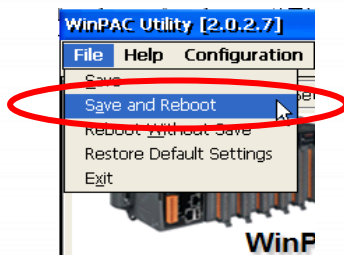

Changing the COM Port

1. From the “Start” menu, click “Programs”→”Serial_TOUCH”
→”PenMount”→”SetCOM”.

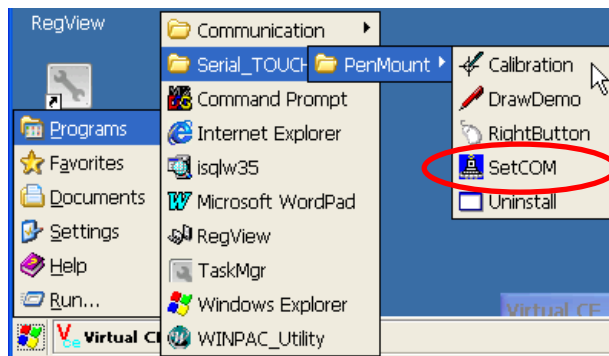

2. In the pop-up dialog, select the COM Port you wish to use as default and click the “Set” button to save the changes.

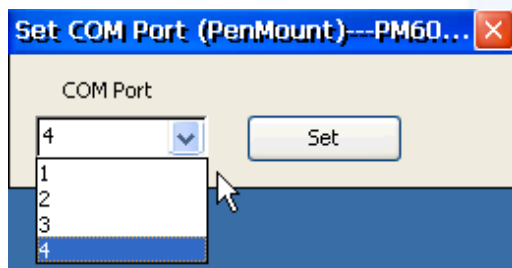

3. From the “Start” menu, click ”Programs”→Open the “WinPAC Utility”, and then click the “Save and Reboot” option from the “File” menu.

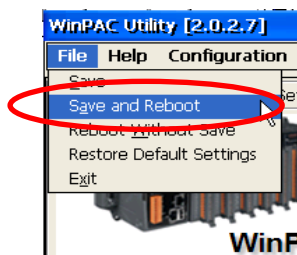

4. Disconnect the cable from the current COM Port and reconnect it to the specified COM Port.

Simulating the Right Mouse Button

For details of how to configure right mouse button simulation, please refer to the process describes in “Simulating the Right Mouse Button” in [Sec.2.1.1.2](#)

2.1.2.3. Uninstalling the WinPAC-8000 and WinPAC-5000

The following procedure describes how to uninstall the PenMount serial touch driver.

1. From the “Start” menu, click “Programs”→”Serial_TOUCH”
→”PenMount”→”Uninstall”

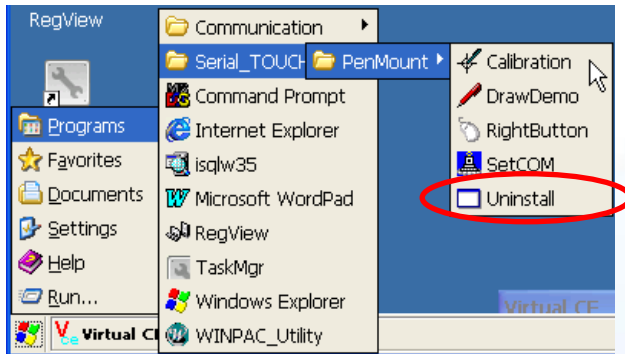

2. A warning pop-up will be displayed asking you to confirm the uninstall request. Click the “Yes” button to uninstall the driver.

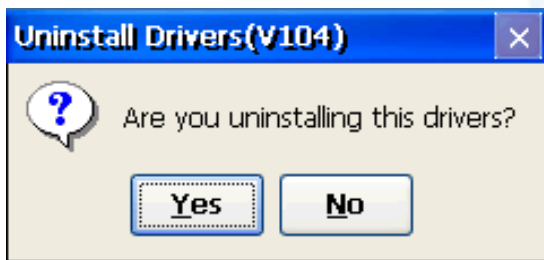

3. Once the uninstallation process is complete, a dialog will displayed requesting that you reboot the system. Click the “Yes” button to reboot the WinPAC immediately, or click “NO” if you intend to reboot at a later time.

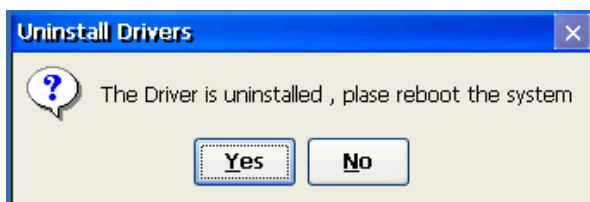

2.1.2.4. Other Windows CE5.0 Devices

The driver for using with other windows CE5.0 devices can be obtained from the PenMount website to download the latest driver. We are use PenMount 6000 chip.

PenMount website: <http://www.salt.com.tw/en>



2.2. Windows CE 6.0

This section describes how to install, calibrate and uninstall the touch driver for the XP-8000-CE6 series, and gives details of how to obtain drivers for other CE6 devices.

2.2.1. USB Touch Driver

Two USB touch drivers are available. The first is for XP-8000-CE6 series modules of ICP DAS PAC controllers and, and the second is for other Windows CE6.0 systems.

XP-8000-CE6 series:

1. Using the ATOM CPU:

XP-8141-Atom-CE6/XP-8341-Atom-CE6/XP-8741-Atom-CE6

XP-8147-Atom-CE6/XP-8347-Atom-CE6/XP-8747-Atom-CE6

XP-8149-Atom-CE6/XP-8349-Atom-CE6/XP-8749-Atom-CE6

2. Using the LX800 CPU:

XP-8041-CE6/XP-8341-CE6/XP-8741-CE6

XP-8047-CE6/XP-8347-CE6/XP-8747-CE6

XP-8049-CE6/XP-8349-CE6/XP-8749-CE6

XP-8046-CE6/XP-8346-CE6/XP-8746-CE6

2.2.1.1. Installation for XP-8000-CE6

The following procedure describes how to install the PenMount USB touch driver.

1. Copy the driver from the CD-ROM to the XP-8000-CE6.

The “PenMount_USB_TOUCH_Vxx_yyyymmdd_XPAC_CE6.CAB” driver file can be obtained from:

[name]	Driver path
TP-2070/TP-3080/ TPM-4100_TP-4100/ TP-5120/TP-6150//TP-7170	CD:[name]\Driver\WinCE\6.0\XP-8000-CE6 device\ For example: CD:\TP-2070\Driver\WinCE\6.0\XP-8000-CE6 device\

Or go to the “\System_Disk\External_device_driver” folder on the XP-8000-CE6.

2. Double-click the “PenMount_USB_TOUCH_Vxx_yyyymmdd_XPAC_CE6.CAB” file.

Tips & Warnings



The driver (*.cab) file can only be used once. If you attempt to use it to install driver a second time, a warning dialog with a message similar to “<FileName> is not a valid Windows CE Setup file” will be displayed advising that the setup has failed. Please re-download a new (*.cab) file to use.



3. Depending on the type of CPU, one of two dialog windows will be displayed. Click the “OK” button to continue with the installation.

Using the ATOM CPU

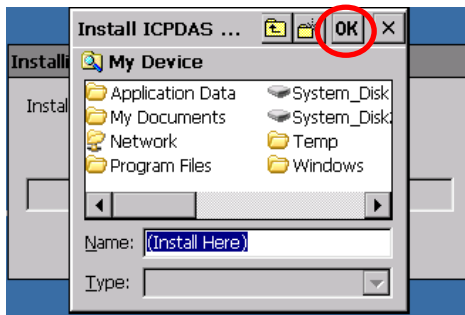

Or

Using the LX800 CPU

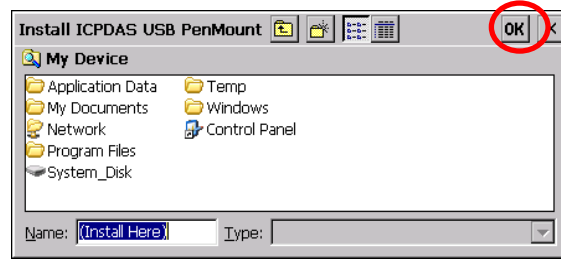

4. Once the installation has been completed, a dialog will be displayed advising that the system needs to be rebooted. Click the “OK” button to reboot the XP-8000-CE6.

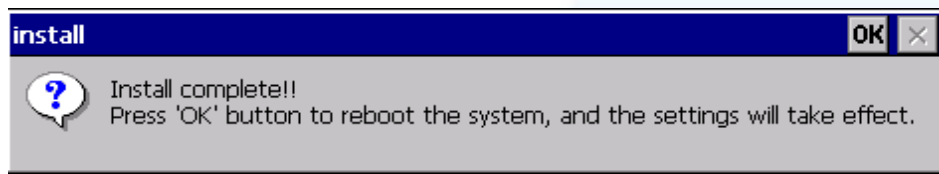

Tips

1. Appendix A → “A.1. Don’t install USB and serial touch driver simultaneously in a device”

2.2.1.2. Configuration for XP-8000-CE6

Calibration

1. From the “Start” menu, click “Programs”→”USB_TOUCH” →”PenMount”→”Calibration”.

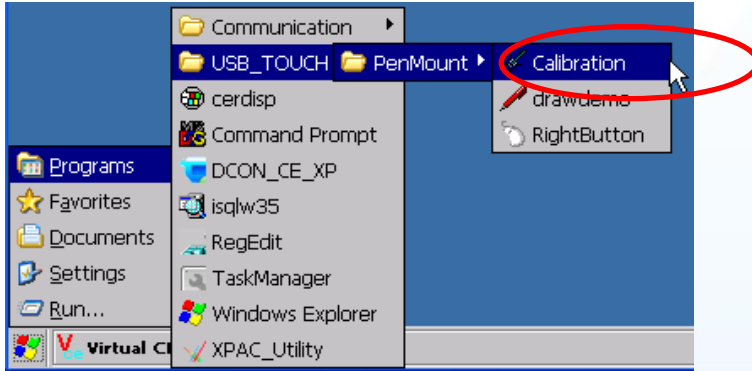

2. Following the instructions on the screen to begin calibration.

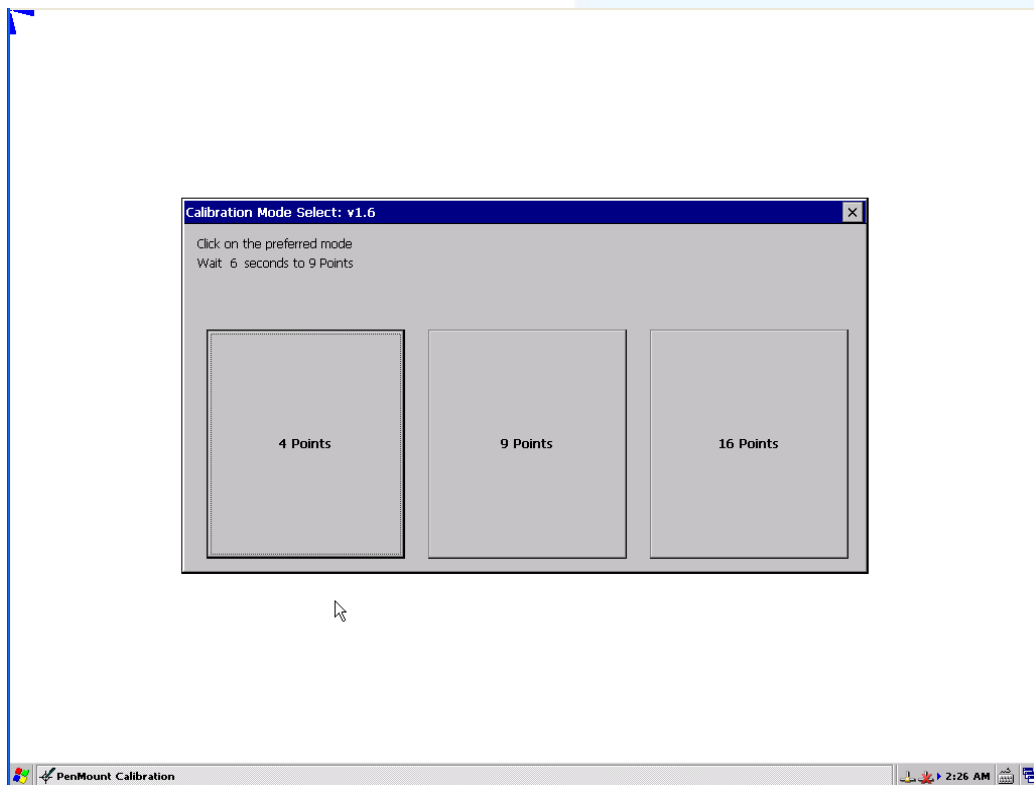

Simulating the Right Mouse Button

For details of how to simulate right mouse button functions, please refer to the process described in “Simulating the Right Mouse Button” in [Sec. 2.1.1.2](#)

2.2.1.3. Uninstalling the XP-8000-CE6

The following procedure describes how to uninstall the PenMount USB touch driver.

1. From the “Start” menu, click “Settings”→”Control Panel”.

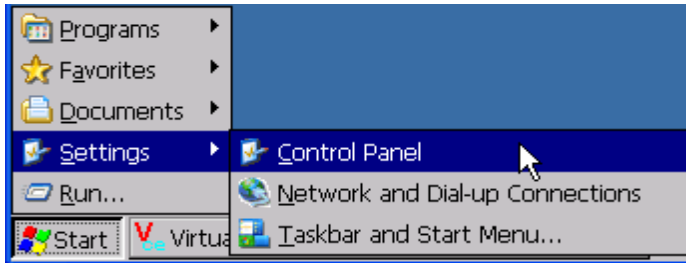

2. Double click the “Remove Programs” icon and select “ICPDAS USB PenMount” from the “Programs” panel in the “Remove Programs” dialog box and then click the “Remove” button. When the warning pop-up, click “Yes” button to permanently uninstall the driver.

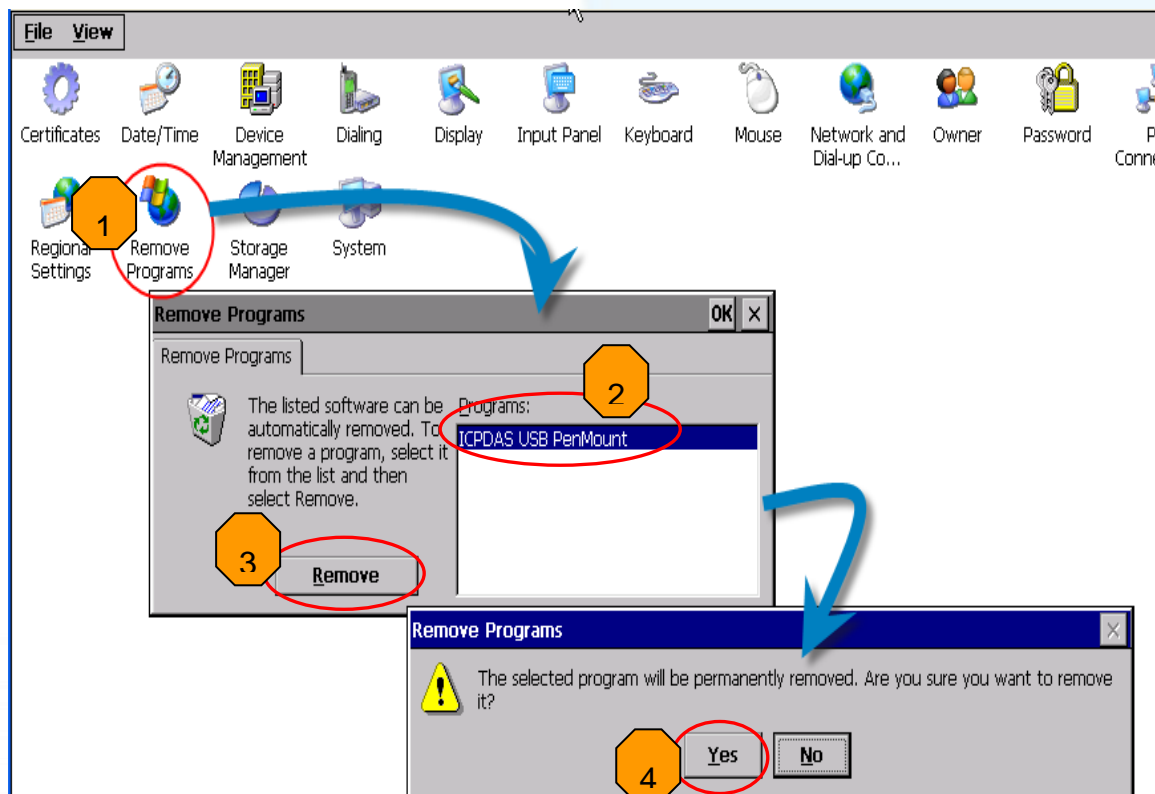

3. Once the uninstallation process is complete, a dialog will be displayed requesting that you reboot the system. Click the “Yes” button to reboot immediately or click the “No” button if you intend to reboot at a later time.

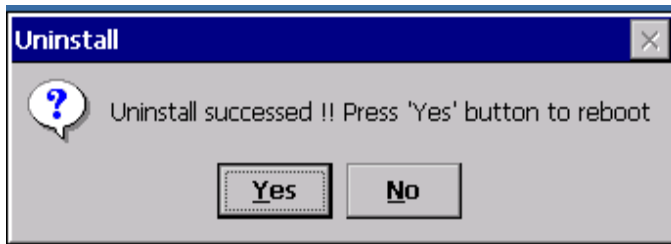

2.2.1.4. Other Windows CE6.0 Devices

The driver for using with other windows CE6.0 devices can be obtained from the PenMount website to download the latest driver. We are use PenMount 6000 chip.

PenMount website: <http://www.salt.com.tw/en>

2.2.2. Serial Touch Driver

Two serial touch drivers are available. The first is for XP-8000-CE6 series modules of ICPDAS PAC controllers and the second is for other Windows CE6.0 systems.

XP-8000-CE6 series:

1.Using ATOM CPU

XP-8141-Atom-CE6/XP-8341-Atom-CE6/XP-8741-Atom-CE6

XP-8147-Atom-CE6/XP-8347-Atom-CE6/XP-8747-Atom-CE6

XP-8149-Atom-CE6/XP-8349-Atom-CE6/XP-8749-Atom-CE6

2.Using LX800 CPU

XP-8041-CE6/XP-8341-CE6/XP-8741-CE6

XP-8047-CE6/XP-8347-CE6/XP-8747-CE6

XP-8049-CE6/XP-8349-CE6/XP-8749-CE6

XP-8046-CE6/XP-8346-CE6/XP-8746-CE6

2.2.2.1. Installation for XP-8000-CE6

The following procedure describes how to install the PenMount Serial touch driver.

Note that the default COM Port for the touch driver is COM5.

There is a **RS-232 cable in the shipping package (Sec.1)**. The user can directly use this cable to **connect the monitor with COM5 of XP-8000-CE6 to use serial touch driver to do a touch operation by serial way**. If the user wants to use other com port, please note the position of TX and RX of COM port. About the pin assignment, please refer to the user manual of the XP-8000-CE6



1. Copy the driver from the CD-ROM to the XP-8000-CE6 device.

The “PenMount_Serial_TOUCH_Vxx_yyyymmdd_XPAC_CE6(PM6000R).CAB” file can be obtained from:

[name]	Driver path
--------	-------------

TP-2070/TP-3080/ TPM-4100_TP-4100/ TP-5120/TP-6150/TP-7170	CD:\[name]\Driver\WinCE\6.0\XP-8000-CE6 device\ For example: CD:\TP-2070\Driver\WinCE\6.0\XP-8000-CE6 device\
--	---

Or go to the “\System_Disk\External_device_driver” folder on the XP-8000-CE6.

2. Double click the “PenMount_Serial_TOUCH_Vxx_yyyymmdd_XPAC_CE6(PM6000R).CAB” file.

Tips & Warnings



The driver (*.cab) file can only be used once. If you attempt to use it to install driver a second time, a warning dialog with a message similar to “<filename>**is not a valid Windows CE Setup file**” will be displayed advising that the setting has failed. Please re-download a new (*.cab) file to use.



3. Depending on the type of CPU, one of two dialog windows will be displayed.

If the controller use the ATOM CPU, the following will be displayed.



Alternatively, if the controller use the LX800 CPU, the following will be displayed.

Or

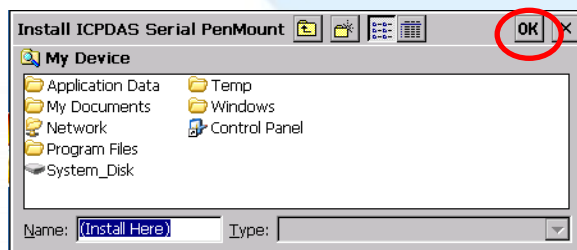

Click the “OK” button to continue with the installation.

4. Once the installation has been completed, a dialog will be displayed advising that the system needs to be rebooted. Click the “OK” button to reboot the XP-8000-CE6.

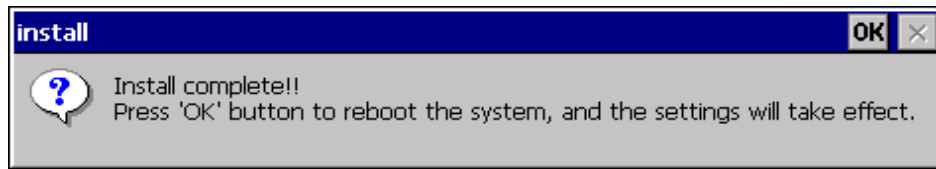

Tips

1. Appendix A → “A.1. Don’t install USB and serial touch driver simultaneously in a device”
 2. Appendix A → “A.2. Don’t plug USB cable when using serial touch driver”
-

2.2.2.2. Configuration for XP-8000-CE6

Calibration

1. From the “Start” menu, click “Programs”→”Serial_TOUCH”→”PenMount”→”Calibration”

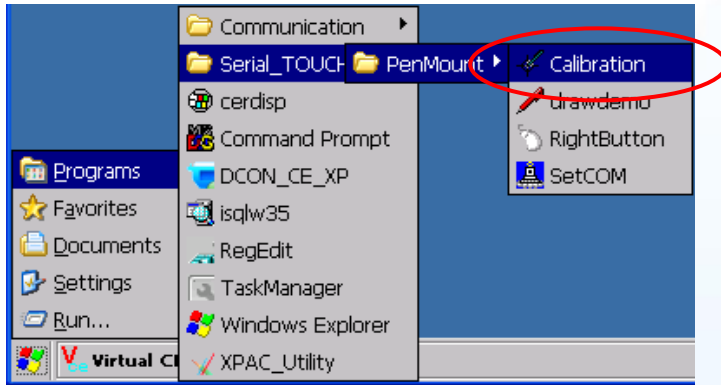

2. Follow the instruction on the screen to begin calibration. You will be presented with one of two screens depending on the CPU you are using.

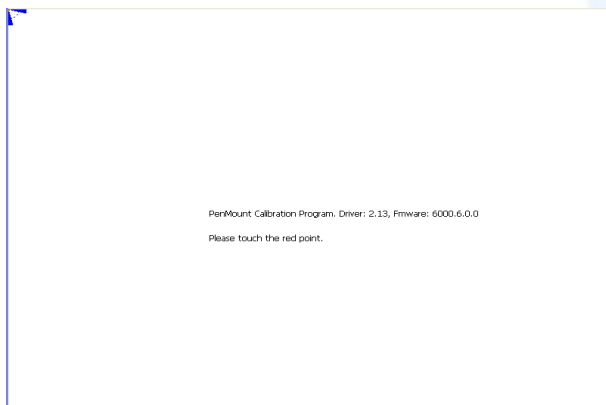

If you are using the LX800 CPU, the screen will look like this.

If you are using the ATOM CPU, the screen will look like this.

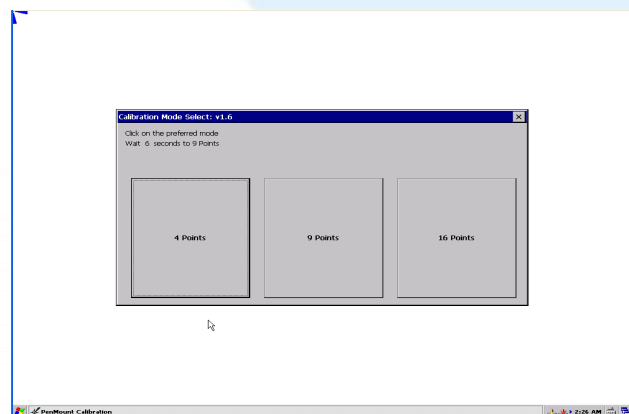

Change the COM Port

1. From the “Start” menu, click “Programs”→”Serial_TOUCH”
→”PenMount”→”SetCOM”.

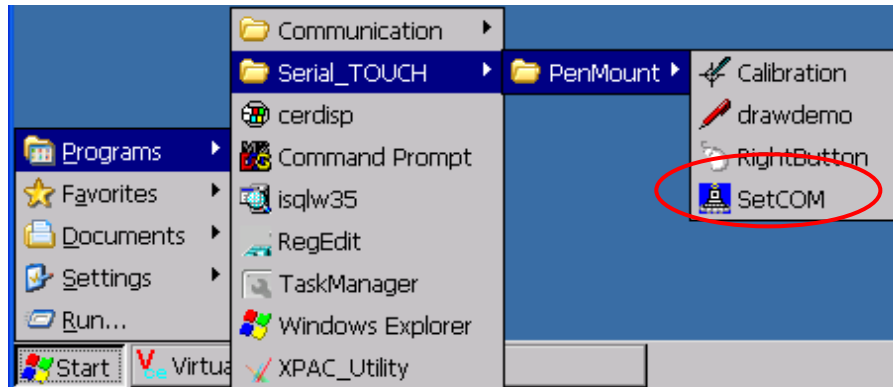

2. Just choose the COM port→Click “Set” button→Click “Yes” button to reboot the system. The baudrate for the touch monitor is 19200 bps, so please don't modify the baudrate of touch driver.

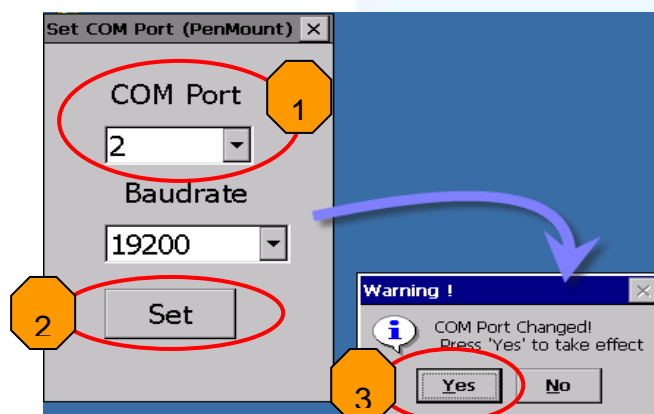

Simulating Right Mouse Button

For details of how to configure right mouse button simulation, please refer to the process describes in “Simulating the Right Mouse Button” in [Sec.2.1.1.2](#)

2.2.2.3. Uninstalling the XP-8000-CE6

The following procedure describes how to uninstall the PenMount serial touch driver.

1. From the “Start” menu, click “Settings”→”Control Panel”.



2. Double click the “Remove Programs” icon and select “ICPDAS Serial PenMount” from the “Programs” panel in the “Remove Programs” dialog box and then click the “Remove” button. When the warning pop-up, click “Yes” button to permanently uninstall the driver.

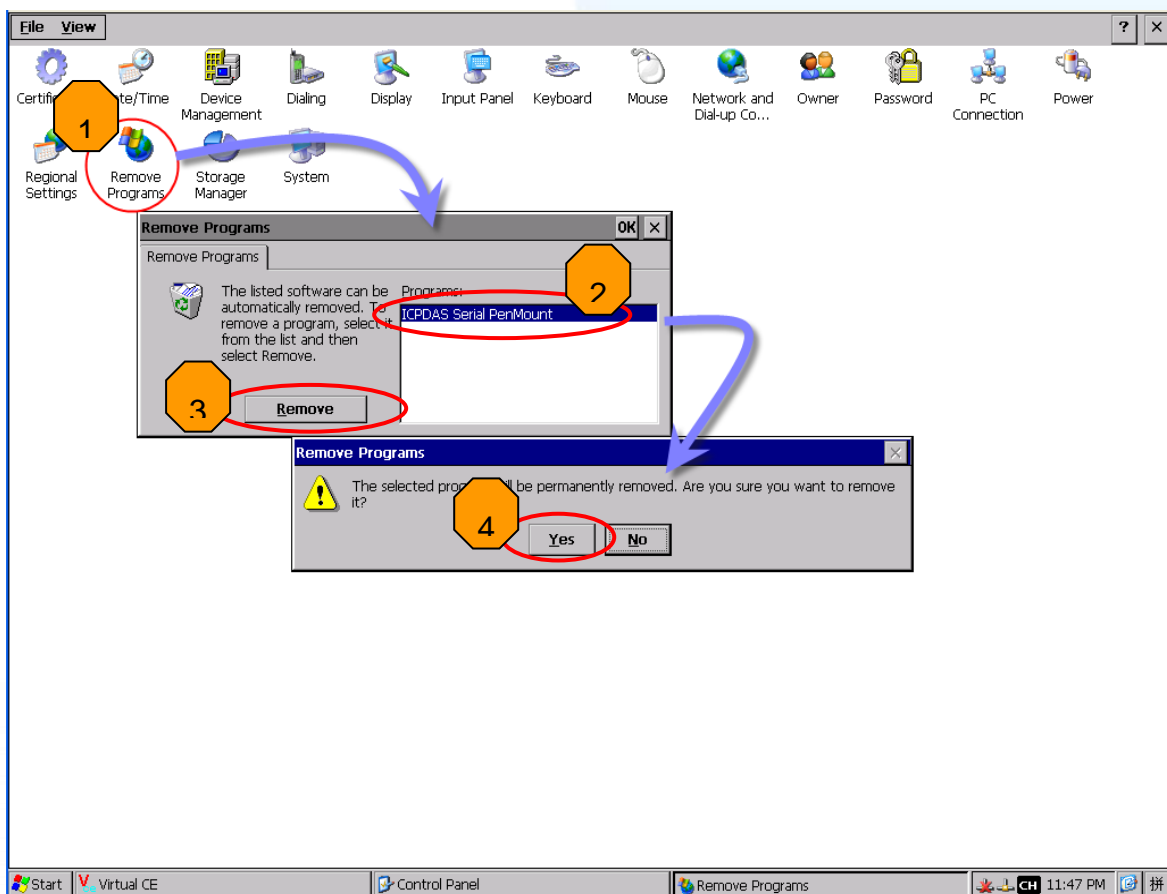

3. Once the uninstallation process is complete, a dialog will be displayed requesting that you reboot the system. Click the “Yes” button to reboot immediately or click the “No” button if you intend to reboot at a later.

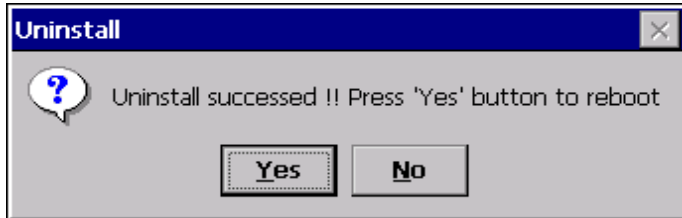

2.2.2.4. Other Windows CE 6.0 Device

The driver for using with other windows CE6.0 devices can be obtained from the PenMount website to download the latest driver. We are use PenMount 6000 chip.

PenMount website: <http://www.salt.com.tw/en>



2.3. Windows CE 7.0

This section describes how to install, calibrate and uninstall the touch driver for the WP-5000-CE7 series, and gives details of how to obtain drivers for other CE7 devices.

2.3.1. USB Touch Driver

Two USB touch drivers are available. The first is for WP-5000-CE7 series modules of ICP DAS PAC controllers and, and the second is for other Windows CE7.0 systems.

WP-5000-CE7 series:

WP-5231-CE7/WP-5238-CE7

2.3.1.1. Installation for WinPAC-5000-CE7

The following procedure describes how to install the PenMount USB touch driver.

1. Copy the driver from the CD-ROM to the WinPAC.

The “PenMount_USB_TOUCH_Vyyyymmdd.CAB” driver file can be obtained from:

[name]	Driver path
TP-2070/TP-3080/TP-5120	CD:\[name]\Driver\WinCE\V7.0\WP-5000-CE7 device
TPM-4100_TP-4100/	For example:
TP-6150/TP-7170	CD:\TP-6150\Driver\WinCE\V7.0\WP-5000-CE7 device

Or go to the “\System_Disk\External_device_driver\” folder on the WinPAC.

2. Double-click the “PenMount_USB_TOUCH_Vyyyymmdd.CAB” file.

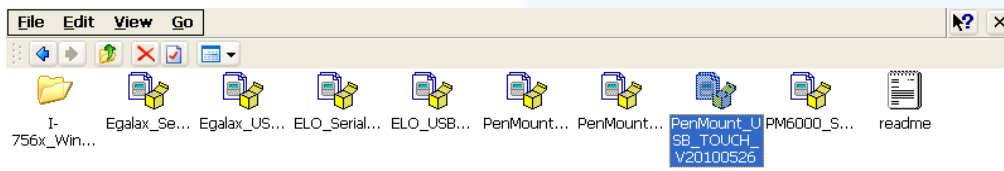

3. Show one of two dialogs below. Just click the “OK” button to continue installation.

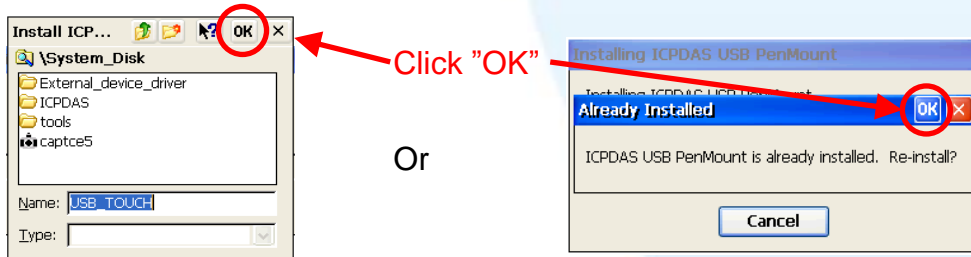

4. From the “Start” menu, click ”Programs”→Open the “PAC_Utility”
 - a. If HIVE Registry is “Auto Save Flash(Default)”, click “reboot”

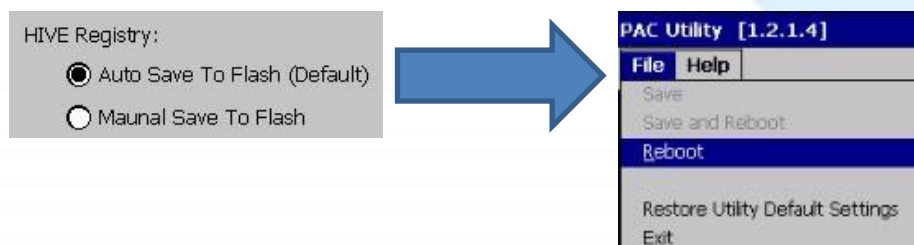

b. If HIVE Registry is “Manual Save To Flash”, click “Save and Reboot”

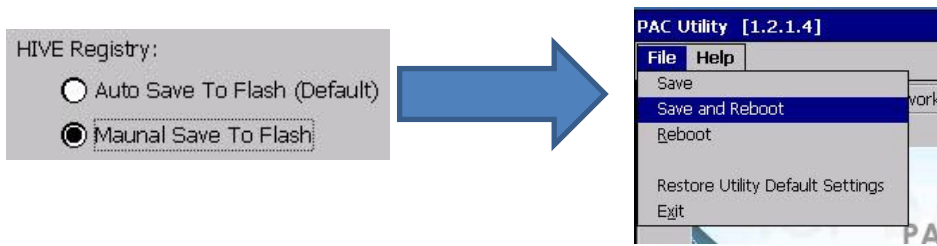

Tips

1. Appendix A → “A.1. Don’t install USB and serial touch driver simultaneously in a device”
-

2.3.1.2. Configuration for WinPAC-5000-CE7

Calibration

1. Go to “System_Disk\Drivers\USB_TOUCH\PenMount\BIN” and double click “calibrate.exe”.

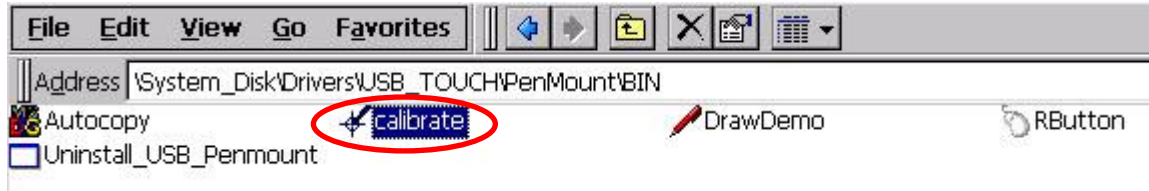

2. Follow the instructions on the screen to begin calibration.

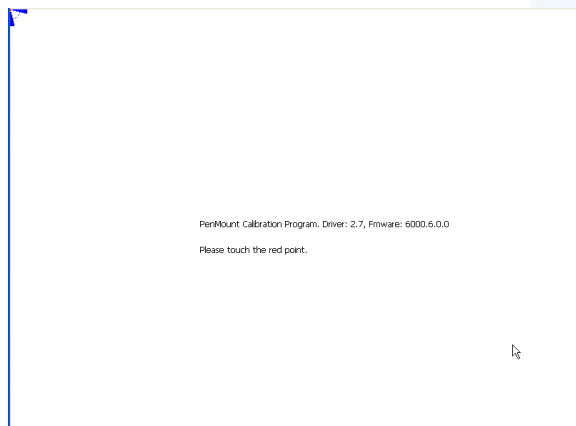

3. Once calibration has been completed, from the “Start” menu, click ”Programs”→Open the “PAC Utility”
 - a. If HIVE Registry is “Auto Save Flash(Default)”, click “reboot”

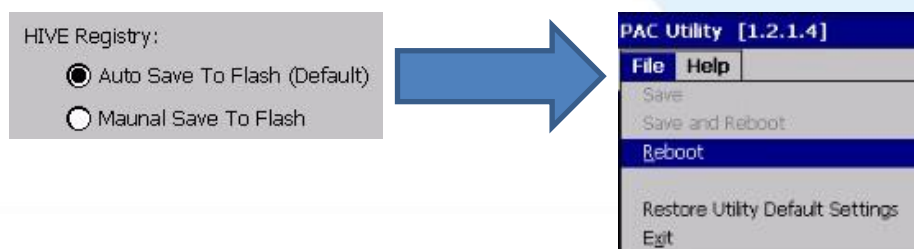

- b. If HIVE Registry is “Manual Save To Flash”, click “Save and Reboot”

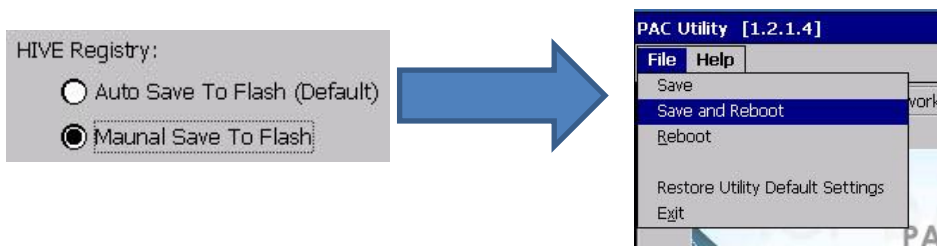

Simulating the Right Mouse Button

1. Go to “System_Disk\Drivers\USB_TOUCH\PenMount\BIN” and double click “rbutton.exe”.



2. Show a screen below (Left picture) → Click the “mouse” → Turn into right picture.



3. **Click any object:** Click “My device” to test if the function of “RightButton” works. If the screen below shows, the function of “RightButton” works.

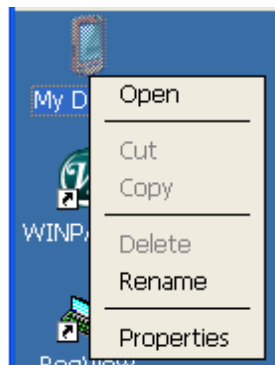

4. The operation of the right mouse button can be simulated by repeating Step 2 and Step 3 for any object.

2.3.1.3. Uninstalling the WinPAC-5000-CE7

The following procedure describes how to uninstall the PenMount USB touch driver.

1. Go to “System_Disk\Drivers\USB_TOUCH\PenMount\BIN” and double click “Uninstall_USB_Penmount.exe”.

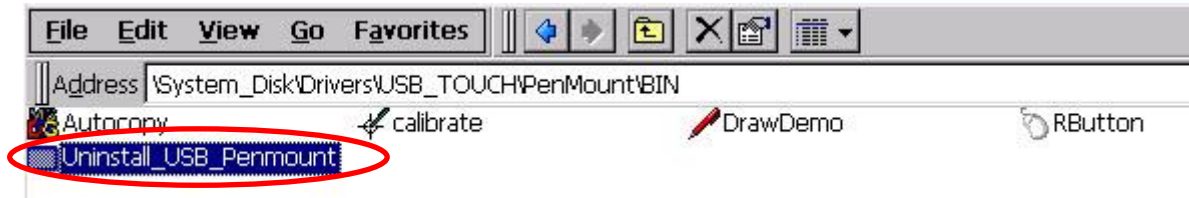

2. A warning pop-up will be displayed asking you to confirm the uninstall request. Click the “Yes” button to uninstall the driver.

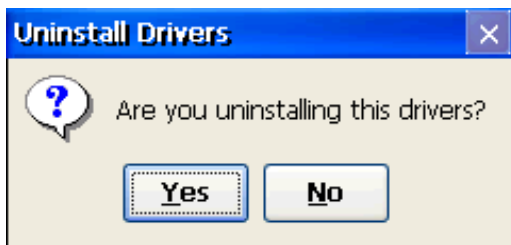

3. Once the uninstallation process is complete, a dialog will displayed requesting that you reboot the system. Click the “Yes” button to reboot the WinPAC immediately, or click “NO” if you intend to reboot at a later time.

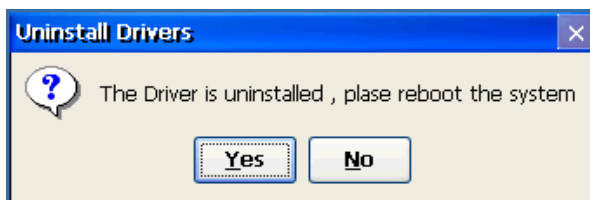

2.3.1.4. Other Windows CE7.0 Devices

The driver for use with other windows CE7.0 devices can be obtained from the PenMount website to download the latest driver. We are use PenMount 6000 chip.

PenMount website: <http://www.salt.com.tw/en/>

2.3.2. Serial Touch Driver

Two serial touch drivers are available. The first is for WP-5000-CE7 series modules of ICPDAS PAC controllers, and the second is for other Windows CE7.0 systems.

WP-5000-CE7 series:

WP-5231-CE7/WP-5238-CE7

2.3.2.1. Installation for WinPAC-5000-CE7

The following procedure describes how to install the PenMount serial touch driver. Note that **the default COM port for serial touch driver is COM4**.

Please use COM1 or COM2 to communicate with the touch panel. Please note the position of TX and RX of COM port. About the pin assignment, please refer to the user manual of the WinPAC-5000-CE7.



Warning:

The WinPAC-5000-CE7 series doesn't include a COM4, so please refer to "Changing the COM Port" in Sec.2.3.2.2 for details of how to change the COM Port to the specified COM Port.

1. Copy the driver from the CD-ROM to the WinPAC.

The "PenMount_Serial_TOUCH_Vyyyyymmdd(PM6000R).CAB" driver file can be obtained from:

[name]	Driver path
TP-2070/TP-3080/TP-5120/ TPM-4100_TP-4100/TP-6150 /TP-7170	CD:\[name]\Driver\WinCE\V7.0\WP-5000-CE7 device For example: CD:\TP-6150 \Driver\WinCE\V7.0\WP-5000-CE7 device

Or go to the "\System_Disk\External_device_driver\" folder on the WinPAC.

2. Double-click the "PenMount_Serial_TOUCH_Vyyyyymmdd(PM6000R).CAB" file.



3. Show one of two dialogs below. Just click “OK” button to continue installation.

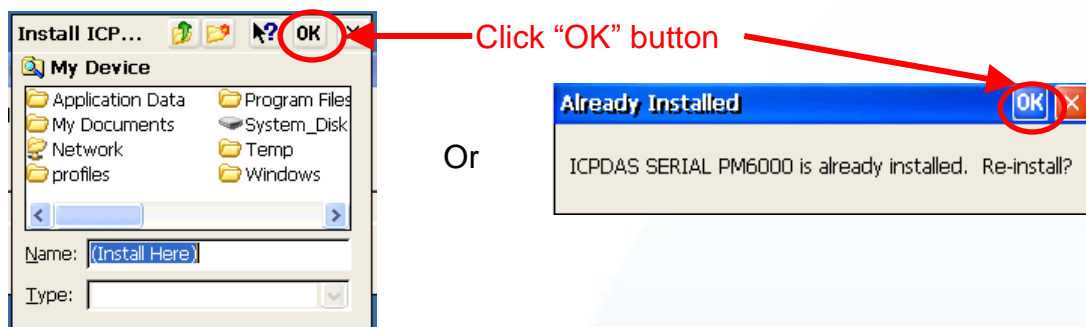

4. From the “Start” menu, click ”Programs”→Open the “PAC Utility”:
 - a. If HIVE Registry is “Auto Save Flash(Default)”, click “reboot”

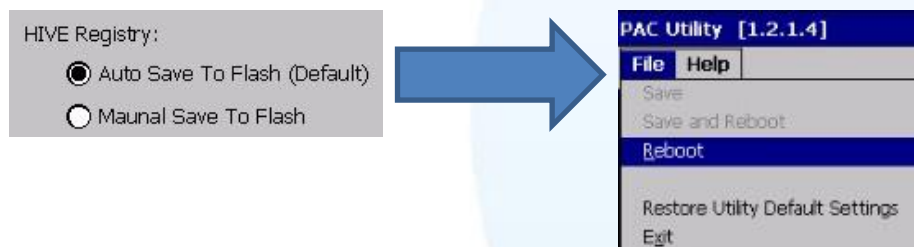

- b. If HIVE Registry is “Manual Save To Flash”, click “Save and Reboot”

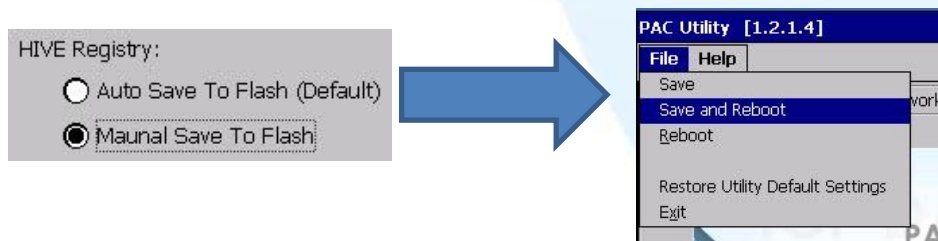

Tips

1. Appendix A → “A.1. Don’t install USB and serial touch driver simultaneously in a device”
2. Appendix A → “A.2. Don’t plug USB cable when using serial touch driver”

2.3.2.2. Configuration for WinPAC-5000-CE7

Calibration

1. Go to “System_Disk\Drivers\Serial_TOUCH\PenMount\BIN” and double click “calibrate.exe”.

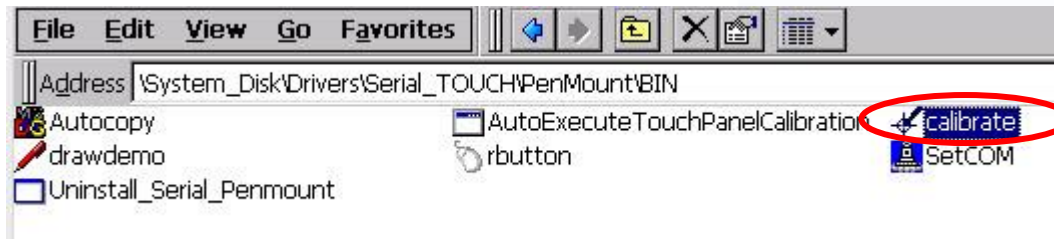

2. Follow the instruction on the screen to begin calibration.

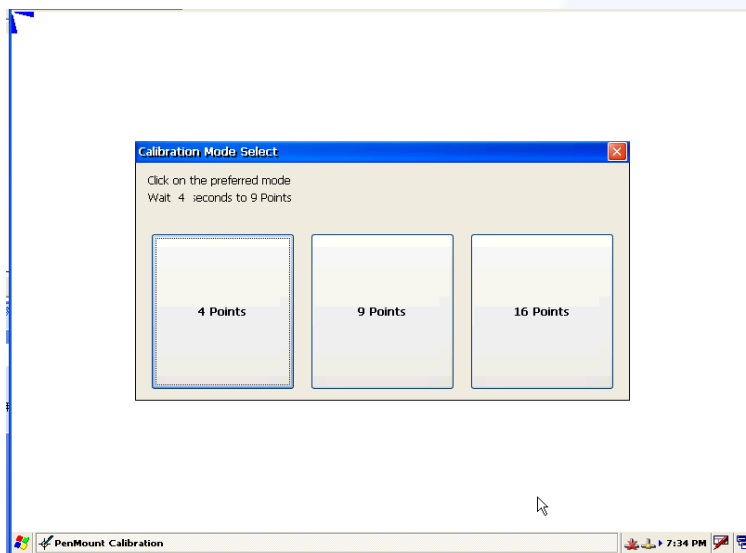

3. Once calibration has been completed, from the “Start” menu, click ”Programs”→Open the “PAC Utility”:
 - a. If HIVE Registry is “Auto Save Flash(Default)”, click “reboot”

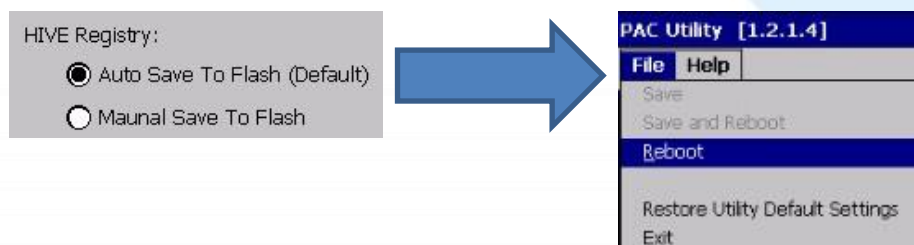

- b. If HIVE Registry is “Manual Save To Flash”, click “Save and Reboot”

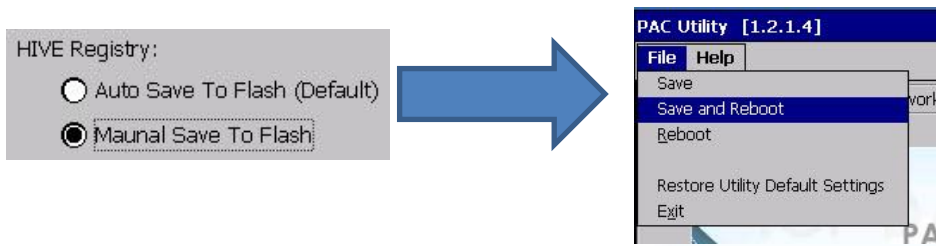

Changing the COM Port

1. Go to “System_Disk\Drivers\Serial_TOUCH\PenMount\BIN” and double click “SetCOM”.

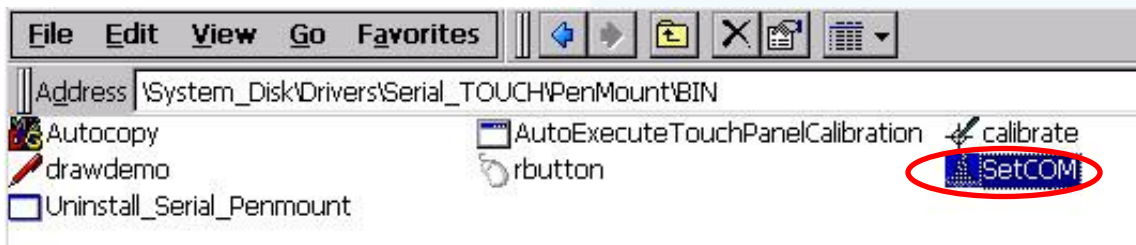

2. In the pop-up dialog, select the COM Port you wish to use as default and click the “Set” button to save the changes.

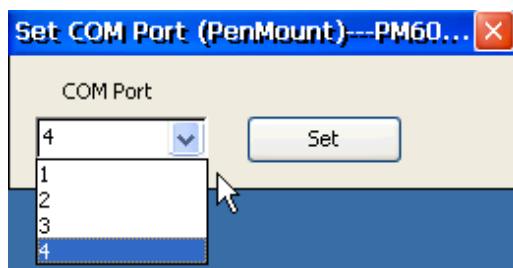

3. From the “Start” menu, click ”Programs”→Open the “WinPAC Utility”
 - a. If HIVE Registry is “Auto Save Flash(Default)”, click “reboot”

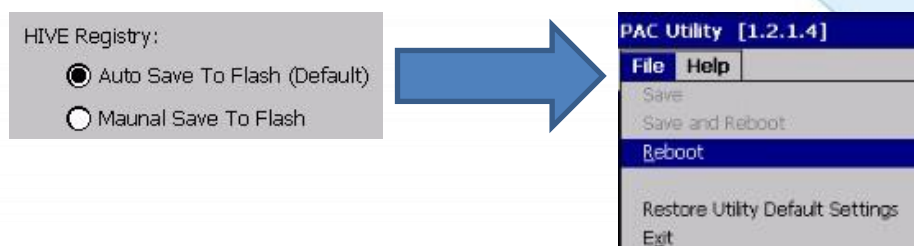

b. If HIVE Registry is “Manual Save To Flash”, click “Save and Reboot”

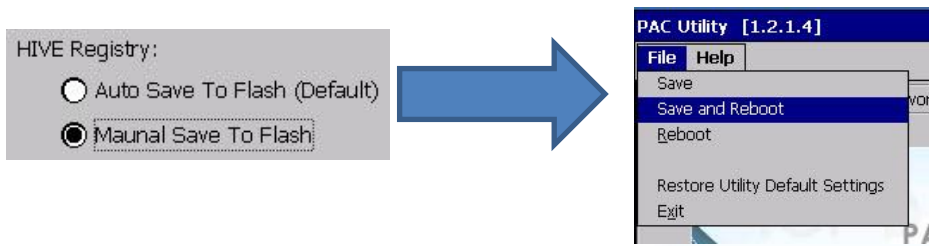

4. Disconnect the cable from the current COM Port and reconnect it to the specified COM Port.

Simulating the Right Mouse Button

1. Go to “System_Disk\Drivers\Serial_TOUCH\PenMount\BIN” and double click “rbutton.exe”.



2. Show a screen below (Left picture) → Click the “mouse” → Turn into right picture.

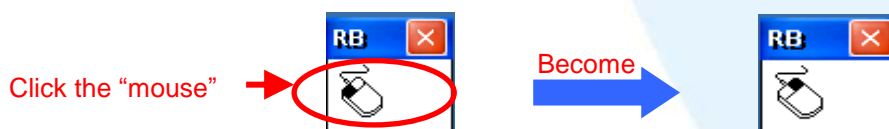

3. **Click any object:** Click “My device” to test if the function of “RightButton” works. If the screen below shows, the function of “RightButton” works.

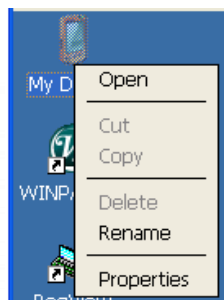

4. The operation of the right mouse button can be simulated by repeating Step 2 and Step 3 for any object.

2.3.2.3. Uninstalling the WinPAC-5000-CE7

The following procedure describes how to uninstall the PenMount serial touch driver.

1. Go to “System_Disk\Drivers\Serial_TOUCH\PenMount\BIN” and double click “Uninstall_Serial_Penmount.exe”



2. A warning pop-up will be displayed asking you to confirm the uninstall request. Click the “Yes” button to uninstall the driver.

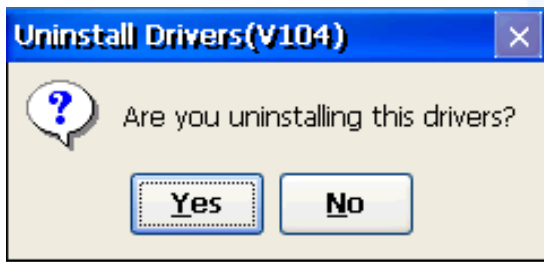

3. Once the uninstallation process is complete, a dialog will be displayed requesting that you reboot the system. Click the “Yes” button to reboot the WinPAC immediately, or click “NO” if you intend to reboot at a later time.



2.3.2.4. Other Windows CE7.0 Devices

The driver for using with other windows CE7.0 devices can be obtained from the PenMount website to download the latest driver. We are use PenMount 6000 chip.

PenMount website: <http://www.salt.com.tw/en>



2.4. Windows XP Embedded

The touch driver for XP embedded is a universal driver. USB and Serial both use the same driver.

2.4.1. Universal Driver

Two universal touch drivers are available. The first is for XP-8000 series modules of ICP DAS PAC controller, and the second is for other Windows XP embedded system.

XP-8000 series:

1. Using ATOM CPU

XP-8141-Atom/XP-8341-Atom/XP-8741-Atom

2. Using LX800 CPU

XP-8041/XP-8341/XP-8741

2.4.1.1. Installation for XP-8000

The following procedure describes how to install the PenMount universal touch driver. There is a **RS-232 cable in the shipping package** (Sec.1). The user can directly use this cable to **connect the monitor with COM5 of XP-8000 to use universal touch driver to do a touch operation by serial way**. If the user wants to use other com port, please note the position of TX and RX of COM port. About the pin assignment, please refer to the user manual of the XP-8000.



1. Copy the driver from the CD-ROM to the XP-8000.

The “PenMount Windows Universal Driver Vx.x.x.x” folder can be obtained from:

[name]	Driver path
TP-2070/TP-3080/	CD:\[name]\Driver\Win_XP_Embedded\XP-8000 device\

TPM-4100_TP-4100/ TP-5120/TP-6150/TP-7170	For example: CD:\TP-2070\Driver\Win_XP_Embedded\XP-8000 device\
--	--

2. Executing XPAC Utility to disable EWF on desktop.

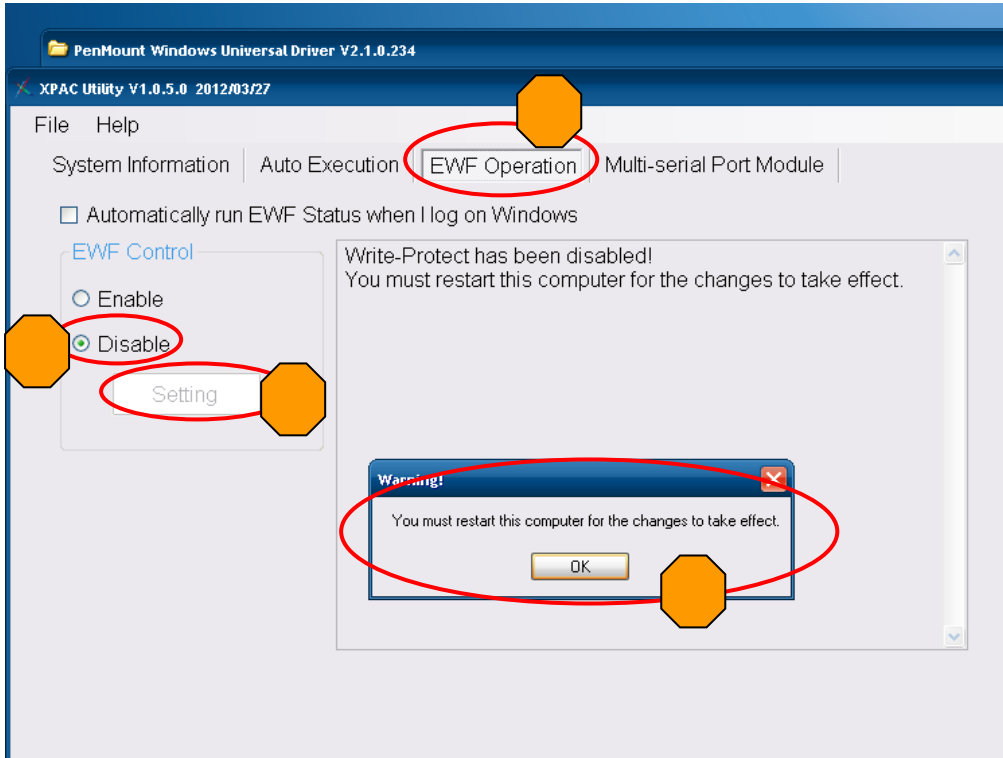

3. Double click Setup.exe in the driver's folder.



4. Click "Next" button to continue installation.

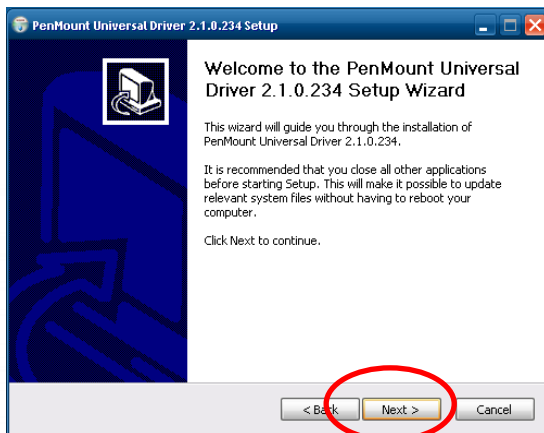

5. Click "I Agree" button.

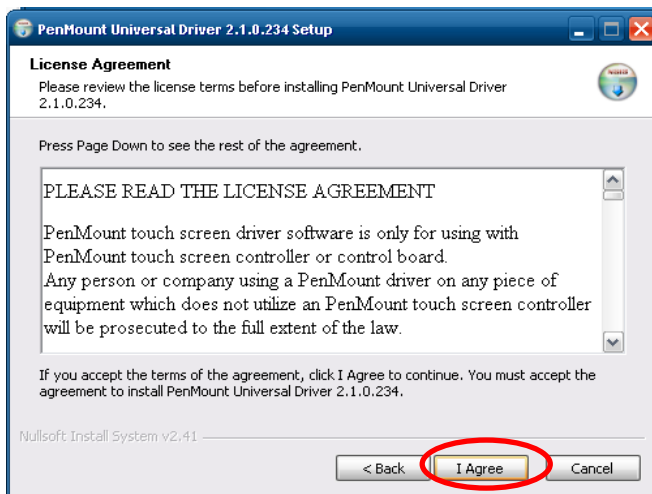

6. Click "Install" button to install driver to destination folder.

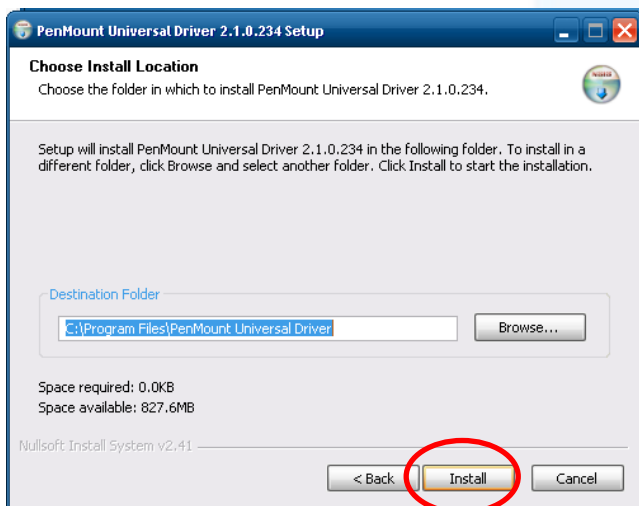

Tips & Warnings



If a screen appears that shows “Found New Hardware Wizard”. Do not use this hardware wizard. Press Cancel.



If a screen appears that shows “Hardware Installation”. Please press “Continue Anyway”.

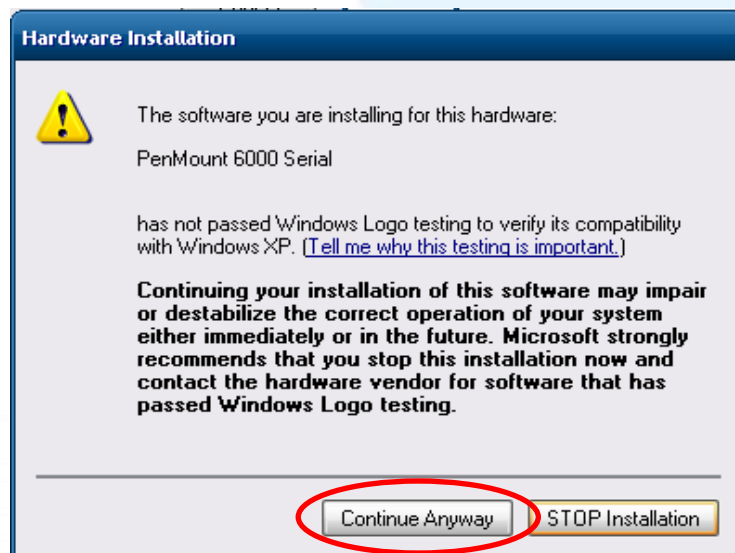

7. Click “Finish” button.

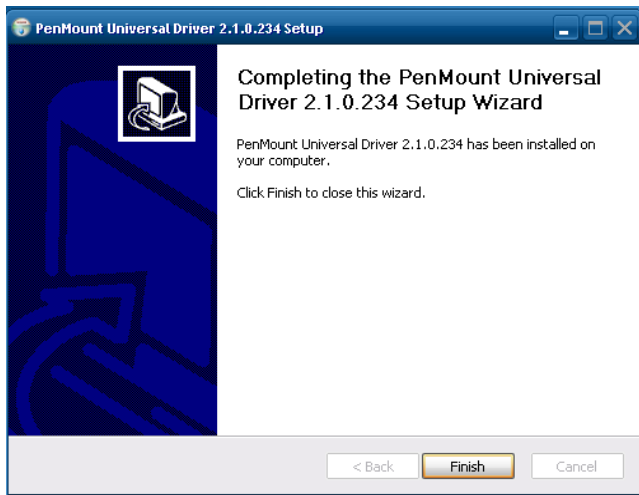

8. Restart XP-8000.
9. Connect USB or serial cable to XP-8000(USB and serial can not be used simultaneously).

If the USB or serial touch doesn't work, please follow the steps below.

- a. From the "Start" menu, click "Programs" → "PenMount Universal Driver" → "PenMount Control Panel".

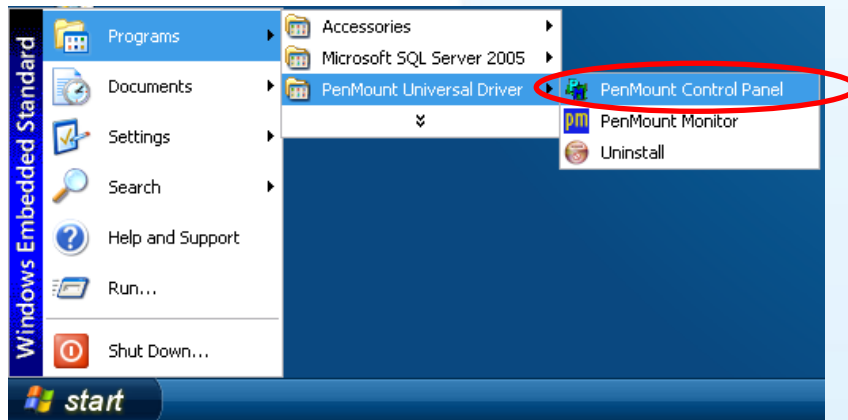

- b. "Device" tab → click "Refresh" button to search USB or serial touch screen monitor → if search is successful, "PenMount 6000 USB" or "PenMount 6000 RS232" will show.

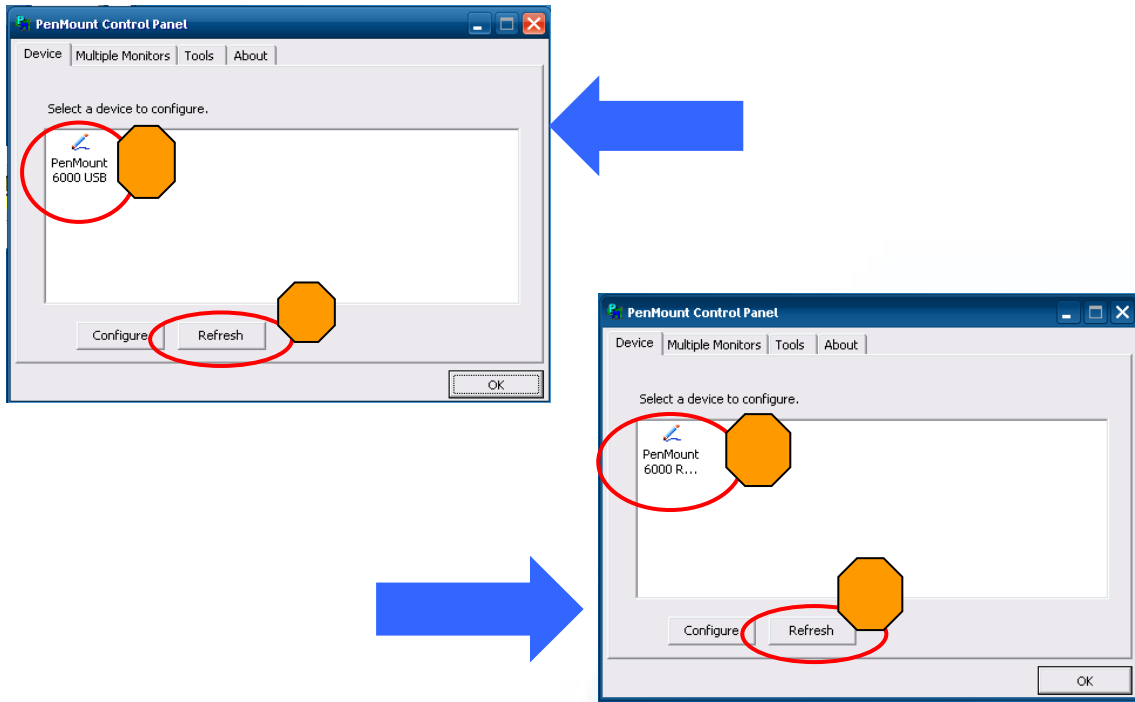

c. If search is successful, USB or serial touch driver has been installed.

10. Executing XPAC Utility to enable EWF on desktop.

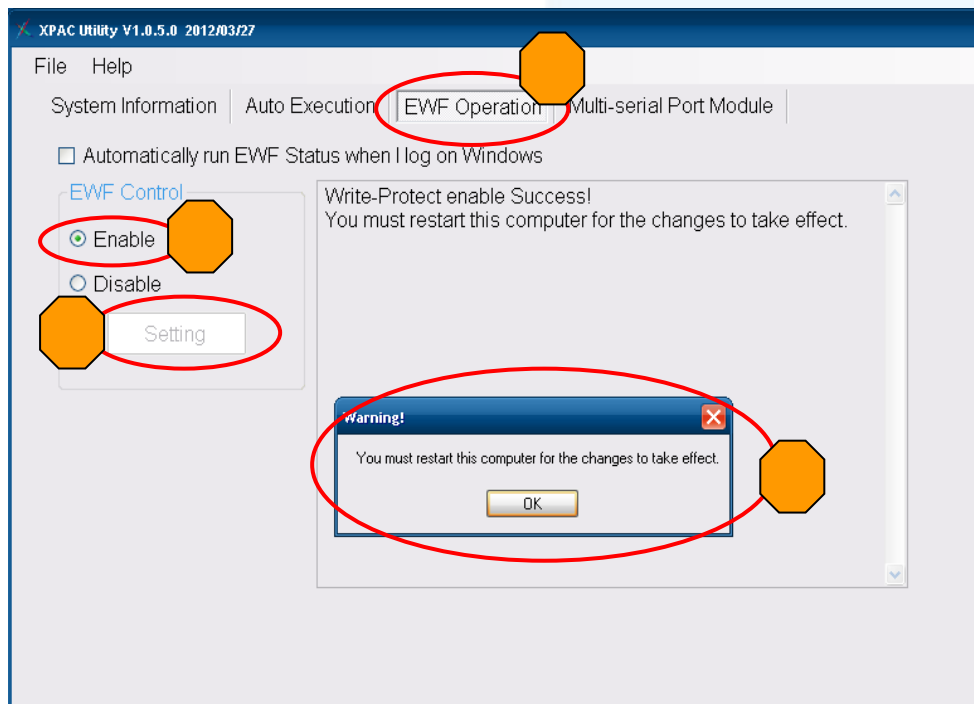

11. Restart XP-8000.

Tips

1. Appendix A → “A.2. Don’t plug USB cable when using serial touch driver”
-

2.4.1.2. Configuration for XP-8000

Calibration

1. From the “Start” menu, click “Programs”→”PenMount Universal Driver”→”PenMount Control Panel”.

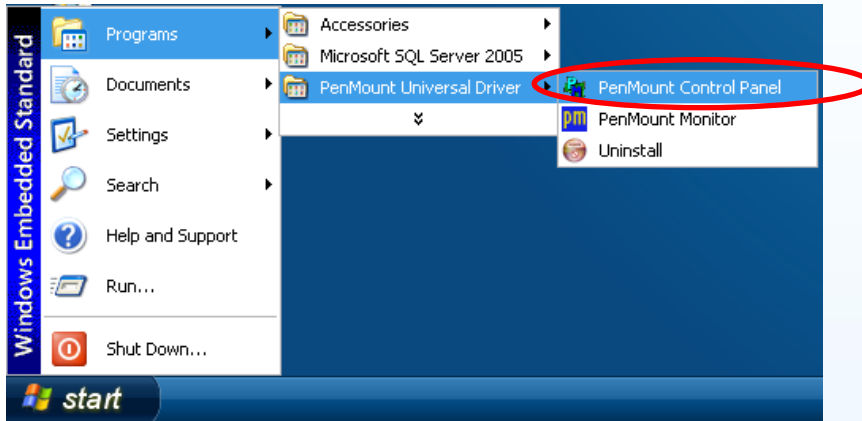

2. Check if the pattern “PenMount 6000 USB” or “PenMount 6000 RS232” shows. If yes, select a device and click “Configure” button. If no, refer to Sec.2.4.1.1.

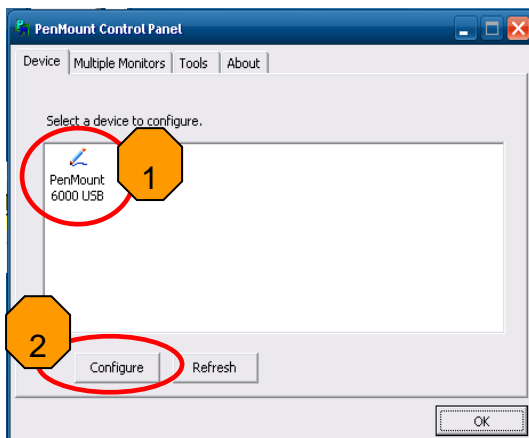

USB touch driver

Or

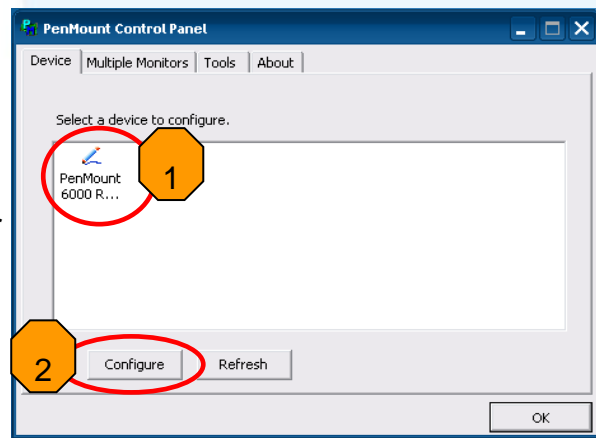

Serial touch driver

3. Click “Standard Calibration” to calibrate.

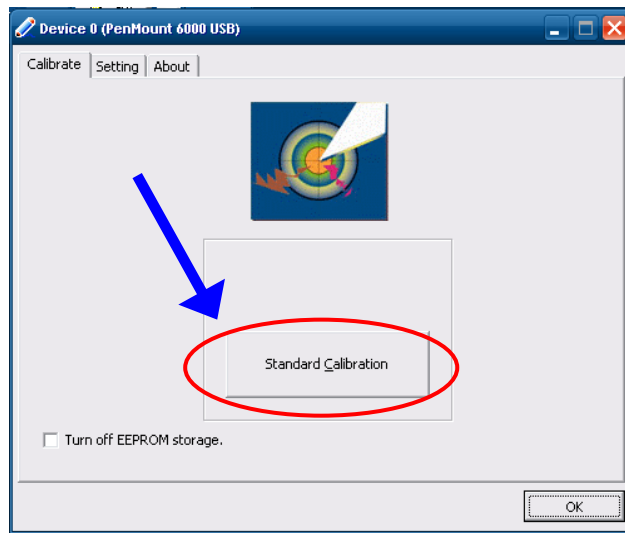

4. Executing XPAC Utility to disable EWF to save setting on desktop.

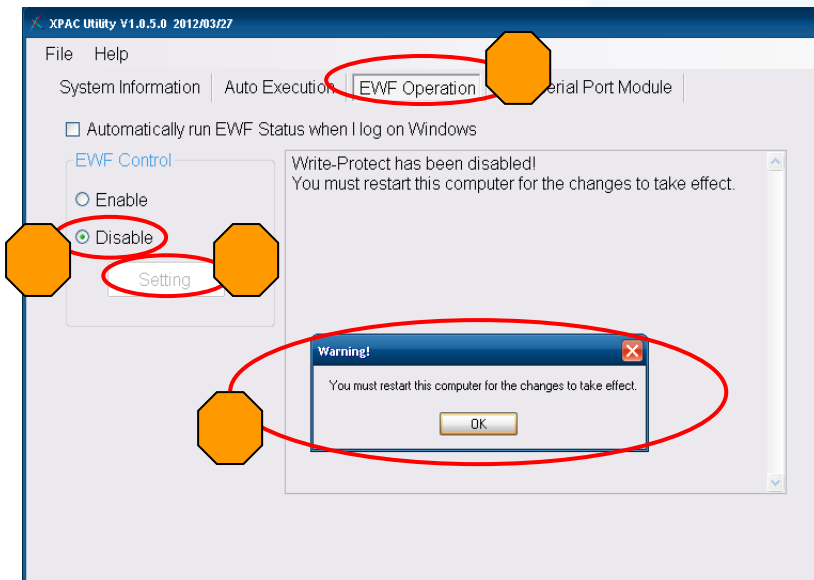

5. Restart XP-8000.
6. Executing XPAC Utility to enable EWF on desktop.

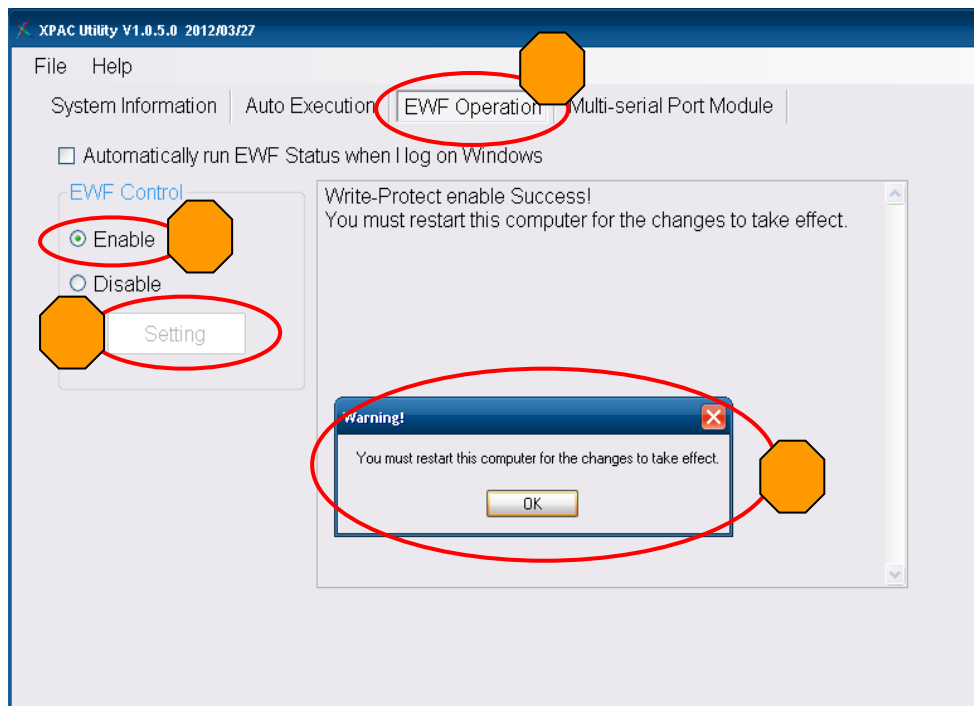

- Restart to XP-8000 for the changes to take effect.

Change the COM Port

For serial touch driver

Method1: The touch driver will detect all com port to find what com port connects to serial touch screen monitor automatically when XP-8000 reboots every time.

Method2: Please refer to the Step 9 of Sec.2.4.1.1 to detect again.

Simulating Right Mouse Button

- From the “Start” menu, click “Programs” → “PenMount Universal Driver” → “PenMount Control Panel”.

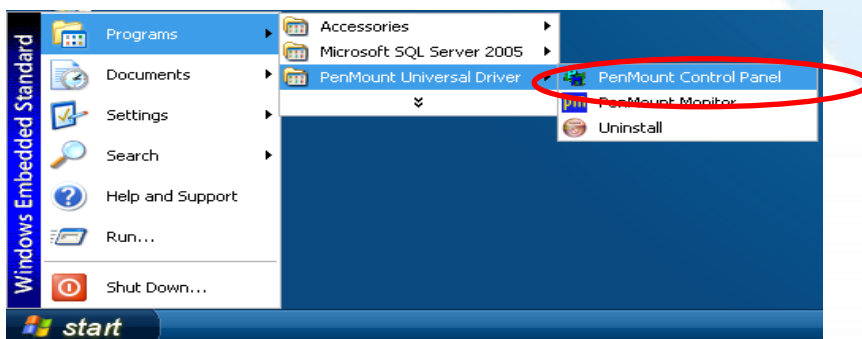

- Click “Right Button Icon”

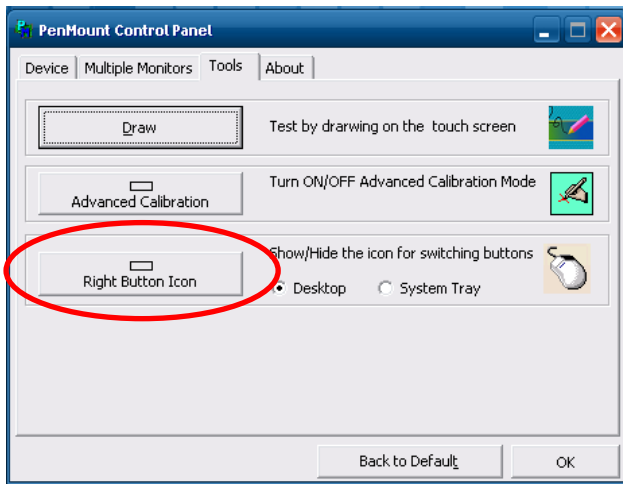

3. Show a screen below (Left picture) → Click the “mouse” → Turn into right picture.



4. **Click any object:** Click “My computer” to test if the “Right Button Icon” function work. If the screen below shows, the “Right Button Icon” function works.

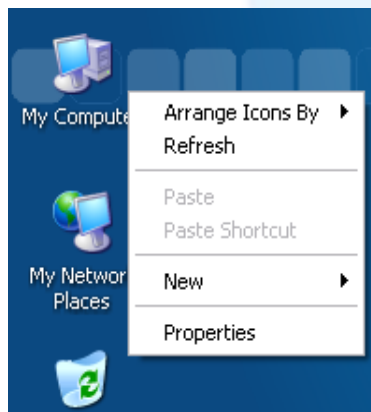

5. You can simulate the operation of right mouse button to repeat step3 and step4 for any object.

2.4.1.3. Uninstall for XP-8000

The following procedure describes how to uninstall the PenMount universal touch driver.

1. Executing XPAC Utility to disable EWF to start to save setting.

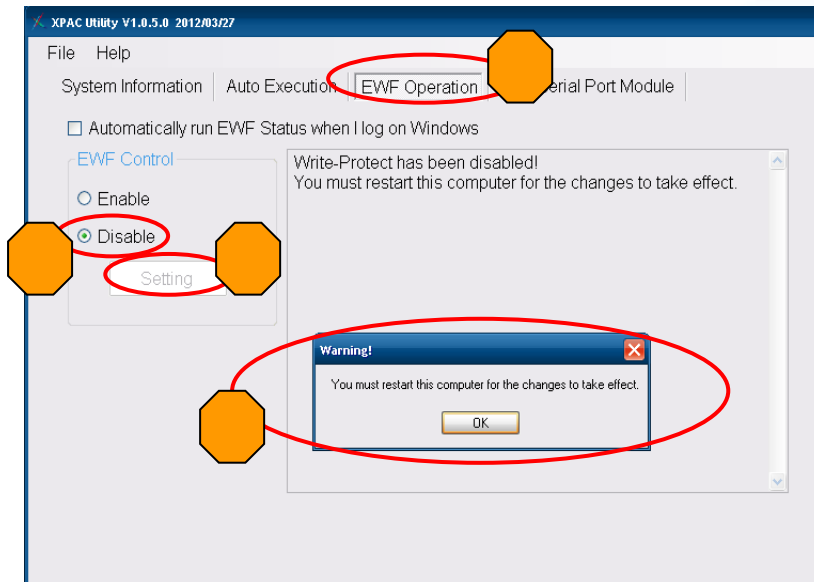

2. From the “Start” menu, click “Programs” → “PenMount Universal Driver” → “Uninstall”.

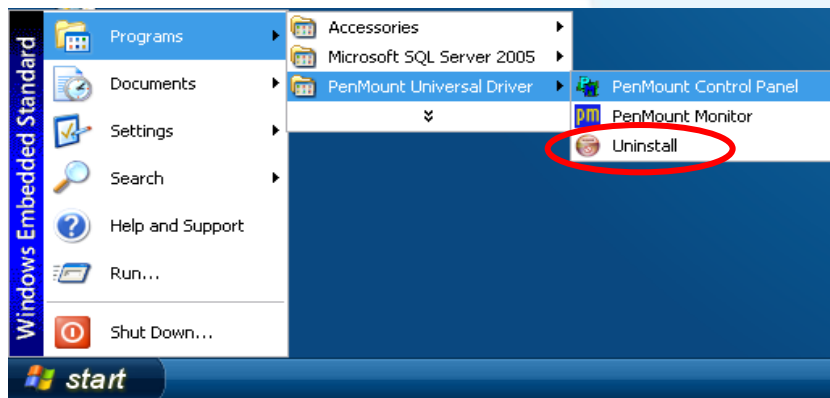

3. Click “Yes” button.

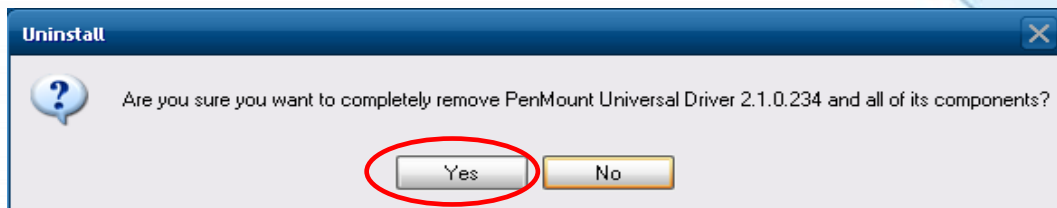

4. Click “Yes” button to reboot.

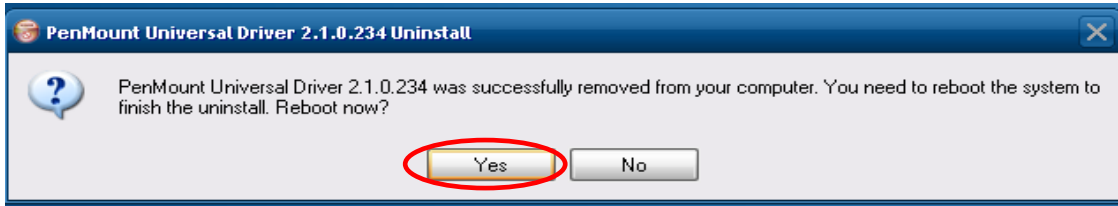

5. After reboot, executing XPAC Utility to enable EWF on desktop.

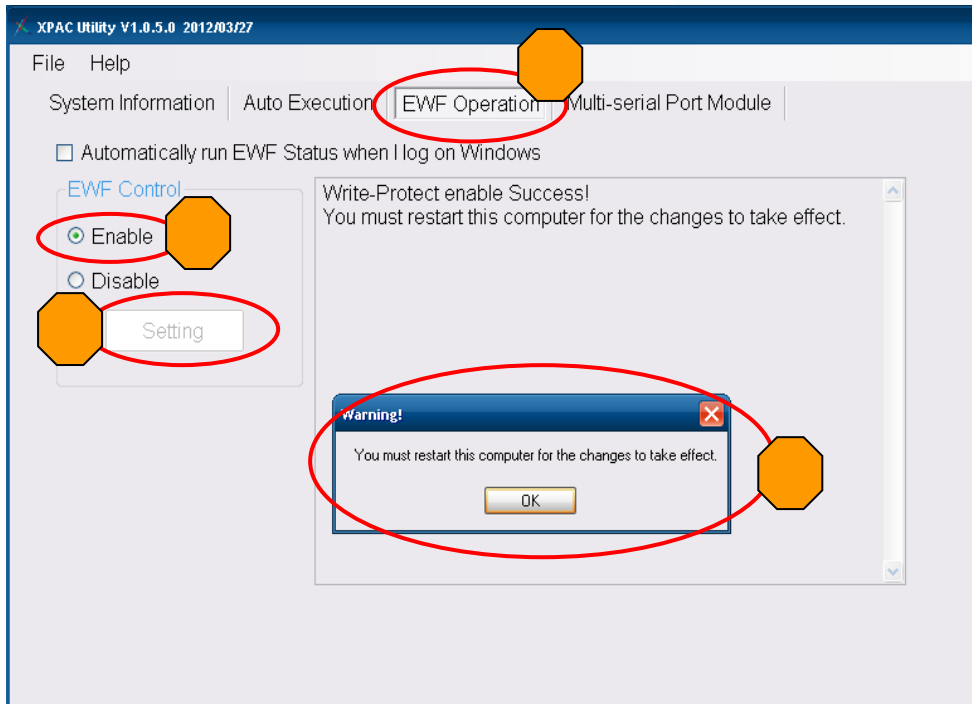

6. Restart XP-8000.

2.4.1.4. Other Windows XP Embedded Devices

The driver for using with other windows XP Embedded devices can be obtained from the PenMount website to download the latest driver. We are use PenMount 6000 chip.

PenMount website: <http://www.salt.com.tw/en>



2.5. Windows XP/7

The touch driver for 2k/XP/2003/2008/Vista/7 is a universal driver. USB and Serial both use the same driver.

2.5.1. Universal Driver

This section describes how to install, calibrate and uninstall the universal driver for 2k/XP/2003/2008/Vista/7.

2.5.1.1. Installation

The following procedure describes how to install the PenMount universal touch driver.

1. Copy the driver from the CD-ROM to your device.

The touch driver can be obtained from:

[name]	Driver path
TP-2070/TP-3080	CD:[name]\Driver\Win_XP_7\
TPM-4100_TP-4100/	For example:
TP-5120/TP-6150//TP-7170	CD:\TP-2070\Driver\Win_XP_7\

2. Connect USB or serial cable to your device (USB and serial can not be used simultaneously).
3. Executing Setup.exe.
4. Click “Next” button to continue installation.

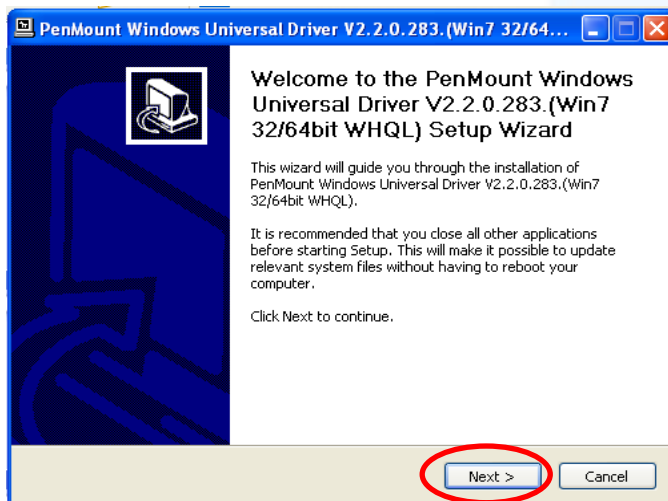

5. Click “I Agree” button.

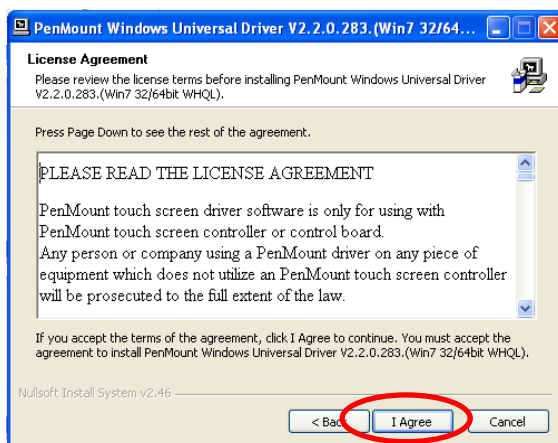

6. Click “Install” button to install driver.

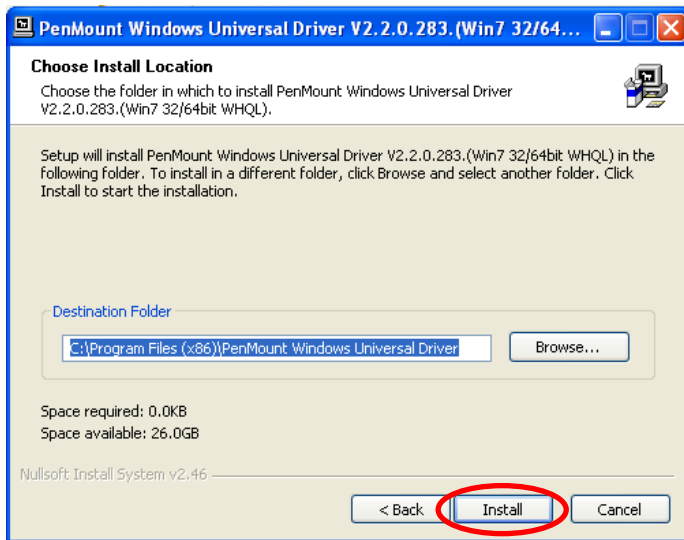

7. Click “Finish” to finish installation.

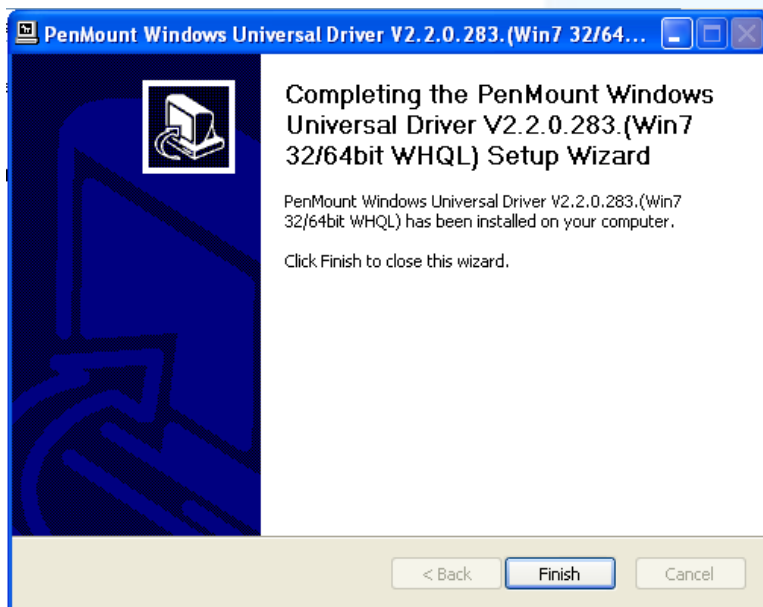

Tips & Warnings



When the system first detects a touch monitor, a screen appears that shows “Unknown Device”. Do not use this hardware wizard. Press Cancel.



8. If the USB or serial touch doesn't work, following the steps below:
 - a. From the “Start” menu, click “All Programs”→”PenMount Windows Universal Driver”→”Utility”→”PenMount Control Panel”.

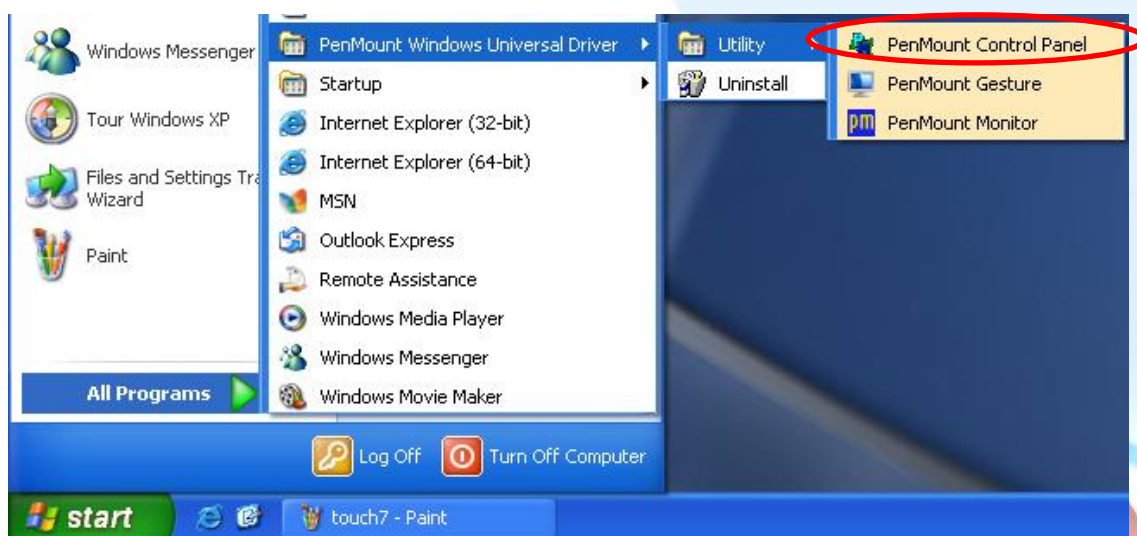

- b. "Device" tab → click "Refresh" button to search USB or serial touch screen monitor → if search is successful, "PenMount 6000 USB" or "PenMount 6000 RS232" will show.

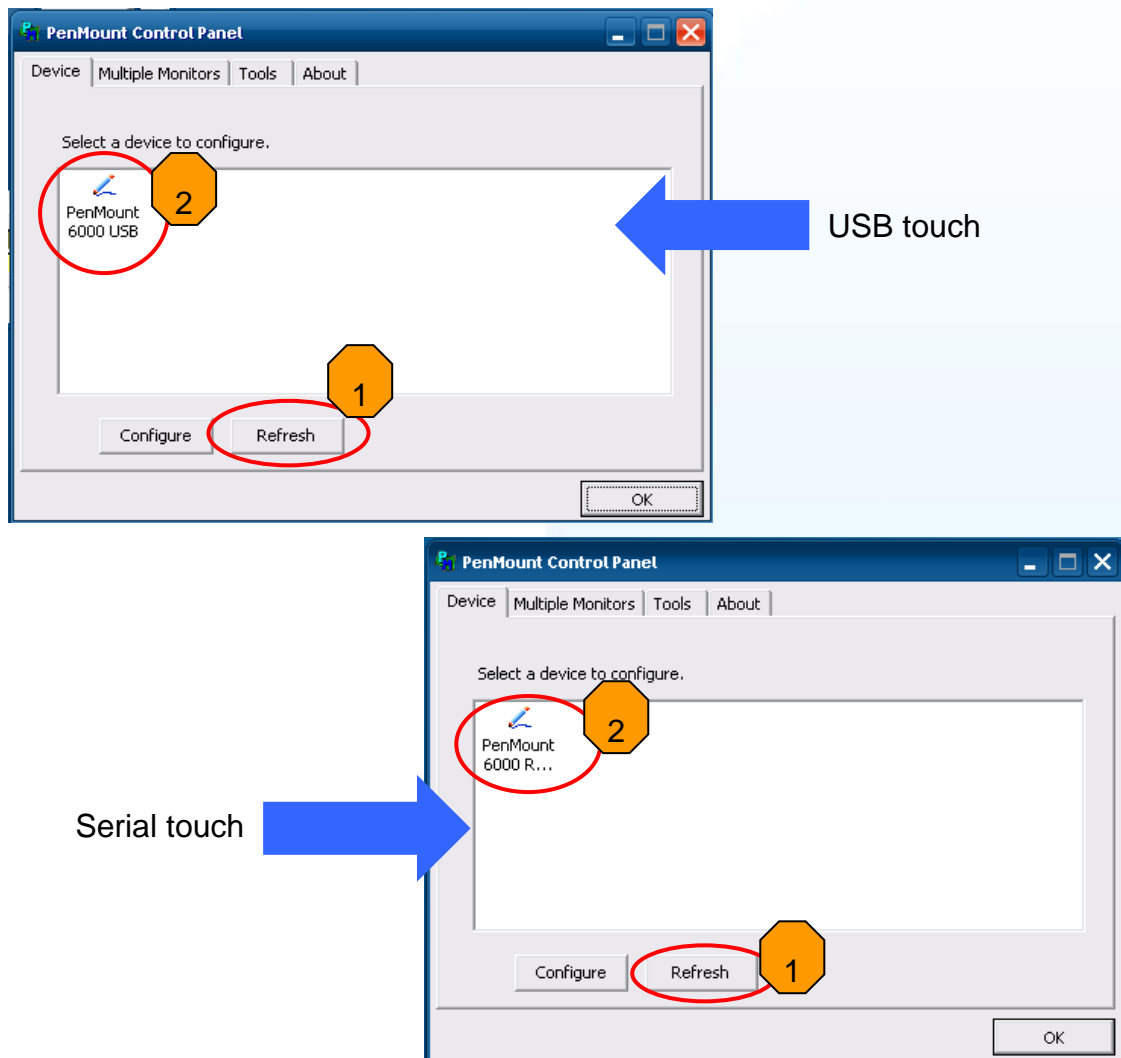

- c. If search is successful, the USB or serial touch driver has been installed.

Tips

1. Appendix A → “A.2. Don’t plug USB cable when using serial touch driver”
-

2.5.1.2. Configuring

Calibration

1. From the “Start” menu, click “All Programs”→”PenMount Windows Universal Driver”→”Utility”→”PenMount Control Panel”.

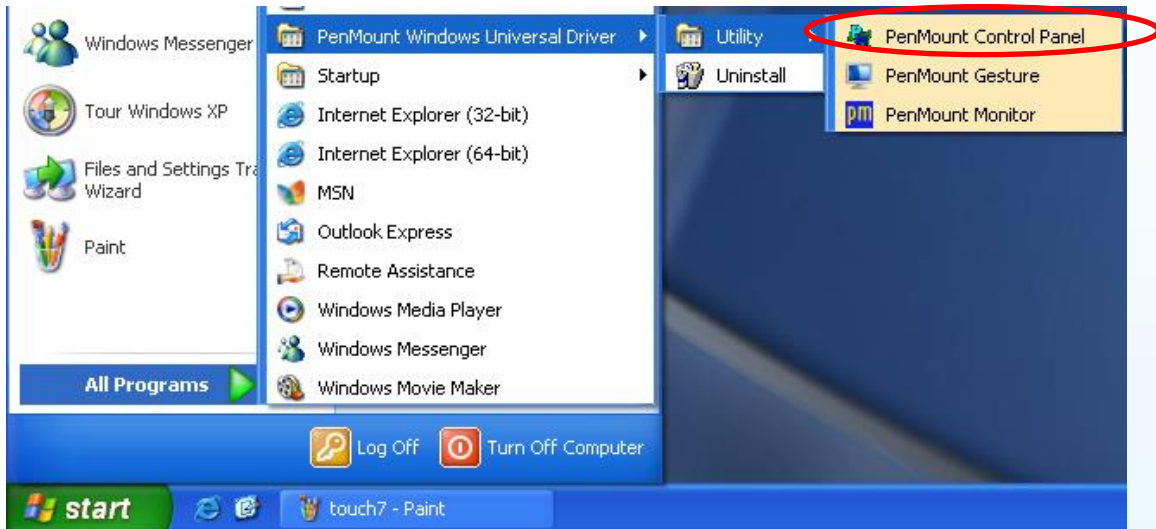

2. Check if the pattern “PenMount 6000 USB” or “PenMount 6000 RS232” shows. If yes, select a device and click “Configure” button. If no, refer to Sec.2.5.1.1.

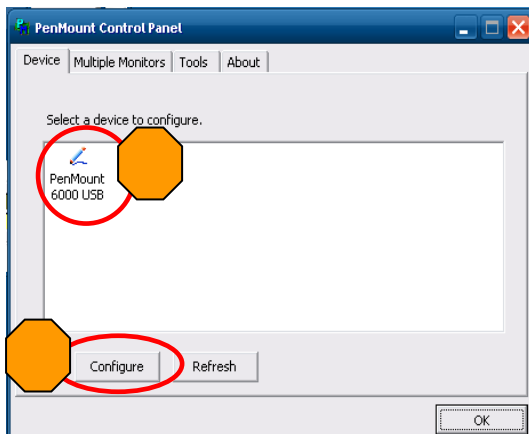

USB touch driver

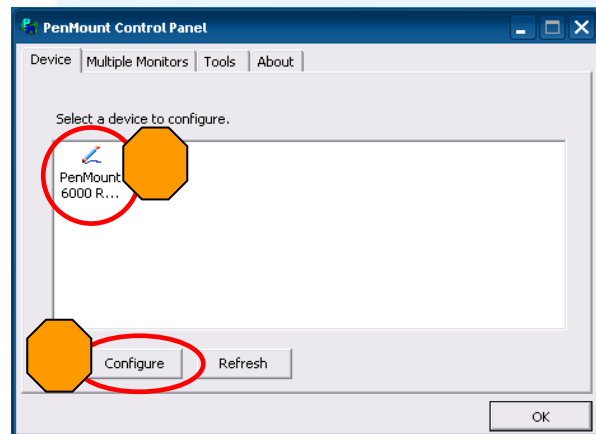

Serial touch driver

3. Click “Standard Calibration” to calibrate.

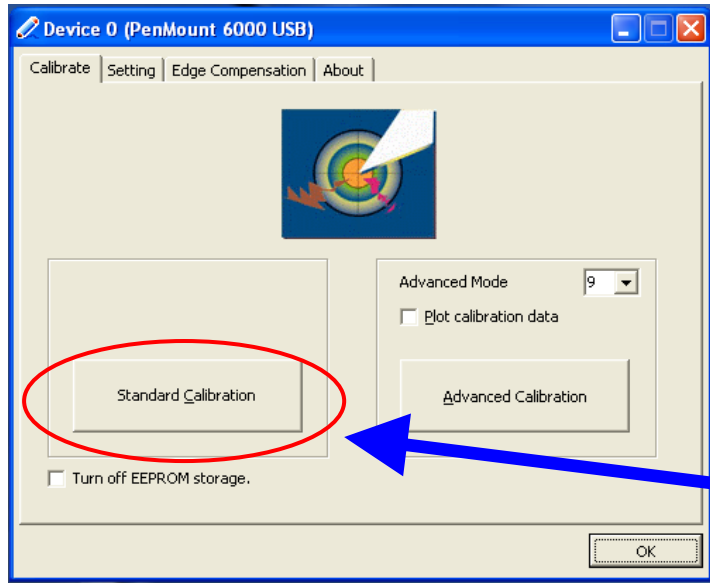

Change the COM Port

For serial touch driver

Method1: The touch driver will detect all com port to find what com port connects to serial touch screen monitor automatically when PC reboots every time.

Method2: Please refer to the Step 8 of Sec.2.5.1.1 to detect again.

Simulating Right Mouse Button

For details of how to configure right mouse button simulation, please refer to the process describes in “Simulating the Right Mouse Button” in [Sec.2.4.1.2](#).

2.5.1.3. Uninstall

The following procedure describes how to uninstall the PenMount universal touch driver.

1. **XP:** Start → All Programs → PenMount Windows Universal Driver → Uninstall.
Win7: Control Panel → Programs → Programs and Features

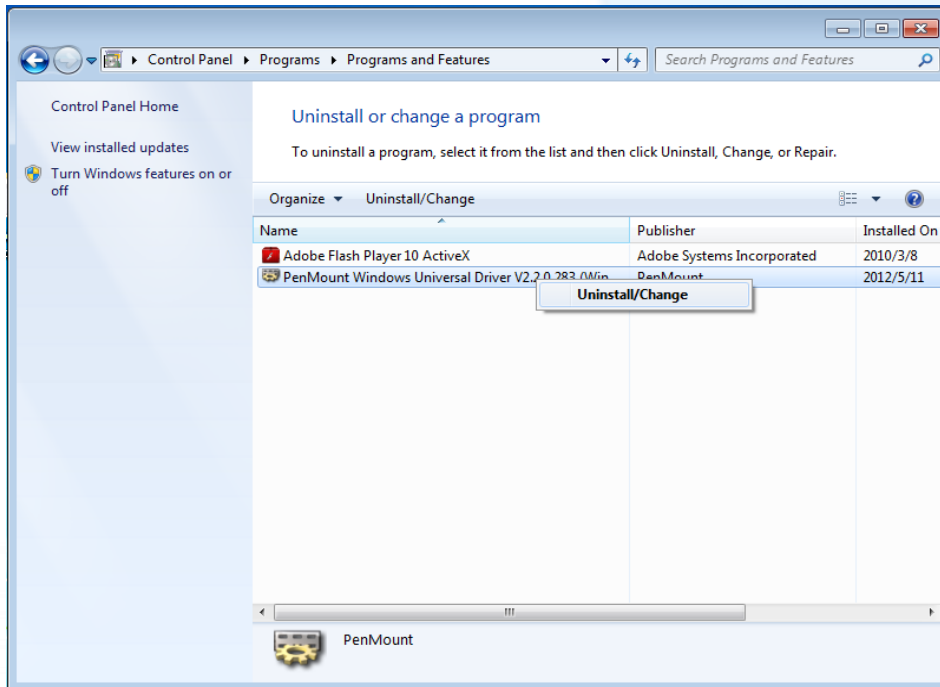
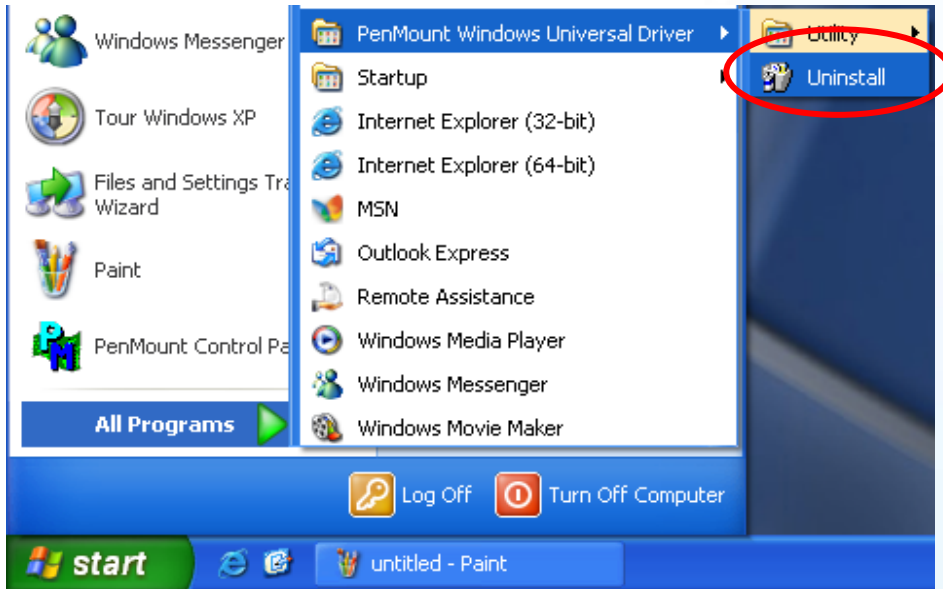

2. Click "Next" button.

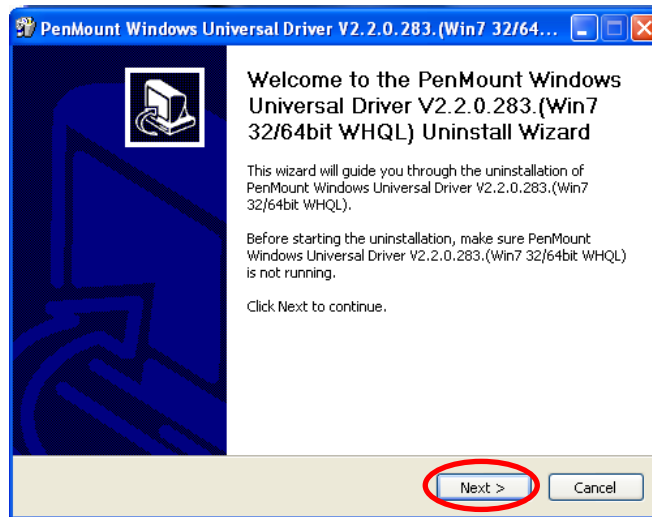

3. Click “Uninstall” button.

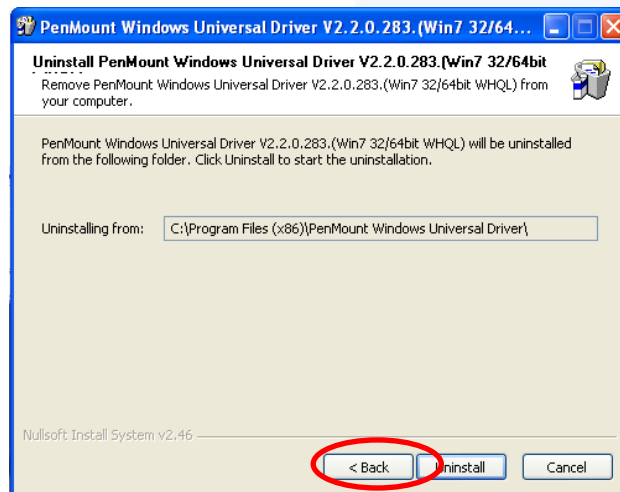

4. Click “Finish” button to reboot.

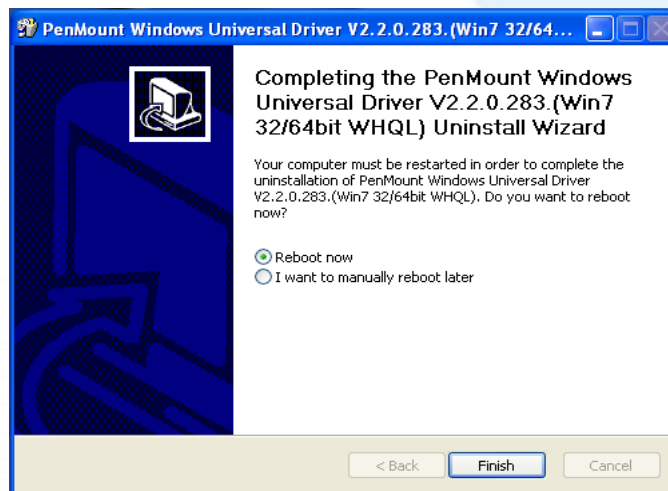

Appendix A. Tips

A.1. Don't install USB and serial touch driver simultaneously in a device

Platform: WP-8000/WP-5000/XP-8000-CE6 series controller

If USB and serial touch drivers are installed at the same time in a device, USB and serial touch drivers will conflict.

Please install only one touch driver in a device every time.

We suggest this installation below



Please don't do this installation below



A.2. Don't plug USB cable when using serial touch driver

Platform: WP-8000/WP-5000/XP-8000-CE6 series controller

Problem: Only serial touch driver is installed but both USB and RS-232 cables are plugged.

Effect: RS-232 touch can't work normally.

Reason: The OS uses wrong USB driver and the driver conflicts with serial touch driver. There are still other USB drivers in OS although USB touch driver is not installed.

Solution: Remove USB cable and restart the device.

Platform: XP-8000 series controller/windows XP/2008/7 PC

Problem: Both USB and RS-232 cables are plugged.

Effect: Only USB touch can work or the touch operation works incorrectly.

Reason: The touch driver only handles one touch interface every time. If it finds two touch interfaces, it will confuse.

Solution: Remove USB cable → Restart the device or research touch interface.

Please plug only RS-232 cable.



Appendix B. Revision History

Revision	Date	Description
1.0.2	August 2012	First release
1.0.3	September 2013	<ol style="list-style-type: none"> 1. Modify specifications about TP-4100/TPM-4100 2. Modify the name of serial driver for WinPAC-8000 and WinPAC-5000 3. Add “Tips & Warnings” to Step6 in Sec.2.4.1.1
1.0.4	September 2013	Add related description of “TP-3070”
1.0.5	October 2013	Add related description of “TP-6150/TPM-6150”
1.0.6	December 2013	Modify the model name: TP-3070 to TP-2070
1.0.7	June 2014	<ol style="list-style-type: none"> 1. Delete related description of TPM-6150 2. Add related description of TP-3080/TP-5120/TP-7170 3. There are two kinds of OSD menu. TP-4100/TPM-4100/TP-2070 use the same OSD menu. TP-3080/TP-5120/TP-6150/TP-7170 use the other one. 4. The OS version 1710 and upward of WP-8x4x supports resolution 640X480 for TP-2070. The OS version 1300 and upward of WP-5x4x supports resolution 640X480 for TP-2070. 5. TP-6150 cancels the power switch. The function is moved to OSD menu.

1.0.8	July 2014	Add "A.1" and "A.2" of Appendix A
1.0.9	January 2015	Modify LED characters. "Data" to "RUN". "Power" to "PWR". See the section 1.6.1 "System Configuration"
1.1.0	April 2015	<ol style="list-style-type: none"> 1. Add "weight" specification for TP-4100/TPM-4100 2. Add new Section 2.3 Windows CE 7.0 3. Modify Sec.2.1.1.4/2.1.2.4/2.2.1.4/2.2.2.4/2.4.1.4.