CANopen Slave Device

CAN-2024C

Application User's Manual

Warranty

Without contrived damage, all products manufactured by ICP DAS are warranted in one year from the date of delivery to customers.

Warning

ICP DAS revises the manual at any time without notice. However, no responsibility is taken by ICP DAS unless infringement act imperils to patents of the third parties.

Copyright

Copyright © 2009 is reserved by ICP DAS.

Trademark

The brand name ICP DAS as a trademark is registered, and can be used by other authorized companies.

Contents

1	Introduction.....	3
1.1	Overview.....	3
1.2	Hardware Specifications	4
1.3	Features.....	5
1.4	Application	5
2	Hardware	6
2.1	Structure.....	6
2.2	Node ID & Baud Rate Rotary Switch	7
2.3	LED Description.....	8
2.4	PIN Assignment	9
2.5	Wire Connection	10
3	Object Dictionary.....	11
3.1	Object List.....	11
3.2	Store and Restore Object.....	14
3.3	Application Object.....	15
3.4	Default PDO Mapping.....	19

1 Introduction

1.1 Overview

CANopen is one kind of the network protocols based on the CAN bus and mainly used for embedded network system, such as industrial machine control, vehicle control system, factory automation, medical equipments control, remote data acquisition, environmental monitoring, and packaging machines control, etc.

The CAN-2024C module follows the CiA DS-301 version 4.02 and DSP-401 version 2.1. It is easy to access the analogue I/O status and set the configuration by using the standard CANopen protocol. The CAN-2024C has passed the validation of the CiA CANopen Conformance Test tool. Therefore, the provided EDS file is standard for any other standard CANopen masters. Owing to the 4-channel analog output and the CANopen masters of ICP DAS, you can quickly build a CANopen network to approach your requirements.



Figure 1-1

1.2 Hardware Specifications

Analogue Output:

- Output Channels: 4 single-end channels
- Output Type : 0 ~ +20 mA, 4 ~ +20 mA, 0 ~ +5 VDC, -5 VDC ~ +5 VDC, 0 ~ +10 VDC, -10 VDC ~ +10 VDC.
- Resolution : 14-bit.
- Accuracy: +/- 0.1% of FSR for Voltage Output.
+/- 0.2% of FSR for Current Output.
- Zero Drift :Voltage: +/- 30 μ V/ °C.
Current: +/-0.2 μ A/ °C.
- Span Drift : +/- 20ppm/ °C.
- Voltage Output Capability: 10V@5mA.
- Max Current Load Resistance: external power +24 V:1050 Ω .
- Power-on Value & Safe value: Yes.
- 4KV ESD Protection: Yes, Contact for each terminal.
- Intra-module Isolation, Field to Logic: 3000 VDC.
-

Others:

- CANopen Status: 3 LEDs for PWR / RUN / ERR.
- Terminator Resister: Yes, by DIP-switch with 1 LED indicator
- AO LED: 4 LEDs for analog output, and 4 LEDs for circuit output
- Power Supply: Unregulated +10 ~ +30 VDC.
- Power Consumption: 1.5 W.
- Operating Temperature: -25 ~ 75 °C.
- Storage Temperature: -40 ~ 80 °C.
- Humidity: 5 to 95% RH, Non-condensing.
- Dimensions: 32.5 mm x 110 mm x 102 mm (W x L x H) Detail.

1.3 Features

- Standard CANopen general I/O slave devices.
- CANopen Version: DS-301, v4.02.
- Device Profile: DSP-401, v2.1
- Provide 4 single-end analog output channels.
- CANopen transfer rate: 10 kbps, 20 kbps, 50 kbps, 125 kbps, 250 kbps, 500 kbps, 800 kbps, 1000 kbps.
- Maximum CANopen slave Node-ID up to 99.
- Support NMT, PDO, SDO, EMCY, SYNC, Guarding, and Heartbeat protocol.
- Pass the validation of CANopen conformance test
- Provide EDS file for CANopen master interface

1.4 Application

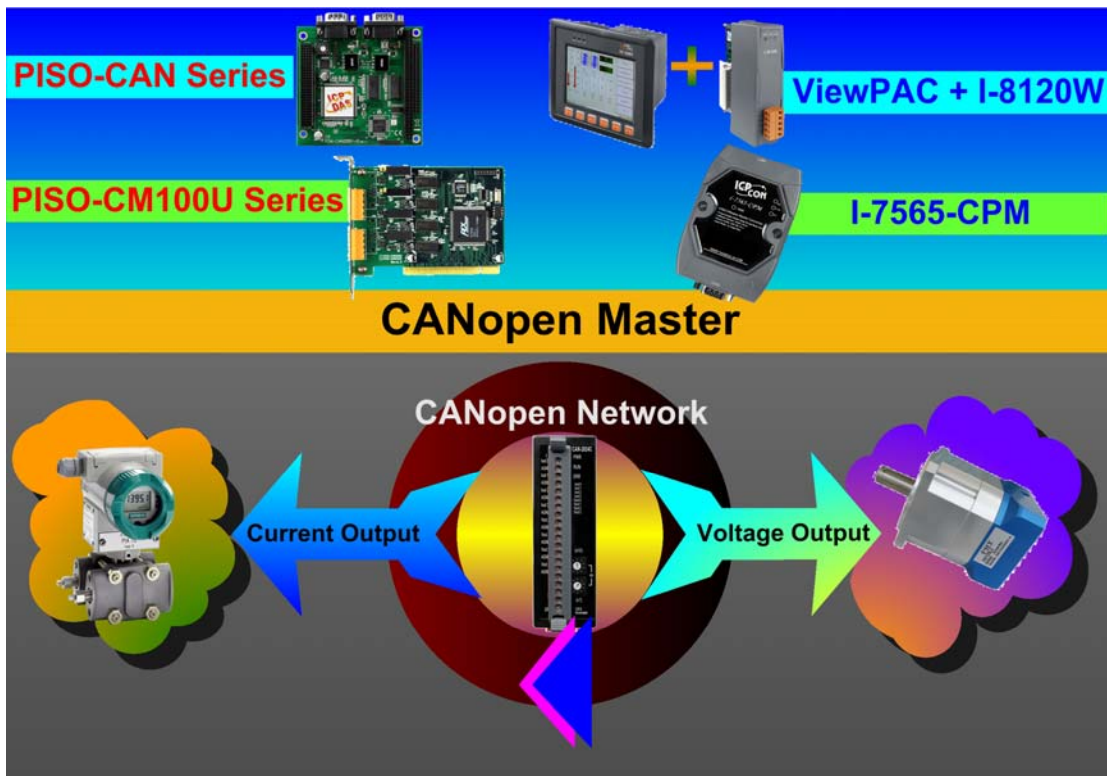

Figure 1-2 Application Structure

2 Hardware

2.1 Structure

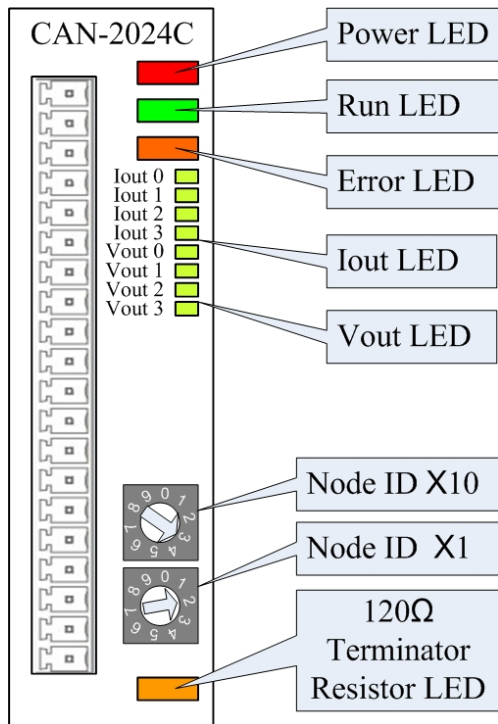

Figure 2-1 (Top View)

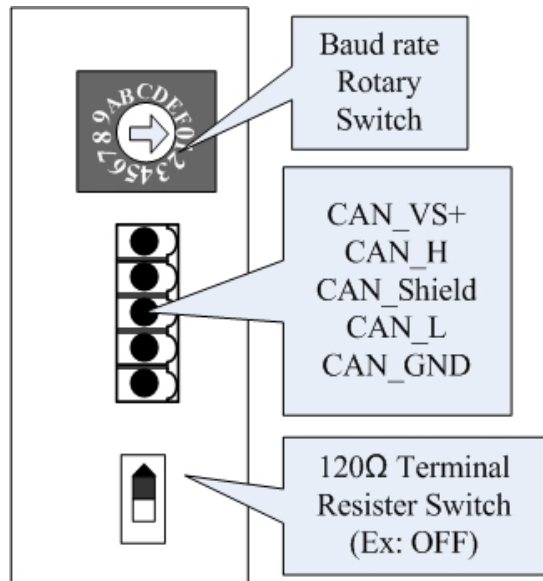

Figure 2-2 (Bottom View)

2.2 Node ID & Baud Rate Rotary Switch

The rotary switches of node ID configure the node ID of CAN-2024C module. These two switches are for the tens digit and the units digit of the node ID. The node ID value of this demo picture is 32.

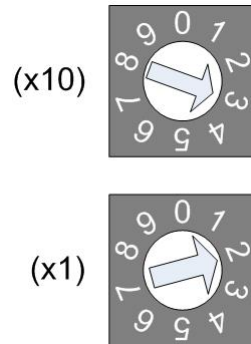

Figure 2-3 Node ID rotary switch

The rotary switch of baud rate handles the CAN baud rate of CAN-2024C module. The value of baud rate switch from 0 ~ 7 are normal CANopen mode, The relationship between the rotary switch value and the practical baud rate is presented in the following table.

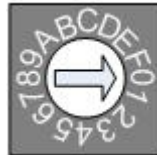

Figure 2-4 Baud rate rotary switch

Rotary Switch Value	Baud Rate (k bps)
0	10
1	20
2	50
3	125
4	250
5	500
6	800
7	1000

Table 2-1

2.3 LED Description

Power LED

CAN-2024C allows 10 VDC ~ 30 VDC for working voltage. The power consumption is 1.5 W. Under the connection of a proper power connection, as the unit is turned on, the LED will light up in red.

Run LED

The Run LED indicates the CANopen operation state. The description of LED state is shown below. About the detail, please refer to the section 2.3.1 of the CAN-2000C user manual.

LED Signal	State	Description
No Light	Non-operation	Power Supply is not ready
Single Flash	Stopped	The device is in Stopped state
Blinking	Pre-operational	Device is in Pre-operational state
Continuing Light	Operational	Device is in Operational state

Table 2-2

Error LED

The Error LED indicates the CANopen error state. The description of LED state is shown below. About the detail please refer to the section 2.3.2 of the CAN-2000C user manual.

LED Signal	State	Description
No Light	No error	Device is working well.
Single Flash	Error Warning	At least one CANopen error happened.
Double Flash	Guarding Fail	Guarding fail event happened.
Continuing Light	Bus Off	The bus off state happened.

Table 2-3

Terminal Resistor LED

When enable the 120Ω terminator resistor, the LED will turn on.

Vout LED

If the CAN-2024C is applied in voltage mode, the Vout LED is turned on while the corresponding channel outputs a non-zero voltage value.

Iout LED

If the CAN-2024C is applied in current mode, the Iout LED is turned on while the corresponding channel outputs a non-zero current value.

2.4 PIN Assignment





















Terminal No.	Pin Assignment
 01	Iout 0
 02	AGND
 03	Iout 1
 04	AGND
 05	Iout 2
 06	AGND
 07	Iout 3
 08	AGND
 09	Vout 0
 10	AGND
 11	Vout 1
 12	AGND
 13	Vout 2
 14	AGND
 15	Vout 3
 16	AGND
 17	N/A
 18	N/A
 19	N/A
 20	N/A

Figure 2-7

2.5 Wire Connection

Current Output Wiring

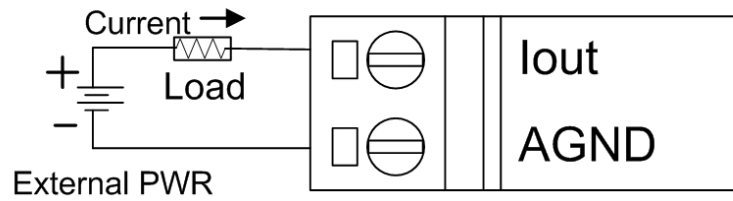

Voltage Output Wiring

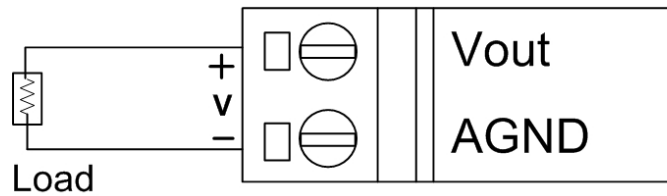

Figure 2-8

3 Object Dictionary

3.1 Object List

General Communication Entries

Idx	Sidx	Description	Type	Attr	Default
1000h	0h	device type	UNSIGNED 32	RO	00300191h
1001h	0h	error register	UNSIGNED 8	RO	0h
1003h	0h	largest sub-index supported for "predefine error field"	UNSIGNED 8	RO	0h
	1h	actual error (the newest one)	UNSIGNED 32	RO	---
	---
	5h	actual error (the oldest one)	UNSIGNED 32	RO	---
1005h	0h	COB-ID of Sync message	UNSIGNED 32	RW	80h
1008h	0h	manufacturer device name	VISIBLE_STRING	RO	CAN-2024C
1009h	0h	manufacturer hardware version	VISIBLE_STRING	RO	02
100Ah	0h	manufacturer software version	VISIBLE_STRING	RO	1.00-20100201
100Ch	0h	guard time	UNSIGNED 16	RW	0h
100Dh	0h	life time factor	UNSIGNED 8	RW	0h
1010h	0h	largest sub-index supported for "store parameters"	UNSIGNED 8	RO	1h
1010h	1h	save all hardware parameter	UNSIGNED 32	RW	---
1011h	0h	largest sub-index supported for "restore default parameters"	UNSIGNED 8	RO	1h
1011h	1h	restore all default parameters	UNSIGNED 32	RW	---
1014h	0h	COB-ID of EMCY	UNSIGNED 32	RW	80h+x
1017h	0h	producer heartbeat time	UNSIGNED 16	RW	0
1018h	0h	largest sub-index supported for "identity object"	UNSIGNED 8	RO	4
	1h	vender ID	UNSIGNED 32	RO	0x0000013C
	2h	product code	UNSIGNED 32	RO	0x00002024
	3h	revision number	UNSIGNED 32	RO	0x00010001
	4h	serial number	UNSIGNED 32	RO	0x6cd3683c

Table 3-1

Note: x is Node-ID of the module

SDO Communication Entries

Idx	Sidx	Description	Type	Attr	Default
1200h	0h	largest sub-index supported for “server SDO parameter”	UNSIGNED 8	RO	2
	1h	COB-ID form client to server (RxSDO)	UNSIGNED 32	RO	600h+x
	2h	COB-ID form server to client (TxSDO)	UNSIGNED 32	RO	580h+x

Table 3-2

Note: x is Node-ID of the module

RxPDO Communication Entry

Idx	Sidx	Description	Type	Attr	Default
1401h	0h	Number of entries	UNSIGNED 8	RO	4
	1h	COB-ID used by RxPDO	UNSIGNED 32	RW	300h+x
	2h	Transmission type	UNSIGNED 8	RW	FFh

Table 3-3

Note: x is Node-ID of the module

RxPDO Mapping Communication Entry

Idx	Sidx	Description	Type	Attr	Default
1601h	0h	Number of entries	UNSIGNED 8	RW	4
	1h	Write AO channel 0	UNSIGNED 16	RW	6411 0110h
	2h	Write AO channel 1	UNSIGNED 16	RW	6411 0210h
	3h	Write AO channel 2	UNSIGNED 16	RW	6411 0310h
	4h	Write AO channel 3	UNSIGNED 16	RW	6411 0410h

Table 3-4

Analogue Output Function

Idx	Sidx	Description	Type	Attr	Default
6411h	0h	Number of Output 8-Bit	UNSIGNED 16	RO	1
	1h	AO value of channel 0	UNSIGNED 16	RW	0
	2h	AO value of channel 1	UNSIGNED 16	RW	0
	3h	AO value of channel 2	UNSIGNED 16	RW	0
	4h	AO value of channel 3	UNSIGNED 16	RW	0
6443h	0h	Number of Analogue Outputs	UNSIGNED 8	RO	1
	1h	Error Mode AO channel 0	UNSIGNED 8	RW	0
	2h	Error Mode AO channel 1	UNSIGNED 8	RW	0

	3h	Error Mode AO channel 2	UNSIGNED 8	RW	0
	4h	Error Mode AO channel 3	UNSIGNED 8	RW	0
6444h	0h	Number of Analogue Outputs	UNSIGNED 8	RO	4
	1h	AO error value of channel 0	UNSIGNED 32	RW	0
	2h	AO error value of channel 1	UNSIGNED 32	RW	0
	3h	AO error value of channel 2	UNSIGNED 32	RW	0
	4h	AO error value of channel 3	UNSIGNED 32	RW	0
2004h	0h	Number of Analogue Outputs	UNSIGNED 8	RO	4
	1h	Type Code of AO Channel 0	UNSIGNED 8	RW	0x33
	2h	Type Code of AO Channel 1	UNSIGNED 8	RW	0x33
	3h	Type Code of AO Channel 2	UNSIGNED 8	RW	0x33
	4h	Type Code of AO Channel 3	UNSIGNED 8	RW	0x33

Table 3-8

This object 0x2004 controls the output type of the CAN-2024C. There are six kinds of output ranges for choices. These ranges and corresponding values are listed below.

Type Code Value	Output Type	Output Range	Hexadecimal
0x30	Current	0 ~ 20 mA	0x0000 ~ 0x7FFF
0x31	Current	4 ~ 20 mA	0x0000 ~ 0x7FFF
0x32	Voltage	0 ~ 10 VDC	0x0000 ~ 0x7FFF
0x33 (default)	Voltage	-10 ~ +10 VDC	0x8000 ~ 0x7FFF
0x34	Voltage	0 ~ 5 VDC	0x0000 ~ 0x7FFF
0x35	Voltage	-5 ~ +5 VDC	0x8000 ~ 0x7FFF

3.2 Store and Restore Object

Users can write the value 0x65766173 to the object index 0x1010 with subindex 1 to save application setting, or write the value 0x64616F6C to object index 0x1011 with subindex 1 to load the factory default. The following table lists the relative objects which will be stored or restored after writing these two objects. The factory default for these objects is also shown.

Index	Sub Index	Description	Factory Default
6443 h	1	Error Mode AO channel 0	0
	2	Error Mode AO channel 1	0
	3	Error Mode AO channel 2	0
	4	Error Mode AO channel 3	0
6444 h	1	AO error value of channel 0	0
	2	AO error value of channel 1	0
	3	AO error value of channel 2	0
	4	AO error value of channel 3	0
2004 h	1	Type Code of AO Channel 0	0x33
	2	Type Code of AO Channel 1	0x33
	3	Type Code of AO Channel 2	0x33
	4	Type Code of AO Channel 3	0x33

3.3 Application Object

Analogue Output module (0x6411)

User can use the object index 0x6411 with subindex 1 to read a group of 16-bit information. For example, if the node ID of the CAN-2024C is 1, the commands are listed as below:

11-bit COB-ID (bit)											RTR	Data Length	8-byte Data (byte)							
Func Code				Node ID									0	1	2	3	4	5	6	7
10	9	8	7	6	5	4	3	2	1	0										
1	1	0	0	0	0	0	0	0	0	1	0	8	40	11	60	01	00	00	00	00

SDO client → **SDO server (CAN-2024C)**

11-bit COB-ID (bit)											RTR	Data Length	8-byte Data (byte)							
Func Code				Node ID									0	1	2	3	4	5	6	7
10	9	8	7	6	5	4	3	2	1	0										
1	0	1	1	0	0	0	0	0	0	1	0	5	4B	00	60	01	FF	3F	--	--

SDO client ← **SDO server (CAN-2024C)**

Read the object index 0x6411 with subindex 1, and the value 0x3FFF of the AO channel 0 will be responded by CAN-2024C module.

User can use the object index 0x6411 with subindex 1 to write output value (Hex format) into CAN-2024C module. The commands are as follows.

11-bit COB-ID (bit)											RTR	Data Length	8-byte Data (byte)							
Func Code				Node ID									0	1	2	3	4	5	6	7
10	9	8	7	6	5	4	3	2	1	0										
1	1	0	0	0	0	0	0	0	0	1	0	8	2B	11	64	01	FF	2F	00	00

SDO client → **SDO server (CAN-2024C)**

11-bit COB-ID (bit)											RTR	Data Length	8-byte Data (byte)							
Func Code				Node ID									0	1	2	3	4	5	6	7
10	9	8	7	6	5	4	3	2	1	0										
1	0	1	1	0	0	0	0	0	0	1	0	4	60	11	64	01	--	--	--	--

SDO client ← **SDO server (CAN-2024C)**

Write the 0x2FFF value into the object index 0x6411 with subindex 1 of CAN-2024C, and the AO channel 0 will output the 5V if you select the 0~10 V output range.

Analogue Output Error Mode (0x6443)

This object defines whether an output is set to a pre-defined error value (see 6444h object) in case of an internal device failure or a 'Stop remote node' indication.

0 = actual value rest.

1 = reverts to error value integer (6444h).

others= reserved.

For example, if the node ID of the CAN-2024C is 1, the commands are as follows:

11-bit COB-ID (bit)											RTR	Data Length	8-byte Data (byte)							
Func Code				Node ID									0	1	2	3	4	5	6	7
10	9	8	7	6	5	4	3	2	1	0										
1	1	0	0	0	0	0	0	0	0	1	0	8	2F	43	64	01	01	00	00	

SDO client  **SDO server (CAN-2024C)**

11-bit COB-ID (bit)											RTR	Data Length	8-byte Data (byte)							
Func Code				Node ID									0	1	2	3	4	5	6	7
10	9	8	7	6	5	4	3	2	1	0										
1	0	1	1	0	0	0	0	0	0	1	0	4	60	02	60	01	--	--	--	--

SDO client  **SDO server (CAN-2024C)**

Write object index 0x6443 with subindex 1 to subindex 4, which can set each channel for actual value rest mode or reverts to error value integer mode.

Analogue Output Error Value Interger (0x6444)

On condition that the corresponding Error Mode is active, device failures will set the outputs to the value configured by this object (index = 0x6444).

For example, if the node ID of CAN-2024C is 1, the commands are shown below:

11-bit COB-ID (bit)											RTR	Data Length	8-byte Data (byte)							
Func Code				Node ID									0	1	2	3	4	5	6	7
10	9	8	7	6	5	4	3	2	1	0										
1	1	0	0	0	0	0	0	0	0	1	0	8	23	44	64	01	FF	3F	00	00

SDO client  **SDO server (CAN-2024C)**

11-bit COB-ID (bit)											RTR	Data Length	8-byte Data (byte)							
Func Code				Node ID									0	1	2	3	4	5	6	7
10	9	8	7	6	5	4	3	2	1	0										
1	0	1	1	0	0	0	0	0	0	1	0	4	60	44	64	01	--	--	--	--

SDO client



**SDO server
(CAN-2024C)**

Write the output value 0x3FFF into the object index 0x6444 with subindex 1. The CAN-2024C responds that it is successful.

Type Code for CAN-2024C Module (index = 0x2004)

Setting the type code will decide the output ranges of the CAN-2024C. If the node ID of the CAN-2024C is 1, the commands are listed as below:

11-bit COB-ID (bit)											RTR	Data Length	8-byte Data (byte)							
Func Code				Node ID									0	1	2	3	4	5	6	7
10	9	8	7	6	5	4	3	2	1	0										
1	1	0	0	0	0	0	0	0	0	1	0	8	2F	04	20	01	34	00	00	00

SDO client



**SDO server
(CAN-2024C)**

11-bit COB-ID (bit)											RTR	Data Length	8-byte Data (byte)							
Func Code				Node ID									0	1	2	3	4	5	6	7
10	9	8	7	6	5	4	3	2	1	0										
1	0	1	1	0	0	0	0	0	0	1	0	4	60	04	20	01	--	--	--	--

SDO client



**SDO server
(CAN-2024C)**

Write the type code value 0x34 into the object with index 0x2004 and subindex 1. The CAN-2024C responds that it is successful.

Error Mode and Error Value (0x6443, 0x6444)

The object 0x6443 and 0x6444 are used to control the safe value when the CAN-2024C is into stop mode or some error happens, such as node guarding failure, it will check the value of the object 0x6443. If some bits of the subindex 1 of this object are set to 1, the corresponding AO channels will output the error mode output values which are described in the corresponding subindex of the object 0x6444. For example, if set the value 1 into the object of 0x6443 with subindex 1 and a value 0x3FFF into the object 0x6444 with subindex 1 respectively, when some error event occurs, only the channel 0 will output the error mode output value 0x3FFF because the index 0x6443 with subindex 1 is set to 1. The others channels keeps the status as the error event is not happened.

11-bit COB-ID (bit)											RTR	Data Length	8-byte Data (byte)							
Func Code				Node ID									0	1	2	3	4	5	6	7
10	9	8	7	6	5	4	3	2	1	0										
1	1	0	0	0	0	0	0	0	0	1	0	8	2F	43	64	01	01	00	00	00

SDO client



**SDO server
(CAN-2024C)**

11-bit COB-ID (bit)											RTR	Data Length	8-byte Data (byte)							
Func Code				Node ID									0	1	2	3	4	5	6	7
10	9	8	7	6	5	4	3	2	1	0										
1	0	1	1	0	0	0	0	0	0	1	0	8	60	43	64	01	--	--	--	--

SDO client



**SDO server
(CAN-2024C)**

Write object index 0x6443 and subindex 1 to 0x01 means that setting the error mode to 0x01 for enabling the error mode output of channel 0.

11-bit COB-ID (bit)											RTR	Data Length	8-byte Data (byte)							
Func Code				Node ID									0	1	2	3	4	5	6	7
10	9	8	7	6	5	4	3	2	1	0										
1	1	0	0	0	0	0	0	0	0	1	0	8	23	44	64	01	FF	3F	00	00

SDO client



**SDO server
(CAN-2024C)**

11-bit COB-ID (bit)											RTR	Data Length	8-byte Data (byte)							
Func Code				Node ID									0	1	2	3	4	5	6	7
10	9	8	7	6	5	4	3	2	1	0										
1	0	1	1	0	0	0	0	0	0	1	0	8	60	44	64	01	--	--	--	--

SDO client



**SDO server
(CAN-2024C)**

Write object index 0x6444 and subindex 1 to 0x3FFF means that setting the error value to 0x3FFF for activating the error mode output value of channel 0. If the error event occurs, the module will output the safe value 0x3FFF corresponding the object 0x6443 and 0x6444.

3.4 Default PDO Mapping

RxPDO mapping list:

ID	Len	D 0	D 1	D 2	D 3	D 4	D 5	D 6	D 7
300h + x	8	AO_ C0_L	AO_ C0_H	AO_ C1_L	AO_ C1_H	AO_ C2_L	AO_ C2_H	AO_ C3_L	AO_ C3_H

Table 3-9 Default RxPDO list

Note: x is Node-ID of the module

Note: AO is Analogue Output

Note: C0, C1, C2 and C3 is channel 0, channel 1, channel 2 and channel 3.

Note: The 'L' indicates low byte and 'H' indicates high byte.