

ET-87P2/4/8 User Manual

Version 1.0.1, November 2011



ET-87P2



ET-87P4



ET-87P8

Written by Hans Chen
Edited by Anna Huang

Warranty

All products manufactured by ICP DAS are under warranty regarding defective materials for a period of one year, beginning from the date of delivery to the original purchaser.

Warning

ICP DAS assumes no liability for any damage resulting from the use of this product. ICP DAS reserves the right to change this manual at any time without notice. The information furnished by ICP DAS is believed to be accurate and reliable. However, no responsibility is assumed by ICP DAS for its use, not for any infringements of patents or other rights of third parties resulting from its use.

Copyright

Copyright © 2011 by ICP DAS Co., Ltd. All rights are reserved.

Trademark

The names used for identification only may be registered trademarks of their respective companies.

Contact US

If you have any problem, please feel free to contact us.
You can count on us for quick response.

Email: service@icpdas.com

Table of Content

1. Introduction	5
1.1. Features	6
1.2. Specification.....	12
1.3. Overview	14
1.4. Dimension	19
1.5. Companion CD	22
2. Getting Started	23
2.1. Mounting the Hardware.....	24
2.2. Inserting the I/O Modules.....	27
2.3. Configuring the Boot Mode	30
2.3.1. Init Mode	31
2.3.2. Lock Mode.....	31
2.3.3. Running Mode.....	32
2.4. Installing Tools and Utilities	33
2.5. Assigning a New IP Address	35
2.5.1. Assign a New IP Address Using MiniOS7 Utility.....	36
2.5.2. Using Man-Machine Interface to Assign an IP Address.....	40
2.6. Creating Virtual COM Ports Using VxComm Utility.....	44
2.7. Establishing PC to ET-87P2/4/8 Communications.....	49
3. I/O Configuration.....	52
3.1. Creating the I/O Configuration	53
3.2. Checking the I/O Configuration.....	57
3.3. Backing up/Restore the I/O Configuration	59
3.3.1. Backing up the I/O Configuration	59

3.3.2. Restoring/Importing the I/O Configuration	60
3.3.3. Restoring/Importing the I/O Configuration and Writing to 87P4/8.....	63
3.4. Saving the I/O Configuration File without ET-87P2/4/8 Online	65
4. Tools and SDKs	68
4.1. Tools	69
4.1.1. DCON Utility	70
4.1.2. MiniOS7 Utility.....	71
4.1.3. VxCOMM Utility.....	72
4.2. SDKs	73
5. ET-87P2/4/8 Updates	74
5.1. OS updates	74
5.2. Firmware Updates.....	80
Appendix A. Frame Ground.....	86
Appendix B. I/O Configuration Files.....	87
Appendix C. Troubleshooting	88
Appendix D. Technical Support	91

1. Introduction

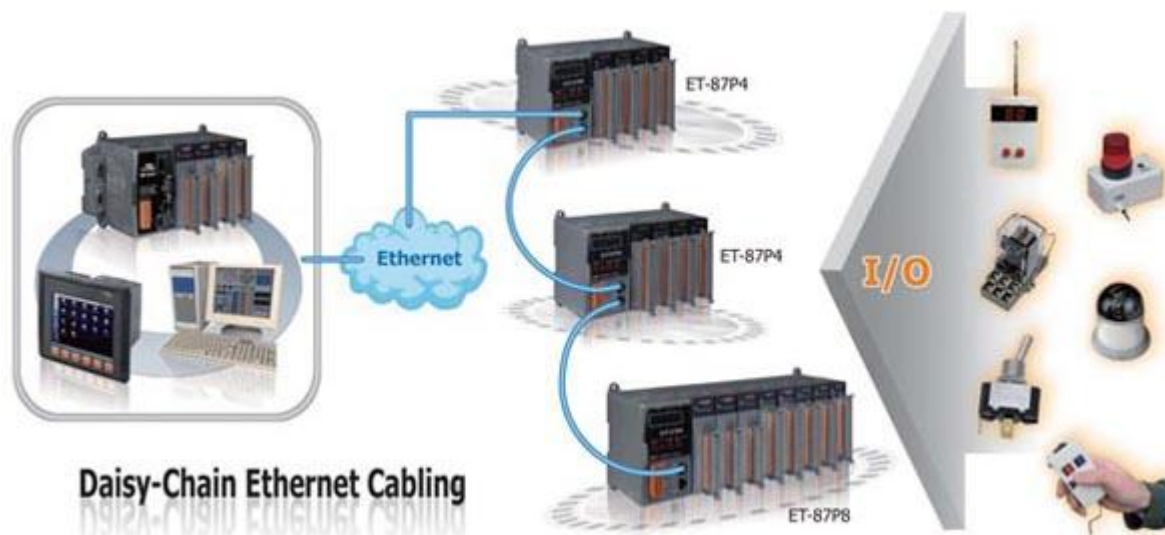

ET-87P2/4/8 series is a remote intelligent I/O expansion unit to expand I-87K series I/O modules over the Ethernet for industrial monitoring and controlling applications. It offers two Ethernet switch ports to form a daisy-chain topology. The daisy-chain feature allows ET-87P2/4/8 to connect in series to each other or other Ethernet devices. Users can easily simplify the cabling and save installation space with the feature.

ET-87P2/4/8 is designed to be used in harsh and noisy environment, so the hardware is manufactured with wide power input range (10~30 V_{DC}), isolated power input and can operate under wide temperature (-25 °C ~ +75 °C). To simplify installation and maintenance of I/O modules, it provides many useful features, such as: hot swap allowed, auto configuration, LED indicators for fault detection, dual watchdog to keep alive, programmable power on and safe values for safety.

There are more than 30 I/O modules supported with the unit, including analog input/output, digital input/output, counter, frequency I/O modules. We provide various software development kits (SDK) and demos, such as DLL, ActiveX, Labview driver, InduSoft driver, Linux driver, OPC server, etc. The I-87K series I/O modules plugged in the ET-87P2/4/8 can be easily integrated into variant software system.

1.1. Features

Here is a summary of the key features which the ET-87Pn offers.

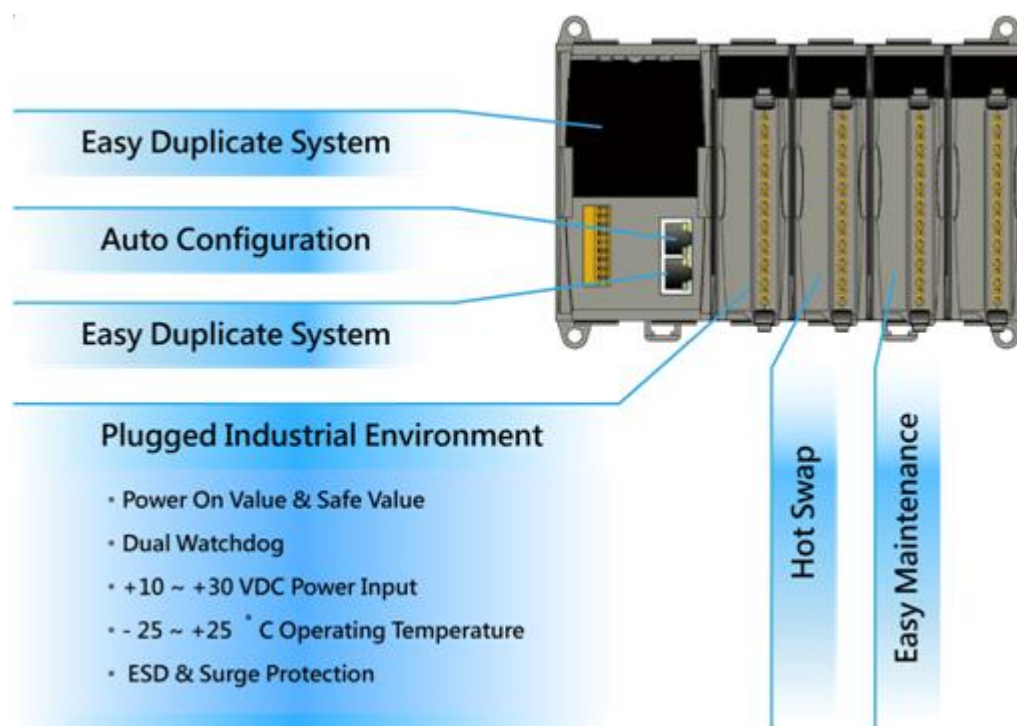

Hot Swap

Reliable 3-piece construction enables users to hot swap modules during operation, without rewiring. All I/O module data are backed up in the non-volatile memory of the ET-87n. After hot-swapping a module, all settings are automatically loaded to recover.

Auto Configuration

The I-87K I/O modules can be pre-configured and backed up in the non-volatile memory of the ET-87Pn. When the ET-87Pn is power on or plugged in, the ET-87Pn will automatically checks and restores these configurations to each I-87K I/O modules on it.

Multi-Host Access

Simultaneous access by a maximum of 6 host PCs.

Although a maximum of 6 host PCs are allowed simultaneous access, it is recommended that fewer host PCs are used in order to give better performance and stability.

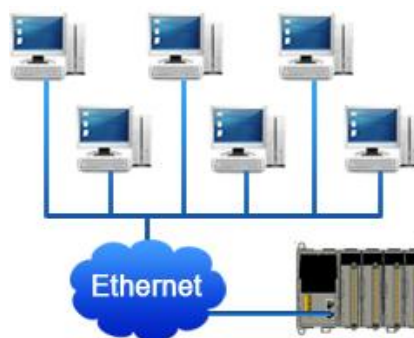

Easy Duplicate System

Using the DON Utility, you can easily make a backup of the I-87K module configurations and write to another ET-87Pn. This design can easily and quickly duplicate many ET-87Pn.



Easy Maintenance and Diagnosis

The basic configurations (includes IP settings) are set by the push buttons and 7-segment LED display. The operator can easily set the ET-87Pn. And there are several LED status indicators to show whether I-87K modules are configured and work properly.

If one I-87K module fails, the operator just needs to replace it with one good I-87K module with the same item number. And then checks the LED indicators to know whether the replacement is performed correctly. The push buttons and LED display design makes it easy for maintenance. There is no PC and Notebook needed.

Various Software Develop Toolkits

DLL, ActiveX, Labview driver, Indusoft driver, DasyLab driver, Linux driver.

Fully Software Support

The free charge software utility and development kits include

- **DCON Utility:** for configuration
- **OPC Servers:**
OPC is an industrial standard interface based on OLE technology.
With the OPC server, I/O modules can be easily build the data logger software without any programming skill.

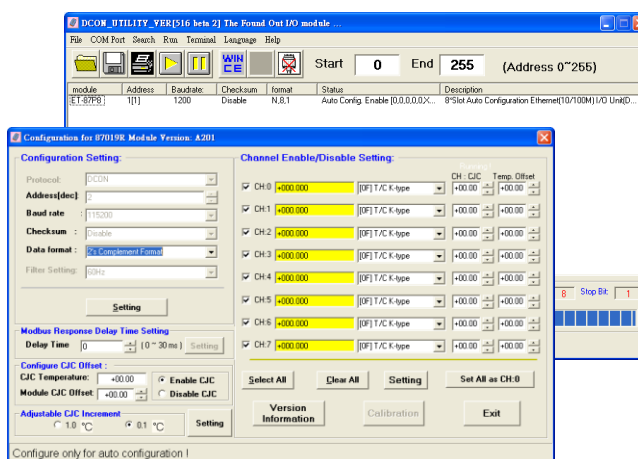

EZ Data Logger

EZ Data Logger is the small data logger software. It can be applied to small remote I/O system. With its user-friendly interface, users can quickly and easily build the data logger software without any programming skill.

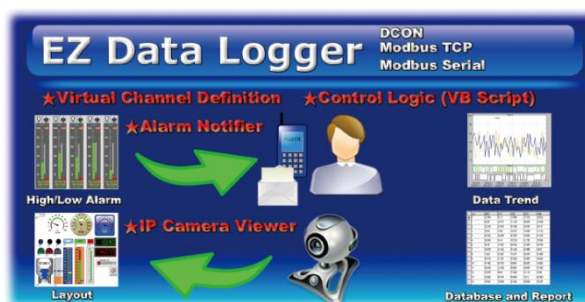

Communication

Daisy-Chain Ethernet topology

The ET-87Pn has a built-in two-port Ethernet switch to implement daisy-chain topology. The cabling is much easier and total costs of cable and switch are significantly reduced.

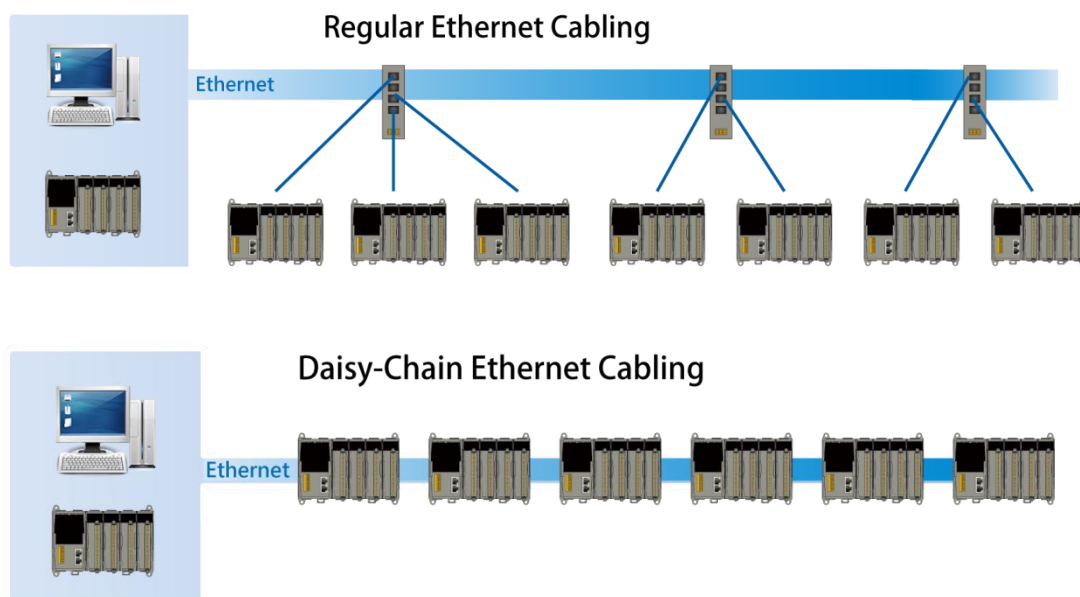

LAN Bypass Feature

LAN Bypass feature guarantees the Ethernet communication. It will automatically activate to continue the network traffic when ET-87Pn lost its power.

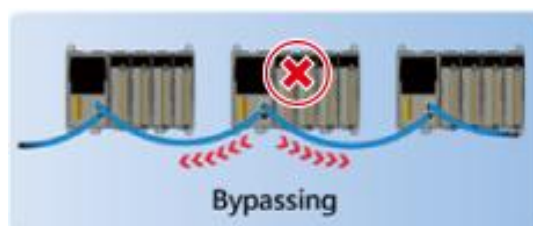

DCON Protocol

I-87K series I/O modules plugged in a ET-87Pn provide a simple command/response protocol (called DCON protocol) for communication. All command/response are in easy used ASCII format.

- **Dual Watchdog Design**

The I-87K series I/O modules provides module watchdog and host watchdog. The module watchdog is a hardware watchdog; the host watchdog is a software watchdog. The module watchdog is designed to automatically reset the microprocessor when the module hangs. The host watchdog monitors the host controller (PC or PLC). The output of module can go to the safe value state when the host fails.

- **Programmable Power On Value & Safe Value**

The DO and AO type I-87K I/O modules provide programmable Power On Value & Safe Value. When ET-87Pn is power on or plugged in, The DO or AO modules output preconfigured Power On Value. When host watchdog is acted, DO or AO modules output preconfigured Safe Vale.

- **Wide Range Power Input (10 ~ 30 V_{DC})**

- **Wide Range Operating Temperature (-25 ~ +75 °C)**

Ethernet Remote I/O Module

The I-87Kn I/O modules can support the expansion of the ET-87Pn and can be divided into the high profile I/O modules and the low profile I/O modules, only i-87K high profile series I/O modules can support Hot Swap and Auto-Configuration function correctly.

ET-87Pn with I-87Kn Comparison

Supported	ET-87Pn with Auto Config. Enable	ET-87Pn with Auto Config. Disable	i-87Kn
i-87K Low Profile module	--	--	Y
i-87K High Profile module	Y	Y	Y
i-87K module Hot Swap	Y	Y	--
Auto- Communication parameter Setup	Y	Y	--
Auto-Configuration	Y	--	--

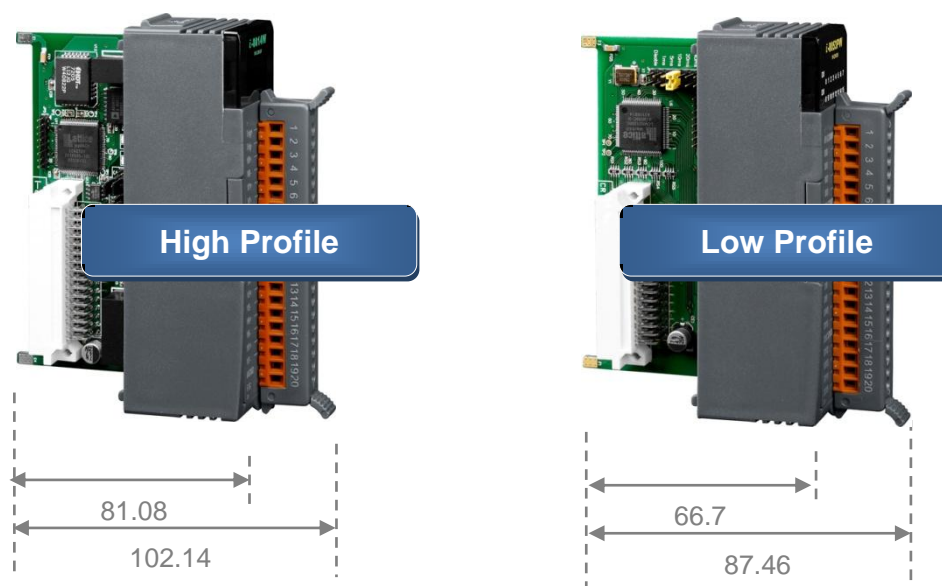

Please refer to web page :

http://www.icpdas.com/products/PAC/i-8000/8000_IO_modules.htm

1.2. Specification

Ethernet	ET-87P2	ET-87P4	ET-87P8
Port	RJ45 * 2, 10/100 Base-TX (Auto-negotiating, Auto MDI/MDI-X, LED indicators)		
Cabling	Daisy-Chain Ethernet Cabling		
Isolation	3000 V _{DC}		
ESD Protection	+/- 4K contact Discharge and +/- 8K Air Discharge		
Communication Protocol	DCON Protocol (ASCII format)		

LED Display	ET-87P2	ET-87P4	ET-87P8
Power	Yes		
System Ready	Yes		
Auto Configuration	Yes		
Slot Status	Yes		
IP Address	Yes (with push buttons to configure IP address)		

I/O Expansion Slots	ET-87P2	ET-87P4	ET-87P8
I/O Module Hot Swap	Yes		
Auto Configuration	Yes		
Support Module Type	High profile I-87K module only		
Slots	2	4	8

Mechanical	ET-87P2	ET-87P4	ET-87P8
Dimension (W x H x D)	126 x 132 x 111 mm	188 x 132 x 111 mm	312 x 132 x 111 mm

Environment	ET-87P2	ET-87P4	ET-87P8
Operating Temperature	-10 °C ~ +75 °C		
Storage Temperature	-30 °C ~ +75 °C		
Humidity	5 ~ 95 %, non- condensing		

Power	ET-87P2	ET-87P4	ET-87P8
Input Range	10 ~ 30 V _{DC} (non-regulated)		
Redundant Input	Yes		
Reverse polarity protection	Yes		
Isolation	3000 V _{DC}		
Frame Ground	Yes		
Consumption	2 W	2 W	2.4 W
Power Board Driving	10 ~ 30 V _{DC} (non-regulated)		

1.3. Overview

Here is a brief description of the components.

ET-87P2

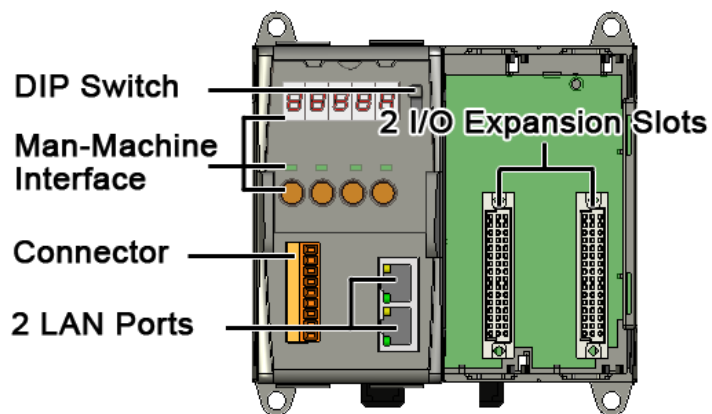

ET-87P4

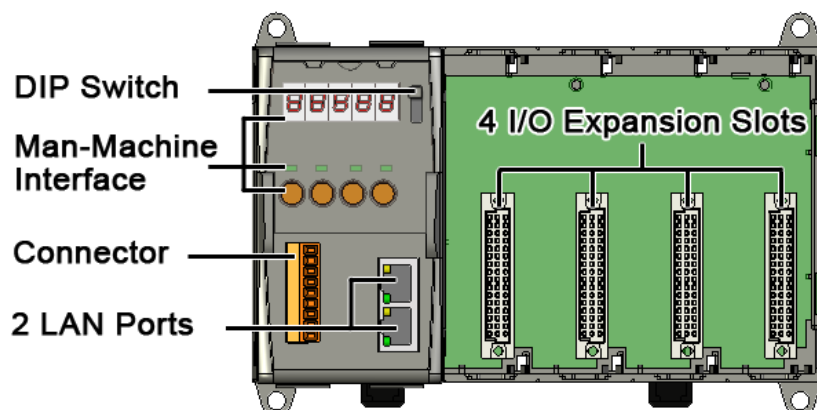

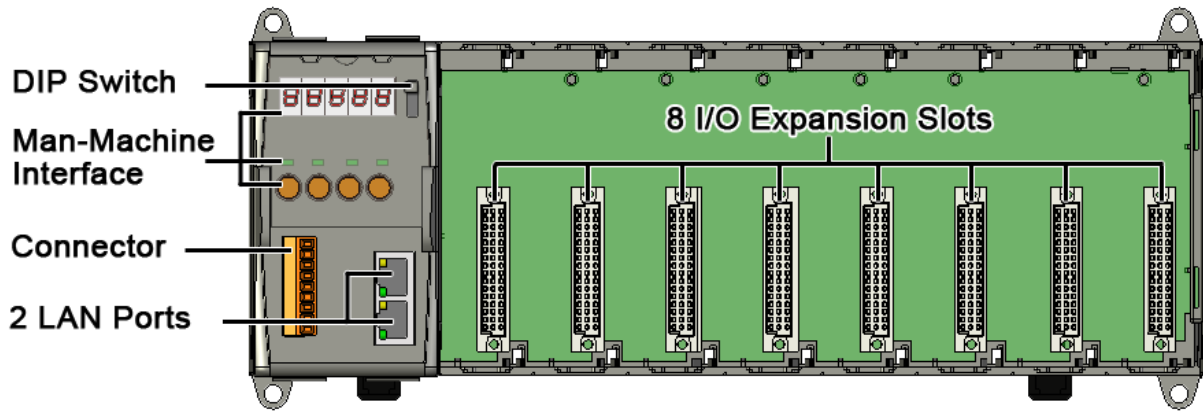

● **DIP Switch**

The DIP Switch is an operating mode selector switch which provides three functions in the unit, the selection of operating mode and authorization control for the ET-87P2/4/8.

For more information about the operating mode, please refer to “2.3. Configuring the Boot Mode”

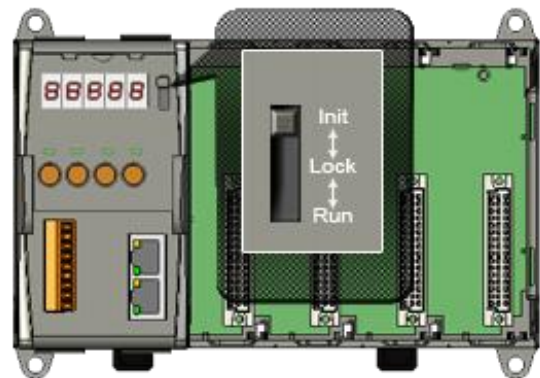

● **Man-Machine Interface**

The ET-87P2/4/8 Man-Machine interface includes LED displays, status indicators and function buttons.

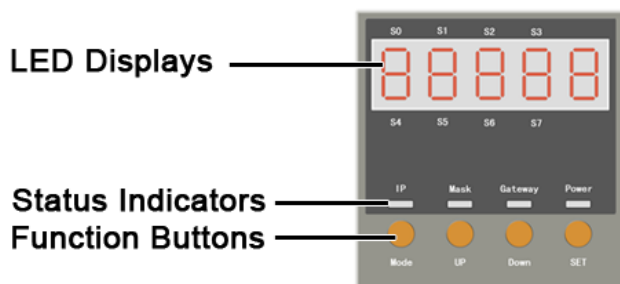

LED Displays

The LED displays (5-Digital 7-Segment LEDs) show the I/O configuration error, warning status or IP settings.

Status Indicators

The indicators indicate which the parameter is displayed in LED displays and whether the power is on or not.

Status Indicator	Description
IP	The IP indicator indicates the IP address which is displayed in LED displays.
Mask	The Mask indicator indicates the Mask which is displayed in LED displays.
Gateway	The Gateway indicator indicates the Gateway which is displayed in LED displays.
Power	The Power indicator indicates whether power is on or not.

Function Buttons

The function buttons allow the user to navigate through the configuration and or adjusting set-points.

Function Button	Description
Mode	The Mode button switches to the configuration mode. If already in configuration mode, the set-point will move to the next configuration parameter.
UP	In configuration mode, the UP key scrolls through the parameter value, and can increase the parameter values.
Down	In configuration mode, the Down key scrolls through the parameter value, and can decrease the parameter values.
SET	The SET button shows the parameter values in the LED display. If in configuration mode, the SET button will move the set-point.

● Connector

The connector provides an interface for supplying power to the unit, exchanging data between the unit and PC or external device, and grounding the unit.

The pin assignments of the connector are as follows:

Pin	Signal	Description
1	PWR1	PWR1
2	P.GND	
3	PWR2	PWR2
4	P.GND	
5	N.C.	Unassigned
6	GND	RS-232
7	TxD	
8	RxD	
9	F.G.	Frame Ground

● 2 LAN Ports

The ET-87P2/4/8 has two Ethernet ports. One port is used to interface with a network, and other is used as a router to set up a daisy chain topology.

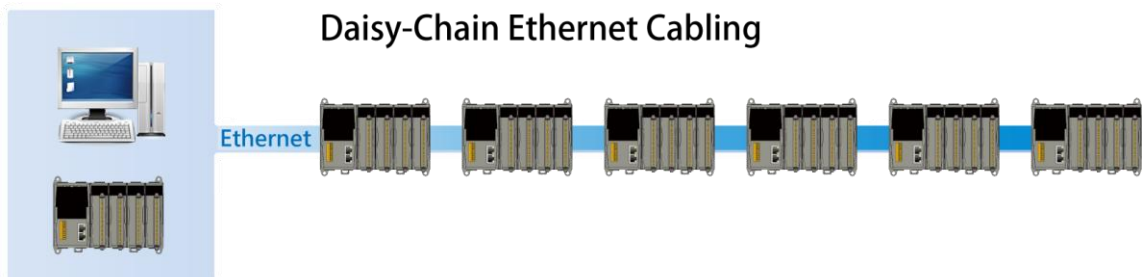

- **2/4/8 I/O Expansion Slots**

The ET-87P2/4/8 has 4/8 I/O expansion slots to expand the functions of the ET-87P2/4/8, each I/O expansion slots has different numbers for use with the I/O modules. The ET-87P2/4/8 has 2/4/8 I/O expansion slots that are numbered 0-1/0-3/0-7. Complete I/O module specifications and wiring diagrams can be found in

http://www.icpdas.com/products/PAC/i-8000/8000_IO_modules.htm#i87

For example, the ET-87P4 has 4 I/O expansion slots, the I/O slots are numbered 0-4.

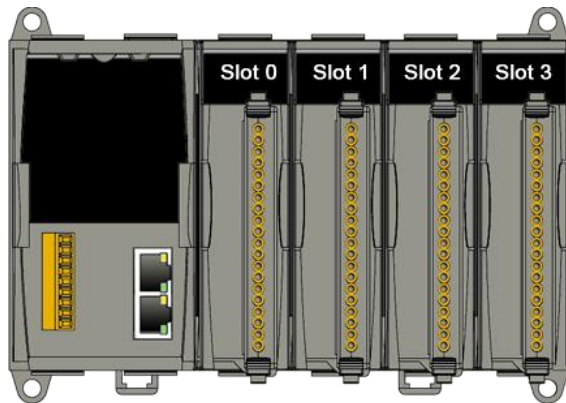

1.4. Dimension

The diagrams below provide the dimensions of the ET-87P2/4/8 to use in defining your enclosure specifications. Remember to leave room for potential expansion if you are using other components in your system.

The height dimension is the same for all ET-87P2/4/8. The width depending on your choose of I/O expansion slots. All dimensions are in millimeters.

ET-87P2

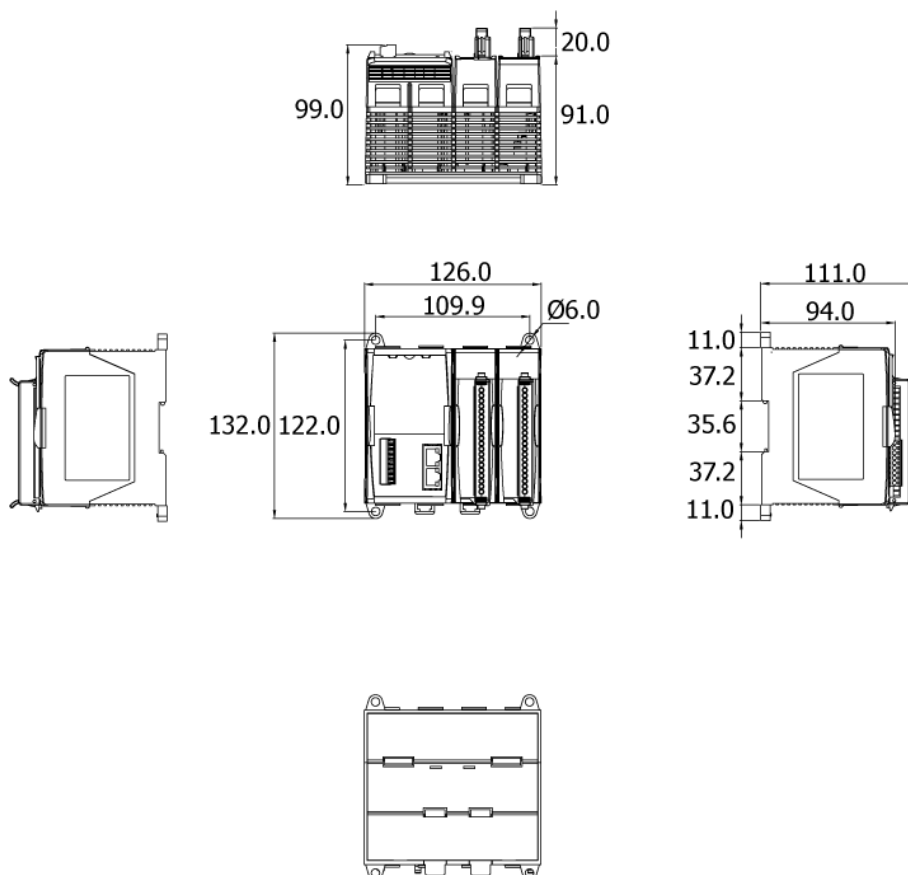

ET-87P4

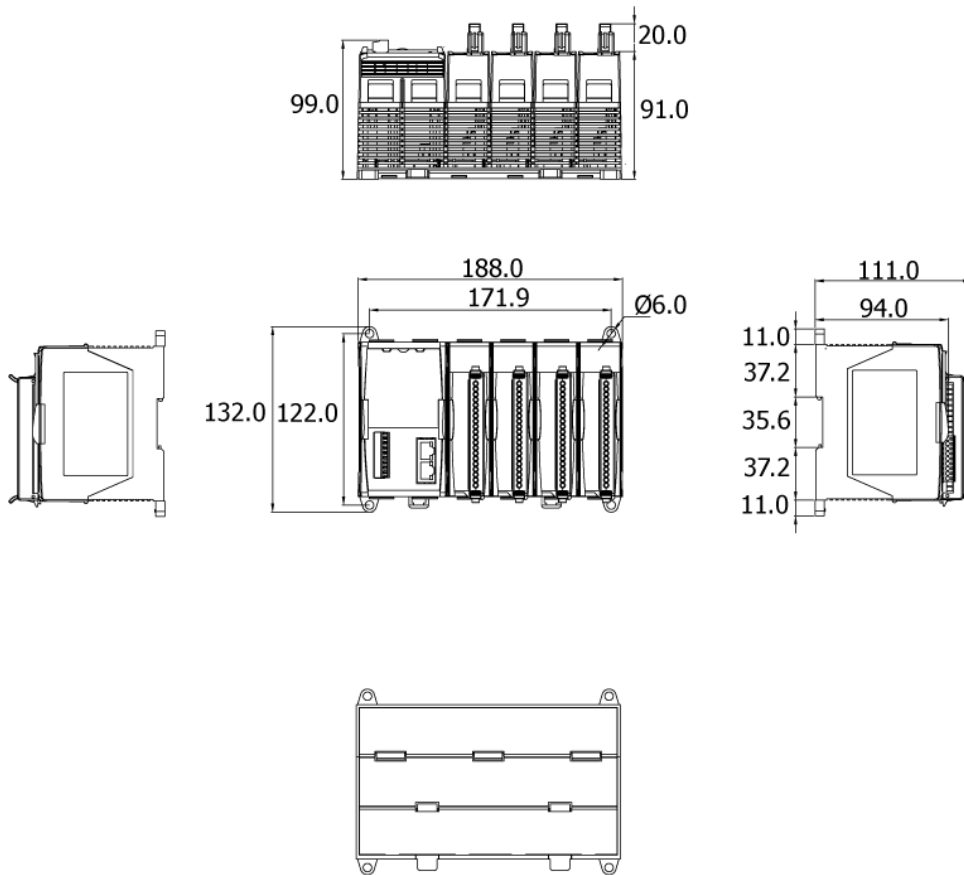

ET-87P8

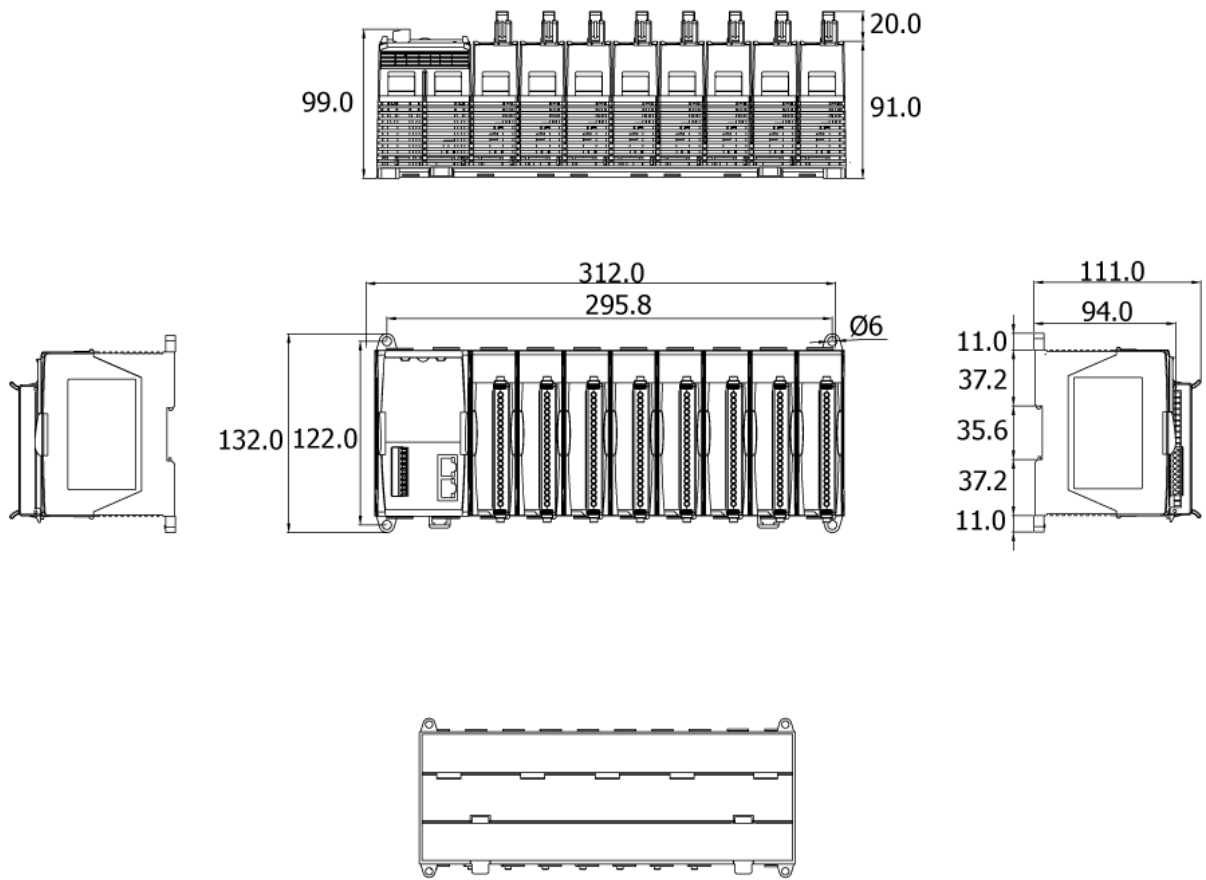

1.5. Companion CD

This package comes with a CD that provides drivers, software utility, all of the required documentations..., etc. All of them are listed below.

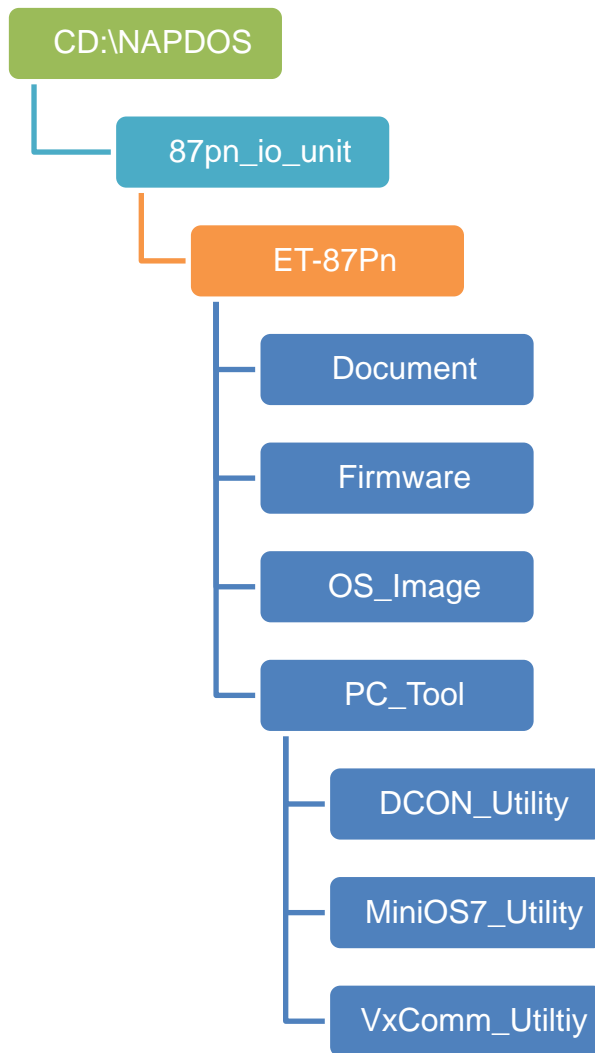

2. Getting Started

If you are a new user, begin with this chapter, it includes a guided tour that provides a basic overview of installing, configuring and using the ET-87P2/4/8.

Before beginning any installation, please check the package contents. If any items are damaged or missing, please contact us.

In addition to this guide, the package includes the following items:



**ET-87Pn Module
(ET-87P2/4/8)**



Software Utility CD



**Screw Driver
(1C016)**

2.1. Mounting the Hardware

Before installing the hardware, you should have a basic understanding of hardware specification, such as the dimensions, the usable input-voltage range of the power supply, and the type of communication interfaces.

For more information about the hardware details, please refer to “1.1. Specifications”
For more information about the hardware dimensions, please refer to “1.3. Dimension”

Step 1: Mounting the ET-87P2/4/8

The ET-87P2/4/8 can be mounted with the bottom of the chassis on the standard 35 mm DIN rail, or it can be surface mounted. Make sure the following installation requirements are met.

- **Temperature Considerations.**

Operating Temperature: $-10^{\circ}\text{C} \sim +75^{\circ}\text{C}$

Storage Temperature: $-30^{\circ}\text{C} \sim +75^{\circ}\text{C}$

Humidity: 5 ~ 95%, Non-condensing

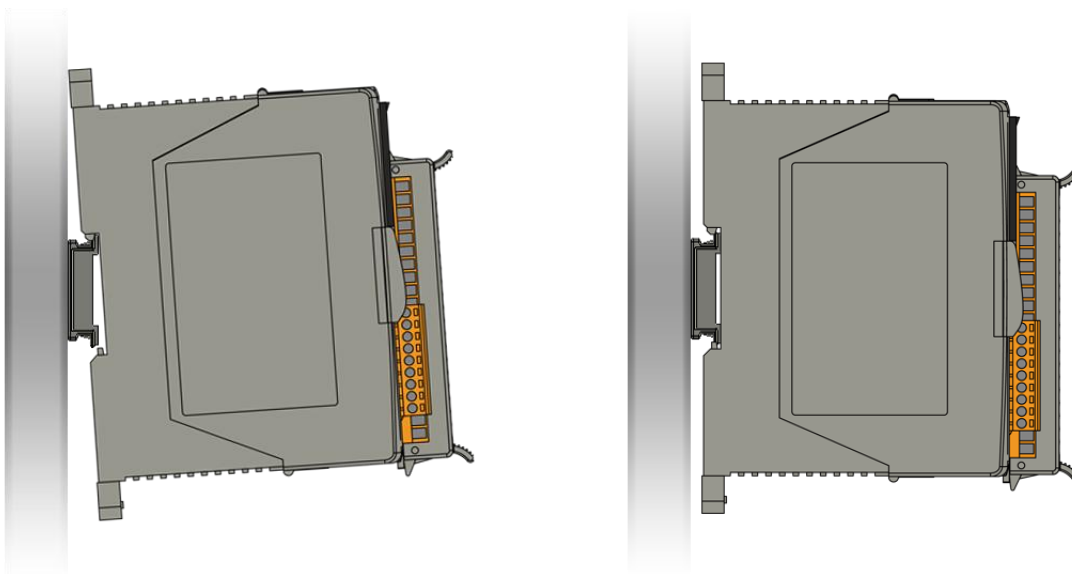

• Mounting Clearances

The ET-87P2/4/8 installation must provide proper ventilation, spacing, and grounding to ensure the equipment will operate as specified. A minimum clearance of 50mm between the ET-87P2/4/8 and the top and bottom side of the enclosure panels must be provided.

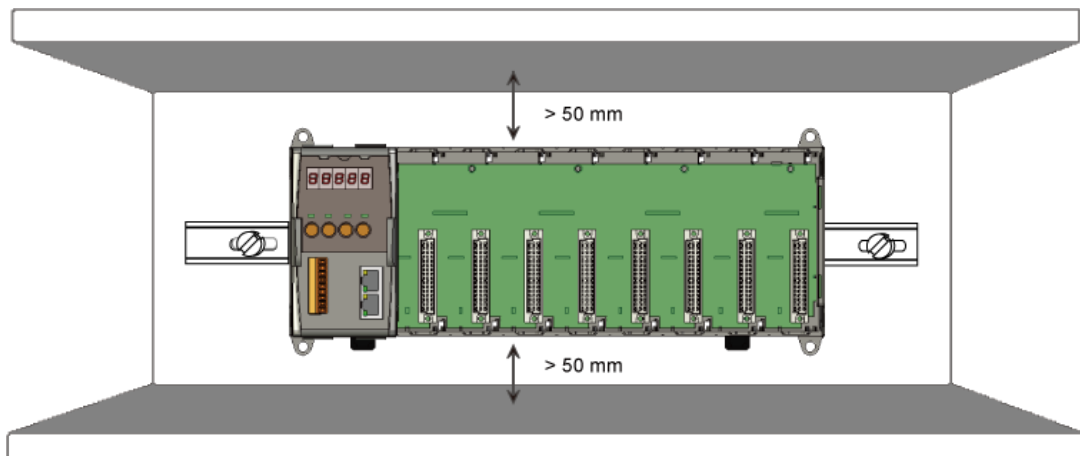

Step 2: Connecting to power supply

The ET-87P2/4/8 has redundant power, you can be powered by +10 ~ +30 VDC via one of power supplies. The following diagram shows the terminal connections located on the power supply of the ET-87P2/4/8.

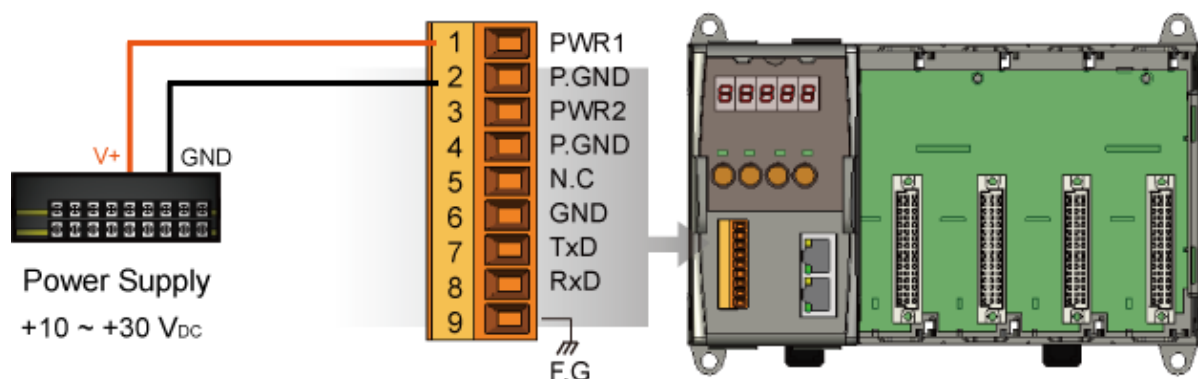

Step 3: Connecting to network and PC

The ET-87P2/4/8 is equipped with RJ-45 Ethernet ports for connection to network and PC

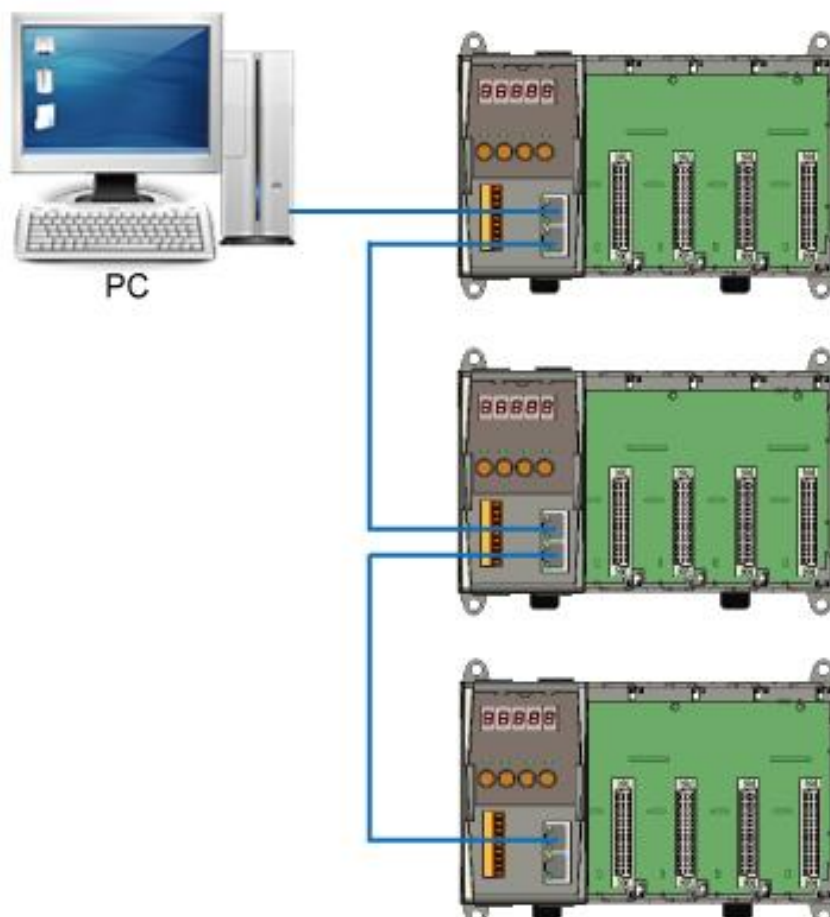

2.2. Inserting the I/O Modules

The ET-87P2/4/8 has 4/8 I/O expansion slots to expand the functions of the ET-87P2/4/8, allowing it to communicate with external I/O modules, and before choosing the right I/O modules, you first need to know the I/O expansion capacities in order to choose the best expansion module for achieving maximal efficiency.

There are more than 30 high profile I/O modules available for interfacing many different measurements, including thermocouple, voltage, RTD, current, resistance, strain, digital, ..., etc., and these modules have their own manuals, so if you are using them you should supplement this manual with the manual specifically designed for the special module.

For more information about the I/O expansion modules that are compatible with the ET-87P2/4/8, please refer to

http://www.icpdas.com/products/PAC/i-8000/8000_IO_modules.htm#i87

Tips & Warnings



The ET-87Pn only can support the high profile I/O modules.

Step 1: Align circuit card with slot and press firmly to seat module into connector

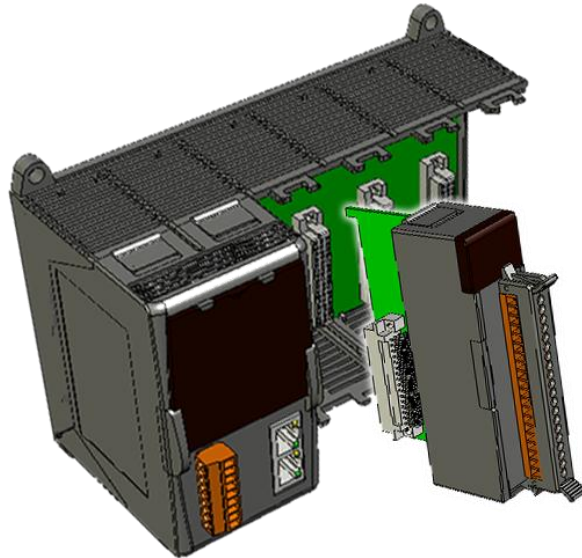

Step 2: Pull top and bottom locking tabs toward module face. Click indicates lock is engaged.

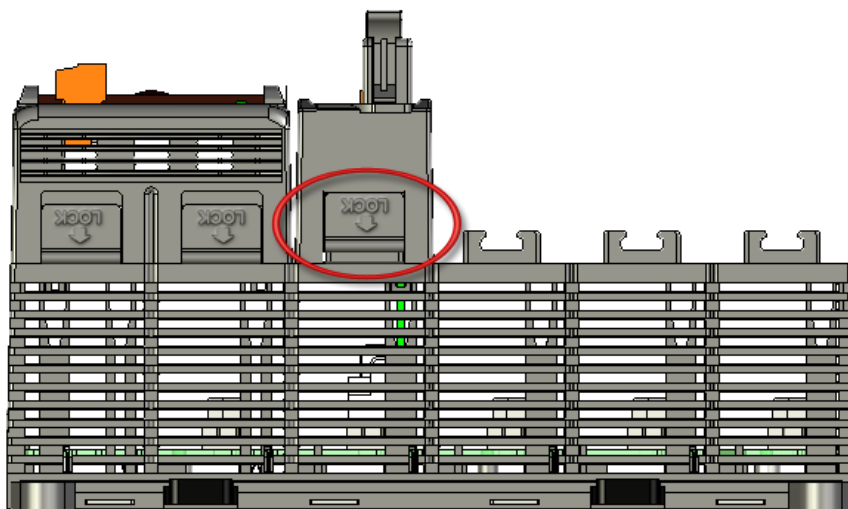

Step 3: Wiring the I/O modules to the monitored Inputs and Voltages

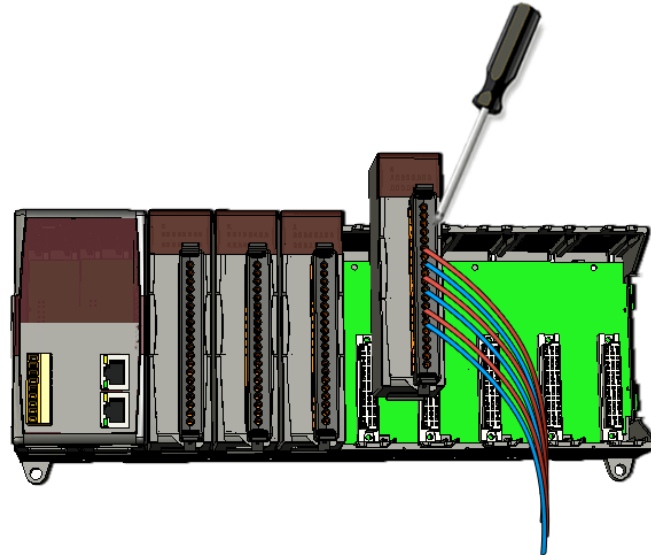

2.3. Configuring the Boot Mode

The ET-87P2/4/8 can be configured in three modes of operation to provide has three operating modes that can be determined through a DIP switch.

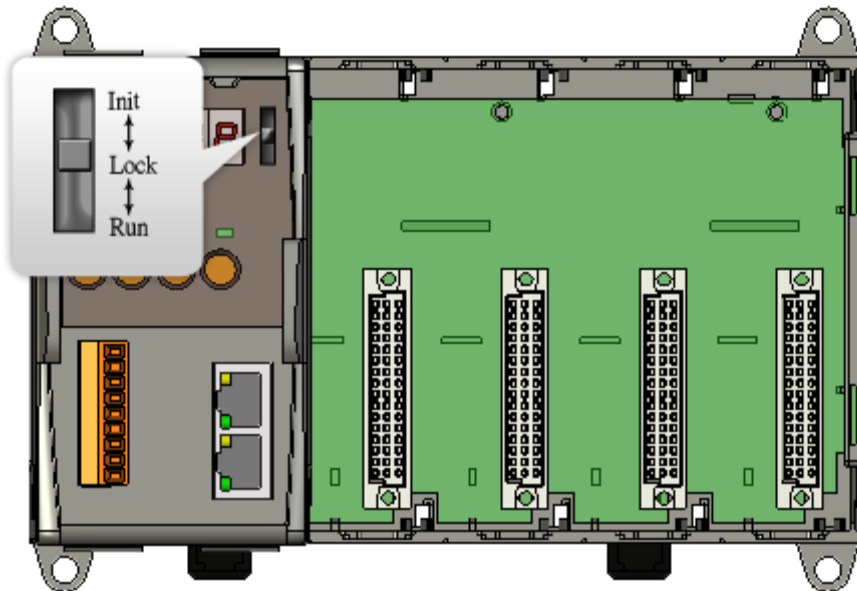

Switch Position	Mode of Operation	Description
Init	Init Mode	OS cannot execute autoexec.bat
		Flash can be read/write
Lock	Lock Mode	OS can execute autoexec.bat
		Flash is read only (lock)
Run	Running Mode	OS can execute autoexec.bat
		Flash can be read/write

2.3.1. Init Mode

Init mode is used to update the OS image and upgrade the firmware. If dip switch is set as Init mode and reset the power, the ET-87P2/4/8 cannot boot up with autoexec.bat and will enter OS operation mode, in this case there is no program running on the ET-87P2/4/8 and the 5-digit 7-SEG LEDs will count the number as shown below:

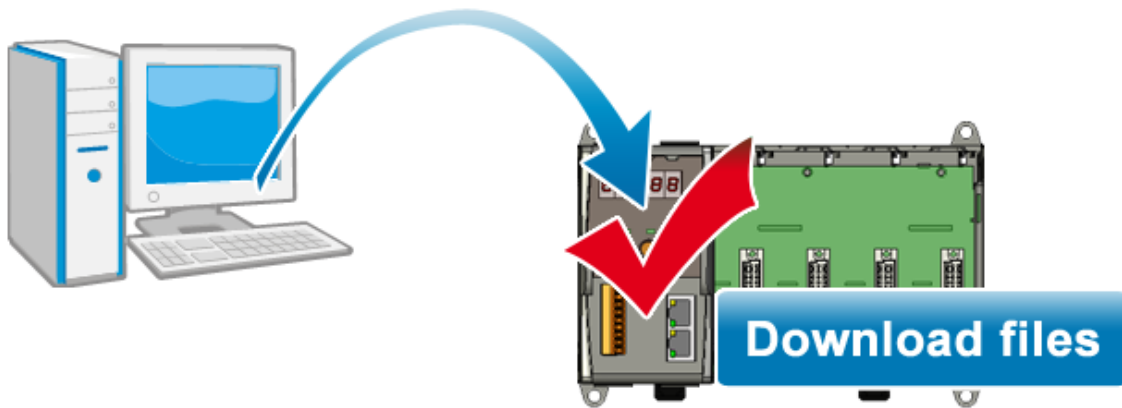

2.3.2. Lock Mode

The lock mode prevents the data from being programmed in the memory unless an unlock sequence precedes the loading of the data that is to be programmed into the memory

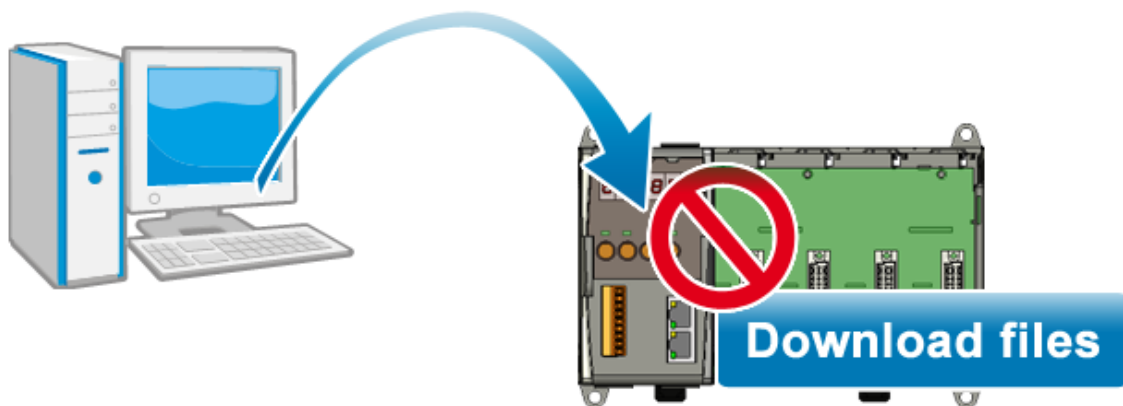

2.3.3. Running Mode

The running mode represents there is the program running on the ET-87P2/4/8 and the 5-digits 7-SEG LEDs will show the message according to the running program, but if during this time there is another program running on ET-87P2/4/8, the 5-digits 7-SEG LEDs isn't managed with this program, it will stop motion at the present state.

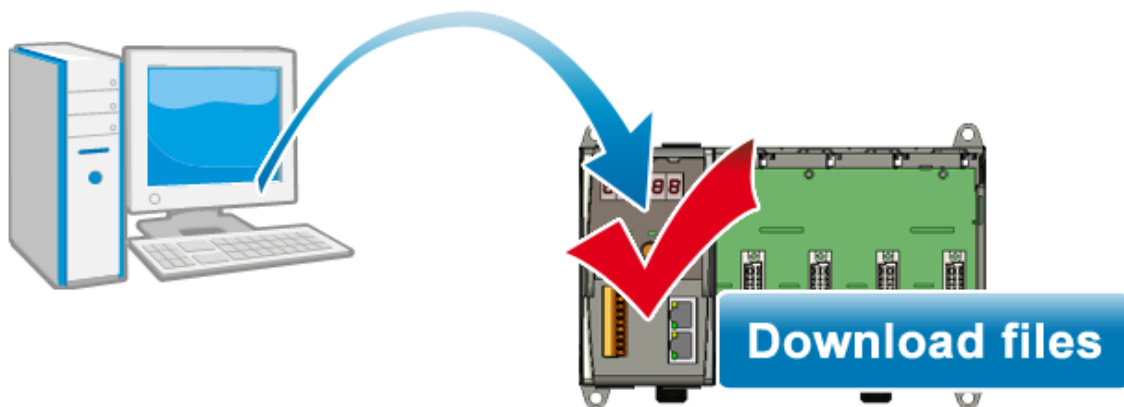

2.4. Installing Tools and Utilities

Following tools and utilities has been installed on the system:

- **MiniOS7 Utility**

The MiniOS7 Utility is a comprehensive suite of software tools that helps you update OS image or firmware, configure Ethernet settings, and download files to ET-87P2/4/8 from PC.

For more detailed information on how to update the firmware and OS, please refer to “5. ET-87P2/4/8 Updates”



The MiniOS7 Utility can be obtained from companion CD or our FTP site:

CD:\Napdos\minios7\utility\minios7_utility\

ftp://ftp.icpdas.com/pub/cd/8000cd/napdos/minios7/utility/minios7_utility/

- **VxComm Utility**

The VxComm Utility has the ability to create virtual COM ports that are actually TCP/IP port connections. This means that any software designed to communicate with RS-232 ports can now communicate over Ethernet or Internet TCP/IP ports



The VxComm Utility can be obtained from companion CD or our FTP site:

CD:\Napdos\driver\vxcomm_driver\

ftp://ftp.icpdas.com/pub/cd/8000cd/napdos/driver/vxcomm_driver/

- **DCON Utility**

DCON Utility is a tool that allows you to easily and quickly monitor, manage and configure the I/O expansion modules.



DCON_Utility

The DCON Utility can be obtained from companion CD or our FTP site:

CD:\Napdos\driver\dcon_utility\

ftp://ftp.icpdas.com/pub/cd/8000cd/napdos/driver/dcon_utility/

2.5. Assigning a New IP Address

The ET-87P2/4/8 is Ethernet I/O unit, which comes with a default IP address. Therefore, you must first assign a new IP address and the subnet mask and gateway for this IP address to ET-87P2/4/8 on your network.

The factory default IP settings are as follows:

Item	Default
IP Address	192.168.255.1
Subnet Mask	255.255.0.0
Gateway	192.168.0.1

The IP settings of the ET-87P2/4/8 can be set in one of three ways.

- Using MiniOS7 Utility
- Use ET-87P2/4/8 Web Site
- Use Man-Machine Interface

2.5.1. Assign a New IP Address Using MiniOS7 Utility

MiniOS7 Utility is an easy-to-use network configuration Utility. You can configure the ET-87P2/4/8 to connect to a LAN by using it.

Step 1: Reboot the ET-87P2/4/8 at Run mode

Make sure the switch is set to the “Run” position before you boot up the ET-87P2/4/8.

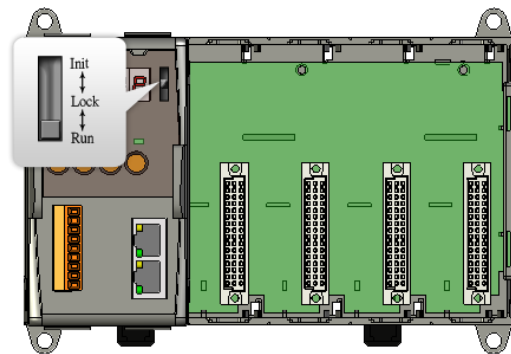

Step 2: Run the MiniOS7 Utility

Double-click the MiniOS7 Utility shortcut on your desktop.

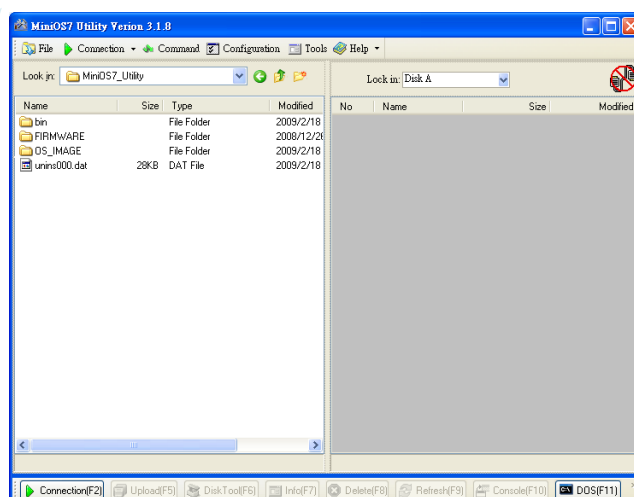

Step 3: Choose “Search” from the “Connection” menu

After choosing Search from Connection menu, that will search all of the MiniOS7 modules on your network.

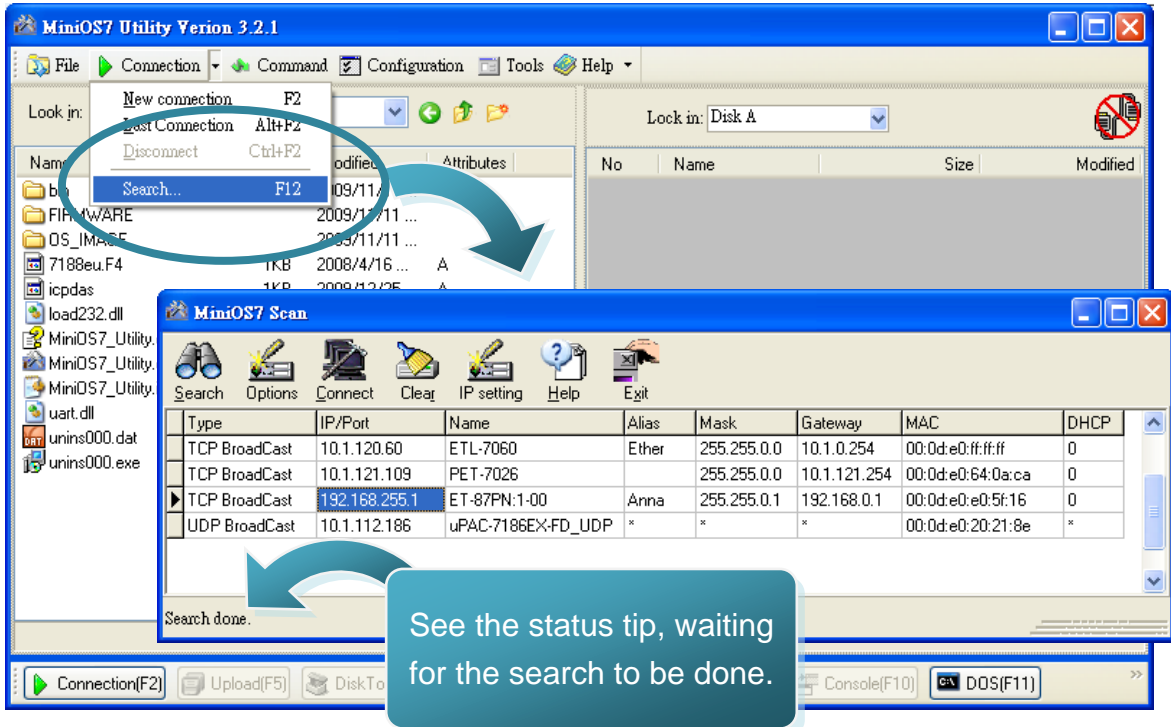

See the status tip, waiting for the search to be done.

Step 4: Choose the field “192.168.255.1” from the list and then Press “IP setting” button from the toolbar

Choose default value “192.168.255.1” for fields in the list, and then choose IP setting from the toolbar.

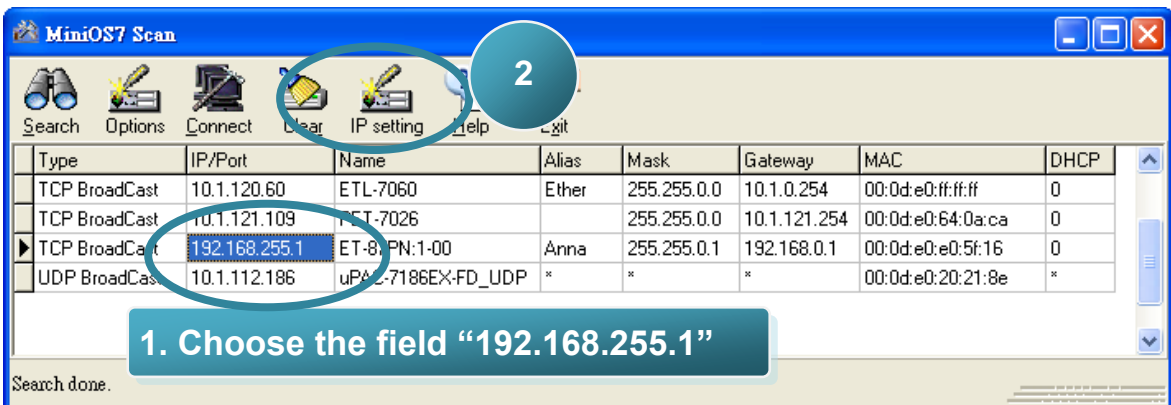

1. Choose the field “192.168.255.1”

Step 5: Assign a new IP address and then choose “Set” button

You can manually assign an IP address or use DHCP to dynamically assign IP addresses

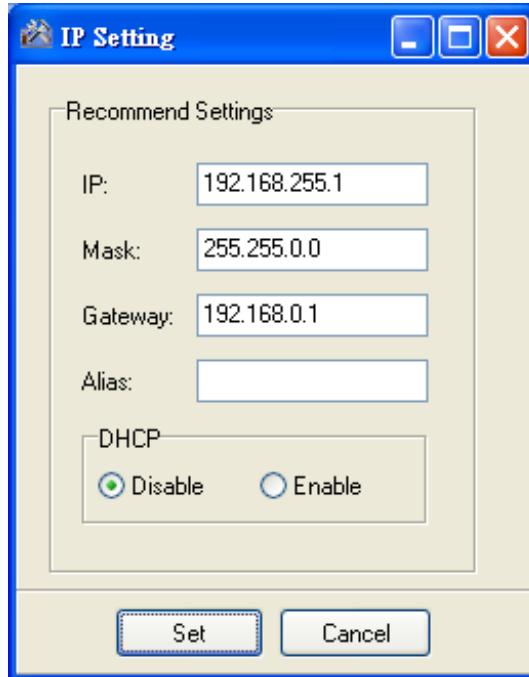

Step 6: Choose “Yes” button

After completing the settings, the Confirm dialog box will appear, and then choose the Yes button to exit the procedure.

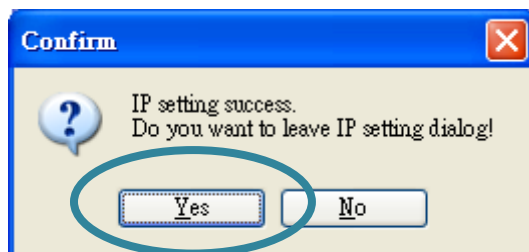

Step 7: Reboot the module and then choose “Search” from the “Connection” menu to check the IP setting

After completing the settings, you can reboot the module and then using MiniOS7 to search module again for making sure that your IP settings are correct.

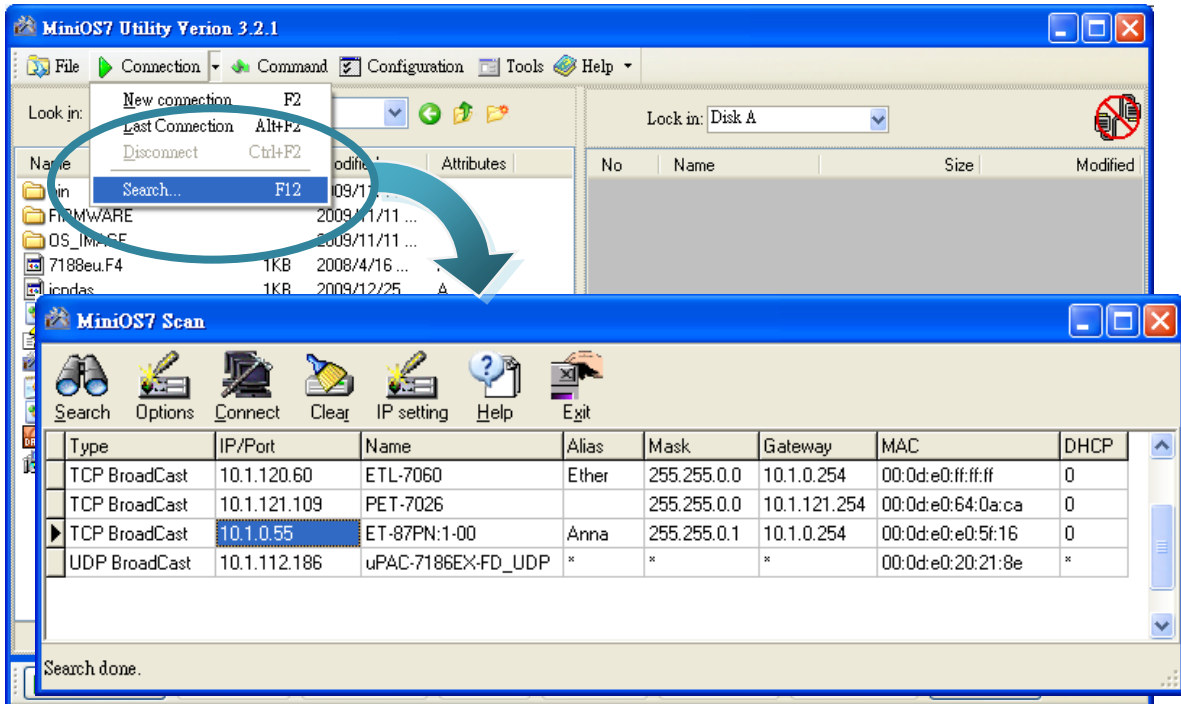

2.5.2. Using Man-Machine Interface to Assign an IP Address

The ET-87P2/4/8 Man-Machine Interface consists of an operator panel. You can configure an IP address without any computer.

Step 1: Reboot the ET-87P2/4/8 at Run mode

Make sure the switch is set to the “Run” position before you boot up the ET-87P2/4/8.

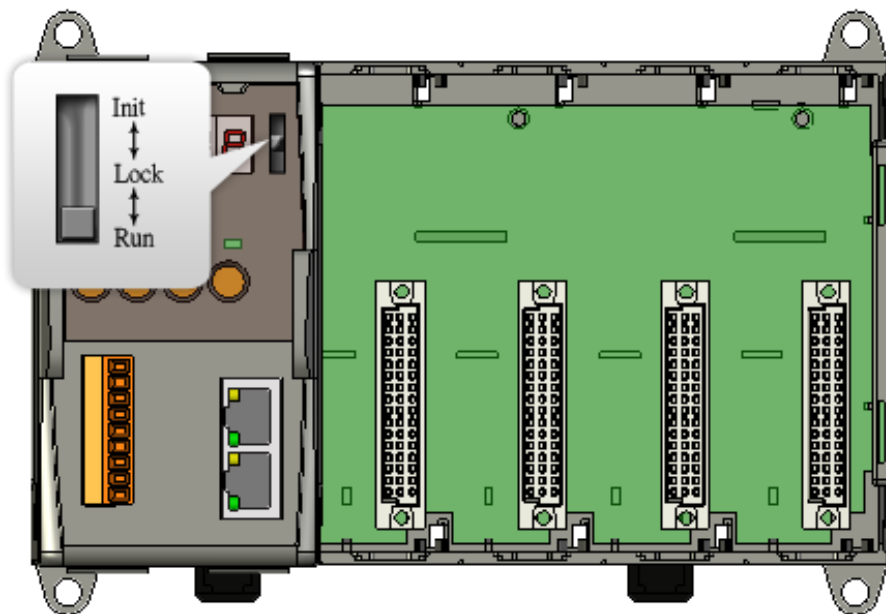

Step 2: Push MODE button to entry control and then use control buttons to configure IP address

Entry control

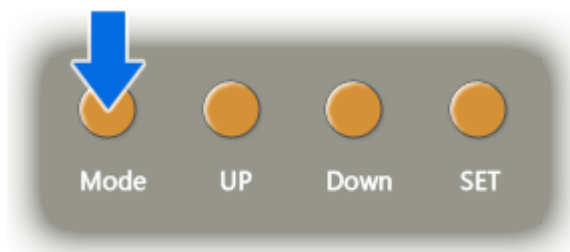

After push the Mode button, then start configure the IP settings and remote I/O port number.

In this case, the LED displays show the IP address as 192.168.255.1 and the port number as 9999.

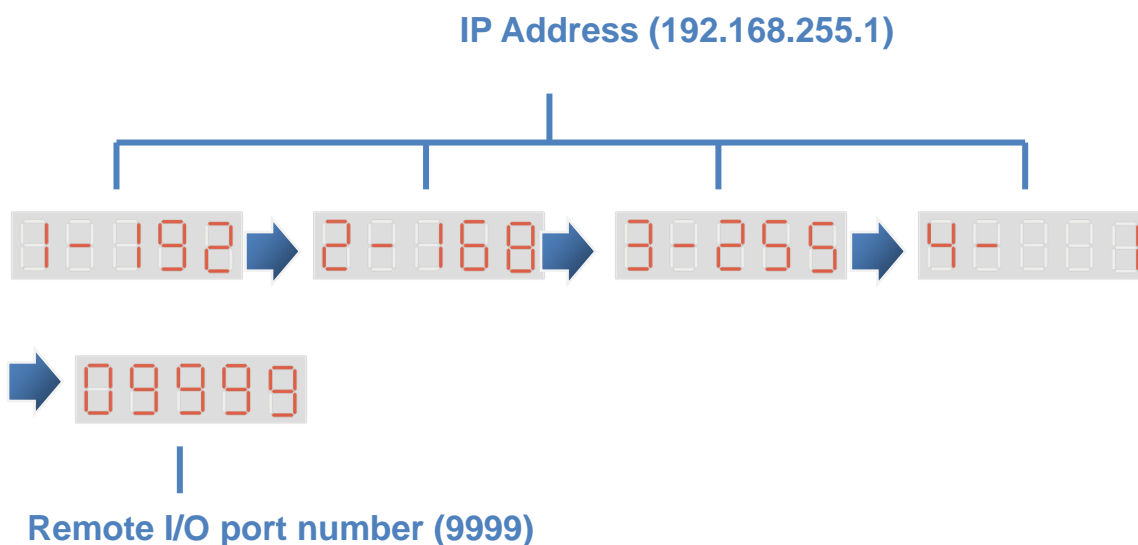

Control buttons description

- **MODE:** Skip to the configure the subnet mask
- **UP:** Increase the value
- **DOWN:** Reduce the value
- **SET:** Save the configuration and skip to the next point

After completing the IP address and port number configuring the port number, please push the MODE button to skip to configure the subnet Mask.

In this case, the LED displays show the subnet Mask as 255.255.0.0.

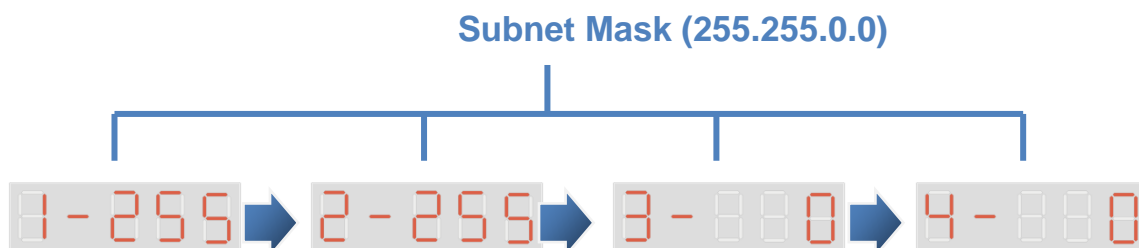

Control buttons description

- **MODE:** Skip to the configure the gateway
- **UP:** Increase the value
- **DOWN:** Reduce the value
- **SET:** Save the configuration and skip to the next point

After completing the mask configuring the port number, please push the MODE button to skip to configure the subnet Mask.

In this case, the LED displays show the Gateway as 192.168.0.1.

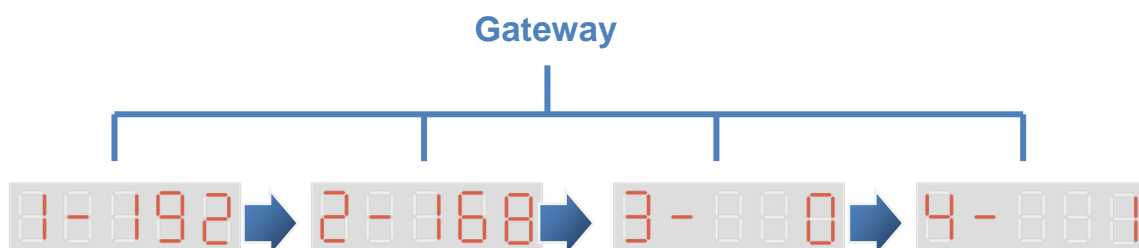

Control buttons description

- **MODE:** Skip to the configure the gateway
- **UP:** Increase the value
- **DOWN:** Reduce the value
- **SET:** Save the configuration and skip to the next point

Step 3: Stop the action and wait a while until 5-digital 7-SEG LEDs automatically shows the IP settings

Stop the action about ten seconds, the settings will be changed and displayed in 5 digital LEDs twice.



Step 4: Push the SET button to check the IP settings

If you don't have to check the IP settings, you just push the SET button, the 5 digital LEDs will show the IP settings twice.

2.6. Creating Virtual COM Ports Using VxComm Utility

The ET-87P2/4/8 is equipped with two Ethernet ports. You can be sent and received RS-232 series data across the Ethernet ports by creating virtual COM ports..

Step 1: Run the VxComm Utility



Double-click the VxComm Utility shortcut on your desktop.

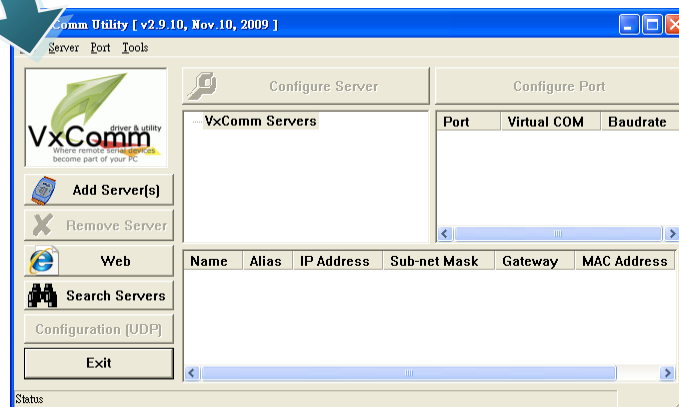

Step 2: Press “Search Servers” button from the toolbar

After pressing Search Servers from toolbar, that will search all of your network modules.

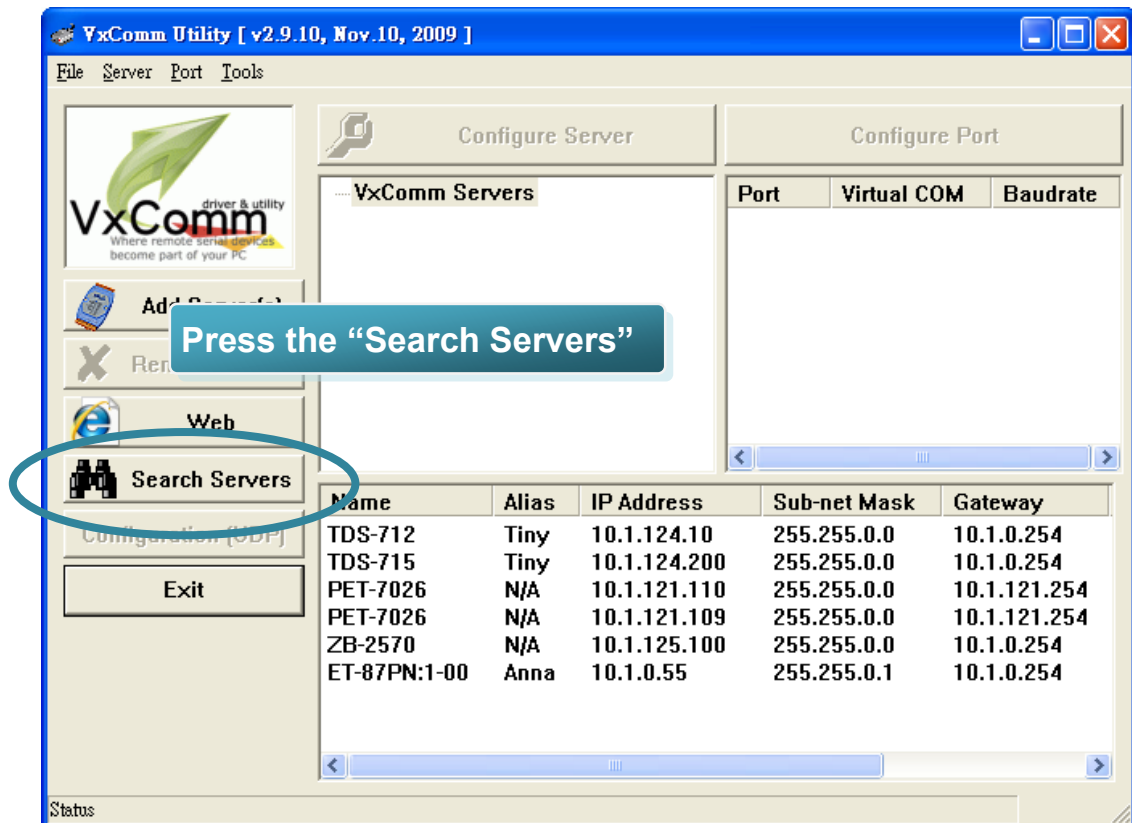

Step 3: Choose the IP Address field you specified easier and press “Add Server(s)” button from the toolbar

Choose the IP Address field you specified in the list, and then press Add Server(s) from the toolbar.

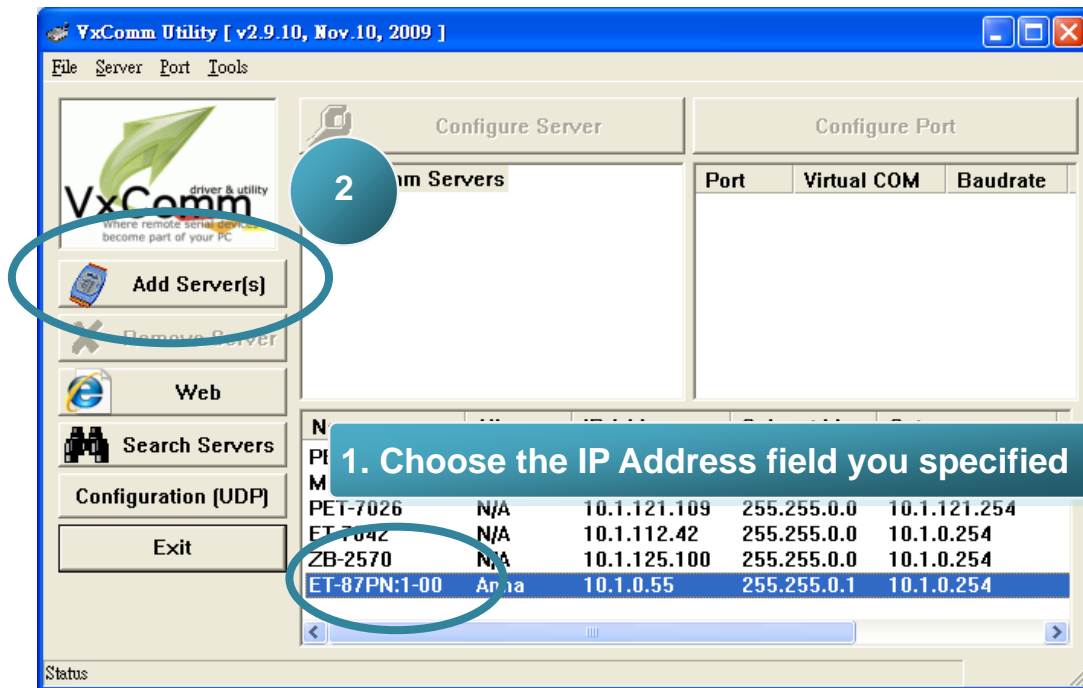

Step 4: Choose the Valid COM Port number you wish to use

After choosing Add Server(s) , the Adding Servers dialog box will appear, and then do the following in this order:

- i. Choose the valid COM Port
- ii. Check the “Maps virtual COM ports to “Port I/O” on servers”
- iii. Click OK button

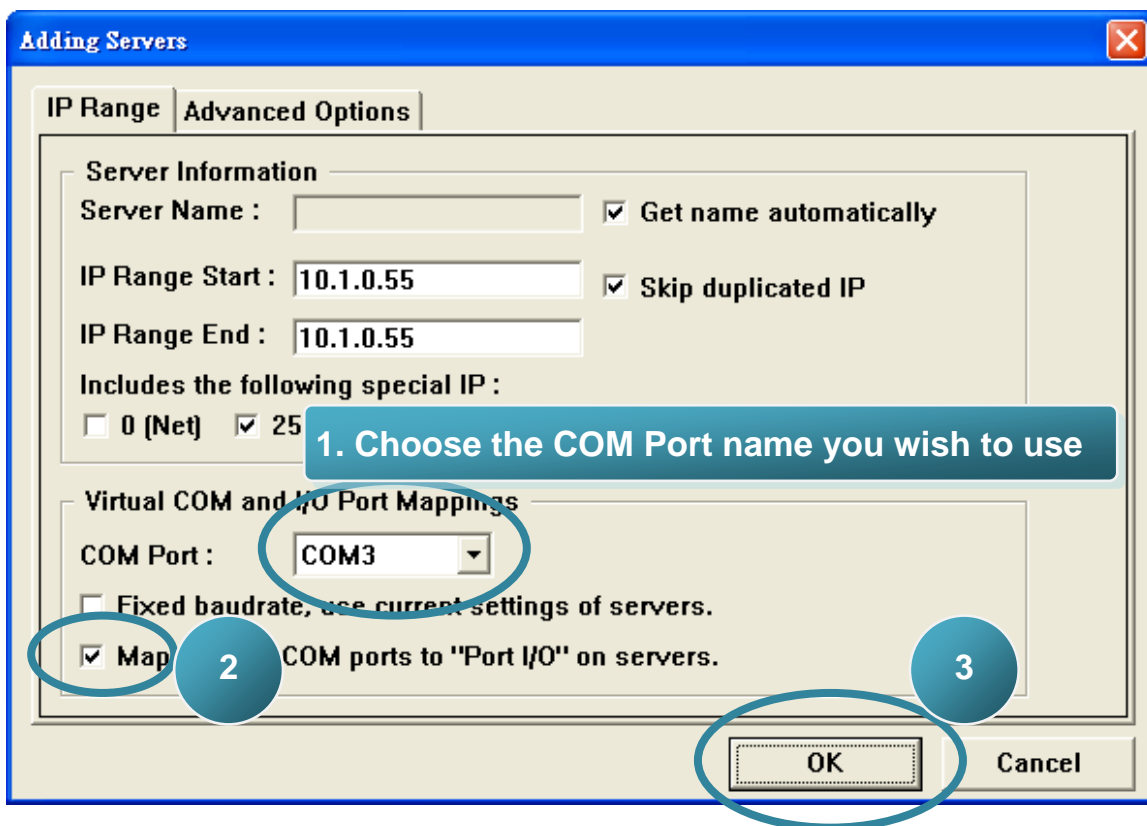

Step 5: Press “Exit” button form the toolbar and then restart the driver

After completing the settings, press Exit button to restart the driver for effecting the settings.

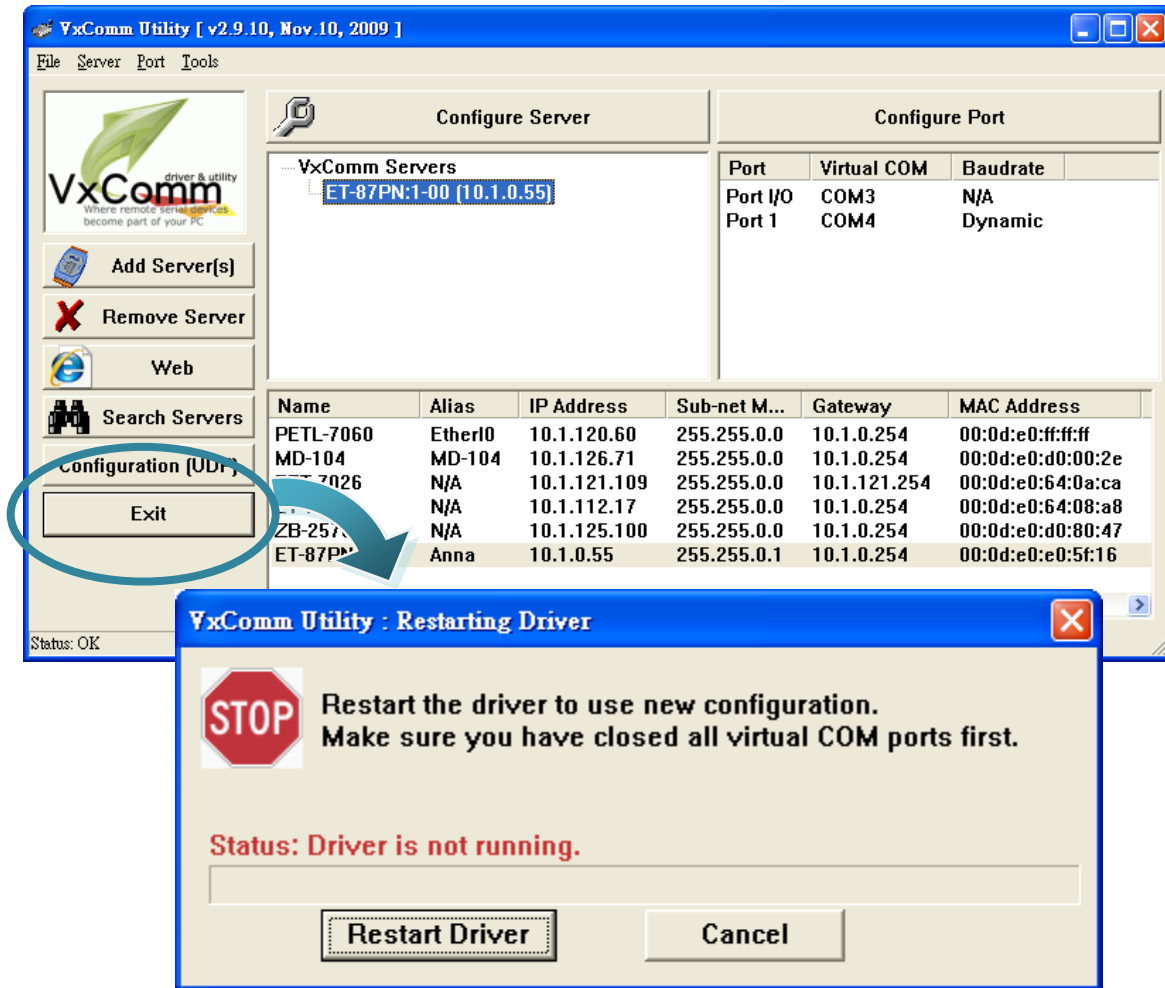

2.7. Establishing PC to ET-87P2/4/8 Communications

DCON Utility is an easy-to-use I/O configuration Utility. Before configuring any I/O settings, you need first establish a connection between ET-87P2/4/8 and PC.

Step 1: Run the DCON Utility



Double-click the DCON Utility shortcut on your desktop.

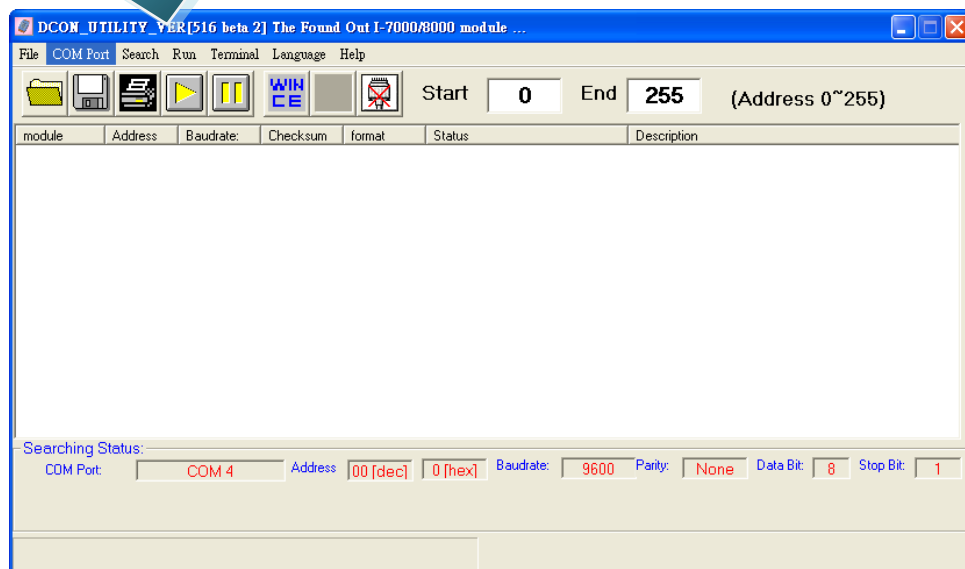

Step 2: Press “COM Port” from the menu to configure the searching parameters

After pressing COM Port from the menu, a dialog will appear, to configure the searching parameters as follows:

Form	Parameter
COM to search	As name you created by VxComm Utility
Baud Rate Option	Any baud rate options you can choose
Checksum Option	Disable
Parity Option	None (N,8,1)



Step 3: Press “  ” from the toolbar

After pressing  from toolbar, that will search all modules are available.

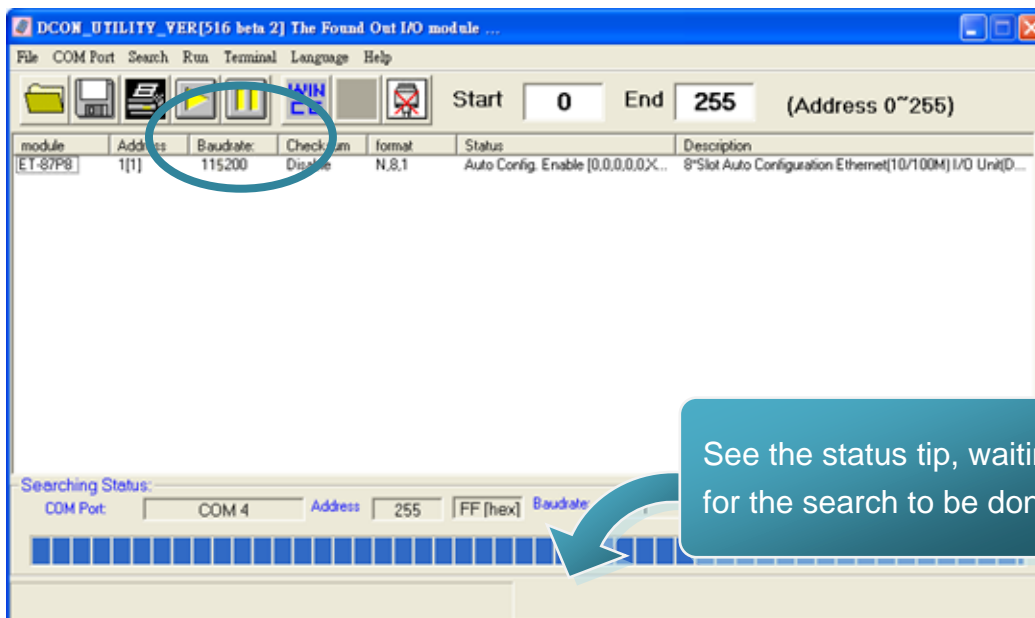

Step 4: The connection has been successfully completed

After the search has been done, the name of the ET-87P2/4/8 will display in the list. The address of the ET-87P2/4/8 is always the 1.

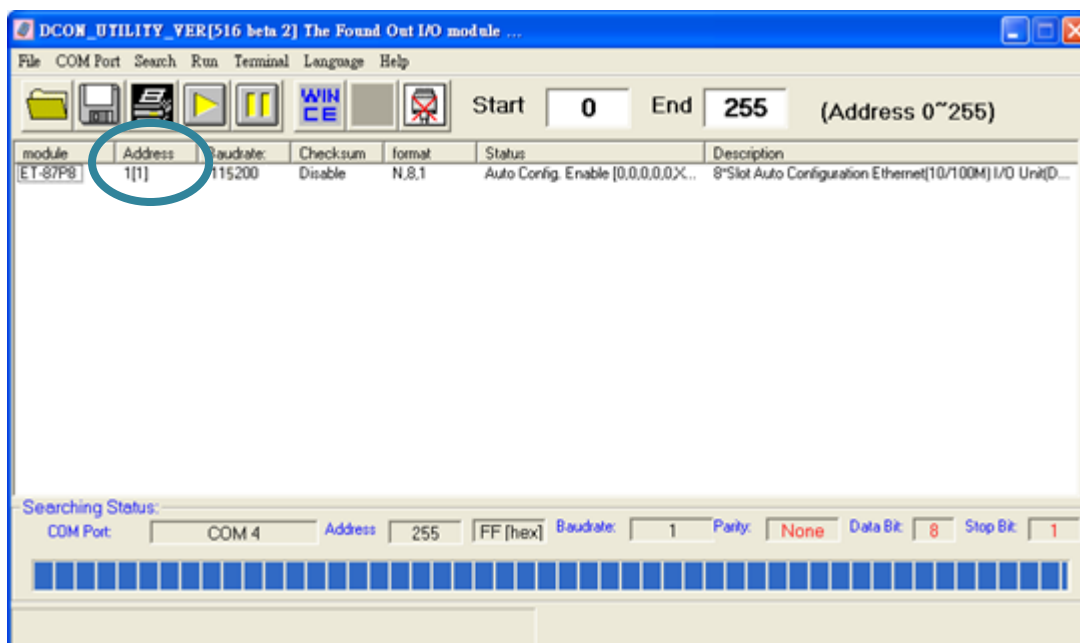

3. I/O Configuration

The ET-87P2/4/8 automatically detects any installed I/O modules at power up.

Before communicating with the I/O module, we must first create the I/O configuration to ET-87P2/4/8 for initiating the I/O modules.

For more information on how to create the I/O configuration, please refer to “3.1. Creating the I/O Configuration”

The status of the I/O configuration

The LED displays can be used to indicate the status of the I/O configuration. By this feature, you can detect the indicator position of the displayed element is shown below.

For more information about the fault message of the I/O slots, please refer to “3.2.1. Fault Message Display”

S (n) represents the slot number. (Slot 0 ~ Slot 7)

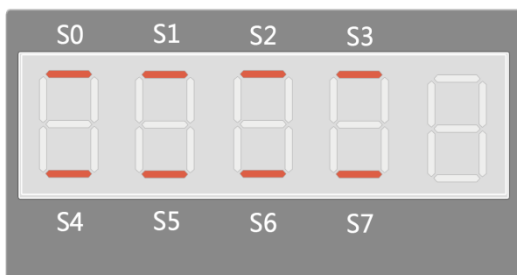

- After Inserting the I/O module, the status of the I/O configuration will start flashing until the I/O configuration is correctly written to ET-87P2/4/8.
- If the I/O configuration fails, the status of the I/O configuration will always on.

3.1. Creating the I/O Configuration

DCON Utility is easy-to-use tool that allows user to automatically check and configure all of I/O configurations.

Step 1: Establishing a connection between the ET-87P2/4/8 and PC

For more detailed information about this process, please refer to section “2.7. Establishing a connection between ET-87P2/4/8 and PC using DCON Utility”

Step 2: Click the name of the ET-87P2/4/8 from the list and then choose the “Configure Module”

After clicking the name of the ET-87P2/4/8 from the list, a dialog will appear, then choose the “Configure Module” button

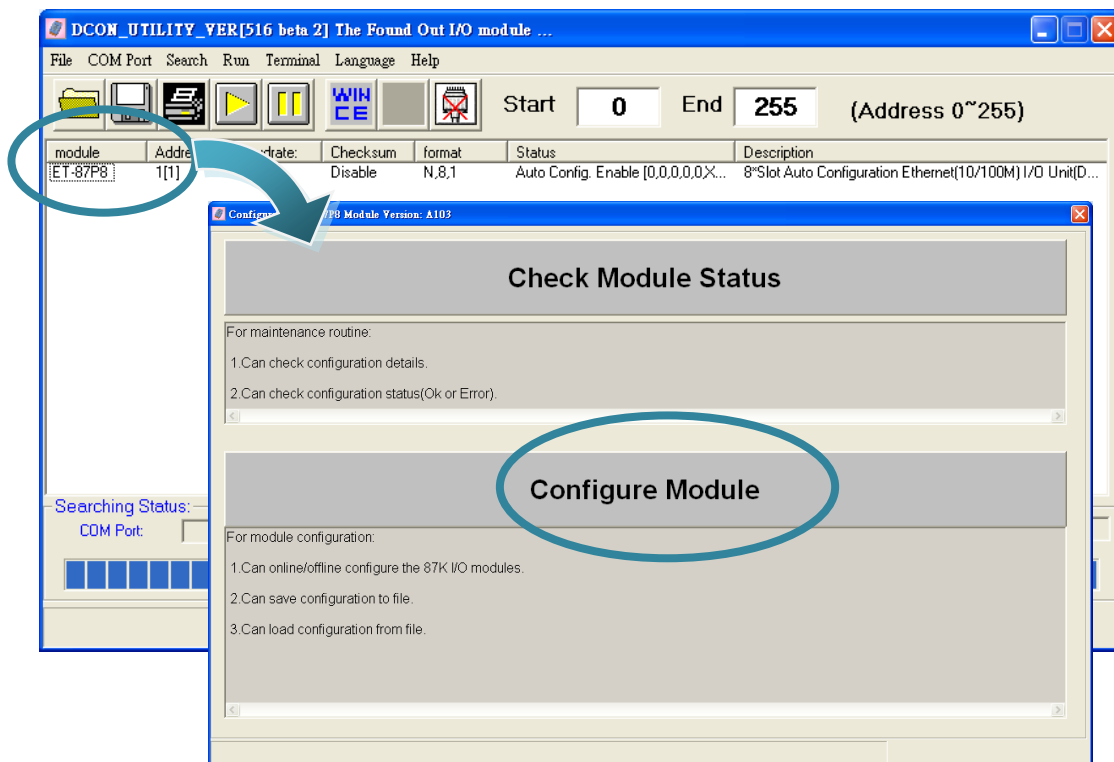

Step 3: Choose “Set As Scanned” button

After choosing Configure Module button, the configuration form will appear, and display all found I/O module, then choose the Set As Scanned button to define the found I/O module.

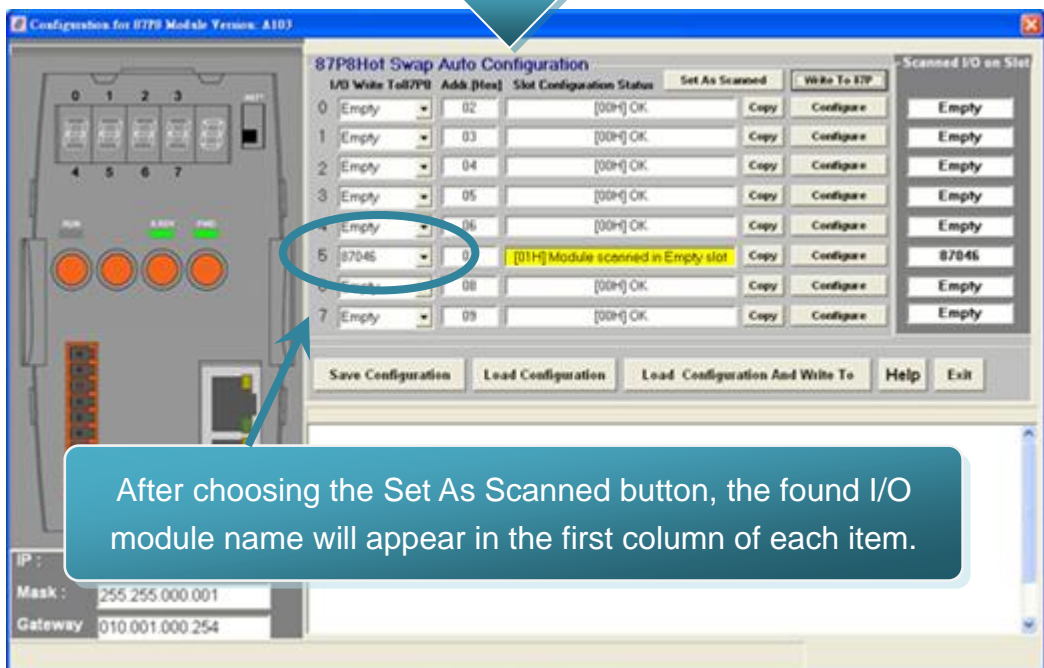
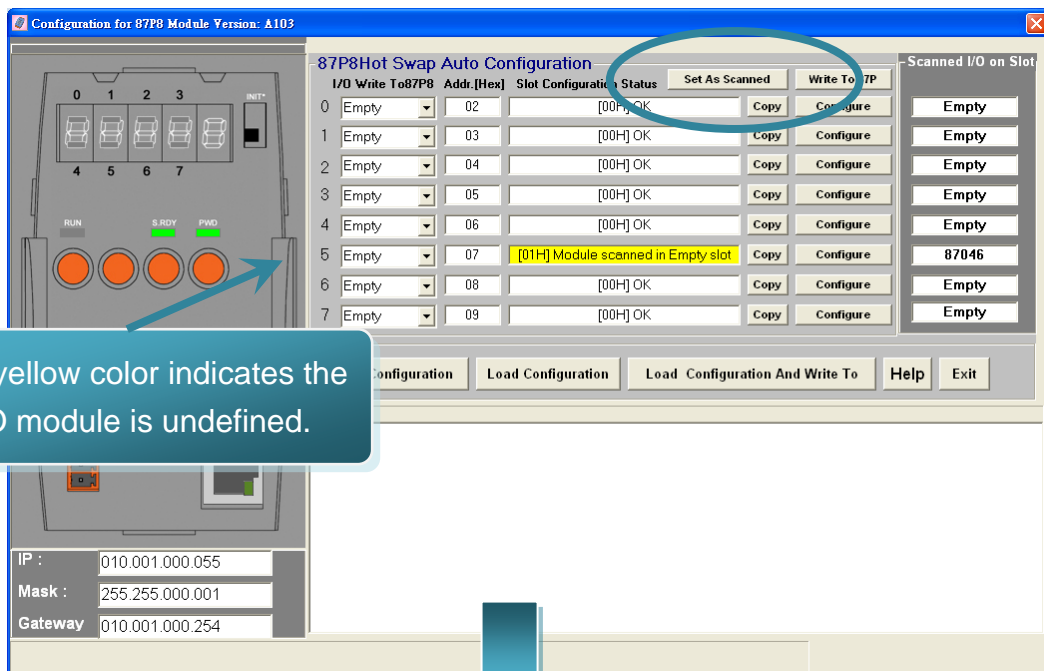

Step 4: Choose “Configuration” button

After choosing the Set As Scanned button, then you can click the configuration button of each found I/O module to configure the I/O module.

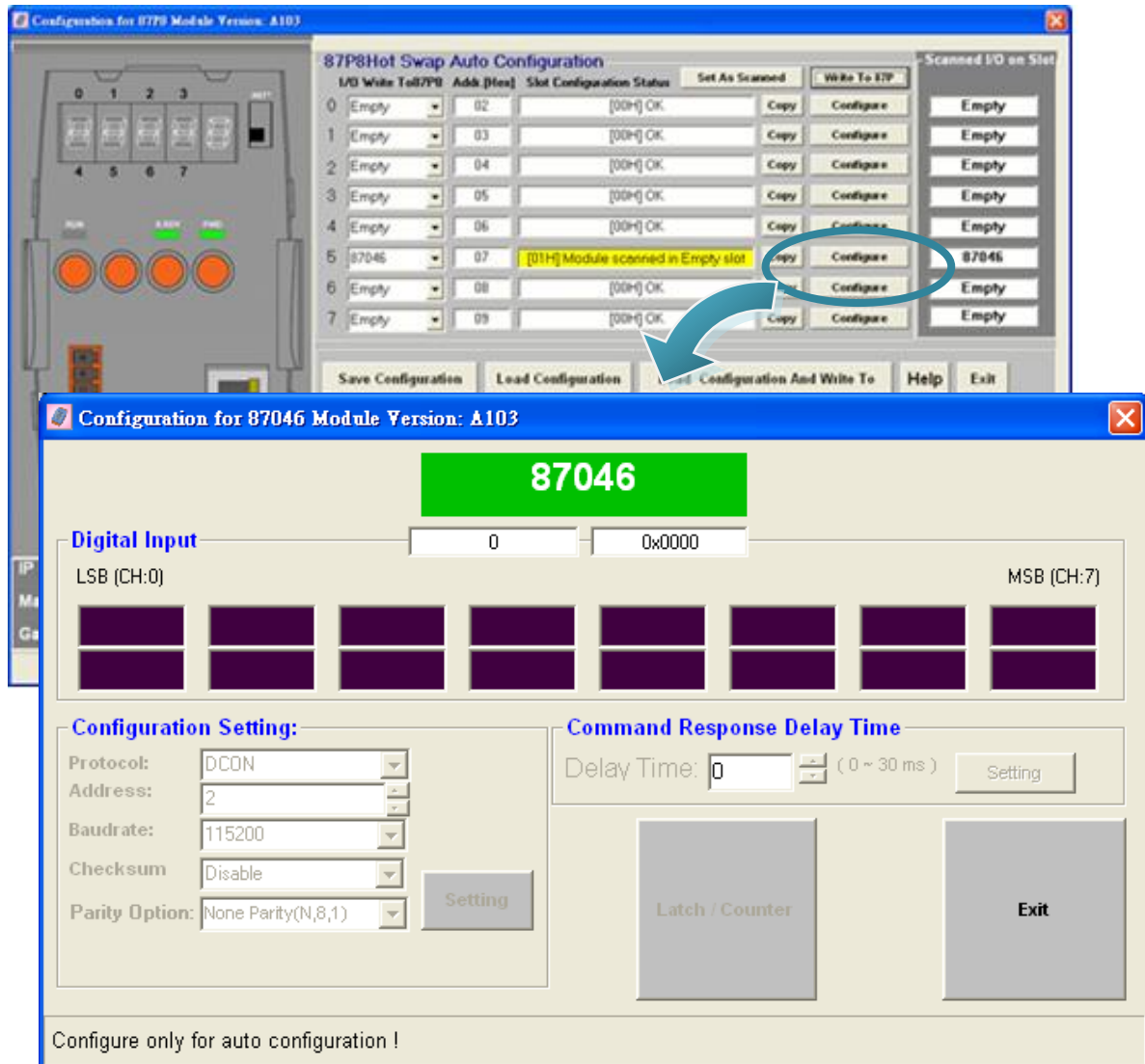

Step 5: Choose “Write To 87P4/8” button

After configuring the I/O module, you must click the Write To 87P4/8 button, then the Warning dialog will appear, and then click Yes button to continue effecting the settings,

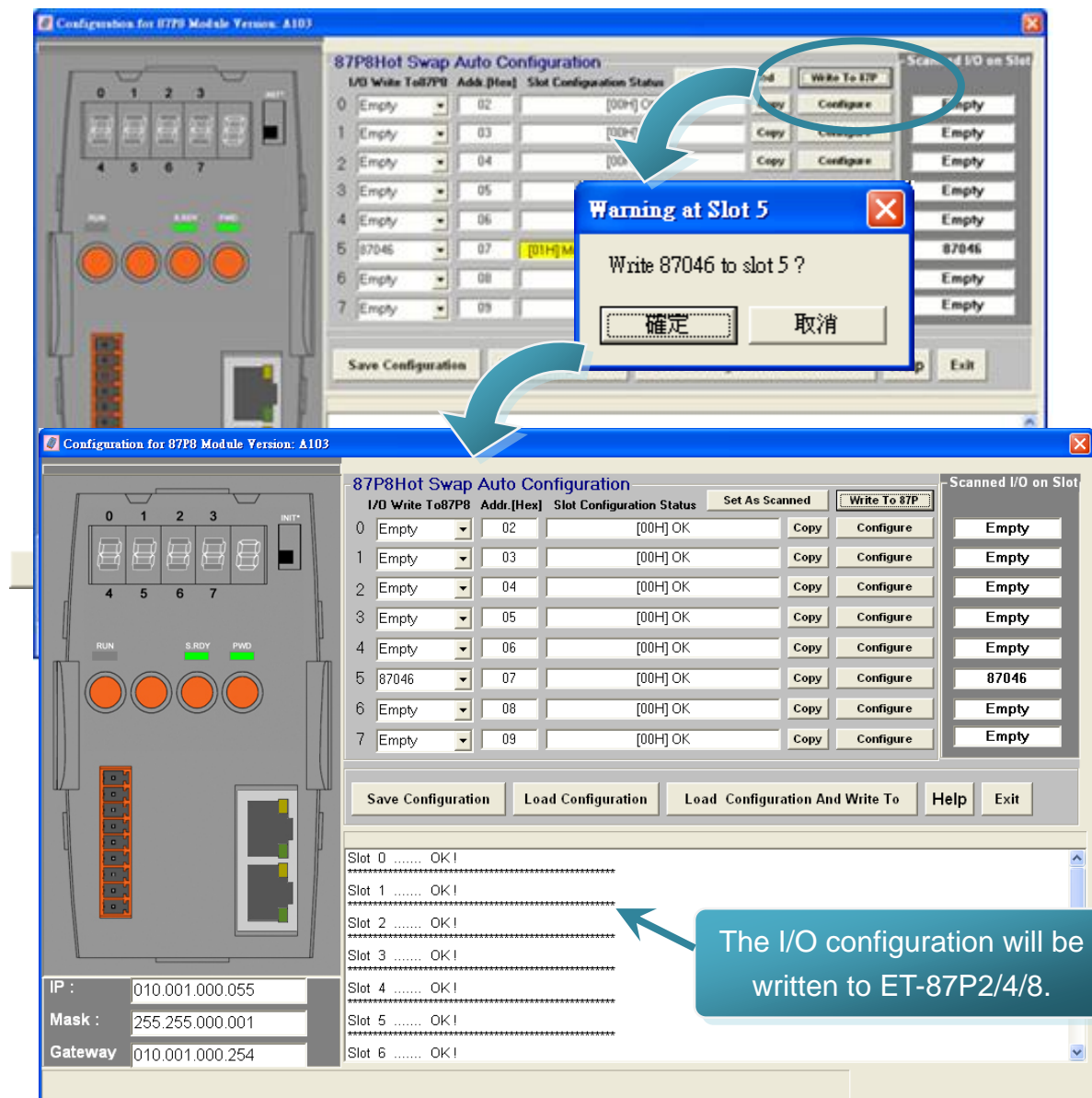

3.2. Checking the I/O Configuration

The monitor mode and the configuration mode are separated in order to prevent the user to accidentally make any changes in settings.

Step 1: Establishing a connection between the ET-87P2/4/8 and PC

For more detailed information about this process, please refer to section “2.7. Establishing a connection between ET-87P2/4/8 and PC using DCON Utility”

Step 2: Choose the name of the ET-87P2/4/8 from the list and then choose the “Check Module Status”

After clicking the name of the ET-87P2/4/8 from the list, a dialog will appear, then choose the “Check Module Status” button

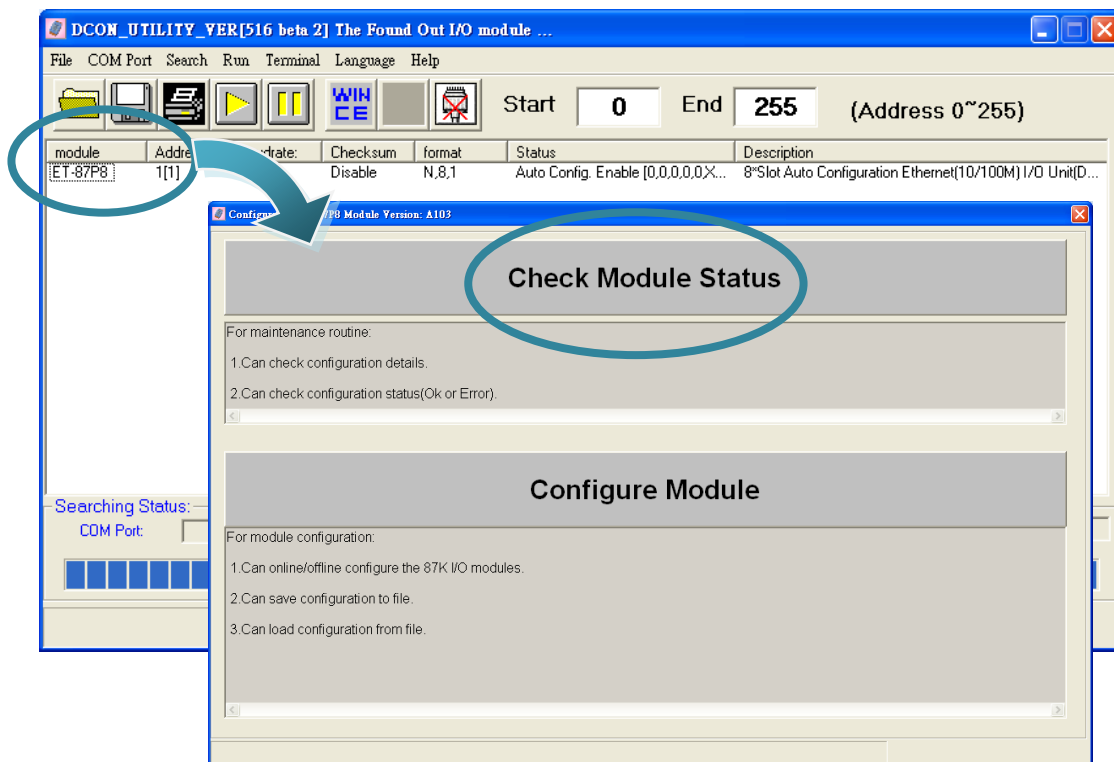

Step 3: Choose “Status” button

After choosing Check Module Status button, a dialog will appear, and display all configured I/O modules, and then choose the status button one of the I/O configuration that you want to monitor.

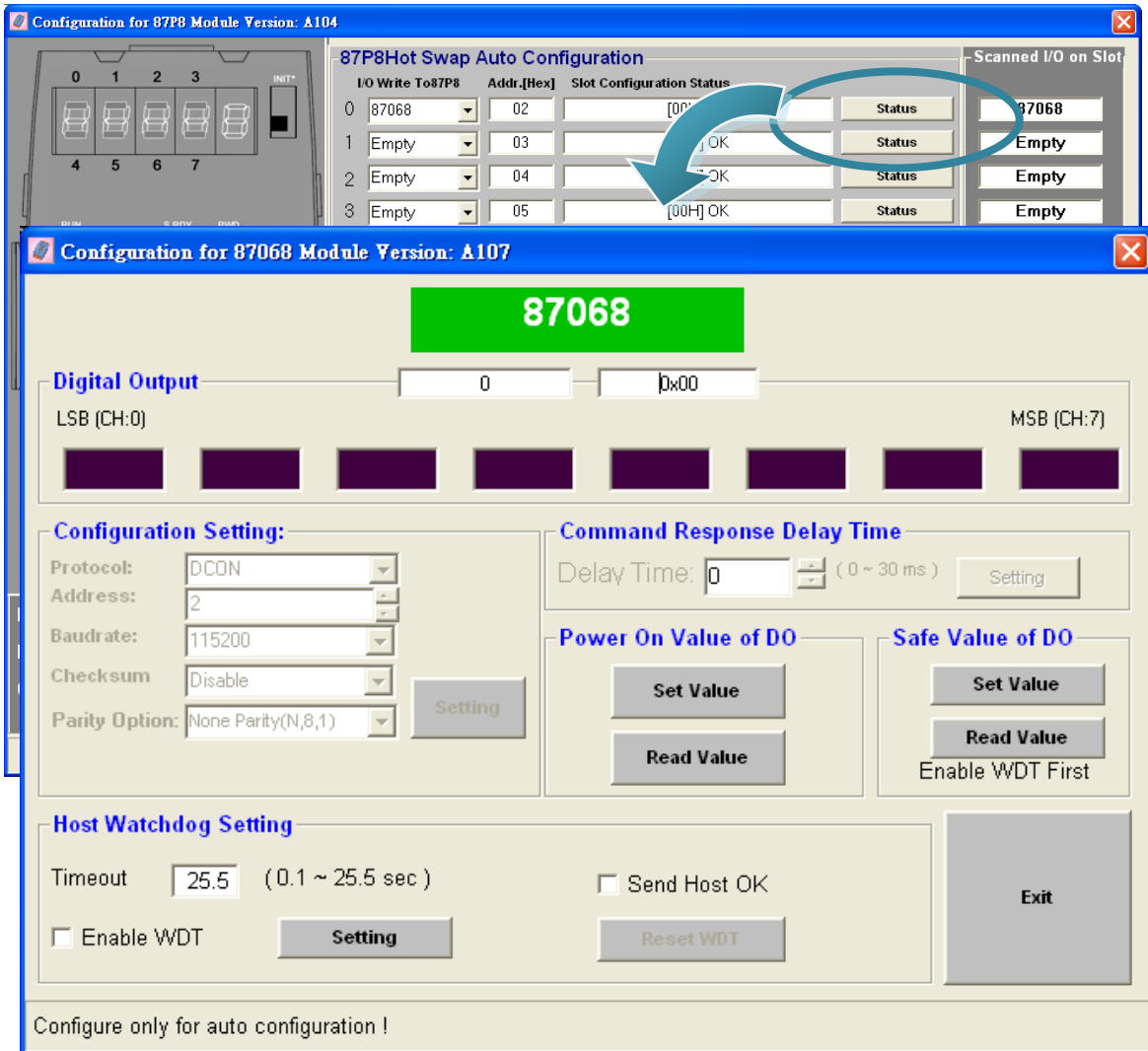

3.3. Backing up/Restore the I/O Configuration

The configuration file is a custom INI file that can be used to backup and restore the ET-87P2/4/8, or import another ET-87P2/4/8.

3.3.1. Backing up the I/O Configuration

After configuring and writing to ET-87P2/4/8, you can saving the configuration. This function can be useful if you need to make backups of ET-87P2/4/8.

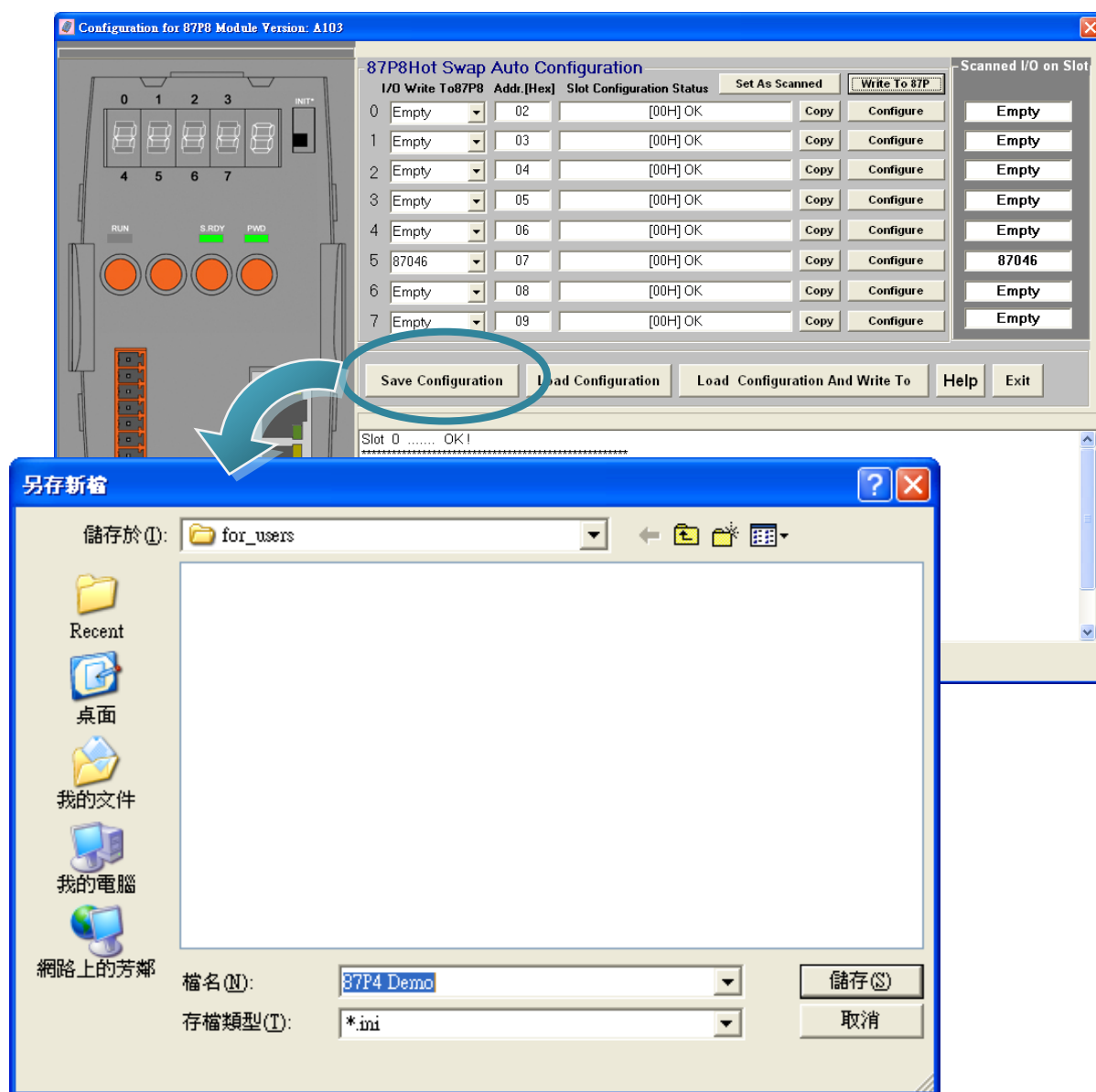

3.3.2. Restoring/Importing the I/O Configuration

Once you have saved a configuration file of the ET-87P2/4/8, you can use this option to restore the ET-87P2/4/8, or import to another ET-87P2/4/8.

Step 1: Choose Load Configuration button

After choosing the Load Configuration button, the Open dialog will appear.

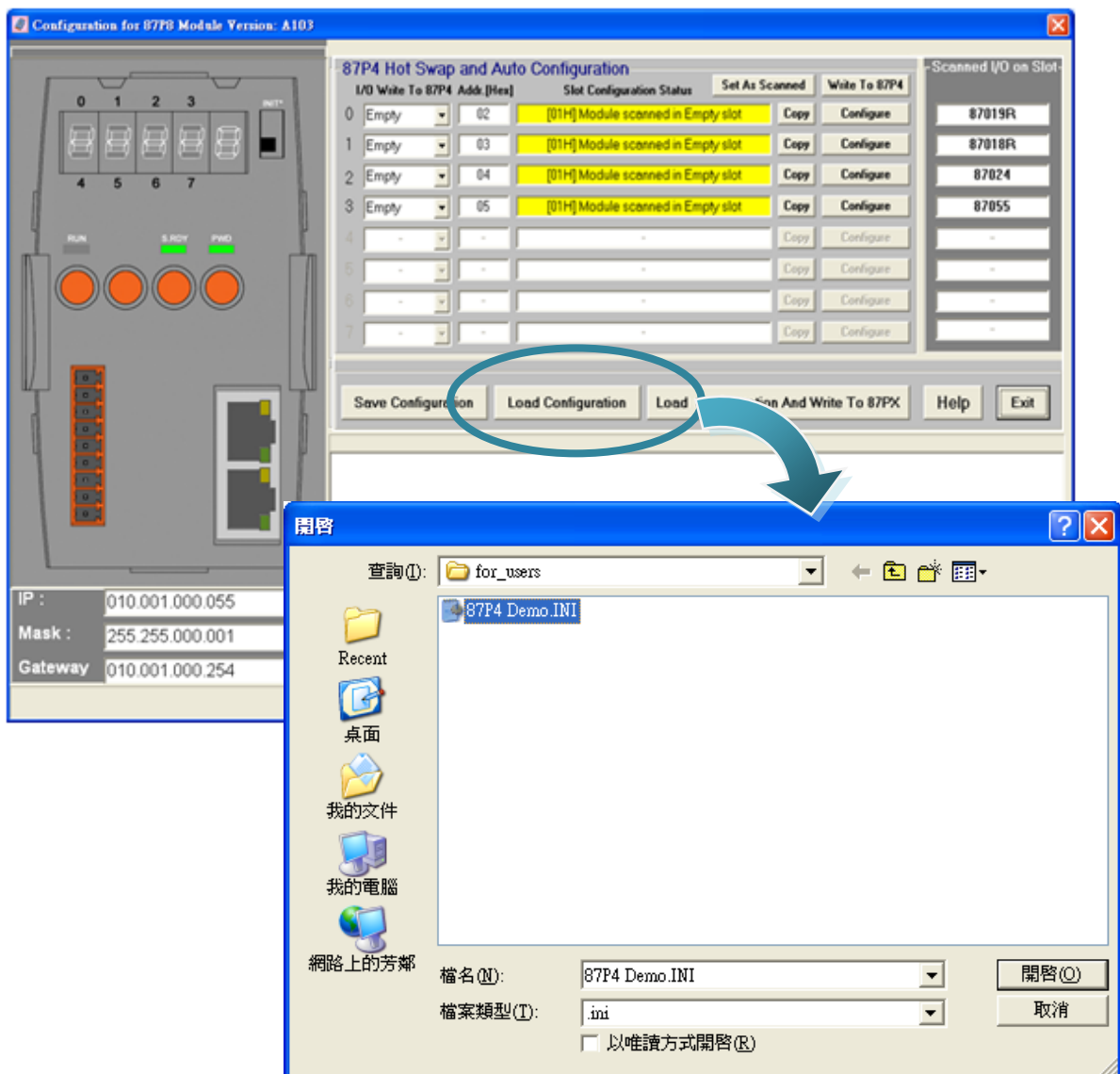

Step 2: Choose the I/O configuration file you wish to use

After choosing the Load Configuration button, the Open will appear, and then select the I/O configuration file you wish to use.

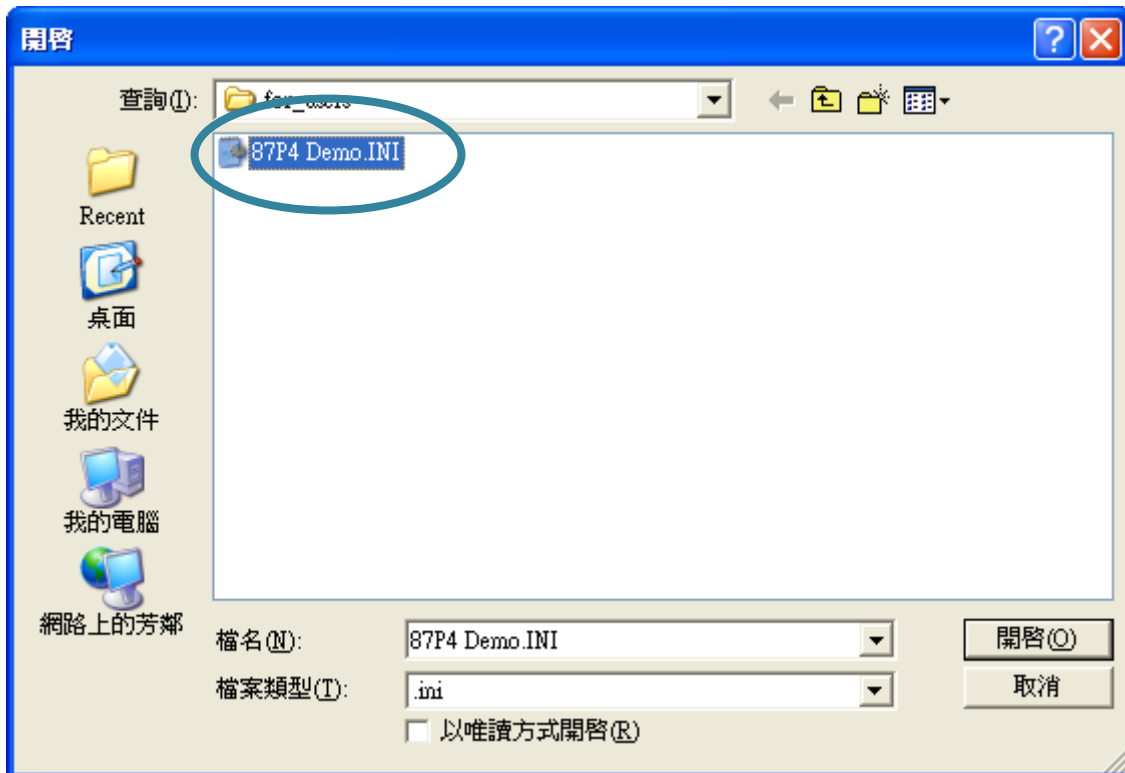

Step 3: The configuration parameters have been loaded successfully

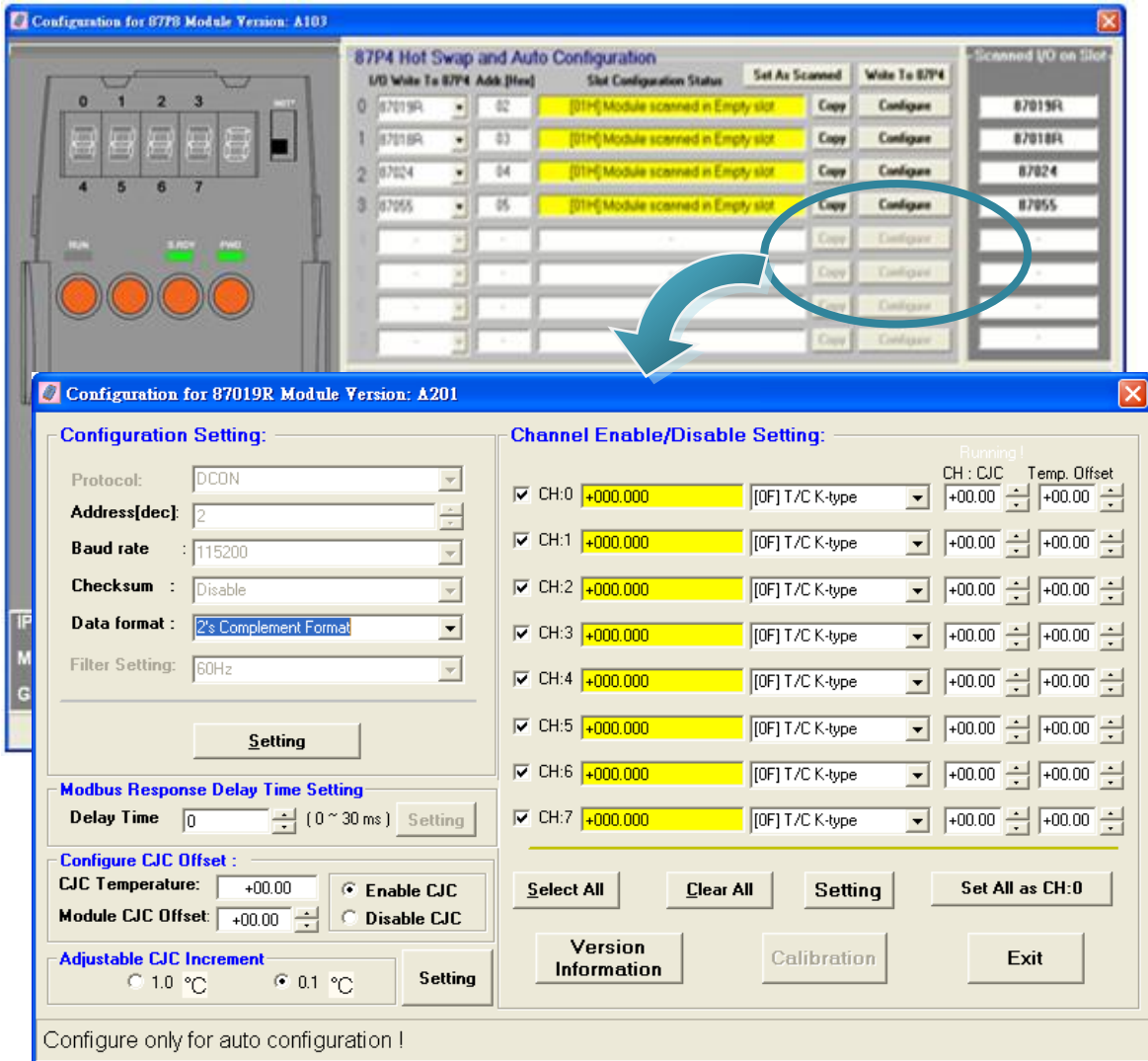

3.3.3. Restoring/Importing the I/O Configuration and Writing to 87P4/8

If you are sure the contents of the configuration file is what you need, here you can simply load the configuration and write to 87Pn at the same time.

Step 1: Choose Load Configuration And Write To 87PX button

After choosing the Load Configuration And Write to 87PX button, the Open dialog will appear.

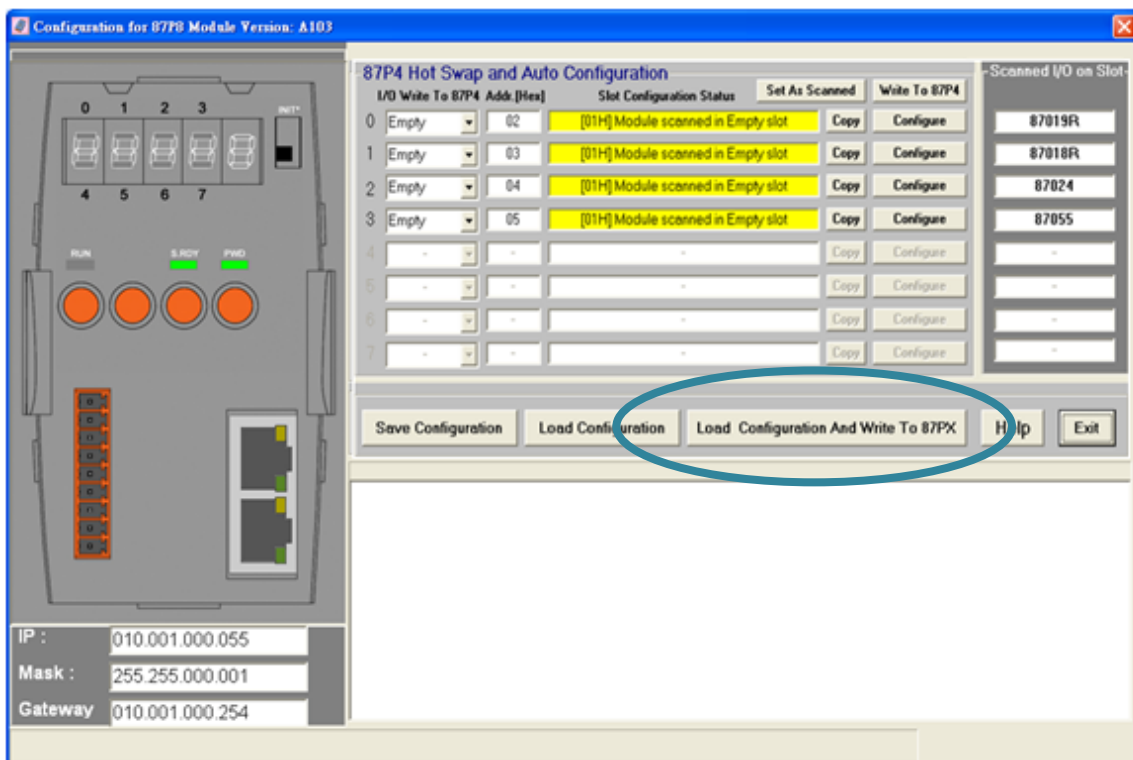

Step 2: Choose the I/O configuration file you wish to use

After choosing the Load Configuration button, the Open will appear, and then select the I/O configuration file you wish to use.

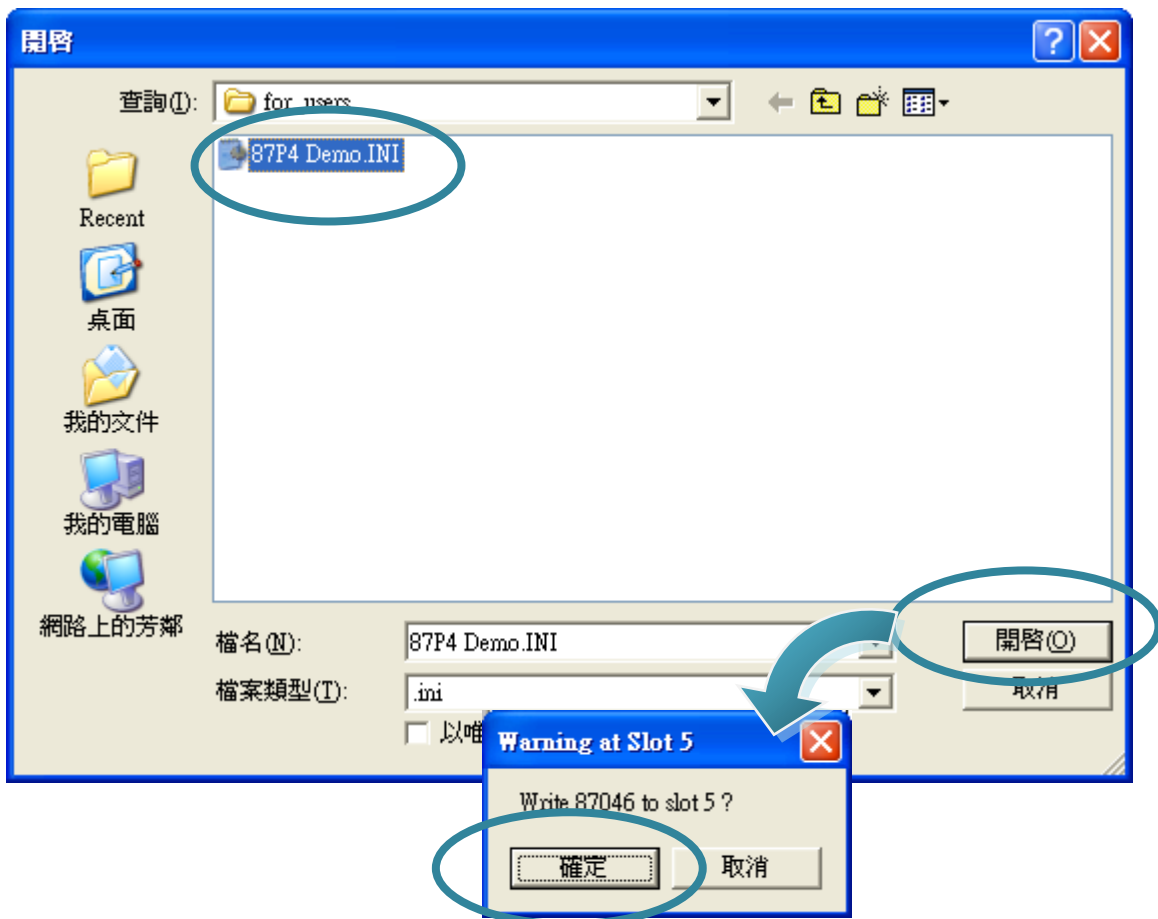

3.4. Saving the I/O Configuration File without ET-87P2/4/8 Online

DCON Utility can save the ET-87P2/4/8 I/O configuration file without connect ET-87P2/4/8 and any I/O modules. You may use this function to create the configuration file. It is convenient for remote support and system backup.

Step 1: Press “  ” from the toolbar

After pressing  from toolbar, and then select the Module ID, Address, Baudrate and Checksum.

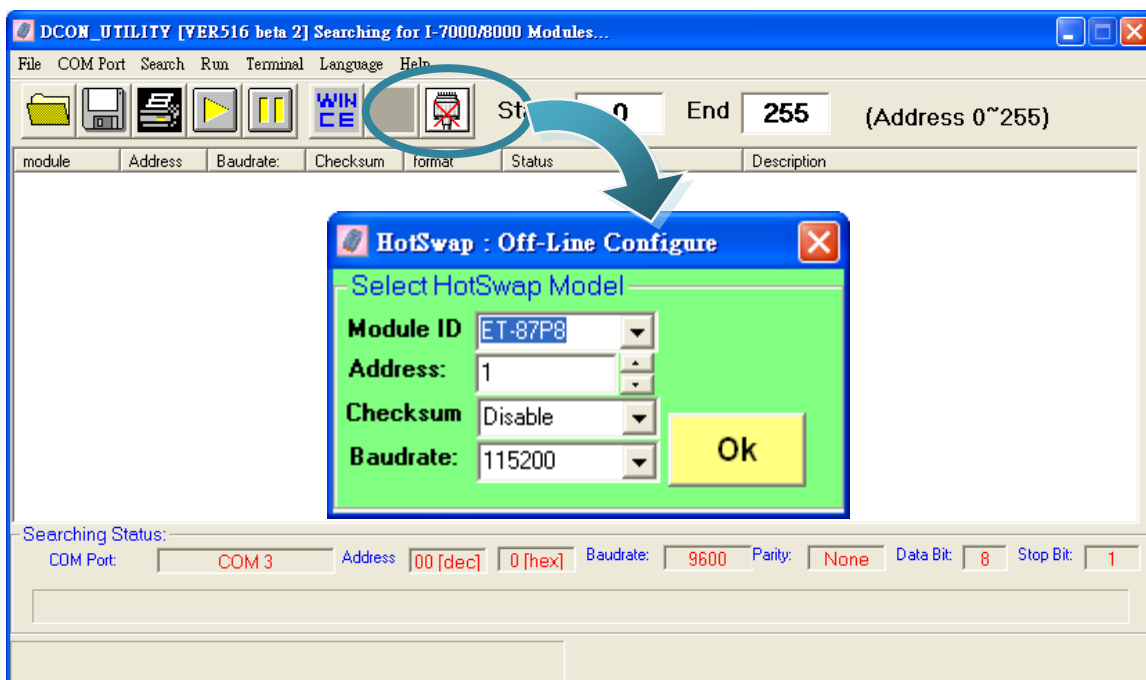

Step 2: Choose the “Configure Module”

After completing the off-line configuration, the I/O Configuration form will appear, and then choose the Configure Module button.

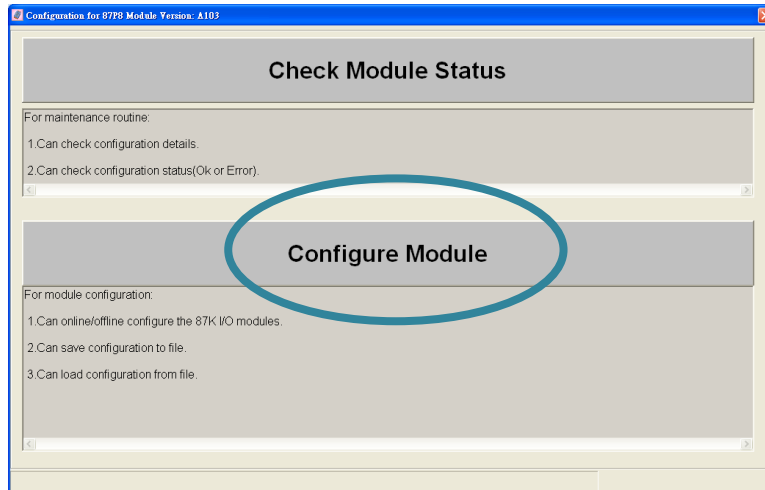

Step 3: Configure the I/O module

Select and configure the I/O module, then save the settings as another file name.

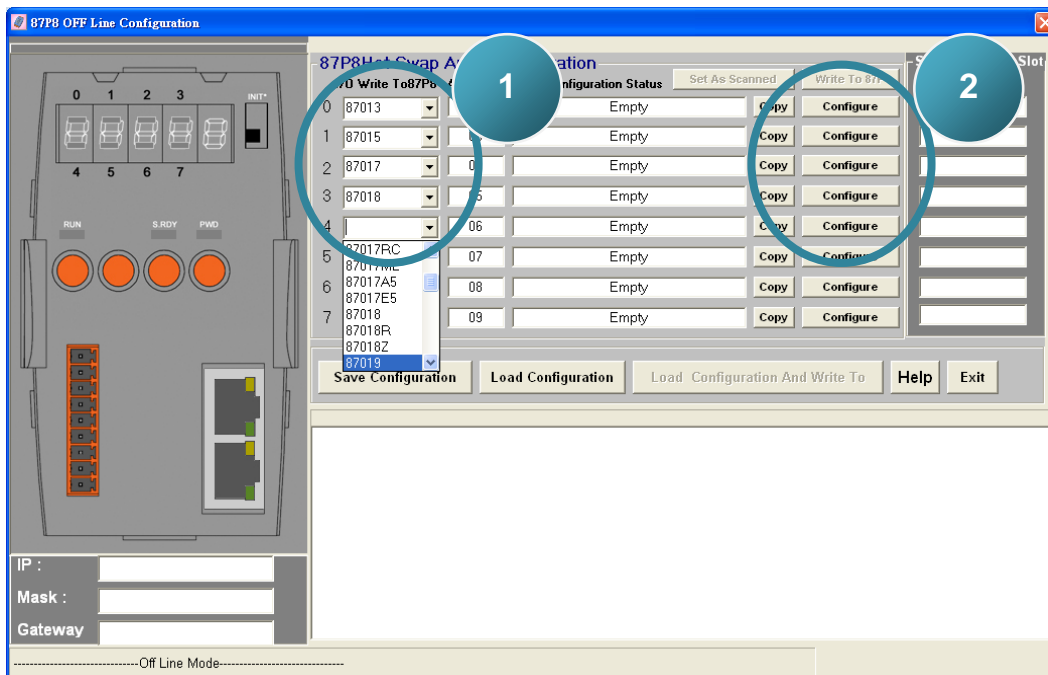

Step 4: Choose “Save Configuration” button

After choosing Save Configuration button, the Save As... dialog will appear, and the type the file name.

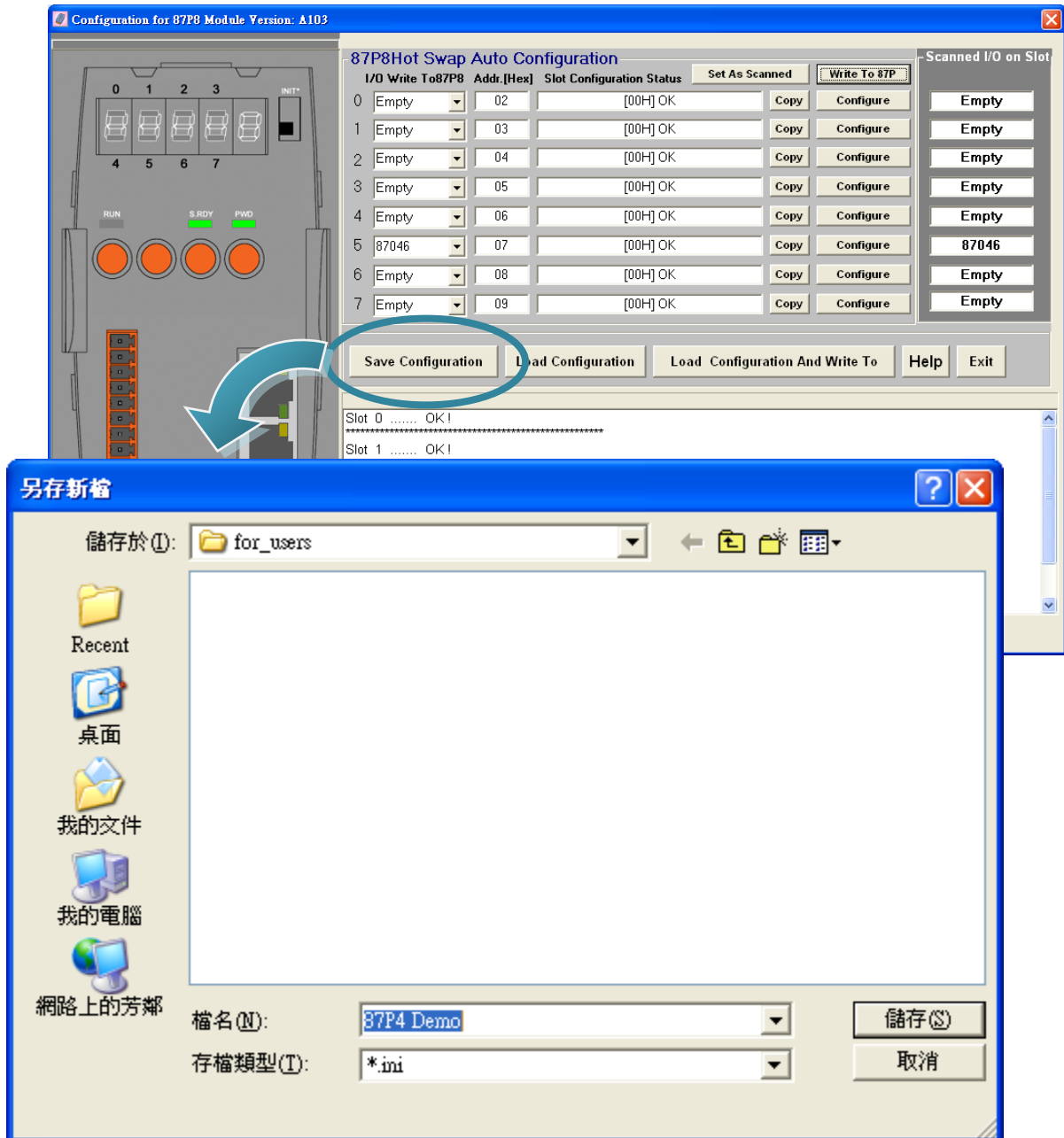

4. Tools and SDKs

This chapter brief describes the function of installed tools and SDKs. All of the tools and SDKs are listed below. deference

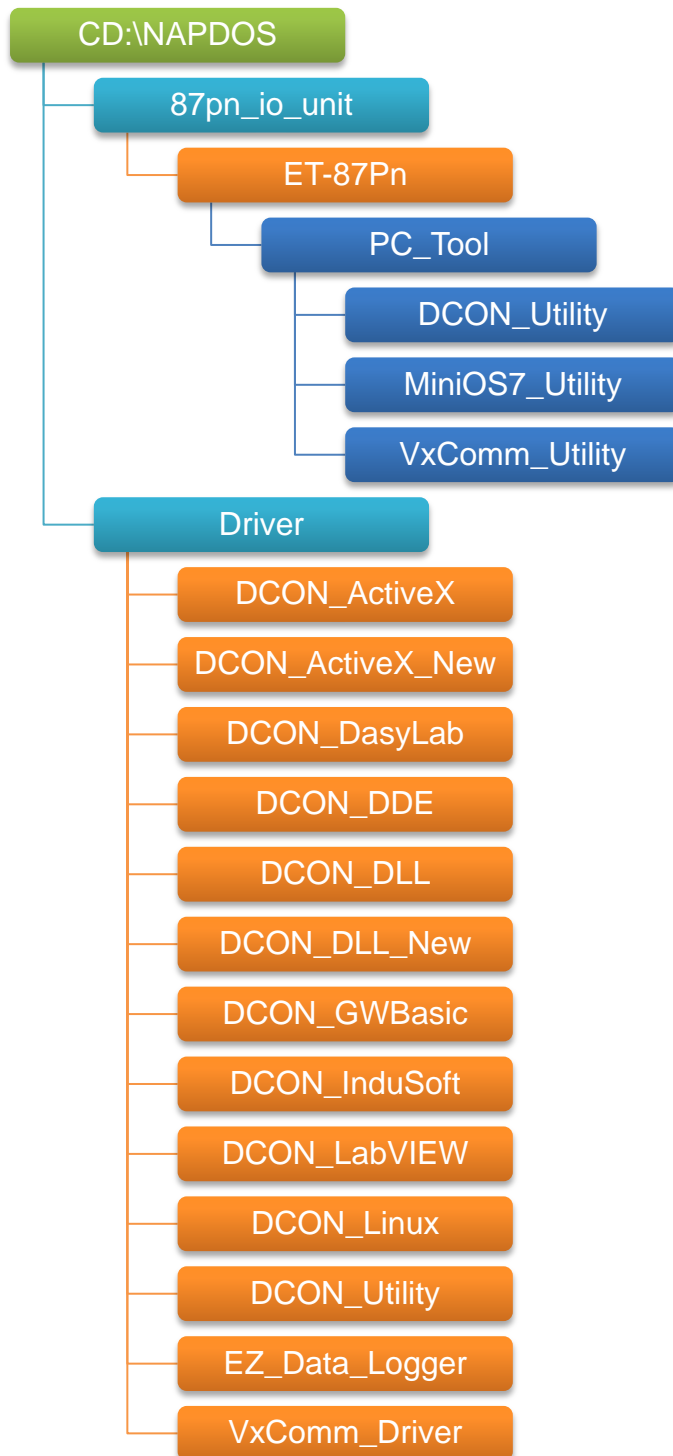

4.1. Tools

There are three main tools for managing the ET-87P2/4/8. All of tools are list below.

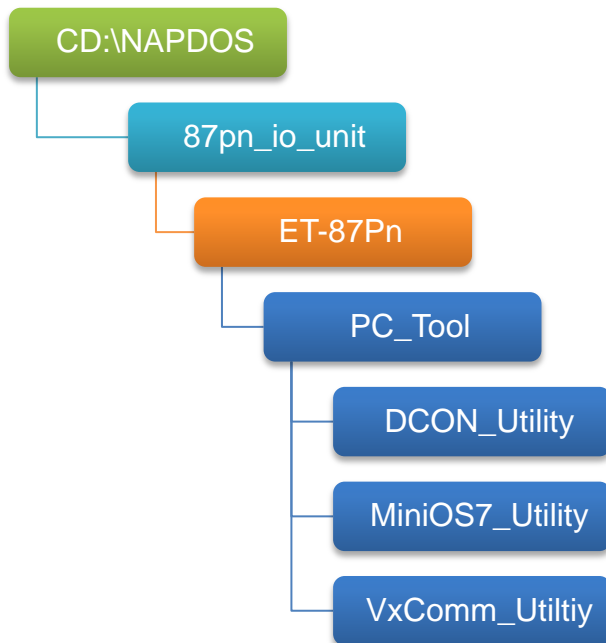

The following lists summarize the functions of these tools.

DCON Utility

- Configure I/O modules (Please refer to 3. I/O Configuration)

MiniOS7 Utility

- Configure IP Address (Please refer to 2.3.2. Assign IP Address)
- Update the OS (Please refer to 4.1.2.2. Updating the ET-87P2/4/8 OS)
- Update the firmware (Please refer to 4.1.2.3. Updating the ET-87P2/4/8 firmware)

VxComm Utility

- Create Virtual COM Ports (Please refer to 2.4.2. Creating Virtual COM Ports)

4.1.1. DCON Utility

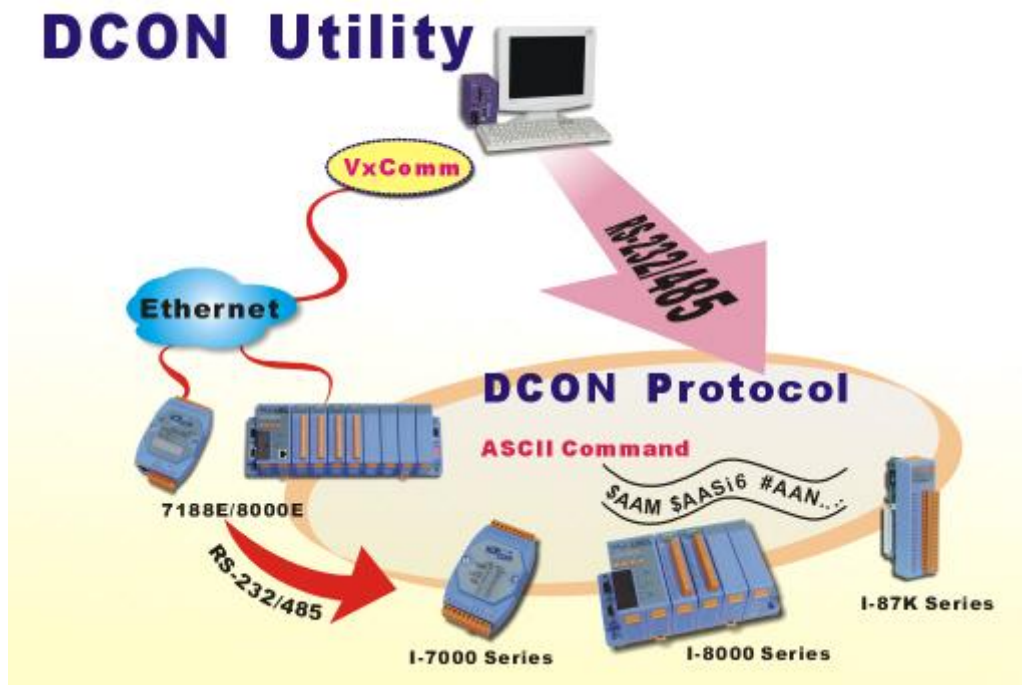

The DCON Utility is a toolkit that help user search the network, easily to Configure the I/O modules and test the I/O status via the serial port (RS-232/485) or Ethernet port (using virtual com port). It supports not only the DCON Protocol I/O modules but also the M Series I/O Modules (Modbus RTU M-7K, M-87K and will support Modbus ASCII M-87K) now.

For more detailed information on DCON Utility applications, please refer to “3. I/O configuration”

For more details, please refer to DCON Utility web site:

<http://www.icpdas.com/products/dcon/introduction.htm>

4.1.2. MiniOS7 Utility

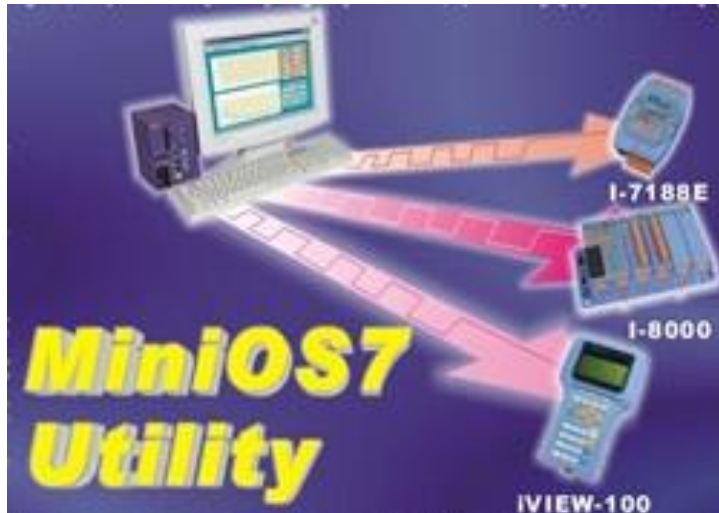

MiniOS7 Utility is a tool for uploading firmware to flash memory and updating the OS to ET-87P2/4/8 module embedded with ICP DAS MiniOS7 with easiness and quickness.

Note: Since version 3.1.1, the Utility can allow users remotely access the controllers (7188E, 8000E, ..., etc) through the Ethernet

For more detailed information on how to using MiniOS7 Utility to assign an IP address, please refer to “2.5.1. Using MiniOS7 Utility to assign a new IP”

For more detailed information on how to using MiniOS7 Utility to update the ET-87P2/4/8, please refer to “5. ET-87P2/4/8 Updates”

4.1.3. VxCOMM Utility



The VxComm Utility is designed for creating virtual COM ports and maps them to the Ethernet port of the ET-87P2/4/8.

Commands and data sending to the virtual COM ports will be redirected to the ET-87P2/4/8's Ethernet ports. And the received data from ET-87P2/4/8's COM ports will also be redirected to PC's virtual COM ports.

For more detailed information on how to create virtual COM ports, please refer to “2.4. Using VxComm Utility to Create Virtual COM Ports”

For more details, please refer to VxComm Utility web site:

<http://www.icpdas.com/products/Software/VxComm/vxcomm.htm>

4.2. SDKs

The ICP DAS SDKs is a set of tools, code samples, documentation, headers, and libraries that users can use to create applications quickly and easily.

All of them are list below.

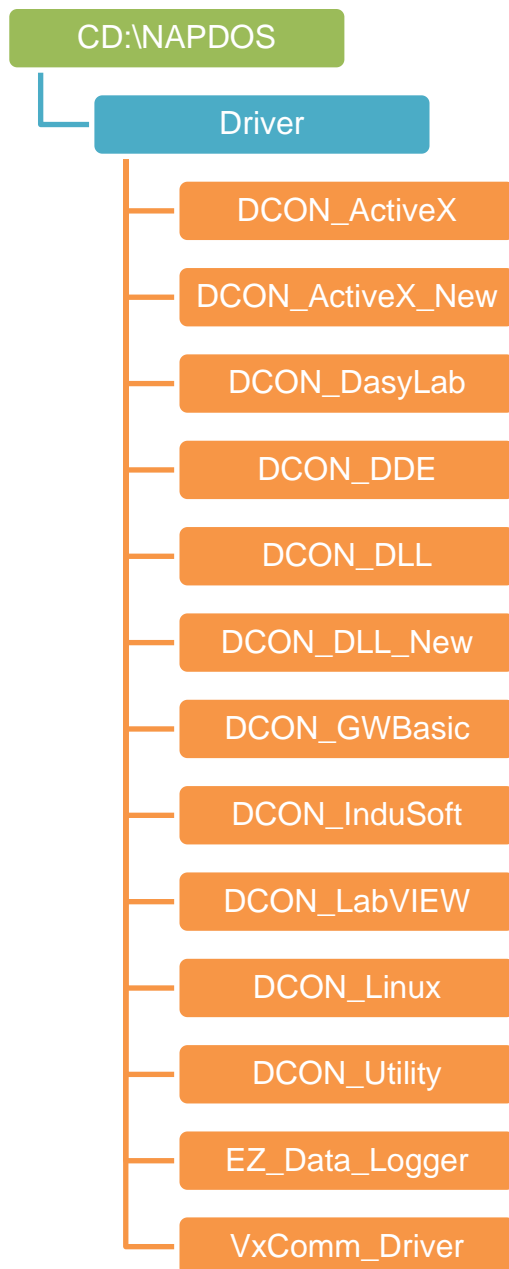

For details of the function and example applications of the ET-87P2/4/8, please refer to:

<http://www.icpdas.com/products/dcon/introduction.htm>

<http://ftp.icpdas.com/pub/cd/8000cd/napdos/driver/>

5. ET-87P2/4/8 Updates

The ET-87P2/4/8 updates can be divided into two classes: OS updates and Firmware updates. Below we will describe how to updating the ET-87P2/4/8.

5.1. OS updates

Step 1: Get the latest version of the MiniOS7 OS image

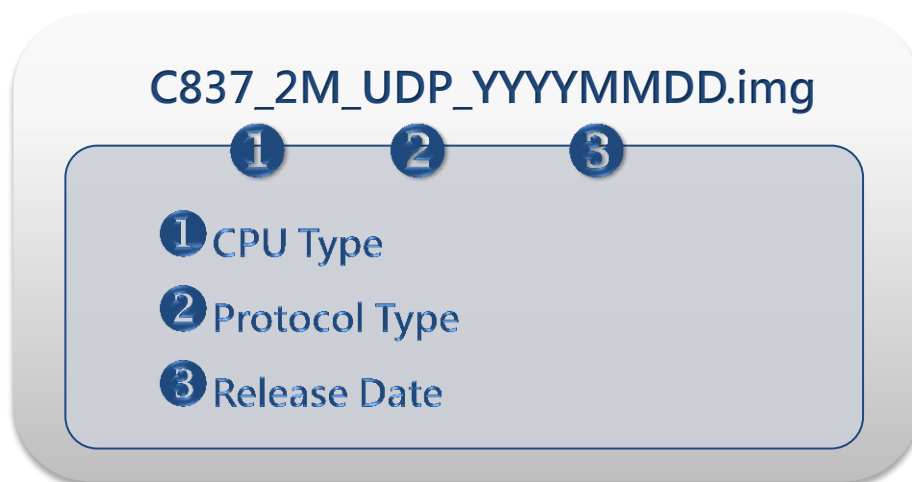

The latest version of the MiniOS7 OS image can be obtained from:

CD:\NAPDOS\87pn_io_unit\ET-87Pn\OS_Image\

ftp://ftp.icpdas.com/pub/cd/8000cd/napdos/87pn_io_unit/et-87pn/os_image/

Step 2: Run the MiniOS7 Utility



Double-click the MiniOS7 Utility shortcut on your desktop.

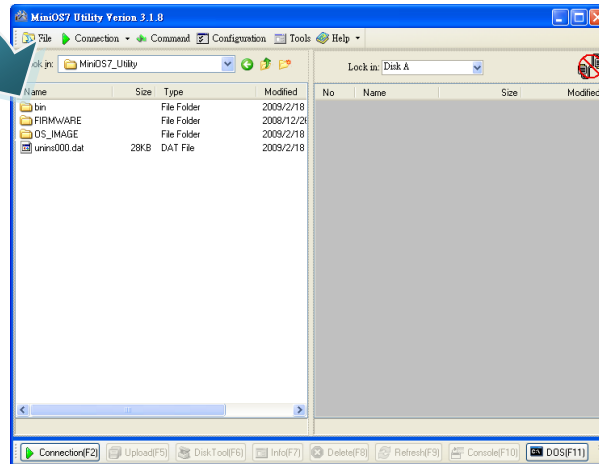

Step 3: Choose "Search" from the "Connection" menu

After choosing Search from Connection menu, that will search all of the MiniOS7 modules on your network.

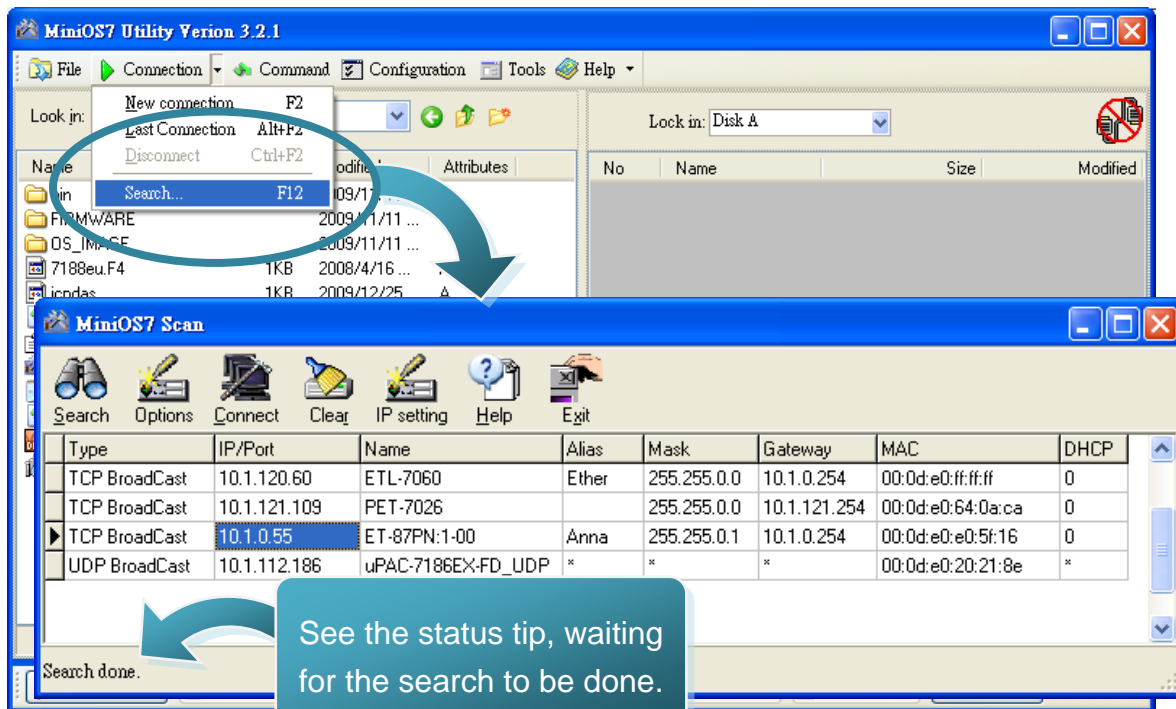

Step 4: Double-Click the field of your ET-87P2/4/8 module

Double-Click the field of your ET-87P2/4/8 module in the list to connect to your ET-87P2/4/8.

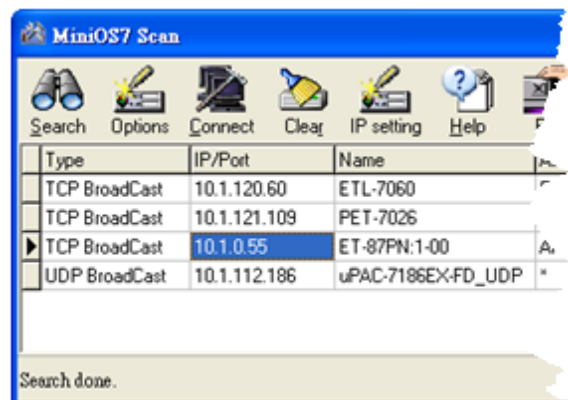

Step 5: The connection has ready been established

Check the connection status in the top right side to make sure the connection has been established

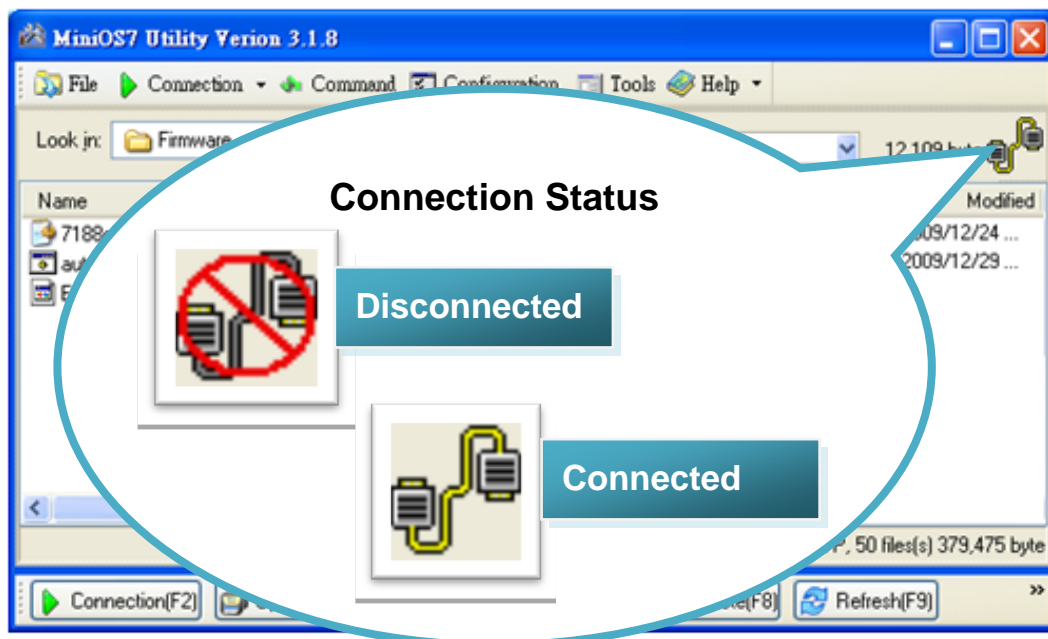

Step 6: Choose “Update MiniOS7 Image” from the “File” menu

After exchanging the protocol, then choose Update MiniOS7 Image from File menu to start the update procedure.

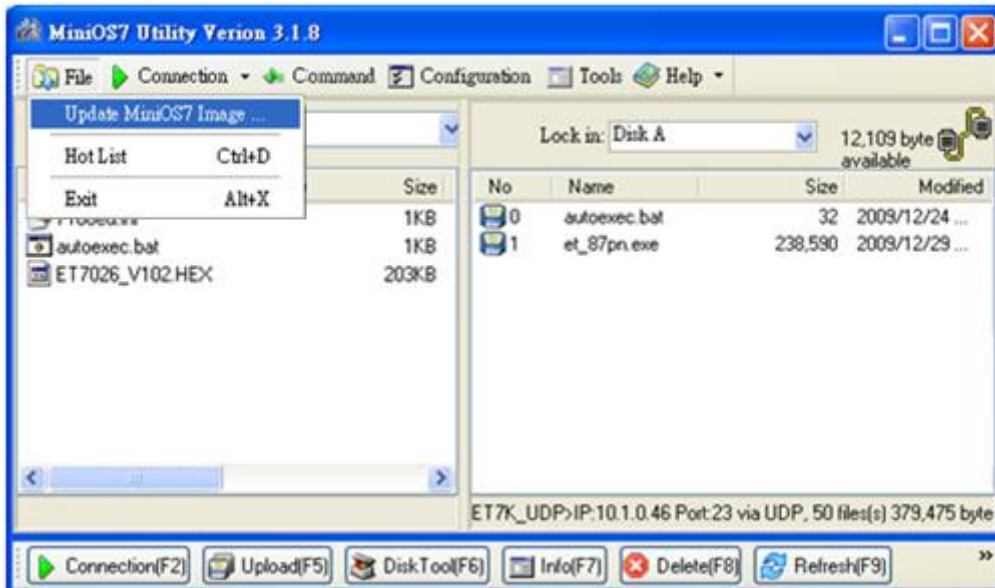

Step 7: Select the latest version of the MiniOS7 OS image

After choosing the update MiniOS7 Image command, the Select MiniOS7 Image file will appear, and then select the latest version of the MiniOS7 OS image.

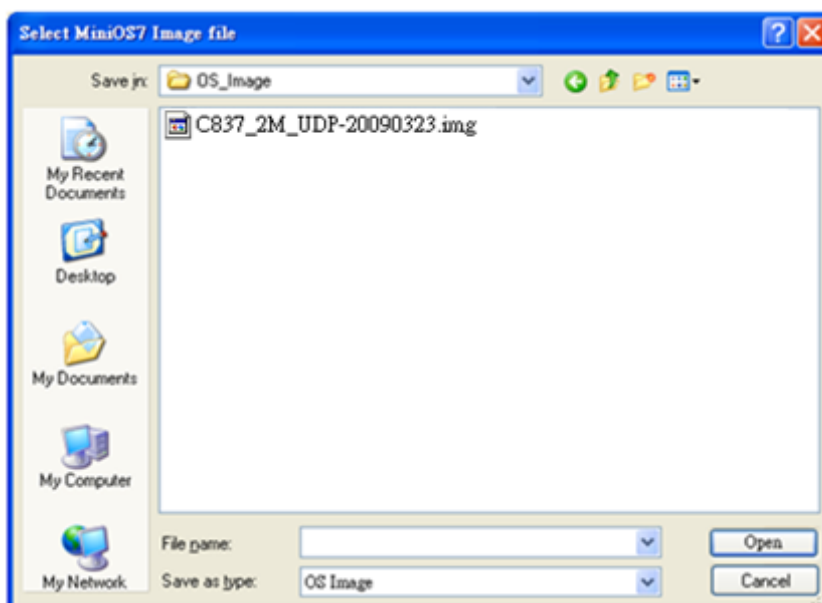

Step 8: Click “OK” to finish the procedure

After confirming the command, you just need to wait awhile until the following dialog appear, and then click OK button to finish the procedure.

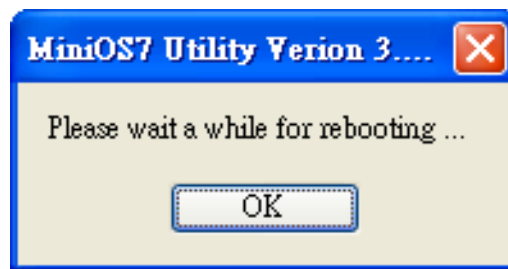

Step 9: Restart the MiniOS7 Utility and establish a connection

You may need to restart the MiniOS7 Utility for refreshing the settings, and then establishing a connection.

For more detailed about this process, please refer to section “4.1.2.1. Establishing a Connection” to establish a connection.

Step 10: Choose “Info” from the “Command” menu to check the OS version

After pressing F7 or choosing info from Command menu to check the OS version.

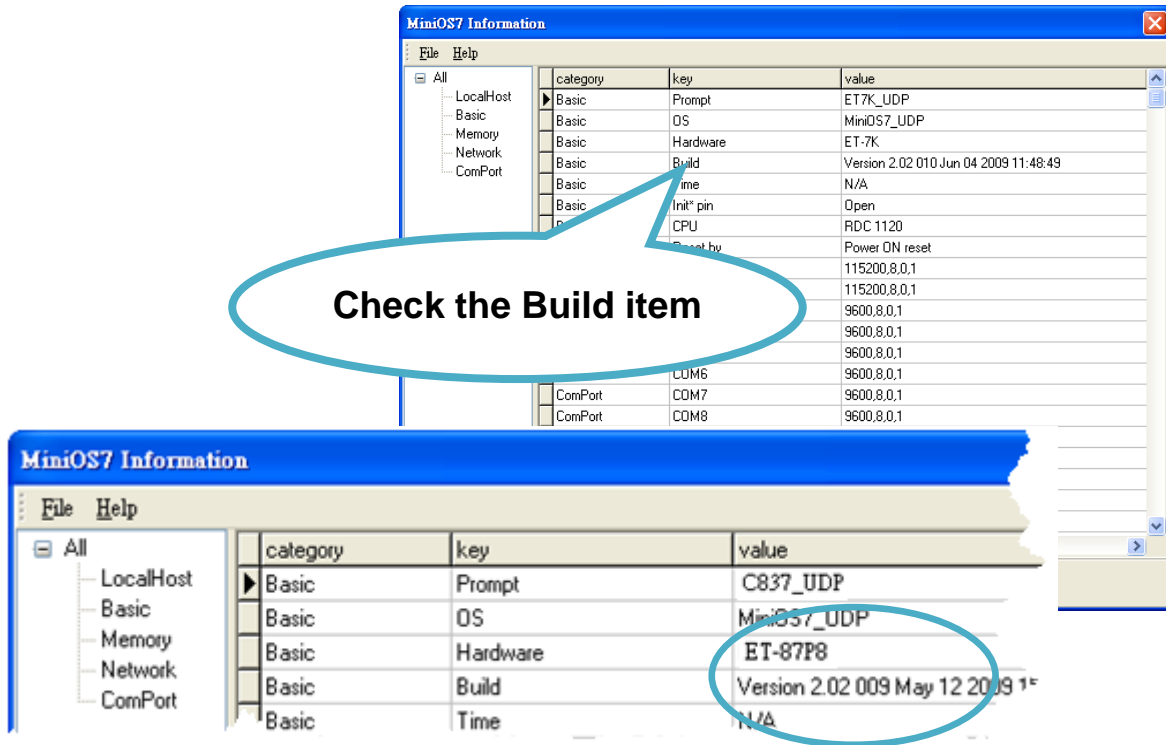

5.2. Firmware Updates

The firmware is stored in flash memory and can be updated to fix functionality issues or add additional features, so we advise you to periodically check the ICP DAS web site for the latest updates.

Step 1: Get the latest version of the MiniOS7 firmware and the autoexec.bat file

The latest version of the MiniOS7 firmware and autoexec.bat file can be obtained from:

CD:\NAPDOS\87pn_io_unit\ET-87Pn\Firmware\

ftp://ftp.icpdas.com/pub/cd/8000cd/napdos/87pn_io_unit/et-87pn/firmware/

Step 2: Run the MiniOS7 Utility



Double-click the MiniOS7 Utility shortcut on your desktop.

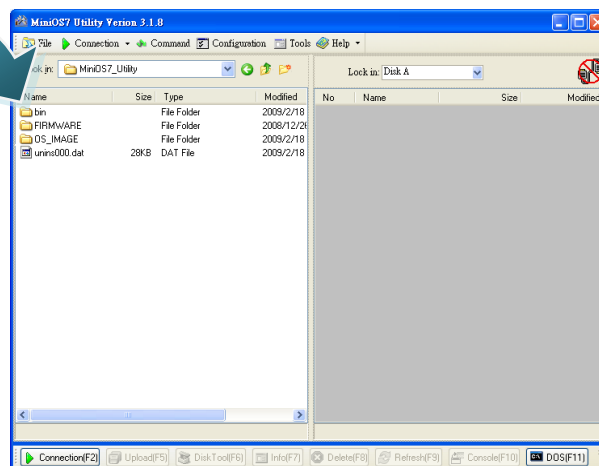

Step 3: Choose "Search" from the "Connection" menu

After choosing Search from Connection menu, that will search all of the MiniOS7 modules on your network.

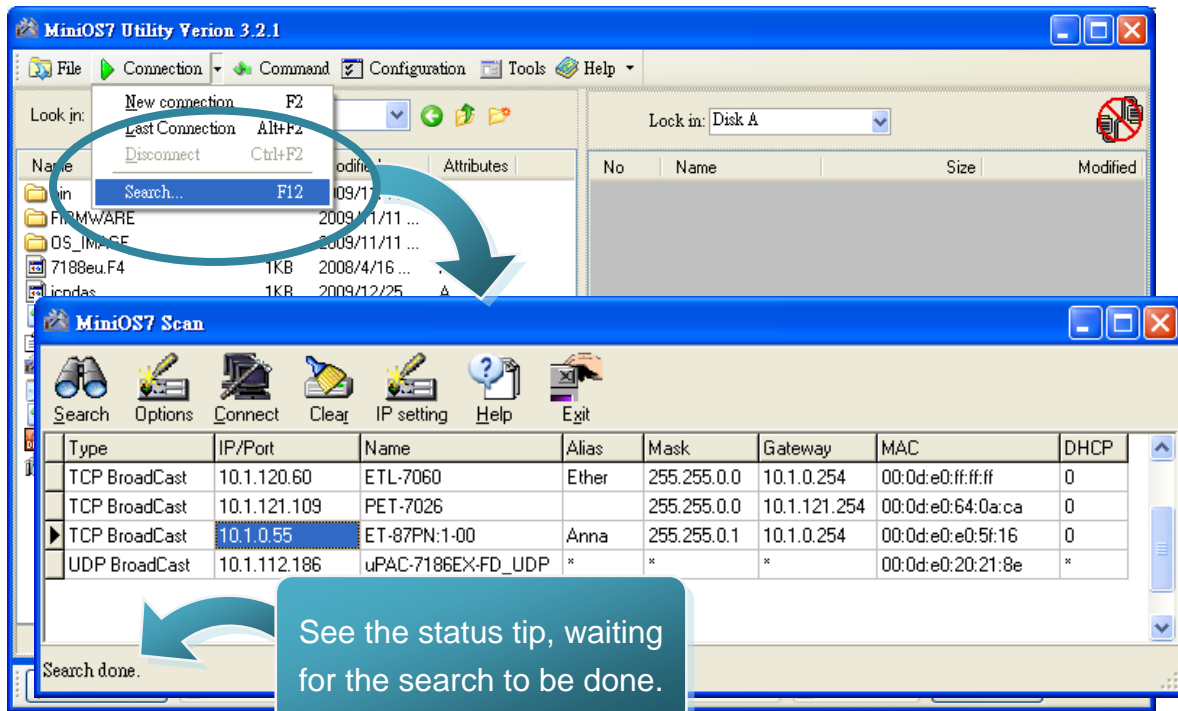

Step 4: Double-Click the field of your ET-87P2/4/8 module

Double-Click the field of your ET-87P2/4/8 module in the list to connect to your ET-87P2/4/8.

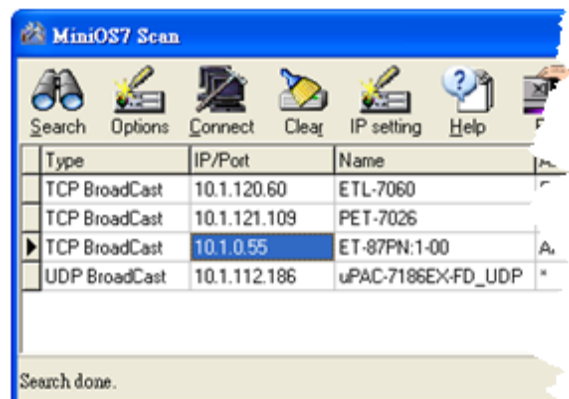

Step 5: The connection has ready been established

Check the connection status in the top right side to make sure the connection has been established

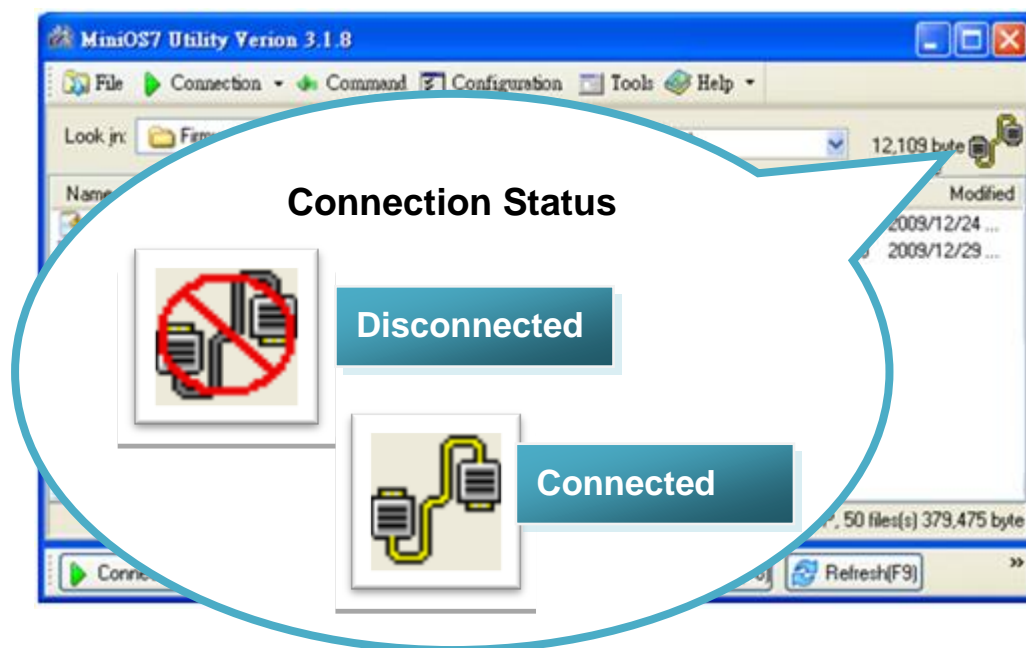

Step 6: Choose “Erase Disk” from the “Command” menu

After establishing a connection, then choose Erase Disk from Command menu to erase the contents of the flash memory.

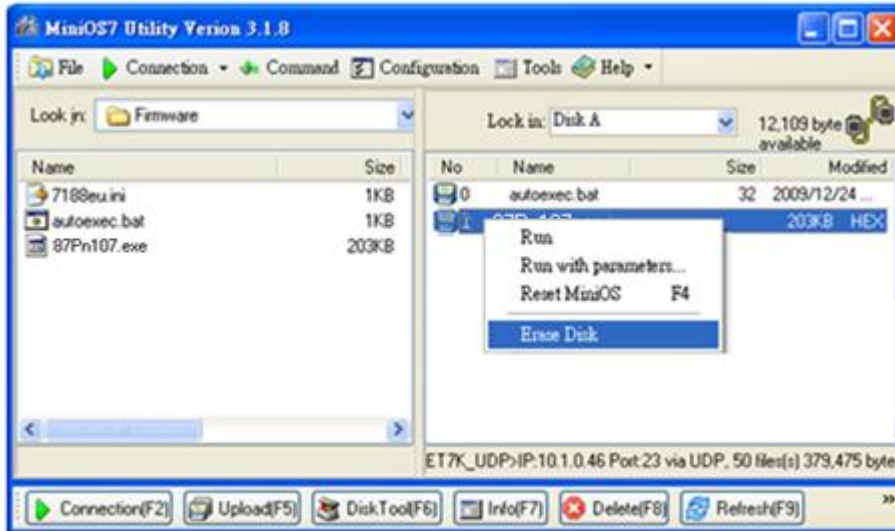

Tips & Warnings



You have to delete all files existed on the ET-87P2/4/8 before uploading the firmware.

Step 7: Click “Yes” to continue

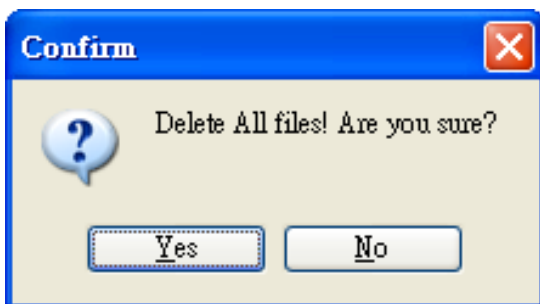

After executing the Erase Disk command, the Confirm dialog will appear, and then click Yes button to continue erasing the memory contents.

Step 8: Select the latest version of the MiniOS7 firmware and autoexec.bat file

After confirming the command, all files of the ET-87P2/4/8 will be deleted. Select MiniOS7 Image file will appear, and then select the latest version of the MiniOS7 OS image.

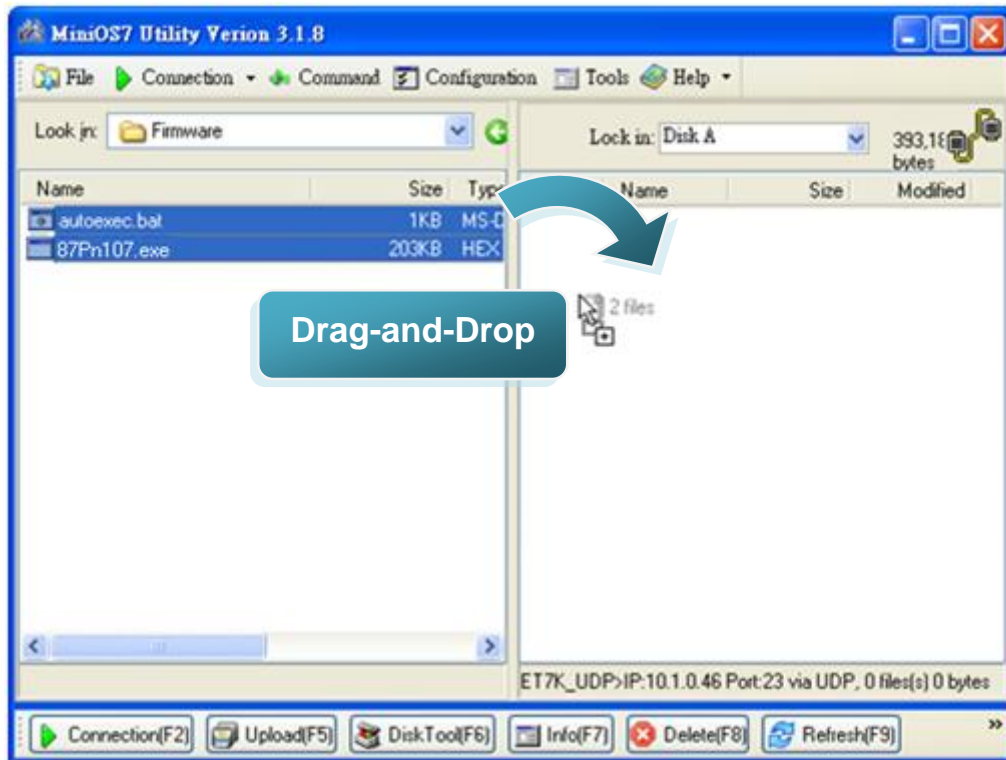

Step 9: Click OK to finish and restart the MiniOS7 Utility

After confirming the command, you just need to wait awhile until the following dialog appear, and then click OK button to finish the procedure.

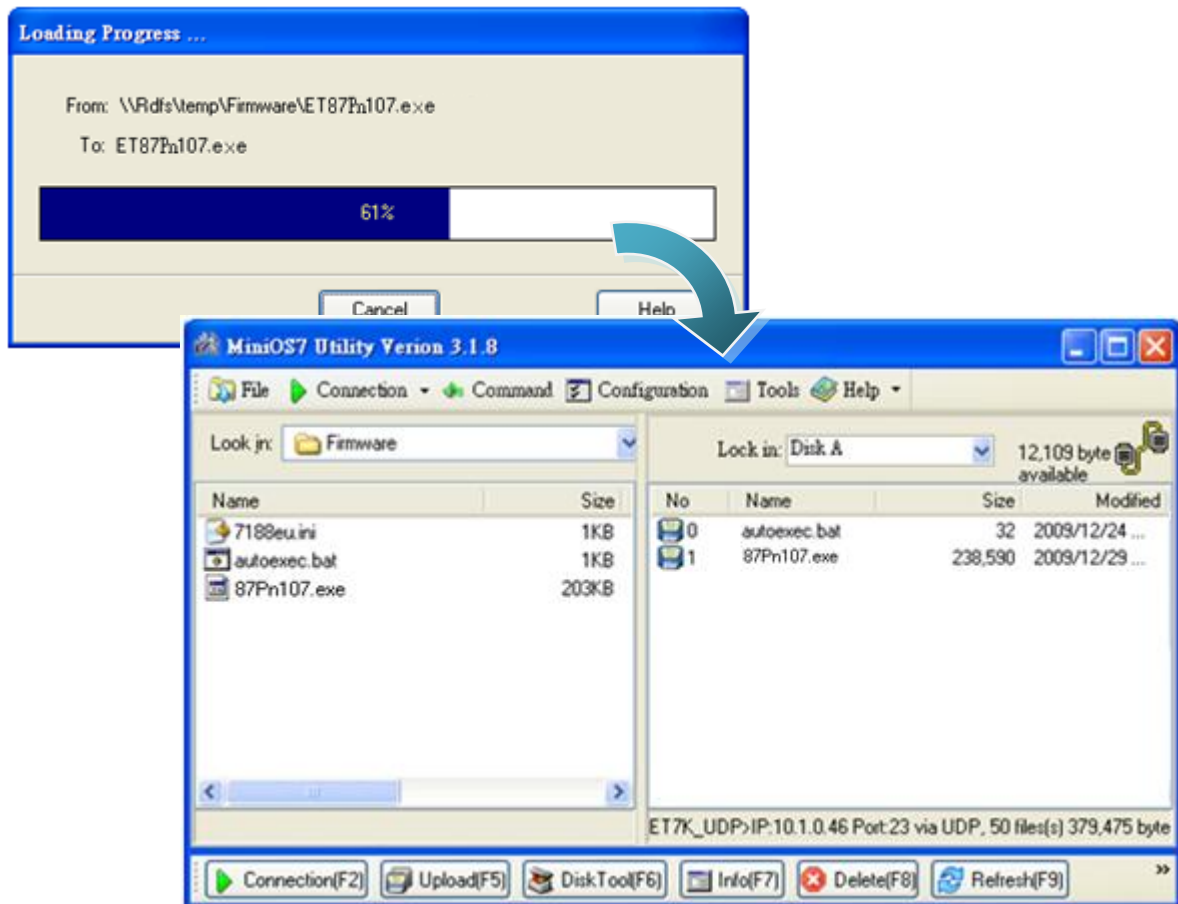

Appendix A. Frame Ground

Electronic circuits are constantly vulnerable to Electro-Static Discharge (ESD), which become worse in a continental climate area. Some I-7000 ,M-7000 and I-8000 series modules feature a new design for the frame ground, which provides a path for bypassing ESD, allowing enhanced static protection (ESD) capability and ensures that the module is more reliable.

The following options will provide a better protection for the module:

The ET-87P2/4/8 has a metallic board attached to the back of the plastic basket as shown in the Figure 2-1 below. When mounted to the DIN rail, connect the DIN rail to the earth ground because the DIN rail is in contact with the upper frame ground as shown in the Figure 2-2 below.

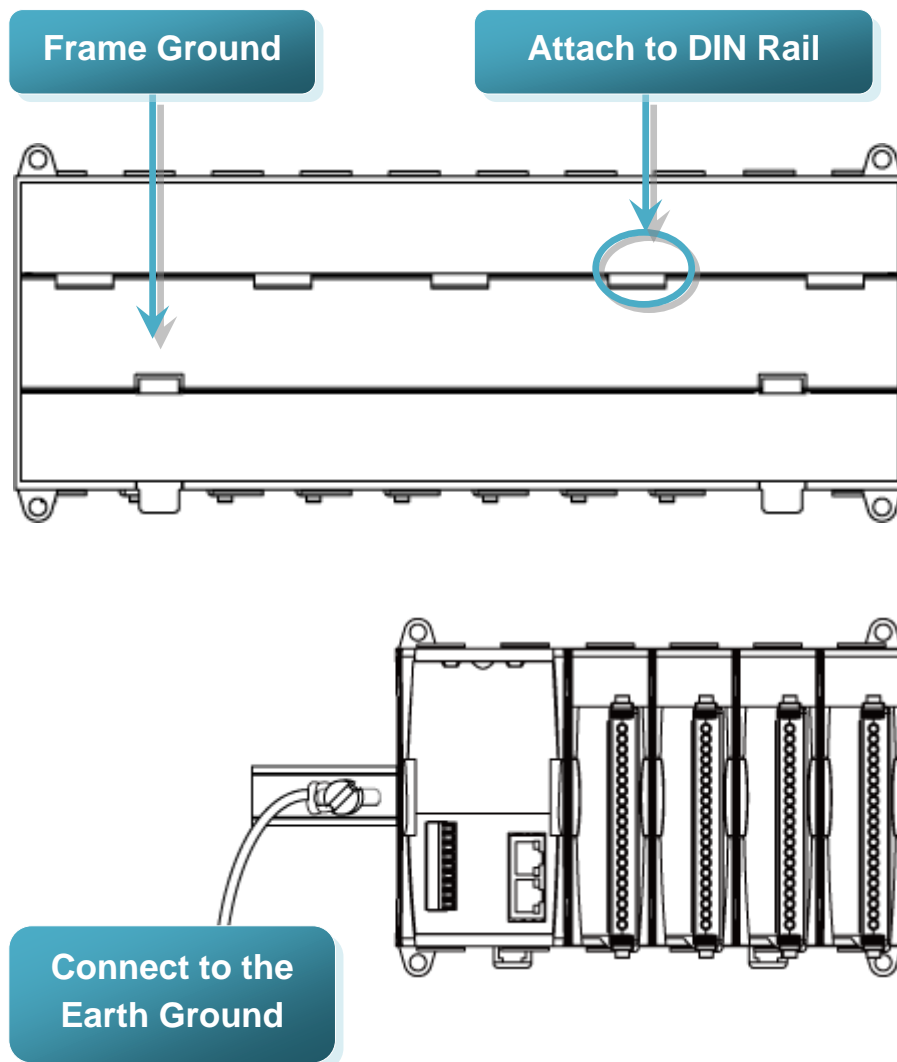

Appendix B. I/O Configuration Files

While you save the I/O configuration file, the DCON Utility will save as .ini file. The default path of file as below:

C:\ICPDAS\DCON_Utility\for_users

The INI file explains as follows:

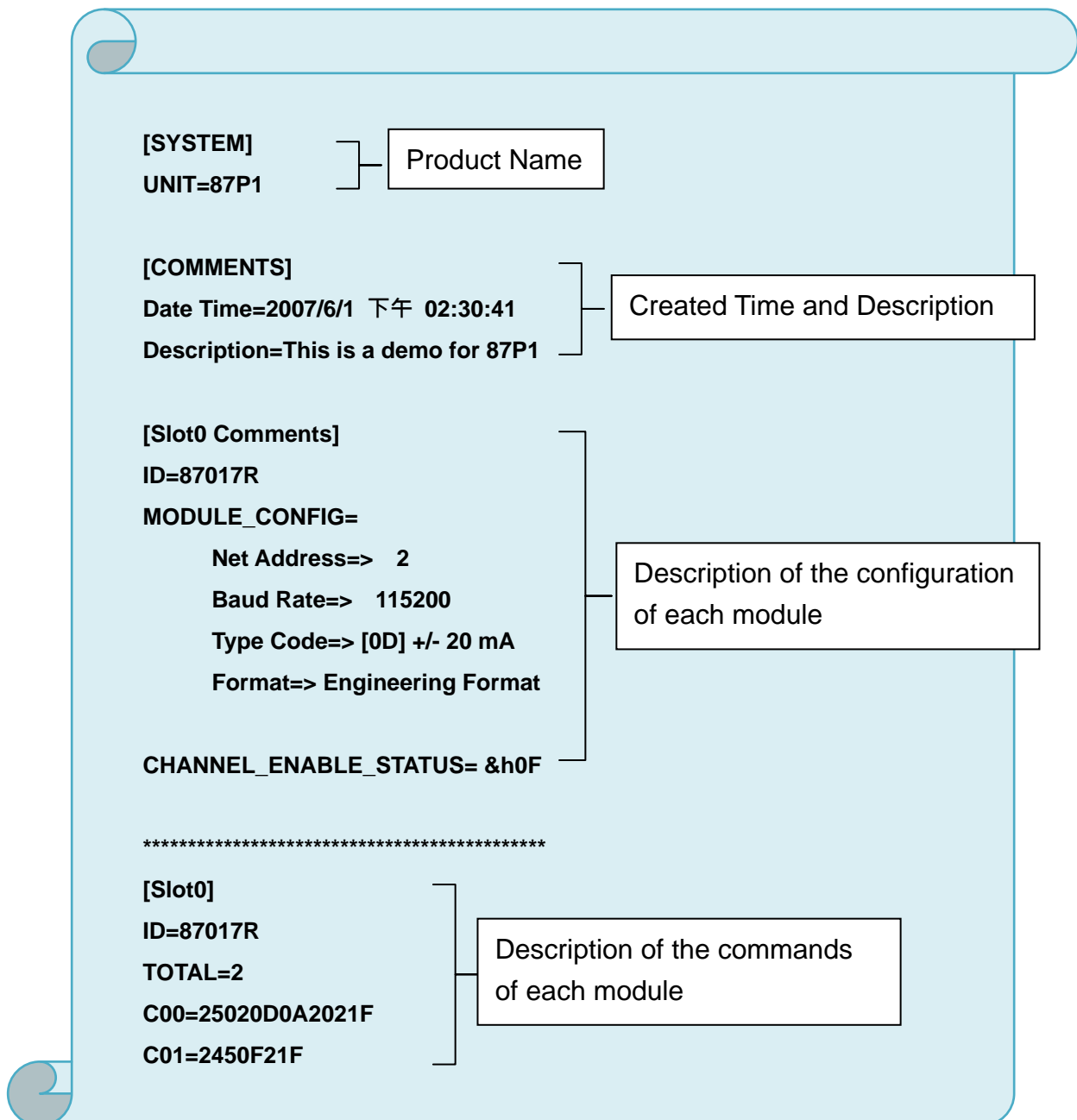

Appendix C. Troubleshooting

This appendix lists some troubleshooting guidelines for working with ET-87P2/4/8.

Error Code	Slot LED (Red)	Status	Description	Solution
00H	Dark (ok)	OK	OK	None
01H	Flashing (Warning)	Module scanned in Empty Slot	1. There is a module scanned in this empty setting slot.	1. Remove the module
			2. The first time to setup, no initial value.	Reconfigure it with DCON Utility. 1. Click "Set As Scanned" button and configure module again 2. Click "Write To 87Pn" button to write settings to 87Pn.
02H	Flashing (Warning)	Commands not comparable	Configure failure:	1. Check the i-87K I/O module's firmware.
			This is a 87K I/O module firmware compatibility problem Some commands at this slot might be too new for this old firmware of 87K I/O module, but it is not serious for system operation.	* Run Dcon Utility→Terminal→Dcon command Line→ setup Baud Rate→Command: \$AAF (EX. 01F) →Send * You can see the version, Respond=!01A1.9 2. Update the 87K I/O module with a new firmware version.
03H	Bright (Error)	Configuration Failed	Configure failure:	1. Check the 87K I/O module firmware
			Some commands are not supported by this 87K I/O module and this error will be serious for system	2. Update the 87K I/O module with a new firmware version.

Error Code	Slot LED (Red)	Status	Description	Solution
			operation.	
04H	Bright (Error)	wrong Configuration format	Configure failure:	1. Run DCON Utility. 2. Click the "Write To 87Pn" button to write the settings to 87Pn CPU again.
			The format of configured commands is wrong for DCON Protocol.	
05H	Bright (Error)	Read Configuration failed	The memory data is failed :	1. Run DCON Utility. 2. Click the "Write To 87Pn" button to write the settings to 87Pn CPU again.
			The configured commands are wrong for DCON Protocol.	
06H	Bright (Error)	Cannot find module	The configured module at this slot has been removed. It is empty now.	1. Please insert a correct module as previous configured one. 2. Or configure with DCON Utility as "Empty" and click the "Write To 87Pn" button to write the configuration to 87Pn CPU.
07H	Bright (Error)	Incorrect module name	Configure failure:	The insert & configure module name are different, insert the correct one or run the Dcon Utility to modify the settings accord with the module name.
			The module inserted in this slot is not the same as previous configured.	
08H	Bright (Error)	Internal INIT* pin failed	Configure failure:	1. Please restart the power to initialize to I/O module 2. If it still failed to initialize, send it back to factory to check. Note: RU-87Pn only supports high profile 87K I/O modules.
			The INIT Pin is failed to connect with the GND and module failed to initialize.	

Error Code	Slot LED (Red)	Status	Description	Solution
09H	Bright (Error)	Module address over 255 (FFh)	The module address is over 255 (FFh).	The maximum address of 87P1 is 254 (FEh) 87P2 is 253 (FDh) 87P4 is 251 (FBh) 87P8 is 247 (F7h)
0AH	Bright (Error)	The command count saved to 87Pn is not the same as DCON Utility	This error might be caused by following reasons. 1. Command length error. 2. Command checksum error. 3. Communication error during the process of writing commands to 87Pn.	Please configure this 87K I/O module with DCON Utility, and click the "Write To 87Pn" button to write the configuration to 87Pn CPU again.
0BH	Bright (Error)	Module response failed	This error might be caused by following reasons. Module response failed above 5 times.	Please restart the power to initialize to I/O module, or configure this 87K I/O module with DCON Utility, and click the "Write To 87Pn" (This function only support in 87Pn firmware A107 or above)
0CH	Bright (Error)	Module name invalid	This error might be caused by following reasons. Module is not 87K high profile I/O modules.	87Pn only supports 87K high profile I/O modules. Please replace it as 87K I/O module, you could refer http://www.icpdas.com/products/PAC/i-8000/8000_IO_modules.htm (This function only support in 87Pn firmware A107 or above)

Appendix D. Technical Support

ICP DAS is committed to providing you with excellent service and support.

If you experience any problems with your ET-87P2/4/8 system, and are unable to find the solution you need within our manual, please contact ICP DAS Technical Support.

Email: service@icpdas.com

Website: <http://www.icpdas.com/service/support.htm>

When contacting Technical Support, please be prepared to provide the following information:

Contact Details

1. User's name, company name
2. E-mail address

System Details

1. Product name
2. Serial Number (The serial number is printed on the barcode label attached to the cover of the module.)
3. Windows operating system version
4. Firmware version, OS version
5. A list of external devices connected to the computer.
6. Brief description of the problem or error, and the specific text of any error messages.

ICP DAS will reply to your request by email within three business days.