

GT-534

Intelligent SMS alarm controller

User Manual v1.03



High Quality, Industrial Data Acquisition, and Control Products

Warranty

All products manufactured by ICP DAS are warranted against defective materials for a period of one year from the date of delivery to the original purchaser.

Warning

ICP DAS assumes no liability for damages consequent to the use of this product. ICP DAS reserves the right to change this manual at any time without notice. The information furnished by ICP DAS is believed to be accurate and reliable. However, no responsibility is assumed by ICP DAS for its use, or for any infringements of patents or other rights of third parties resulting from its use.

Copyright

Copyright 2010 by ICP DAS CO., LTD. All rights reserved worldwide.

Trademark

The names used for identification only may be registered trademarks of their respective companies.

Version	Date	Author	Description
1.00	2010/06/01	Jiunan	Release version
1.01	2011/05/04	Malo	Fix the content of “device parameter”
1.02	2012/01/16	Malo	Add GT-534P
1.03	2013/08/01	Kane	Modify spce.

Table of Contents

1.	Introduction	1
1.1	Features.....	2
1.2	Applications.....	2
2.	Hardware	5
2.1	Specifications	5
2.2	Appearance and pin assignments.....	7
2.3	Dimensions	8
2.4	DI/DO Internal Structure and Wire Connection	9
2.5	LED indicators.....	10
2.6	Installing GT-534.....	11
2.7	How to reset GT-534	11
2.8	Charge and discharge of Li-Battery.....	12
3.	Installing GT-534 Utility	13
3.1	Installing .NET Compact Framework	13
3.2	Installing GT-534 Utility	15
4.	GT-534 Utility operation.....	18
4.1	Main menu.....	19
4.2	Operation Language	21
4.3	Login.....	22
4.4	Device parameter.....	25
4.5	SMS Recorder	33
4.6	Device Time.....	35
4.7	Counter Value	36
4.8	Change Password.....	37
4.9	DO control/DI/AI status	38
4.10	SD/Battery information	39
4.11	Signal Quality & GPS data.....	40
4.12	Version.....	41
4.13	System	42
5.	SMS Command	43
5.1	@TIME (Time set and inquiry).....	44
5.2	@DOCn (DO control)	45
5.3	@ACTV (Counter value inquiry).....	46
5.4	@DIV (DI/DO inquiry)	47
5.5	@AIV (DI/DO inquiry)	48

5.6	@BAT (Battery inquiry)	48
5.7	@SD(information of SD card)	50
5.8	@PASS(Password inquiry).....	50
6.	Send/Receive SMS and Call out by COM	52
6.1	Send data to COM port of GT-534 by SMS command	52
6.2	Sending SMS by COM(RS-232/RS-485).....	52
6.3	Sending Sound by COM (RS-232/RS-485)	52
7.	Data Records and Audio file format.....	54
7.1	Data Records Format	54
7.2	Audio File Format	54
8.	DO output by DTMF	55
9.	Troubleshooting.....	56

1. Introduction

The GT-534 is an intelligent SMS/GSM module, with high cost-effective cost, for industry applications with the simple commands and SMS tunnel function, and power can be input by the external power or Li-Battery. It supports UNICODE or 7 bit format for users to implement sending SMS messages with various languages. The GT-534 also provides the sound alarm application with the pre-defined voice files. In addition, the DTMF function of the GT-534 is for the applications with the keypad of phones to control the local I/O. And, With the SMS DBS software of ICP DAS, users can manage the GT-534 in PC centrally.

The GT-534 can be a remote control and alarm system allowing you to use your mobile phone to monitor and control your business from any location. Its alarm facilities provide a flexible way to distribute critical alarm information to any number of mobile phone users.

The GT-534 can monitor total 6 digital inputs and 1 AI input. A SMS/Sound can be sent when these DI are triggered or counters exceed preset limits. The user can also interrogate the status of I/O through SMS messages. It also provides an analogy input for Four-phase alarm. The GT-534 also has 2 Digital output which can be activated via DI trigger or SMS to control the lamps, pumps, heaters etc.

Other than those functions described above, the simple I/O linkage function of the GT-540 series can reach the real time control in the local field. It also has I/O data logger function which save I/O data in SD card.



1.1 Features

- Support 850/900/1800/1900 MHz tri-band frequency
- Support SMS DBS software (http://m2m.icpdas.com/SMS_DBS.html)
- Identify ASCII or Unicode SMS Automatically
- Support max. 140 ASCII Characters
- Support max. 70 Unicode Characters
- Built-in ASCII Commands and SMS tunnel Communication Modes
- Max. 10 Default Phone Numbers
- Built-in Watch-dog Function
- Support SMS setting and control
- 6 DI, 2 DO, 1 AI, 2 RS232 port
- DO control by dual-tone multi-frequency
- Digital input support NC(normal close)/NO(normal open)/Counter modes
- Periodic SMS report
- Voice Alarm and SMS triggered by DI trigger or exceed **AI/Counter** preset limits
- Support simple command to send SMS via RS232
- Support micro SD card. (Max 2G bytes)
- Support data log
- Support DC +10 VDC ~ +30 VDC Power Input
- Supports 3.7 V Li-ion Battery Backup
- DIN Rail design
- Support Open GeoSMS protocol (GT-534P)

1.2 Applications

- Remote equipment maintenance and automation
- Vending or Gaming monitor system
- Home/Factory security
- Escalators & Elevators
- Energy Management
- Temperature Monitoring

Application 1: Signal Alarm and SMS communication

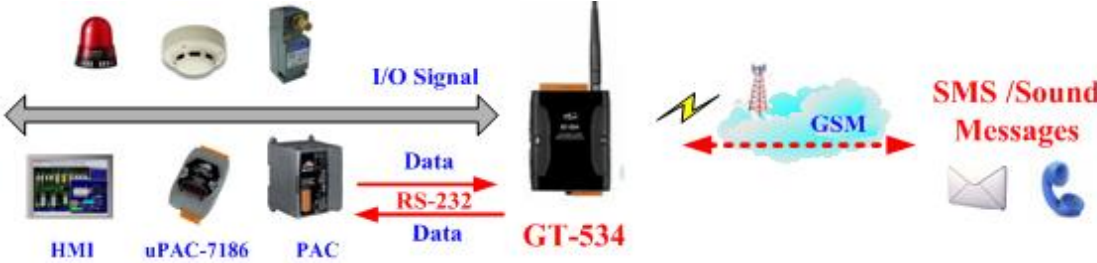

Application 2: Home security



Application 3: Remote maintenance



Application 4: SMS Tunnel Communication



2. Hardware

2.1 Specifications

	GT-534	GT-534P
System		
CPU	32 bit CPU, 96M Hz	
SRAM	32K Bytes	
Flash Memory	512K Bytes	
RTC	Gives time(sec, min, hour) & date, leap year compensation from 1980 to 2079	
WDT(watchdog)	Yes	
Serial ports		
COM1	RS-232 : Tx,D,RxD,GND (for configuration)	
COM2	RS-485 : DATA+,DATA-	
DIO		
Input	6 Channel (Counter 5~40Hz) On Voltage : +3.5~24VDC Off Voltage : +1V Max.	
Output	DO :2 Channel(isolation) ON Voltage:+24.0 V OFF Voltage: +1.0 V MAX	
GPRS/GSM Module		
GPRS/GSM	GPRS/GSM Tri-Band 850/900/1800/1900 MHz GPRS multi-slot : class 10/8 GPRS mobile station : class B Compliant to GSM phase 2/2+ -Class 4(2W @ 900 MHz) -Class 1(1W @ 1800/1900 MHz) Coding schemes : CS 1, CS 2,CS 3,CS 4 SMS: Text and PDU mode	
Analogy Input		
Input Channel	1	
Input Type	0 ~ 20 mA	
Resolution	12 bits	
Sampling Rate	1 samples/ second	
Save interface		
interface	MicroSD, Maximum 2G	

Sound format	
File type	*.wav
File format	PCM
Sound data bit	16 bits
Sound channel	Single track
Sound SamplesPerSec	8 kHz, 11 kHz
GPS	
Support Protocol	- Open GeoSMS format
Power	
Protection	Reverse polarity protection
Frame Ground Protection	ESD, Surge, EFT, Hi-Pot
Required Supply Voltage	+10 VDC ~ +30 VDC with 600 mAh Li-ion battery backup (Option : 1200 mAh)
Mechanical	
Casing	Plastic
Flammability	UL 94V-0 materials
Dimensions (W x H x D)	91 mm x 132 mm x 52 mm
Installation	DIN-Rail
Environment	
Operating Temperature	-25 °C ~ +55 °C
Storage Temperature	-40 °C ~ +80 °C
Humidity	5 ~ 95% RH, non-condensing

2.2 Appearance and pin assignments

Pin assignments :

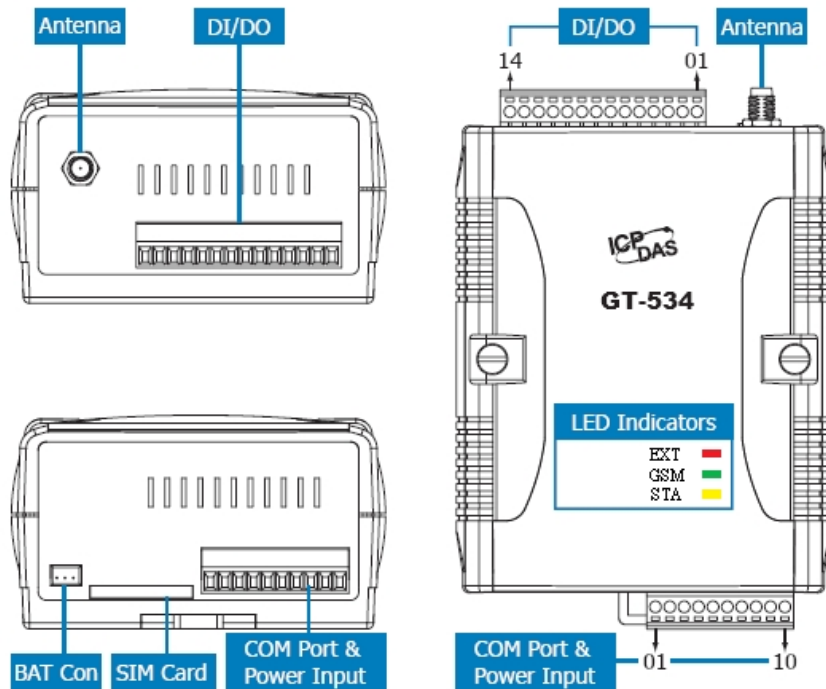

DI/DO		
Terminal No.		Pin Assignment
DI	01	DI0
	02	DI1
	03	DI2
	04	DI3
	05	DI4
	06	DI5
DI COM	07	DI COM
DO PWR	08	DO PWR
DO	09	DO0
	10	DO1
DO GND	11	DO GND
-	12	-
Ain+	13	Ain+
Ain-	14	Ain-

COM Port & Power Input			
Terminal No.		Pin Assignment	
Ground for COM		01	GND
COM1 RS-232		02	RxD1
		03	TxD1
COM2 RS-485		04	D+
		05	D-
Reset		06	RST+
		07	RST-
Power Input: +10 ~ 30V _{DC}		08	DC.+VS
		09	DC.GND
Frame Ground		10	F.G

2.3 Dimensions

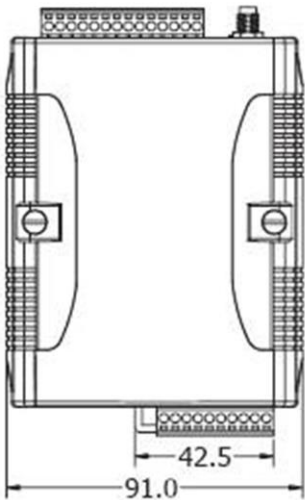

Front View

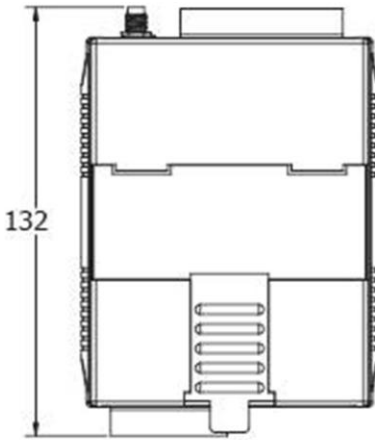

Back View

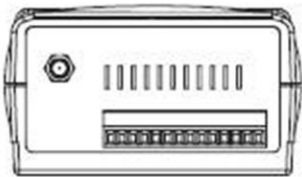

Top View

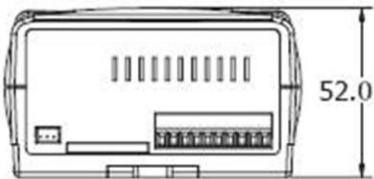

Bottom View

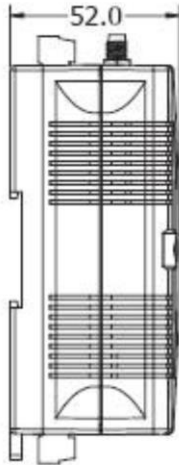

Left Side View

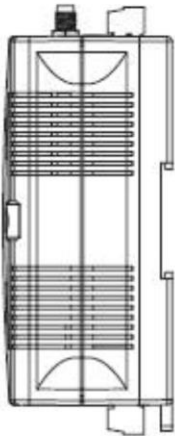

Right Side View

2.4 DI/DO Internal Structure and Wire Connection

2.4.1 DI Internal Structure

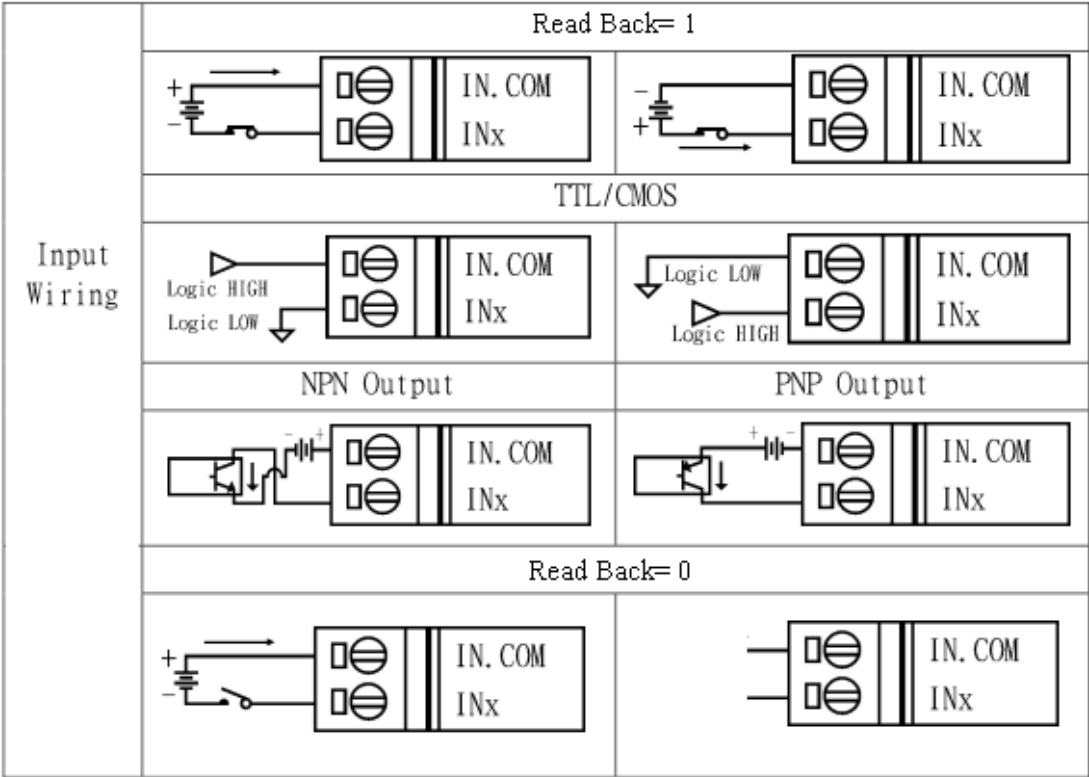

2.4.2 DO wire connection

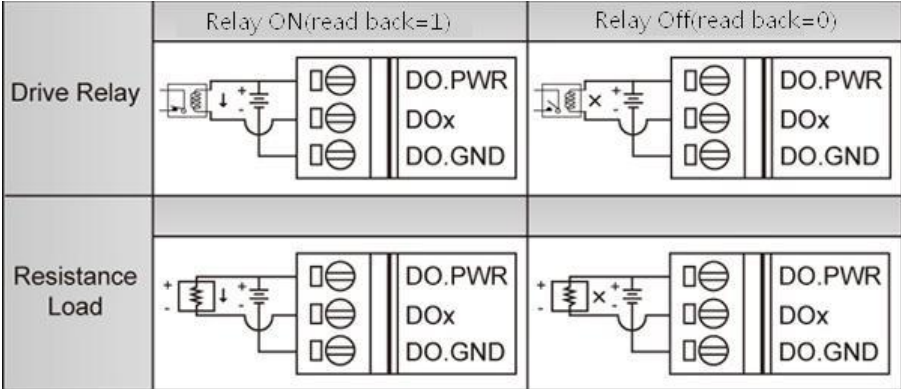

2.5 LED indicators

There are three LED indicators to help users to judge the various conditions of GT-534. The description is as follows :

- A. EXT(Red) : External Power LED to indicate whether the external power is input or not.

The external power is active	The external power is not active
on	off

- B. STA(Orange) : System LED is to indicate if the GT-534 is normal or fail.

Condition External power	Normal	GSM Fail	PIN code is wrong
On	Blanking (1 sec)	Always on or off	Blinking per 50 ms
Off	Blanking (1 sec)	Always on	Blanking per 50 ms

- C. GSM (Green) : The modem LED can indicate the status of GSM module.

Modem normal	Modem fail
Blanking (3 sec)	Off or Blanking (not 3 sec)

- D. GPS(Green) : The GPS LED can indicate the status of GPS module.

Search GPS	Receive GPS data
Always ON	Blanking (1 sec)

2.6 Installing GT-534

If users want to start GT-534 normally, it needs to follow these steps to install the GT-534 below:

- A. Install the GSM antenna
- B. Plug in the normal SIM card (Before apply the SIM card, confirm it is OK by mobile phone.)
- C. Pin08 and Pin09 connect to the DC.+VS and DC.GND of the power supply.
- D. Follow the section 2.4 to wire the I/O connection.
- E. If you want to use the backup power, please connect the Li-battery to GT-534.
- F. It is needed to wait for 30 ~ 50 seconds to search the GSM base and register to the ISP. After finishing the process, GT-534 would be in the normal operation mode and the STA LED would blank per 3 sec. The start time of GT-534 depends on the strength of signal.



2.7 How to reset GT-534

2.7.1 The Li-Battery is applied :

- (1) Remove Li-Battery from GT-534.
- (2) Turn off the external power and confirm the EXT LED is off.
- (3) Turn on the external power.
- (4) Re-install the Li-Battery.

2.7.2 The Li-Battery is not applied

- (1) Turn off the external power and confirm the EXT LED is off.
- (2) Turn on the power.

2.8 Charge and discharge of Li-Battery

If users apply the Li-Battery on GT-534, the Li-battery would be charged by the external power automatically. When the external power is removed from GT-534, the power supplying to GT-534 is from Li-Battery. If the voltage of Li-Battery is lower than the preset limit, GT-534 can send the SMS message to inform the users.

Note: A new Li-Battery can supply power to GT-534 for 6 hours without the external power. The power volume of Li-Battery would be decreasing for a long time. It is recommended to change the Li-Battery every 6 months.

3. Installing GT-534 Utility

It needs the runtime environment with .NET Framework 2.0 or above to execute the GT-534 Utility in the PC. If there has .NET Framework 2.0 or above in the PC, the section 3.1 can be omitted.

3.1 Installing .NET Compact Framework

- A. Download .NET Framework 2.0 from MS
<http://download.microsoft.com/download/5/6/7/567758a3-759e-473e-bf8f-52154438565a/dotnetfx.exe>
- B. Execute dotnetfx.exe
- C. The install figure is as follows:
 - (1) Press “Next” to the next step.

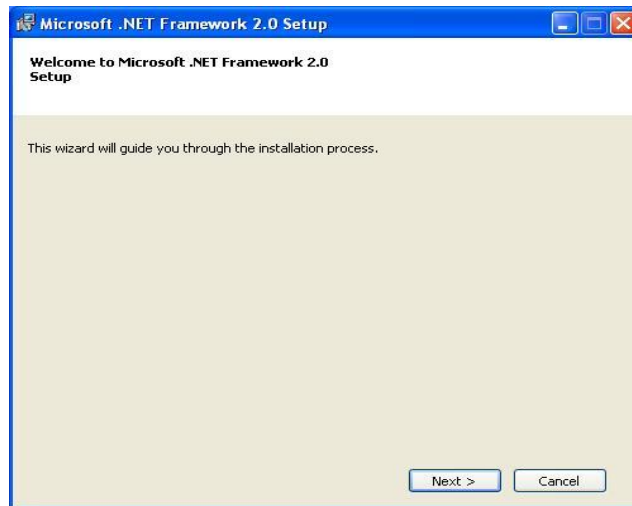

- (2) Select the “I accept the terms of the License Agreement” and “Install ” to the next step.

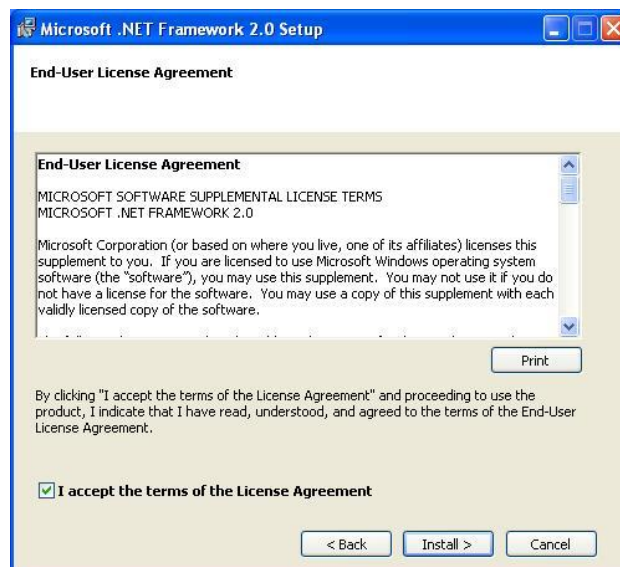

- (3) The installation process would be going

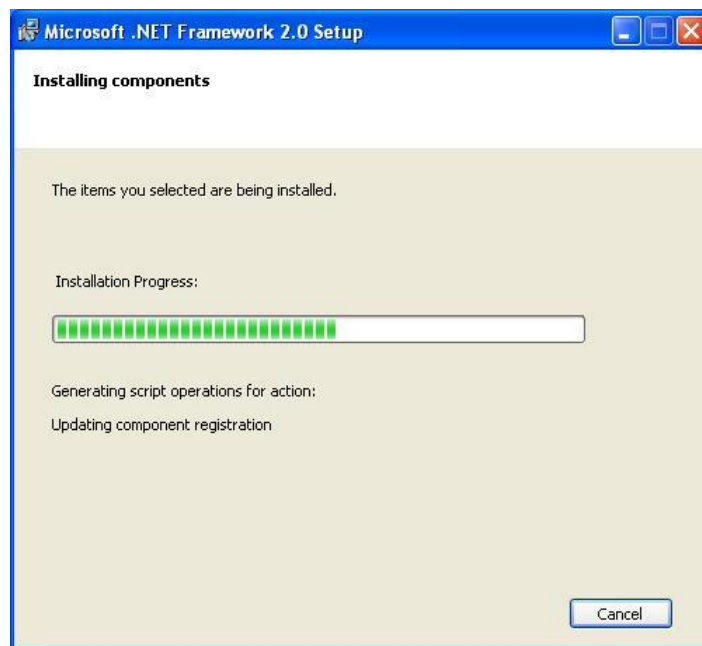

- (4) After finishing the installation, press "Finish" to exit the program.

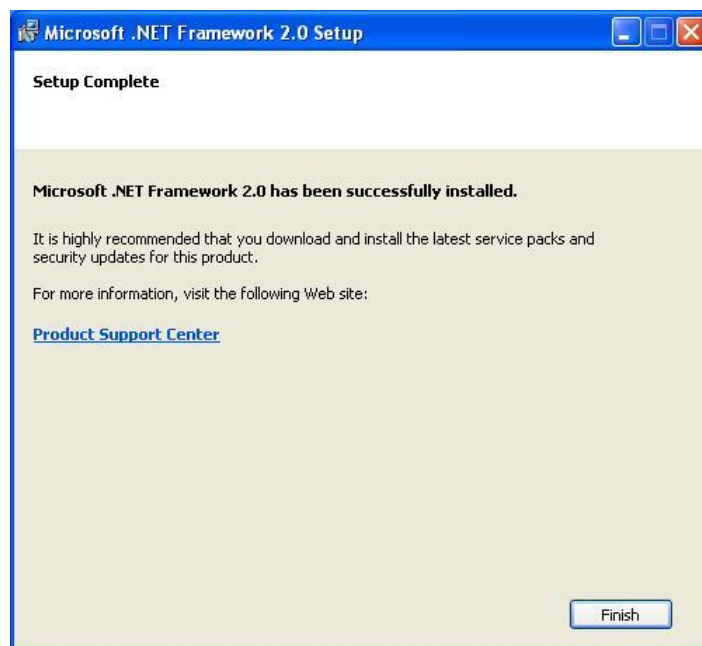

3.2 Installing GT-534 Utility

- A. Plug in the shipment CD into the PC
- B. Execute \GT-534\Utility\SMSUtilitySetup.exe
- C. The installation figure is as follows:
 - (1) Press “Next” to start the installation procedure.

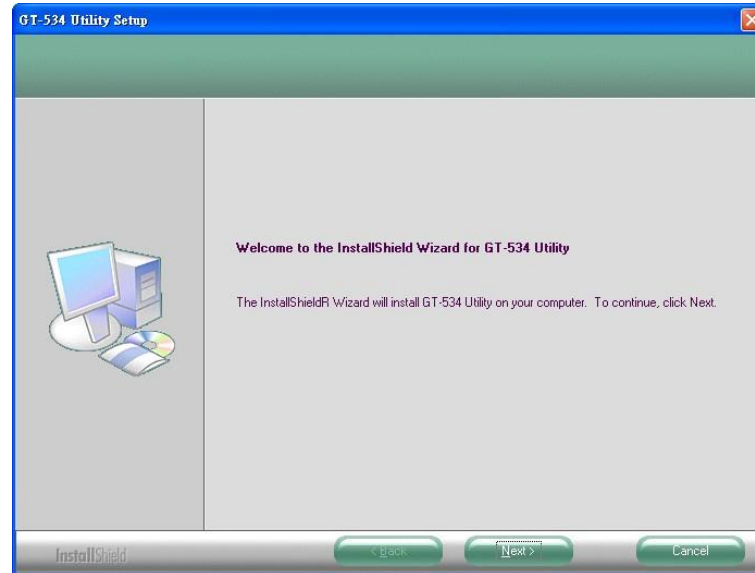

- (2) Select the installation path. The default path is "C:\Program Files\GT-534 Utility". Press “Next” to the next step.

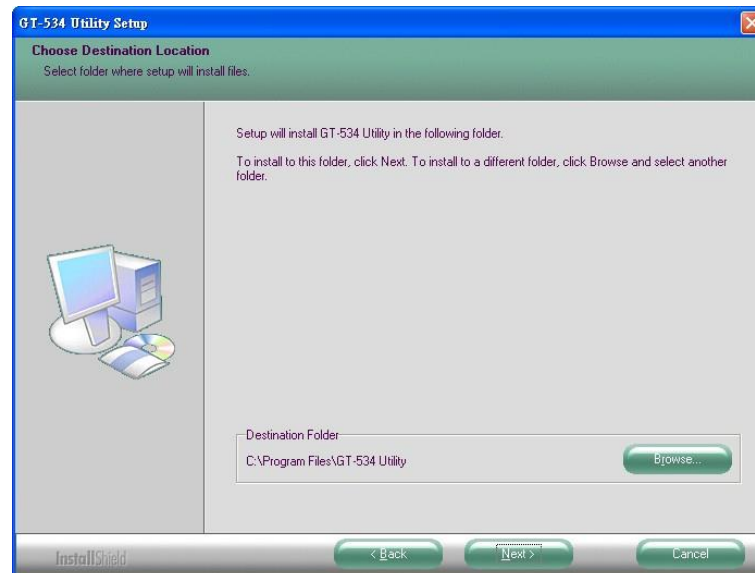

- (3) Input the name shown in “All Programs”. Press “Next” to the next step.

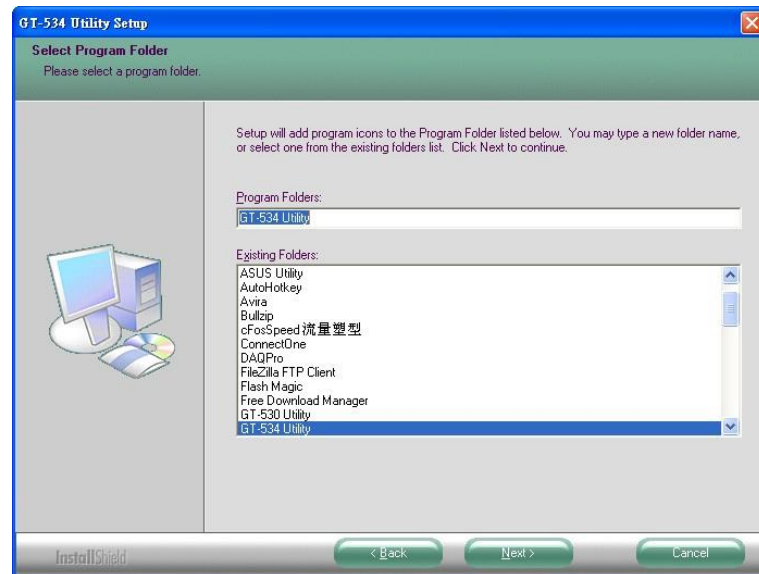

- (4) After finishing the installation procedure, press “OK” to the next step.



- (5) Press "Finish" to finish the installation procedure.

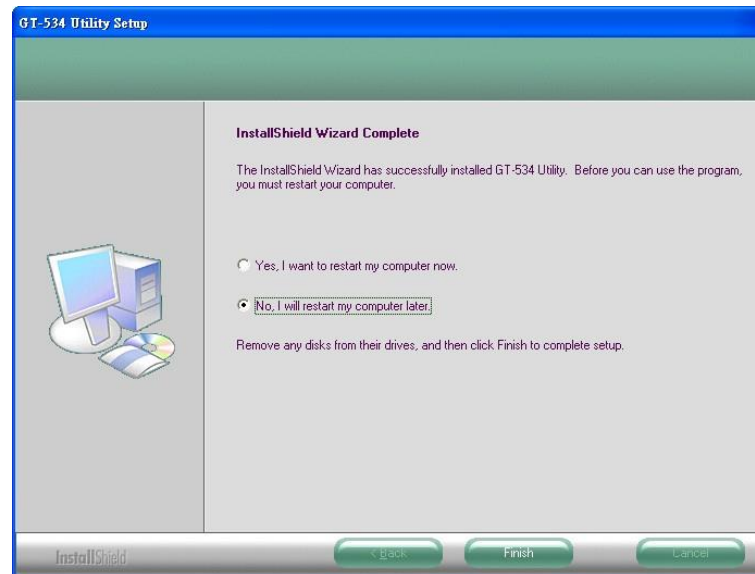

- (6) Launch GT-534 Utility from the start menu "Start→All Programs→GT-534 Utility→GT-534 Utility".



4. GT-534 Utility operation

Before GT-534 utility is connected to the PC correctly, please confirm these following steps:

1. The STA LED is blanking. There are 2 kinds of blanking in GT-534.

STA LED	Description
Blanking per 1 sec	Normal mode
Blanking per 50 ms	The pin code is wrong. The login windows would show the field to input pin or PUK code

2. Confirm the RS232 connection between GT-534 and PC is correct. Users can refer to the following figure.
3. During the setting procedure, the external power must be turn on.

Note: If the STA LED is always on, please reset the GT-534. Refer to section 2.7 for the detail.

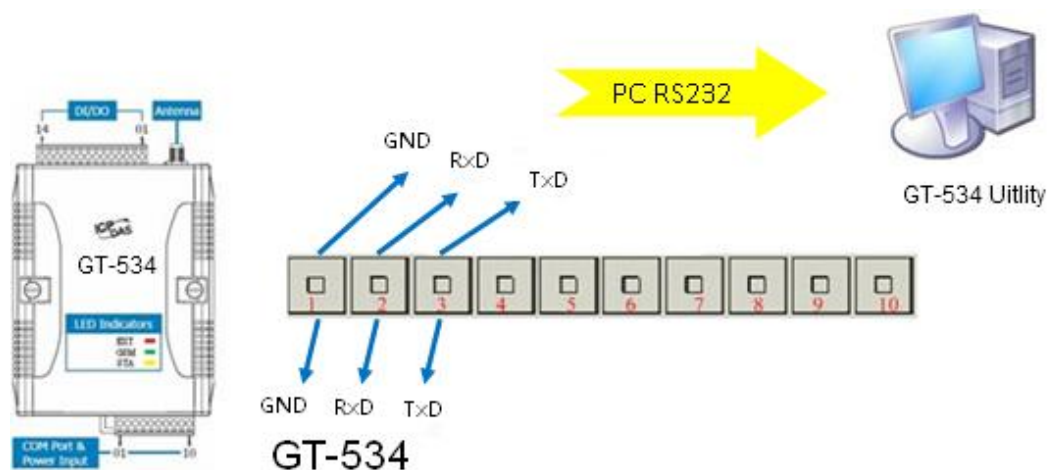

4.1 Main menu

The main menu of GT-534 Utility includes the following sections:

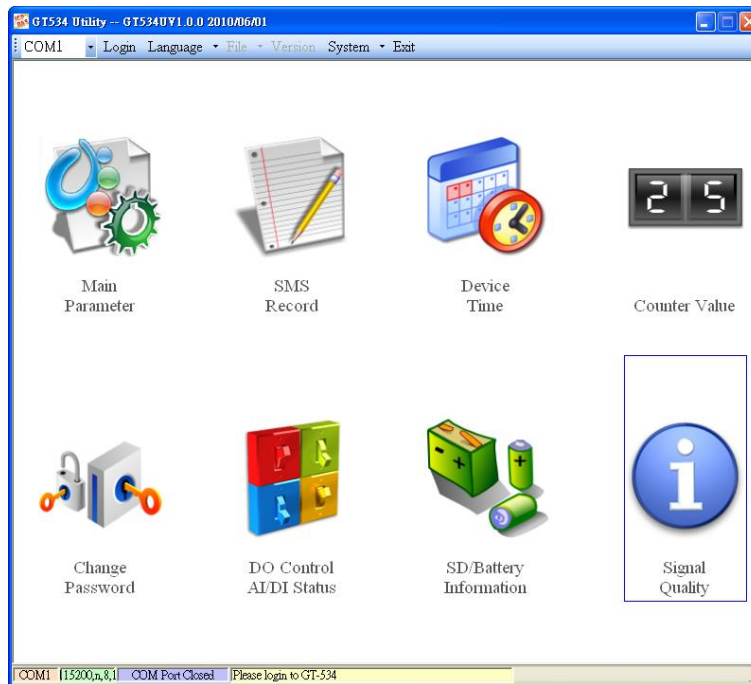

A. Tool menu

- (1) “COM”: Set the COM port number in PC connecting to GT-534.
- (2) Login/Logout

Before operating GT-534, users need to login to GT-534 Utility. After login the system successfully, the menu item “login” would become “logout” and the GT-534 Utility would be operated normally. Once the power is reset, the login procedure needs to do again.

- (3) “Language”

GT-534 Utility supports English, Tradition and Simplified Chinese interface. Users can select which language interface they want from the “Language” item. The language setting would be influencing on the encode of SMS.

- (4) File

There are import and export functions in “File” item. The functions would be enabled when “Main parameters” window is open.

Export: The function can export the parameters as .par file from the “Main parameters” windows.

Import : The parameters would be shown in “Main parameters” window from the specific .par file.

- (5) Version: Including the firmware and Utility version information.
- (6) System: Provide users for recovering GT-534 to factory and resetting

GT-534.

- (7) Exit: To exit GT-534 utility

B. 8 function item :

- (1) “Main parameter”: The main parameter setting of GT-534 includes ID, SIM number, 10 phone number authority, counter return report, event, DI mode, AI alarm and SMS message.
- (2) “SMS record”: Inquire the report recorder of event and counter. The maximum number of recorder in GT-534 is 64.
- (3) “Device time”: Display and set the RTC time of GT-534. It is also can get the information of the last and next time of the return report.
- (4) “Counter Value”: Inquire and set the counter value.
- (5) “Change Password”: Change the login password
- (6) “DO Control/DI/AI statuses”: Display the status of I/O, control the DO output and AI status.
- (7) “SD/Battery information” :Show total size and free size of SD card, and show the voltage and volume of Li-Battery
- (8) “Signal Quality”: Show GSM signal strength in GT-534

C. Status Line

Show the related information during the operation procedure including:

- (1) The com port number of PC
- (2) The communication setting of COM Port
- (3) The status of COM Port
- (4) The result of Utility operation

4.2 Operation Language

GT-534 Utility supports English, Traditional Chinese and Simplified Chinese from the “language” menu bar. The text display in GT-534 Utility and the encode of SMS are depended on the selected language interface.

The format of SMS accords to the selected language. If the 7 BITS format is set, the maximum characters can be sent in SMS is 140. If UCS2, the maximum number is 70 characters. Therefore, if users want to send the Chinese message, it need to select UCS2 encode. After setting the language, it needs to reset GT-534 to enable the setting.

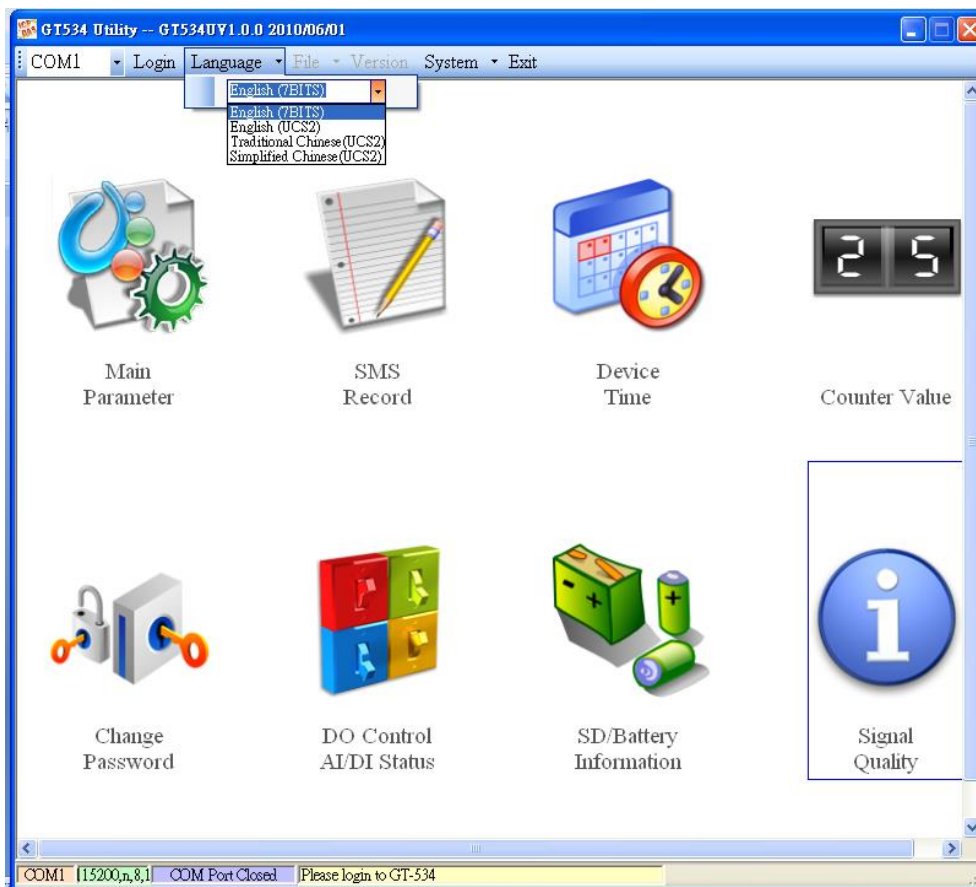

4.3 Login

It needs to login into GT-534 to set its parameters. The description is below:

- (1) Select the COM port number of PC.
- (2) Input the login password. The default is “111111”.
- (3) Press the “login” button
- (4) If you are the first time to login, please set the time of GT-534.

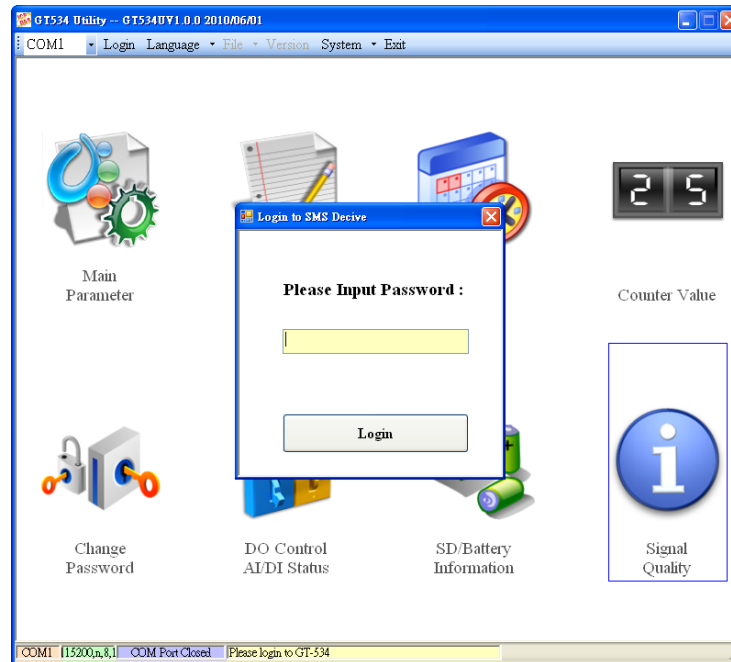

If the pin code in GT-534 is not correct, the STA led would be blanking per 50 ms and GT-534 utility would ask for users to input Pin or PUK code.

- (1) Asking for inputting PIN code:

If the PIN code is effective, the “Enter SIM PIN/SIM PUK” window would pop-up as follows. If the number of times for inputting the wrong PIN code is more than the allowed number, the PIN code would be ineffective. And the “PUK code” window would pop up.

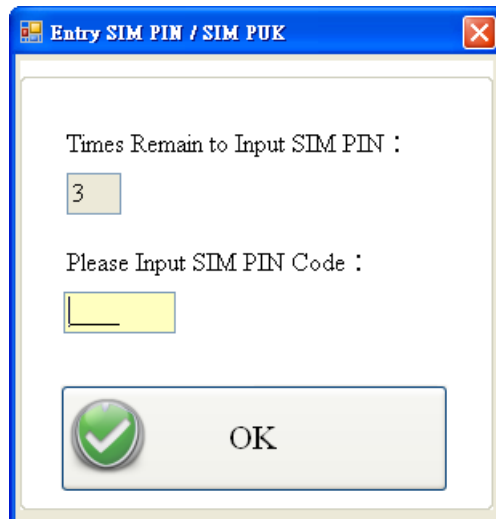

(2) Asking for inputting PUK code

If the PIN code is ineffective, the “PUK code” window would pop-up as follows. As the number of times for inputting the wrong PUK code is more than allowed number, the SIM card would be ineffective forever. Therefore, it is important to input the correct PUK code.

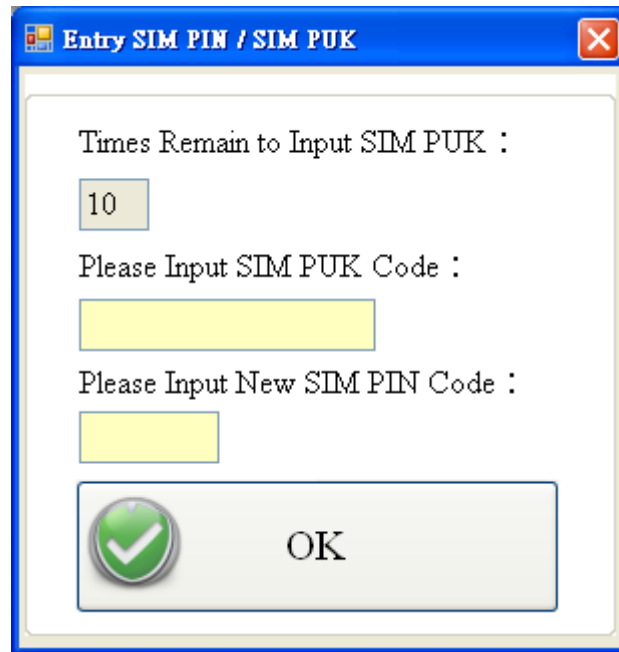

If the PIN or PUK code is correct, the STA led would blank per second. Users can operate other function of GT-534 in this utility.

4.4 Device parameter

There are 2 pages in “Device parameter” window. They are “Phone/Time Report/Alarm” and “DI Type/Text Message” pages.

After configuring the 2 pages, press “Write to Device” button to save these settings to GT-534. Then, reset GT-534 to enable these settings.

The “Read Form Device” button can help users to read back these settings from GT-534. In addition, these setting would be read from GT-534 when the “Main Parameter” window pops up from the main menu.

4.4.1 Phone /Periodic report/Alarm

The following page is “Phone/Periodic Report/Alarm”. Users can refer the explanation below :

The screenshot shows the 'Device Parameters' window with the following details:

- Machine Information:** Machine ID: GT-534, SIM Card Number: (empty)
- Data Log:** Enable Data log, Interval(1~99999s): 300
- Phone Number:** A table with 10 rows (Phone 1 to Phone 10). Each row has input fields for the phone number and checkboxes for Command, DTMF, Auto, and Event. Phone 1 has all checkboxes checked. Each row also has an 'Event Setting' button.
- Auto-Report:** Enable Auto-Report, Report Interval: 1 day, Report Time: 0 : 0 : 0
- Power Down Alarm:** Enable Alarm, After Power Down: 0 min
- Low Battery Volume Alarm:** Enable Alarm, Alert Voltage(mV): 3570, Alert Percent(%): 10

1. Machine ID

The device ID would be shown in the report and alarm SMS messages. It can be used for recognizing the GT-534. The length of characters is 20 without supporting Unicode and “;” characteristic.

2. SIM Card Number

This text field can show or input the phone number of the plug-in SIM card. Take Taiwan for example: 0928xxxxxx. If the phone number is international number, the “international prefix number” and “national number” must be added in the front of phone number. For example: 002-86-928xxxxxx.

3. Data log

The users can select to enable or disable data log function, and set the

time interval of data log which the minimum setting is 1 sec. The GT-534 will delete older file when the free size of SD card is less than 50MB. The format of data log as below:

Date,Time,DI0, DI1, DI2, DI0, DI0, DI0, DO0, DI1,AI

4. 1~ 10 Phone umbers

This field is used to set which phone numbers to receive SMS/voice message or send SMS command. Every phone number can be set the authority as follows.

- (1) Command: Authority to send the SMS commands to GT-534
- (2) DTMF: Dual-Tone Multi-Frequency, the user can control DO by DTMF.
- (3) Counter Report: Authority to receive the counter SMS report periodically.
- (4) Event: Authority to receive the event SMS report

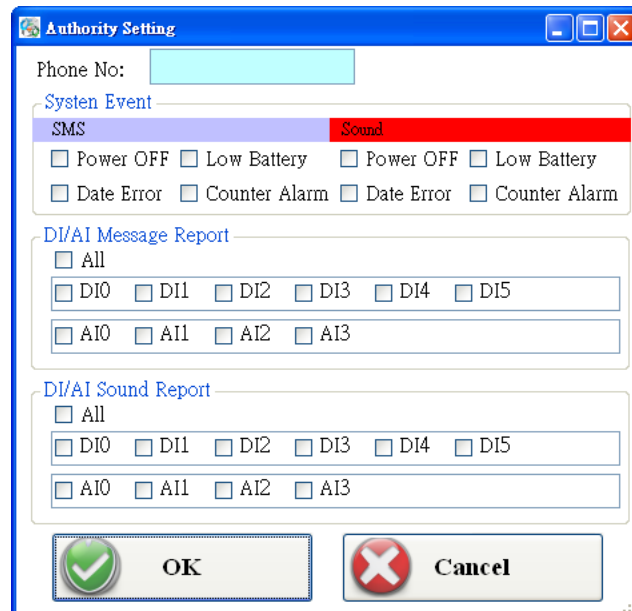

1. System Event: SMS or Sound event of system
2. DI/AI Message Report: SMS message of DI or AI event
3. DI/AI Sound Report: Sound message of DI or AI event

5. Auto-Report

- (1) Enable Auto-Report: Enable the function in this item.
- (2) Report Interval : The time interval for counter report and it is set by day (1 ~ 31 days)
- (3) Report time : Hour/Minute/Second

Note: The SMS format of counter report is fixed. It can not be modified by users:

CRPT;Machine ID;Report Date;Report Time;DI0;DI1;DI2;DI3;DI4;DI5

Text field :

CRPT : Counter report

Machine ID : GT-534 ID

Report Date : Report date (The format is YYYYMMDD (YYYY=year, MM=month, DD=day))

Report Time: Report time (The format is HHMMSS (HH=hour, MM=minute, SS=second))

DI0 ~ DI5: The counter values of DI0 ~ DI5.

If these DI channels are not set as counter mode, the counter value would be zero

Note:

If CRPT function is enabled and the return time is changed, the next time to send the SMS report is re-calculated according to the current time of GT-534 and the CRPT time. There would 2 conditions on the day:

- (1) When the GT-534 time is over the CRTP time, GT-534 would send the CRTP SMS after 1 minute.
- (2) If the GT-534 time does not reach the CRTP time, GT-534 would not send the CRTP SMS until GT-534 time reaches the CRTP time.

6. Power Down Alarm

The function supports to send alert SMS when the external power is off. The alert time after the event happened can be set by minutes (0 ~ 60 minutes).

7. Low Battery Volume Alarm

The function supports to send alert SMS when the volume of battery is low. The low battery value can be set as 10%~ 50% less than total volume.

4.4.2 DI mode and SMS content

Another page in “Device parameter” is about DI and event setting. The explanation is below:

1. The format of event Shot Message:

The format of event SMS can be modified by users by the check boxes. The complete format of even SMS is below:

ALARM;Machine ID;Report Date;Report Time;Event Message

ALARM : Indicate alarm report

Machine ID : Device ID

Report Date : Report date (The format is YYYYMMDD (YYYY=year, MM=month, DD=day))

Report Time: Report time (The format is HHMMSS (HH=hour, MM=minute, SS=second))

Event Message : User-defined content

The three messages of event SMS can be set or canceled by users to match various applications. They include:

- (1) Disable SM Title: Enable the function. The title string “ALARM” would not be sent in SMS
- (2) Disable MID: Enable the function. The machine ID would not be sent in SMS
- (3) Disable report Data/Time: Enable the function. The data and time would not be sent in SMS
- (4) Disable ID: Disable this function. A check ID would be sent in SMS and

custom can use ICPDAS's SMS management software (GT-534 SMS Database System software).

2. Show System Event

The window shows the system event message according to the selected language. The content is fixed and can not be changed. There are 4 system events in GT-534 as follows:

- (1) Event 1 : The external power is off. (This function can be disabled)
- (2) Event 2 : The volume of battery is lower than the setting value. (This function can be disabled). n is the remaining percentage volume of battery.
- (3) Event 3 : The time of GT-534 is abnormal. This function can not be disabled. It could make the wrong timing for report and the cause is the silver battery of GT-534 is abnormal. After changing the silver battery, the time of GT-534 must be set.
- (4) Event 4: The counter value is reaching the preset limits. This function can be disabled. n represents the number of DI channel. (n: 0 ~5)
- (5) Sound upload: Users can upload sound file to SD card. If the file has existed, it shows "OK". If it doesn't exist , it shows "N/A"

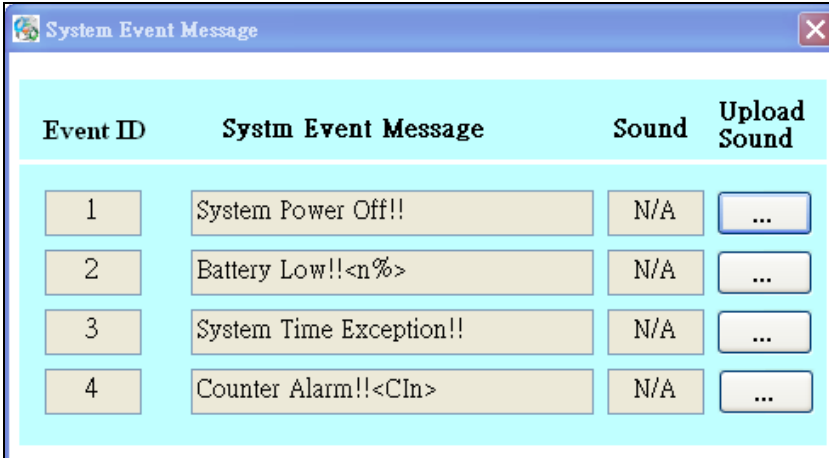

Event ID	System Event Message	Sound	Upload Sound
1	System Power Off!!	N/A	...
2	Battery Low!!<n%>	N/A	...
3	System Time Exception!!	N/A	...
4	Counter Alarm!!<CIn>	N/A	...

3. DI type

There are 3 modes of DI type for users to select. It needs to reset GT-534 to enable new setting after changing these parameters.

- (1) Use: Enable DI function
- (2) Type: DI0 ~ DI5 could be set as Counter function, NC or NO mode .
 - ◆ Counter : Counter function (frequency : 5 ~ 40Hz)
 - ◆ DI-NC : Normal Close mode. When the DI circuit is broken, the event is triggered. GT-534 would send the alarm SMS. Refer to section 2.4.2 for the detail.
 - ◆ DI-NO : Normal Open mode. When the DI circuit is shorten, the event is triggered. GT-534 would send the alarm SMS. Refer to section

2.4.3 for the detail.

- (3) Trigger Time(sec) : Set the hold time of the DI triggered signal (0~9999 seconds)
- (4) DO ON : This function enable DO output when the DI event is triggered.
- (5) DO ch.: Set the DO channel.
- (6) Time(sec) : Set the output time of DO channel (0~999 seconds). If the power is just provided by Li-battery, GT-534 would not be into sleep mode until the output time is reaching.
- (7) Event message: Set the user-defined message content. These message would be included in event SMS.
checked "Open GeoSMS Format", SMS will be sent in Open GeoSMS Format (with GPS data)

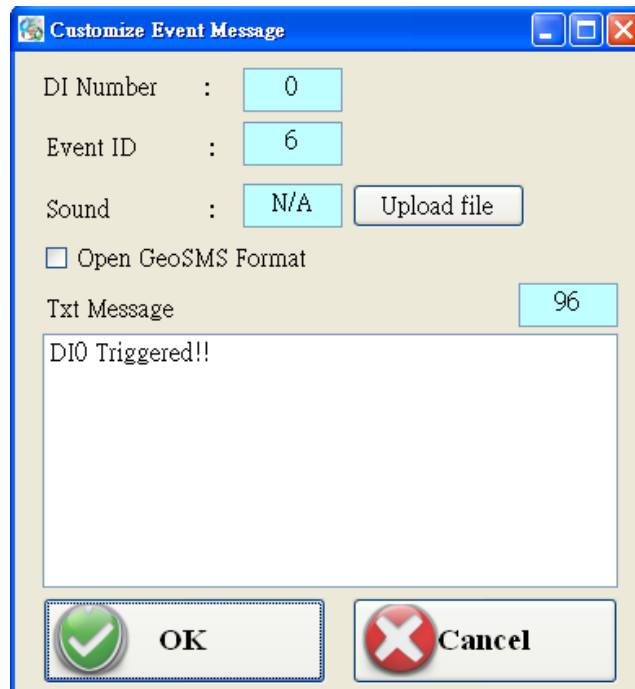

4. AI type

There are 2 modes of AI type for users to select.

- (1) Use: Enable AI alarm function
- (2) Type: AI_H1, AI_H2, AI_L1, AI_L2 could be set as high alarm or Low alarm mode.
 - ◆ Upper Limit: Set AI as over alarm.
 - ◆ Lower Limit: Set AI as low alarm.
- (3) Value: AI alarm value
- (4) Trigger Time(sec): Set the hold time of the AI triggered signal (0~9999 seconds)
- (5) Reset time (sec): Set the time when the AI needed to restore the number of seconds (0~999).

- (6) DO ON: This function enable DO output when DI event is triggered.
- (7) DO ch.: Set the DO channel.
- (8) Time (sec) : Set the output time of DO channel (0~999 seconds). If the power is just provided by Li-battery, GT-534 would not be into sleep mode until the output time is reaching.
- (9) Event message: Set the user-defined message content. These message would be included in event SMS.
checked "Open GeoSMS Format", SMS will be sent in Open GeoSMS Format (with GPS data)

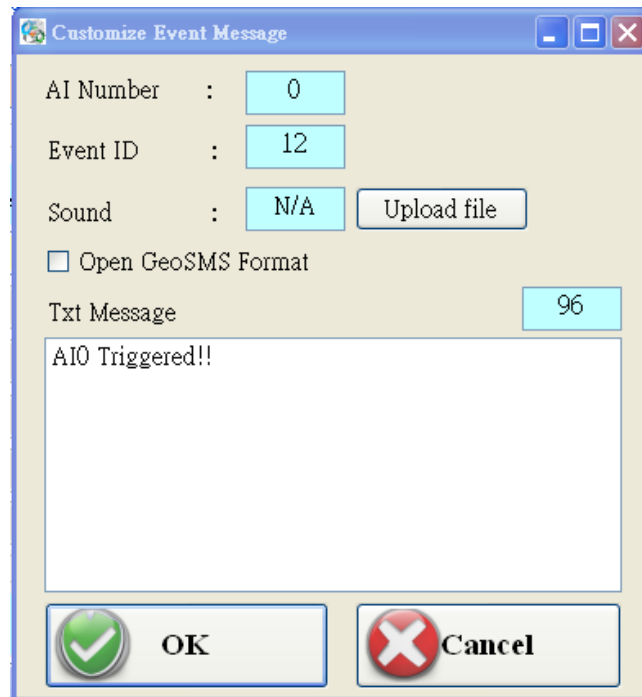

4.4.3 Import/Export Parameters

Users can use the import and export functions from the menu bar. This function would be enabled when the “Device Parameter” window is open.

The explanation is below:

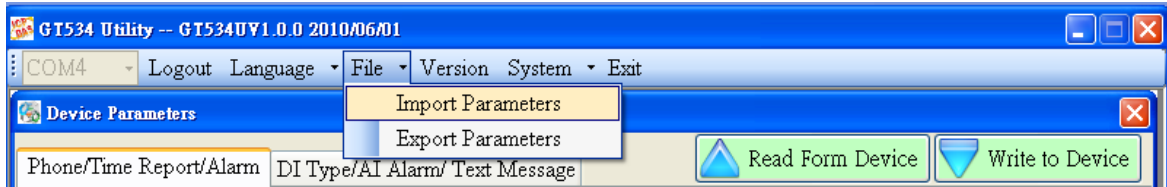

- A. Import Parameters : This function is used for reading back the setting of device parameters from .par file and displaying in “Device parameter” window. When press “import” button, a file selection window would pop up for users to choice the .par file.
- B. Export Parameters: The function is used for saving the setting of “Device parameter” window as .par file. When press “Export” button, a file selection window would pop-up for users to save the setting as .par file in specific path.

4.5 SMS Recorder

This window provides the inquiring, saving and deleting counter value, and event SMS record function.

4.5.1 Counter Report record

In this page, users can inquire the record of CRPT reports:

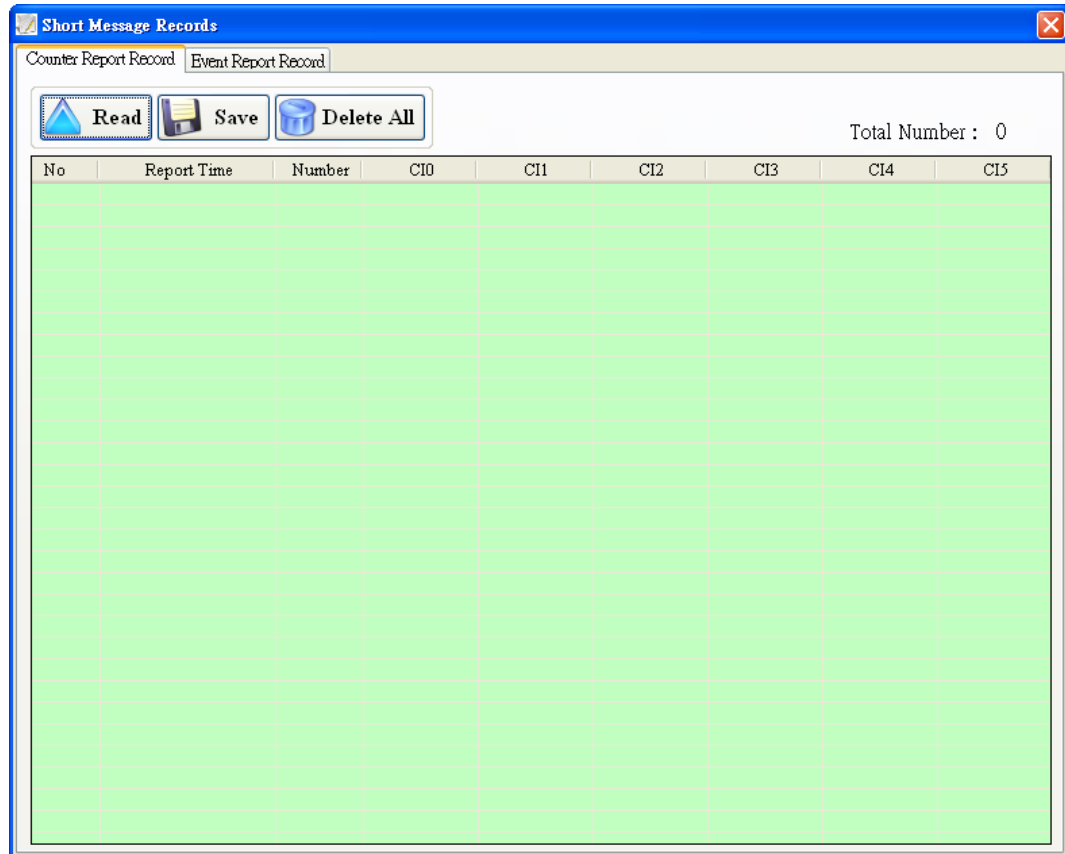

Operation:

- (1) Read: Read all the CRPT report from GT-534. The maximum number of CRPT report record is 64.
- (2) Save : Save these records to a file (*.csv).
- (3) Delete all : Delete all CRPT report records from GT-534.

Text field :

- (1) No: The number of RTCP records.
- (2) Report time : CRPT report time.
- (3) Number: It represents the SMS sending to the quantity of phone numbers.
- (4) CI0 : The DI0 counter value. If the DI is not set as counter, the value is 0.
- (5) CI1 : The DI1 counter value. If the DI is not set as counter, the value is 0.
- (6) CI2 : The DI2 counter value. If the DI is not set as counter, the value is 0.
- (7) CI3 : The DI3 counter value. If the DI is not set as counter, the value is 0.
- (8) CI4 : The DI4 counter value. If the DI is not set as counter, the value is 0.
- (9) CI5 : The DI5 counter value. If the DI is not set as counter, the value is 0.

4.5.2 Event Report record

In this page, users can inquire all event report of GT-534. The explanation is below:

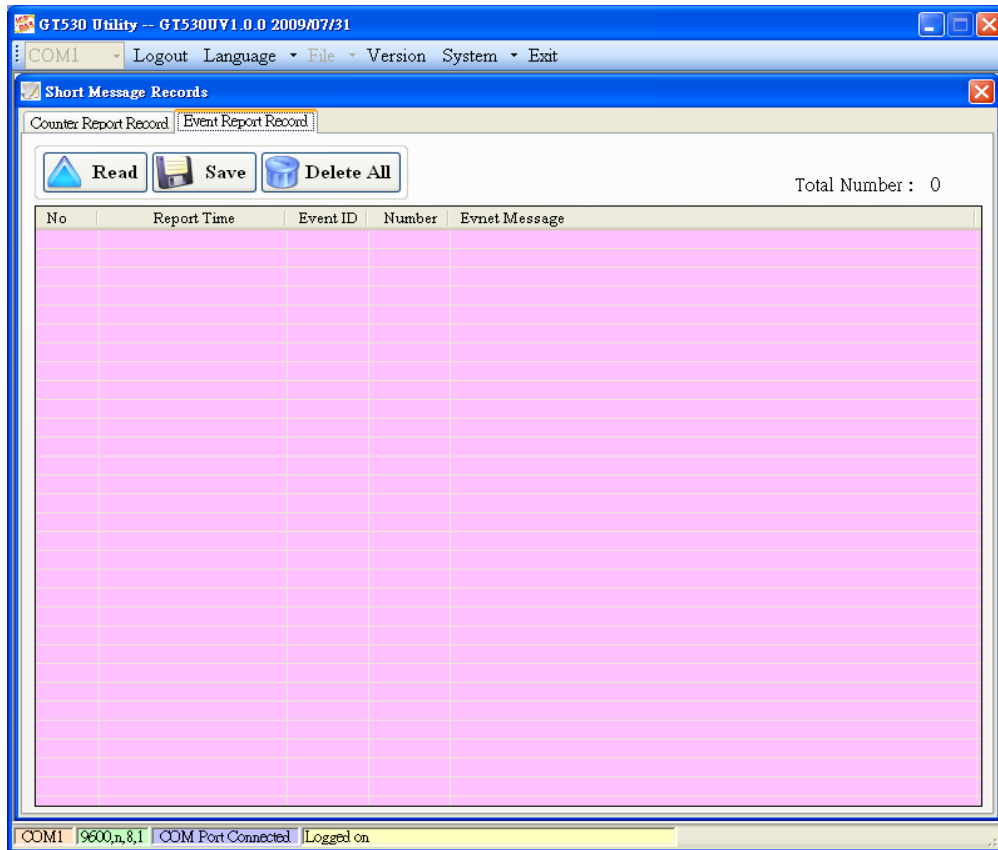

Operation :

- (1) Read: Read all the CRPT report from GT-534. The maximum number of CRPT report records is 64
- (2) Save : Save these records to a file.
- (3) Delete all : Delete all event report records of GT-534.

Text field :

- (1) No. : Record number
- (2) Report time : Event report time of GT-534
- (3) Event ID : Event identification
- (4) Number : The SMS quantity sent to the defined phone numbers
- (5) Event message : The event content

4.6 Device Time

This window provides the function to inquire and modify the time of GT-534. Besides, the next and last report times are also shown. The text field operation is below.

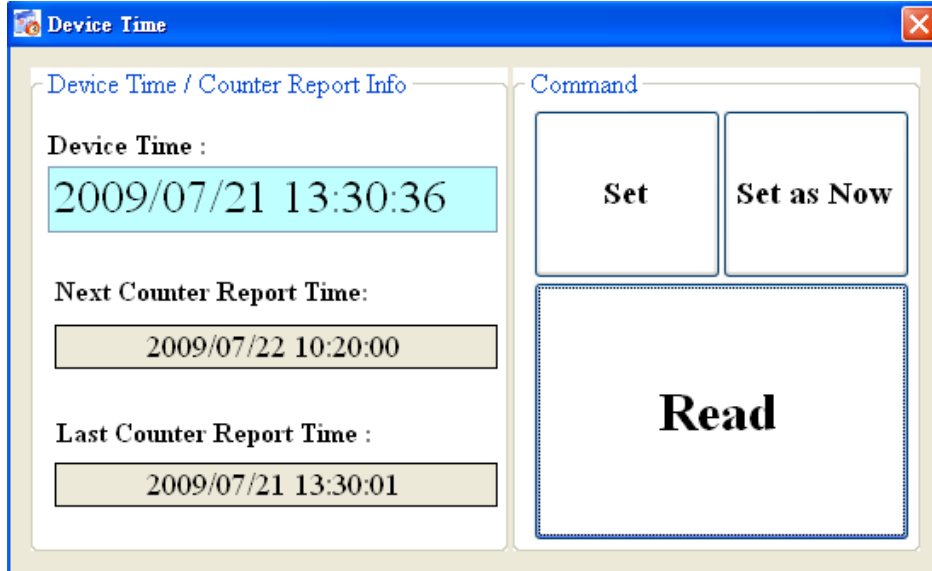

Text field :

- (1) Device time: show the time of GT-534. Users also can change the time in this field to key in the specific time.
- (2) Next Counter Report Time : show the next CRPT time
- (3) Last Counter report time : show the last CRPT time

Operation:

- (1) “Set as Now”: Set the PC time to GT-534. After setting the time successfully, the information of GT-534 time and CRPT report time would be updated.
- (2) Set: Set the GT-534 time according the “Device Time” field. After setting the time successfully, the information of GT-534 time and CRPT report time would be updated.
- (3) Read: Read back the time of GT-534, the next report time and the last report time.

Note:

If the counter report function is enable and reset the time of GT-534, the next time to send the SMS report is re-calculated according to the current time of GT-534 and the CRPT time. There would 2 conditions on the day:

- (1) When the GT-534 time is over the CRPT time, GT-534 would send the CRPT SMS after 30 seconds.
- (2) If the GT-534 time does not reach the CRPT time, GT-534 would not send the CRTP SMS until GT-534 time reaches the CRPT time.

4.7 Counter Value

The window provides the function to inquire and modify the counter values of DI0 ~ DI5. The explanation of operation and text field is below:

Name	Value	Set Value	Counter Alarm	Alarm Value
DI 0	0 0 0 0 0 0 0 0 0 0	0	<input type="checkbox"/> Enable	+ 0
DI 1	0 0 0 0 0 0 0 0 0 0	0	<input type="checkbox"/> Enable	+ 0
DI 2	0 0 0 0 0 0 0 0 0 0	0	<input type="checkbox"/> Enable	+ 0
DI 3	0 0 0 0 0 0 0 0 0 0	0	<input type="checkbox"/> Enable	+ 0
DI 4	0 0 0 0 0 0 0 0 0 0	0	<input type="checkbox"/> Enable	+ 0
DI 5	0 0 0 0 0 0 0 0 0 0	0	<input type="checkbox"/> Enable	+ 0

Read Set Value Set Alarm

Text field :

- (1) Name: The DI name of DI0 ~ DI5 .
- (2) Value : The current counter value (maximum: 999999999)
- (3) Set Value: Input the defined counter value. The maximum is 999999999. This field is enabled when DI is set as counter mode.
- (4) Counter Alarm: Enable the counter alarm.
- (5) Alarm Value: Counter alarm value= current value+ alarm value. This field can not be 0

Operation:

- (1) Read : Read the current counter value and alarm settings from GT-534. If the counter is not set as counter,the counter value is 0.
- (2) Set Value : Change the counter value into GT-534 according to the "Set Value" field
- (3) Set Alarm : Set the counter alarm into GT-534.

4.8 Change Password

This window provides the function of changing login password. The default password is “111111”. This password is also applied in SMS command to GT-534. These SMS commands are described in chapter 5.

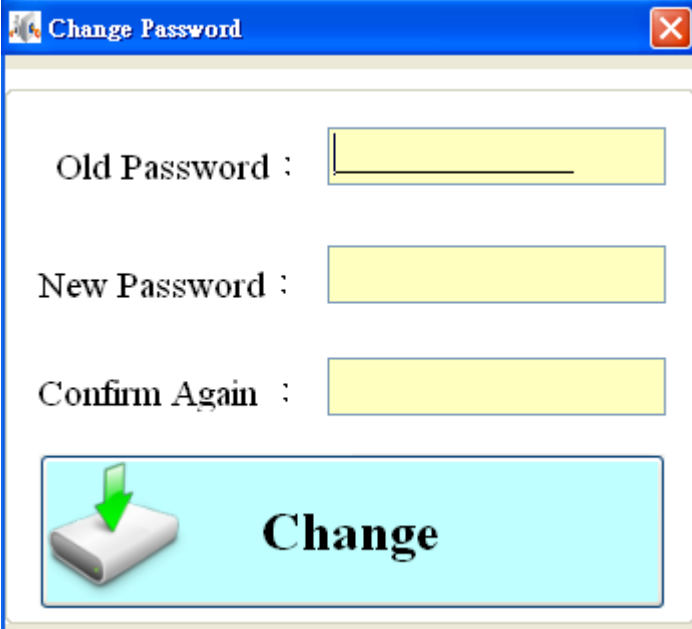

The screenshot shows a window titled "Change Password" with a blue border and a close button in the top right corner. Inside the window, there are three text input fields stacked vertically. The first field is labeled "Old Password :", the second "New Password :", and the third "Confirm Again :". Below these fields is a large, light blue button with a green arrow icon pointing down and the word "Change" in bold black text.

Text field:

- (1) Old password: Input the current password.
- (2) New password: Input the new password (maximum : 12 characters)
- (3) Confirm Again : Input new password again.

Operation

- (1) Change: Updated the password.

4.9 DO control/DI/AI status

The function is used for controlling DO and reading the status of DIs and AI:

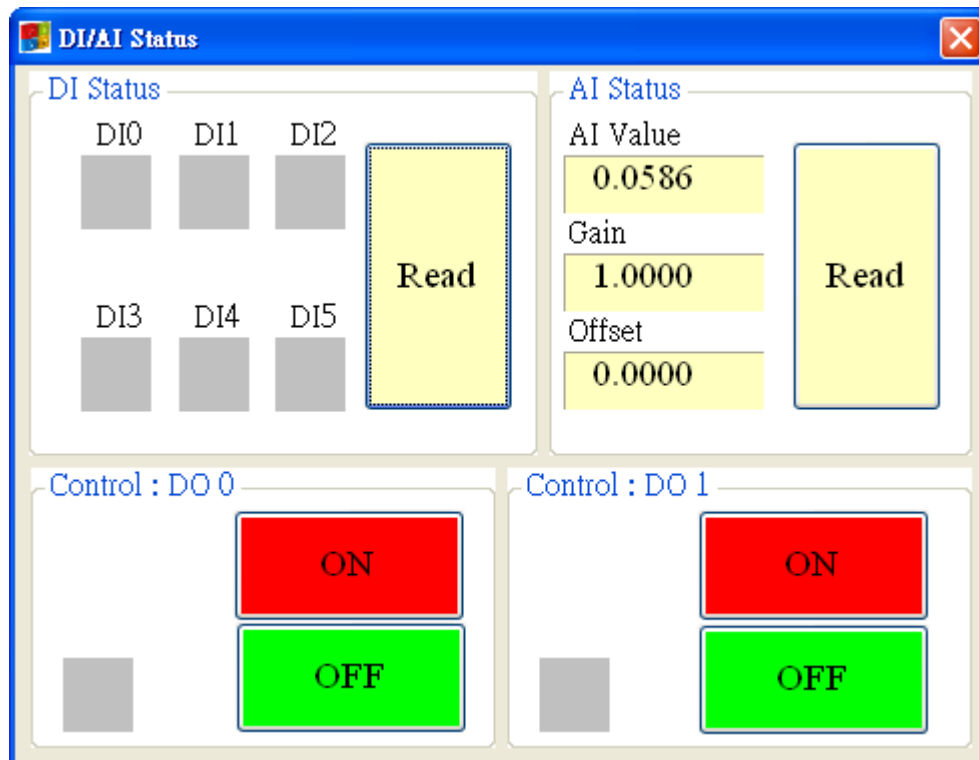

Text field

(1) DI:

1. Grey : the voltage logic is high.
2. Red : the voltage logic is low

(2) AI:

1. Value: AI value of the current.
2. Gain: User can not change this value.
3. Offset: User can not change this value.

(3) DO:

1. DO0 ~ DO1 ON : Set the DO output on
2. DO0 ~ DO1 OFF : Set the DO output off

4.10 SD/Battery information

This function provides users to check free size of SD card and the remaining volume of battery.

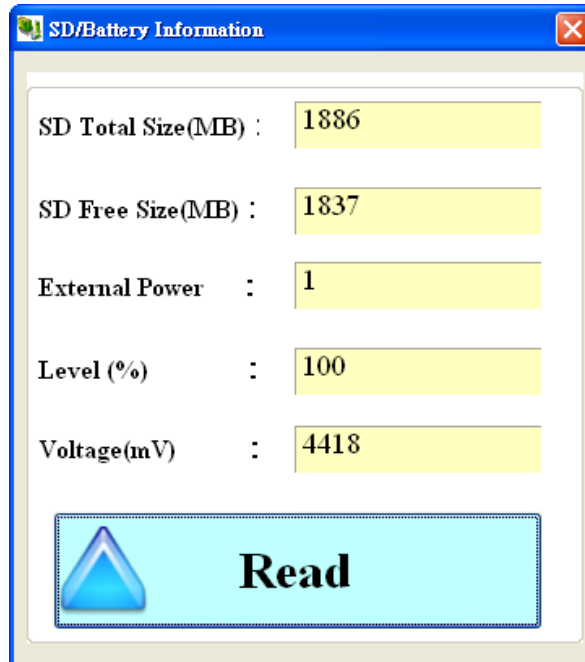

Text field

- (1) SD Total Size: Shows the current device's SD Card GT-534 the total capacity, the size of the total capacity will be displayed with the PC side or the SD will be slightly different specifications, such as display 0 so that SD is not installed or not initialized.
- (2) SD Free Size: Shows the current SD card free space, such as display 0 so that SD is not installed or not initialized.
- (3) External Power: The external power is on or off. (1- on, 0-off). It needs to open the external power when using utility to configure GT-534.
- (4) Level: Show the percentage of battery volume. If the battery is not connected to GT-534. The value is about 60%
- (5) Voltage: The voltage value of battery. If the battery is not connected to GT-534. The value is about 3925 mV

Operation

- (1) Read: Read the above information from GT-534.

4.11 Signal Quality & GPS data

This window can show GSM signal strength, and GPS data.

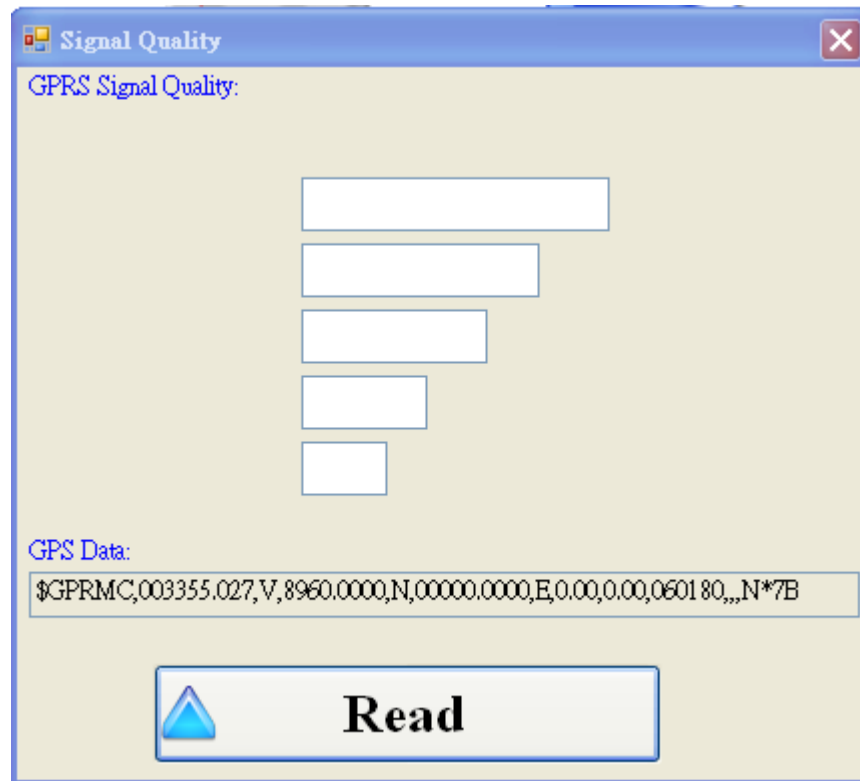

GPRS Signal Quality field :

The strength is divided into 5 sections shown in percentage.

GPS Data field :

Show GPS data.

Operation :

- (1) Read : Read the GSM signal strength and GPS data.

4.12 Version

Press "Version" in tool menu, and the window would show the version of Utility and firmware.



Text field:

- (1) Firmware version: show the version information of GT-534's firmware
- (2) Utility version: show the version information of GT-534's utility

Operation:

Read: Read this information from GT-534.

4.13 System

“System” menu item has 2 functions of recovering factory setting and resetting GT-534

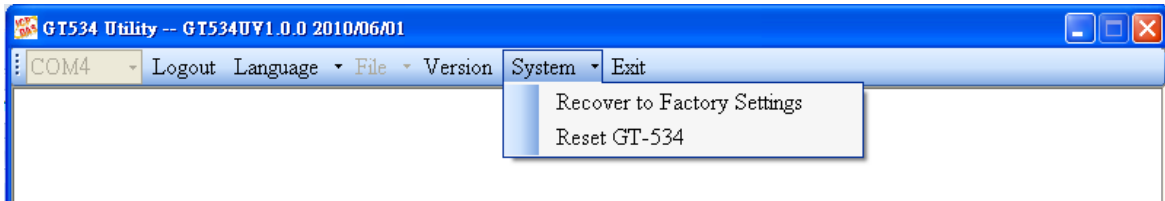

4.13.1 Recover to Factory Settings

The function is used to recover GT-534 as factory settings including password. The steps are below:

- (1) Select the Recover to Factory Settings.

4.13.2 Reset GT-534

The function is used to reset GT-534 by software.

- (1) Make sure STA led is blanking per 1 second
- (2) Select “Rest GT-534” button to reset GT-534.

5. SMS Command

These SMS commands help users to control or get the information of GT-534. GT-534 can only receive these commands according to the phone numbers set in GT-534. These phone numbers must be set to have “Allowed” authority. If the phone number is not in the list, GT-534 would not reply to any command.

Command Table

SMS command	Description
@TIME	Time set and inquiry
@DOCn	DO control
@ACTV	Counter value inquiry
@DIV	DI/DO inquiry
@AIV	AI inquiry
@BAT	Battery inquiry
@SD	The free size of SD card inquiry
@PASS	Password inquiry

5.1 @TIME (Time set and inquiry)

(1) Description :

This command is used to set or inquire the time of GT-534.

(2) Request :

Set

@TIME;YYYYMMDD;HHMMSS

Inquiry

@TIME

Format

YYYYMMDD : YYYY=year, MM=month, DD=day

HHMMSS : HH=hour, MM=minute, SS=second

Example:

Set the time as 2010/06/10 10:03:00 :

@TIME;20100610;100300

Inquiry the time:

@TIME

(3) Response

!MID;TIME;Result;YYYYMMDD;HHMMSS

MID : Machine ID

TIME : Command name

Result : command result

◆ OK → command is OK

◆ ER → The format is wrong or authority is not allowed

YYYYMMDD : YYYY=year, MM=month, DD=day

HHMMSS : HH=hour, MM=minute, SS=second

Example :

!GT-534;TIME;OK;20090410;100300

5.2 @DOCn (DO control)

(1) Description :

Set DO0 and DO1 output

(2) Request :

Command: @DOCn;Password;CMD;Second

n : 0 ~ 1 (0-DO0, 1-DO1)

Password : login password

CMD :

- ◆ ON → set DO on
- ◆ OFF → set DO off
- ◆ PLUS → The DO channel is set to on during the defined time.

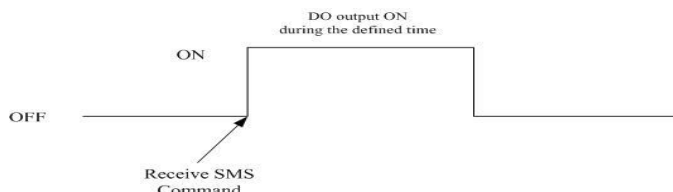

Second : The command is used for PLUS mode. (0~999 seconds)

Example

Set DO1 output to on:

@DOC1;ON

Set DO1 output to on during 20 seconds:

@DOC1;PLUS;20

(3) Response :

!MID;DOCn; Result; CMD;Second

MID : Machine ID

DOC : command name

n : 0 ~ 1 (0- DO0, 1-DO1)

Result : command result

- ◆ OK → command is successfully
- ◆ ER → The format is wrong or authority is not allowed

CMD 、 Second :

The same as the above description.

Example :

!GT-534;DOC1;OK;ON

!GT-534;DOC1;OK;PLUS;20

5.3 @ACTV (Counter value inquiry)

(1) Description :

Inquire the counter values of DI0 ~ DI5

(2) Request :

Inquire

@ACTV

Example

Inquire the 6 current counter values of GT-534.

@ACTV

(3) Response :

!MID;ACTV;Result;DI0;DI1;DI2;DI3;DI4;DI5

MID : Machine ID

ACTV : command name

Result : command result

◆ OK → No error

◆ ER → The format is wrong or authority is not allowed

DI0 : The DI0 counter value. If the DI is not set as counter, the value is 0.

DI1 : The DI1 counter value. If the DI is not set as counter, the value is 0.

DI2 : The DI2 counter value. If the DI is not set as counter, the value is 0.

DI3 : The DI3 counter value. If the DI is not set as counter, the value is 0.

DI4 : The DI4 counter value. If the DI is not set as counter, the value is 0.

DI5 : The DI5 counter value. If the DI is not set as counter, the value is 0.

Example :

!GT-534;ACTV;OK;3;3;3;3;3;3

5.4 @DIV (DI/DO inquiry)

(1) Description :

Inquiry the status of 6 DI and 2 DO.

(2) Request :

Inquiry

@DIV

Example

Inquiry the status of 6 DI and 2 DO :

@DIV

(3) Response :

!MID;DIV; Result;DI0;DI1;DI2;DI3;DI4;DI5;DO0;DO1

MID : Machine ID

DIV : command name

Result : command result

◆ OK → command successfly

◆ ER → The format is wrong or authority is not allowed

DI0~DI5 : The status of DI channels

◆ 1 → Low Voltage

◆ 0 → High Voltage

DO0 ~ DO1 : The status of DO channel

◆ 1 → High Voltage

◆ 0 → Low Voltage

Example :

!GT-534;DIV;OK;0;0;0;0;0;0;1;0

5.5 @AIV (DI/DO inquiry)

(4) Description :

Inquiry the Value of AI.

(5) Request :

Inquiry

@AIV

Example

Inquiry the Value of AI:

@AIV

(6) Response :

!MID;AIV; Result;AI value; AI value(calibration);Gain;Offset

MID : Machine ID

AIV : command name

Result : command result

◆ OK → command successfly

◆ ER → The format is wrong or authority is not allowed

AI value: Real value of AI

AI value(calibration): Calibration value of AI

Gain:Gain

Offset:Offset

Example :

!GT-534;DIV;OK;0.053;0.002;1.0000;0.000

5.6 @BAT (Battery inquiry)

(2) Description :

This command is to inquire the information of battery.

(3) Request :

Inquiry

@BAT

Example

inquire the information of battery :

@BAT

(4) Response :

!MID;BAT;Result;Pext;Percent;Voltage

MID : Machine ID

BAT : command name

Result : command result

- ◆ OK → command successfully
- ◆ ER → The format is wrong or authority is not allowed

Pext : the status of the external power

- ◆ 0 → OFF
- ◆ 1 → ON

Percent: The percentage of battery volume (%)

Voltage: The voltage value of battery (mV)

Example :

!GT-534;BAT;OK;1;57;3899

5.7 @SD(Information of SD card)

(5) Description :

This command is to inquire the information of SD card.

(6) Request :

Inquiry

@SD

Example

inquire the information of SD card :

@SD

(7) Response :

!MID;SD;Result;SDisOK;SDTotalSize;SDFreeSize

MID : Machine ID

SD : command name

Result : command result

◆ OK → command successfully

◆ ER → The format is wrong or authority is not allowed

SDisOK : the status of the SD Card

◆ 0 → No SD Card

◆ 1 → OK

SDTotalSize: The total size of SD card(MB)

SDFreeSize: The free size of SD card(MB)

Example :

!GT-534;SD;OK;1988;1952

5.8 @PASS(Password inquiry)

(1) Description :

If you forget the password, you can use this command to inquire password. The phone number must be set the authority of "SMS Command".

(2) Request :

Inquiry

@PASS

Example

Inquire the password of GT-534 :

@PASS

(3) Response :

!MID;PASS;Result;Password;Password

MID : Machine ID

PASS : command name

Result : command result

◆ OK → Inquire successfully

◆ ER → No authority

Password : the current password

Example :

!GT-534;PASS;OK;111111;111111

6. Send/Receive SMS and Call out by COM

GT-534 provides sending/receiving SMS function from COM 1. This function can provide PLC or PAC to send or receive SMS through GT-534. That can extend GT-534 to various applications.

COM port setting

- ◆ Baud rate : 115200 bps
- ◆ Data bit : 8
- ◆ Parity check : none
- ◆ Stop bit : 1
- ◆ Flow control : none

6.1 Send data to COM port of GT-534 by SMS command

It is possible to use SMS to send data to com port of GT-534. The command header is”+++”. The first setting phone number just has the authority to use this function with the “Allowed” enabling. The command support 7 Bits format. Both of RS-232 and RS-485 will receive data.

Command :

+++Message

Message : The message is sent to com1 of GT-534 (Maximum 130 char)

Exmample

SMS content : +++Hello

To com port : Hello

6.2 Sending SMS by COM(RS-232/RS-485)

This function is used to send SMS to the first setting phone number by this command”+++”. This command supports ASCII code, not Unicode

Request :

+++Message,

Message : The user-defined SMS content and the end of the message have to add ASCII code 0x0d.

Example :

Command from com1 : +++Hello

Received SMS content : Hello

6.3 Sending Sound by COM (RS-232/RS-485)

The GT-534 can call out through the command, this mode must be specified telephone voice file to play, and voice files must be placed in the root directory of

SD card

Command format:

@CALL;Phone number;Wav file name(0x0d)

@CALL:command name

Telephone number: the receiver's phone number, if you want to make international calls, need to add "+" and country code

Wav file name: When it is necessary to play the audio file, file name cannot exceed 6 characters, and the file name and extension, and the case must be the same with the SD card.

Example :

@CALL;0912XXXXXX;CALL01.WAV(0x0d)

7. Data Records and Audio file format

The GT-534 have data log and play audio file with SD card, this chapter will present information on record formats and audio file format acceptable.

7.1 Data Records Format

When DI is HIGH, the record value of 1, when the DI is LOW, the record is 0; the following are examples of Data log format

Data	Time	DI0	DI1	DI2	DI3	DI4	DI5	DO0	DO1	AI
20100525	151520	0	0	0	0	0	0	0	0	0.044
20100525	151521	0	0	0	0	0	0	0	0	0.044

Data log file will be placed in the SD of the Data log folder, placed according to years, when the SD card capacity of less than 50MB, it will delete the older data, have ensured that new information may continue to record.

7.2 Audio File Format

GT-534 voice telephony functions, through the play SD card Audio files to voice alarm, the user can upload Audio files by Utility, or the voice file is too large, users are recommended to choose copy audio files into the SD card by the card reader, the following is the voice file name corresponding to the event:

RDI0.WAV~RDI5.WAV	DI0~DI5
RAI0.WAV~RAI3	AI_H1: RAI0.WAV AI_H2: RAI1.WAV AI_L1: RAI2.WAV AI_L2: RAI3.WAV
ANSWER.WAV	When call is connected,it will play this file
OK.WAV	When DTMF is success,it will play this file
ERROR.WAV	When DTMF is Failure,it will play this file

The following WAV file format needed

File type	*.Wav
Audio type	PCM
Data bit	16 bits
Channel	Single track
Sample rate	8 kHz,11 kHz

8. DO output by DTMF

Dual-Tone Multi-Frequency(DTMF), this technology is through the local telephone or cell phone to make and receive voice calls at the time, from the keyboard, press the 0 to 9, *, # these keys, it will transmit through the encoding to the GT-534. Command length is 3 or 5 characters, the command divided into three mode: output DO, DO turn off, and the DO output with the PLUS, the following description of the command.

key	function
1	DO's channel
2	Control mode : 0 : off 1 : on 2 : PLUS
3 and 4	The command is used for PLUS mode (0~99 sec),the DO will open, and than Do close after this time.
5	End char

If the input format is correct, it will return the voice which is smae as OK.WAV, and If the input format is error, it will return the voice which is smae as ERROR.WAV.

Example:

1. DO0 output

keyin 0 1 #

2. DO1 close

keyin 1 0 #

3. DO0 output 10 sec

keyin 0 2 1 0 #

9. Troubleshooting

Item	Trouble state	Solution
1	EXT LED is off without Li-battery	Please check the external power and wire connection.
2	STA is always on	Check SIM card Check Antenna Check the GSM signal strength
3	GT-534 Utility cannot connect to GT-534	Check STA LED blinking every 1 sec Check com port connection and baud rate setting
4	After event triggering, users can not receive SMS.	Check DI connection Check phone number and format Check DI event is enabled in GT-534 Utility
5	Counter value is abnormal	Check wire connection Check the counter signal is at 5~40Hz. Check the DI mode setting. Must be counter mode.
6	The content of received SMS is abnormal.	Please select the correct language to set the content of SMS in utility. If you want to transfer Unicode char, select the language supporting UCS2.
7	The time of receiving SMS is abnormal.	1. The time in GT-534 is abnormal. Setup the time of GT-534 by utility. 2. The battery of RTC is low. Change the silver battery of RTC. After changing the battery, set the time of GT-534.
8	STA led is blanking per 50 ms	The pin code is wrong. The login windows would show the field to input PIN or PUK code
9	Forget Password	Use SMS command to get the password.