

# GW-7553 PROFIBUS/Modbus TCP Gateway

## User's Manual



High Quality, Industrial Data Acquisition, and Control Products

## **Warranty**

All products manufactured by ICP DAS are under warranty regarding defective materials for a period of one year from the date of delivery to the original purchaser.

## **Warning**

ICP DAS assumes no liability for damages resulting from the use of this product. ICP DAS reserves the right to change this manual at any time without notice. The information furnished by ICP DAS is believed to be accurate and reliable. However, no responsibility is assumed by ICP DAS for its use, or for any infringements of patents or other right of third parties resulting from its use.

## **Copyright**

Copyright 2013 by ICP DAS. All rights are reserved.

## **Trademark**

The names used for identification only may be registered trademarks of their respective companies.

## **List of Revision**

<b>Date</b>	<b>Author</b>	<b>Version</b>	<b>Revision</b>
<b>2012/05/10</b>	<b>Ryan</b>	<b>1.33</b>	<b>Release</b>
<b>2013/05/30</b>	<b>Elliot</b>	<b>1.34</b>	<b>Release</b>

# Table of Contents

<b>1. Introduction</b>	<b>4</b>
1.1 Features	5
1.2 Modules Support	5
1.3 Specification	5
<b>2. Hardware</b>	<b>7</b>
2.1 Block Diagram of GW-7553	7
2.2 Pin Assignment	7
2.3 Wiring	9
2.4 Setting the PROFIBUS Address	12
2.5 LED status indicator	13
2.6 Normal/Setting DIP switch	15
<b>3. Communication protocol transfer theorem</b>	<b>16</b>
3.1 PROFIBUS data exchange	16
3.2 Modbus data exchange	19
3.3 Communication protocol transfer	21
3.4 PROFIBUS DP-V1 Acyclic Service	26
<b>4. Communication</b>	<b>30</b>
4.1 Field of application	30
4.2 GSD file	31
4.3 The Configuration of the common parameters	34
4.4 The Configuration of the modules	35
4.5 Diagnostic messages	38
4.6 I/O data exchange	40
4.7 Establish connection with GW-7553	42
4.8 Data exchange example—Modbus RTU	43
4.9 Data exchange example—Modbus TCP	61
<b>5. Application of Utility</b>	<b>72</b>
5.1 Install Utility	72
5.2 Utility introduction	75
5.3 Memory address configuration of the module	77
5.4 Safe value setting	80
5.5 IP setting	81
5.6 Establish connection with GW-7553	83
<b>6. Configuration with Web Browser</b>	<b>86</b>
6.1 Connecting to Web Server	86
6.2 Web Configuration—Function menu	87
6.3 Web Configuration—Setup page	88
<b>7. Troubleshooting</b>	<b>95</b>
<b>8. Dimensions</b>	<b>96</b>

# 1. Introduction

PROFIBUS and Modbus are two kinds of famous protocols and are widely used in the fields of factory and process automation. The GW-7553 is a PROFIBUS to Modbus TCP gateway. By using this module, users can easily put the Modbus TCP devices into PROFIBUS network.

Figure 1 shows an application example for the GW-7553 module.

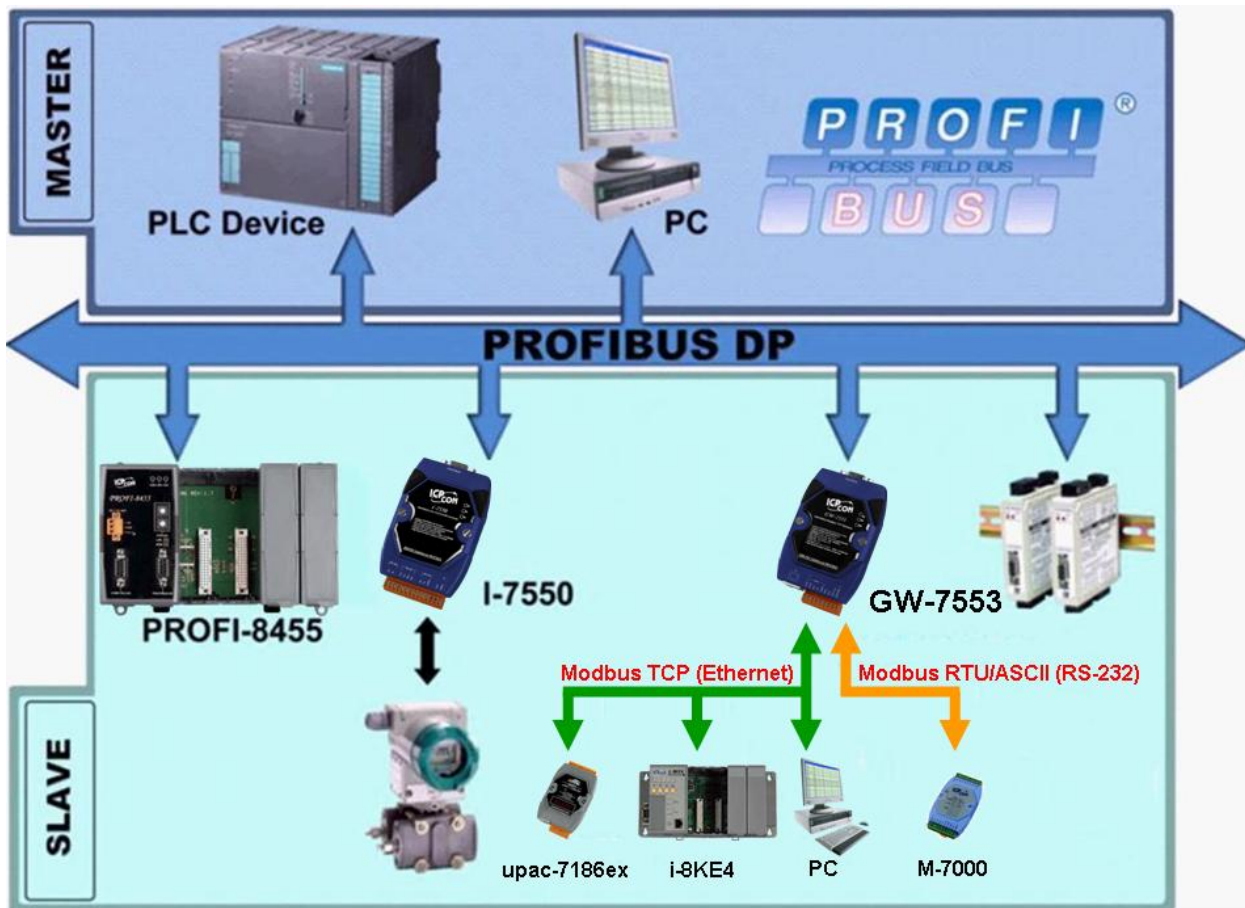

Figure 1 Application architecture of the GW-7553 module

The GW-7553 Gateway is specially designed for the slave device of PROFIBUS DP protocol. In the Modbus protocol application, the GW-7553 can be a Modbus Master device or Slave device. The Modbus devices can exchange data with the PROFIBUS Master device via the GW-7553 module.

The main features and specification of GW-7553 are described as below:

## 1.1 Features

- 16-bit Microprocessor inside with 80MHz
- Profichip VPC3+C PROFIBUS controller
- Support PROFIBUS DP-V0 & DP-V1 slave
- PROFIBUS transmission rate detect automatically
- Max transmission speed up to 12 Mbps for PROFIBUS and 115.2 kbps for COM Port
- Support Modbus RTU, ASCII and TCP format
- Support Modbus Master/Slave mode
- Support safe value setting
- COM Port driver has 1K bytes QUEUE input buffer & 512 bytes QUEUE output buffer
- Max length of output/input data is 240/240 Bytes
- Ethernet Port: 10/100 Base-TX
- 2500Vrms High Speed iCoupler Isolation Protection for PROFIBUS network
- 3000V<sub>DC</sub> Isolation Protection on the PROFIBUS side
- Provide LED indicators
- Built-in Watchdog
- Mountable on DIN Rail

## 1.2 Modules Support

Only the following Modbus commands are supported by the gateway.

*Table 1 Modbus function codes*

Code	Name	Description
01	Read Coil Status	Read the ON/OFF status of discrete outputs in the slave
02	Read Input Status	Read the ON/OFF status of discrete inputs in the slave
03	Read Holding Registers	Read the binary contents of holding registers in the slave
04	Read Input Registers	Read the binary contents of input registers in the slave
05	Force Single Coil	Write a single output to either ON or OFF in the slave
06	Preset Single Register	Write an integer value into a single register in the slave
15	Force Multi. Coils	Write each coil in the sequence of coils to either ON or OFF in the slave
16	Preset Multi. Registers	Write a block of contiguous registers in the slave

## 1.3 Specification

COM Port specs:

- Serial port - RS-232
- Serial port interface: screw terminal block
- Baud Rate : 2400/4800/9600/19200/38400/57600/115200 bps

- Data Format: 7/8 data bits, None/Odd/Even parity bit, 1/2 stop bit

PROFIBUS specs:

- PROFIBUS interface connector: D-Sub 9-pin female
- Baud Rate: 9.6k/19.2k/45.45k/93.75k/187.5k/500k/1.5M/3M/6M/12Mbps
- Address Setting: 0~126 (set by DIP switch or EEPROM)

Ethernet specs:

- 10/100Base-TX (Auto-negotiating, Auto\_MDIX, LED indicator)

Power requirement:

- Unregulated +10 ~ +30 V<sub>DC</sub>
- Power reverse protection, Over-Voltage brown-out protection
- Power consumption 2.5W

Module specs:

- Dimensions: 119mm x 72mm x 33mm
- Operating temperature: -25 ~ 75 °C
- Storage temperature: -30 ~ 85 °C
- Humidity : 5 ~ 95% RH, non-condensing
- LED Status Indicators(**Table 2**)

*Table 2 LED status indicator*

PWR LED	– Show the power state – Show data state
ERR LED	– Show error state
RUN LED	– Show communication state of PROFIBUS

## 2. Hardware

### 2.1 Block Diagram of GW-7553

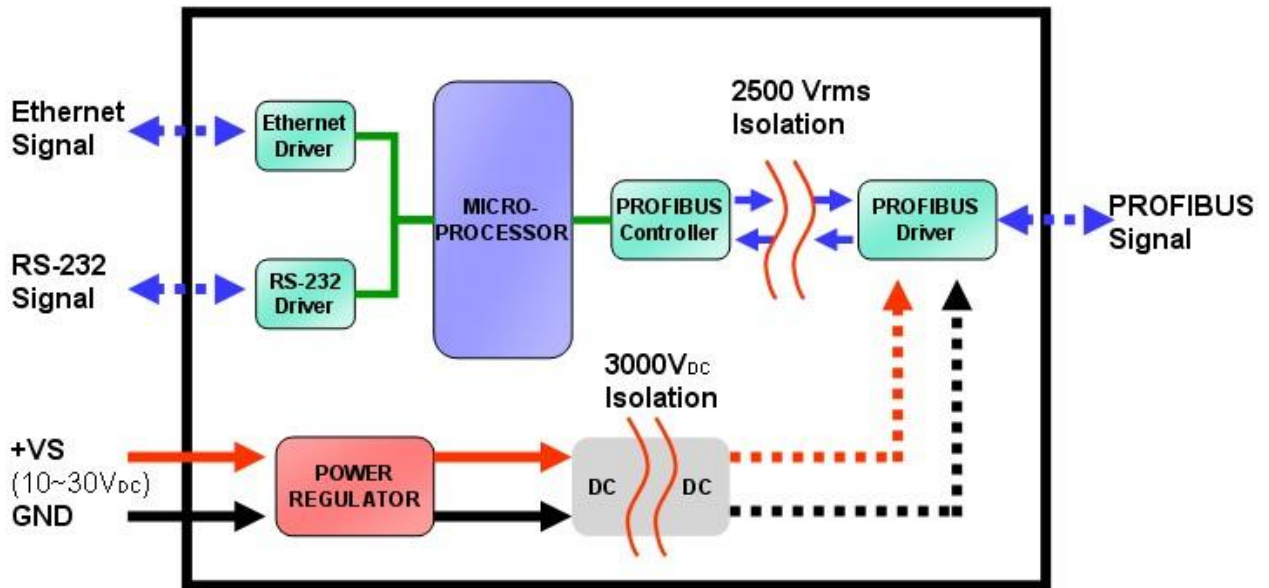

Figure 2 Block diagram of GW-7553

### 2.2 Pin Assignment



Figure 3 Pin assignment of GW-7553

Table 3 9-pin screw terminal block

Pin	Name	Description
1	CTS	Clear to Send of RS-232
2	RTS	Request to Send of RS-232
3	RX	Receive Data of RS-232
4	TX	Transmit Data of RS-232
5	GND	GND of RS-232
6	-	N/A
7	-	N/A
8	+VS	V+ of Power Supply(+10 ~ +30 VDC)
9	GND	GND of Power Supply

Table 4 RJ-45 socket

Pin	Name	Description
1	TX+	TX+ output
2	TX-	TX- output
3	RX+	RX+ input
4	-	N/A
5	-	N/A
6	RX-	RX- input
7	-	N/A
8	-	N/A

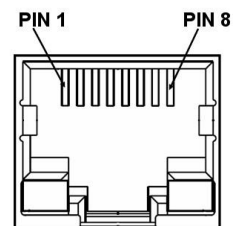
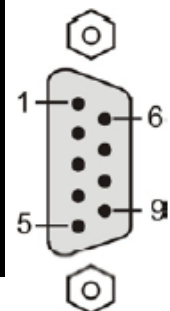

Table 5 PROFIBUS DB9 Female Connector

Pin	Name	Description
1	-	N/A
2	-	N/A
3	B	Non-inverting Bus Line
4	ISODE	Isolated DE output for use in PROFIBUS applications where the state of the isolated drive enable node needs to be monitored.
5	GND	Power supply ground for the first node and the last node





Pin	Name	Description
6	VP	+5V Power Supply for the first node and the last node
7	-	N/A
8	A	Inverting Bus Line
9	-	N/A

## 2.3 Wiring

GW-7553 supports PROFIBUS to Serial or Ethernet communication. It is recommended to use only one communication interface (RS-232 or Ethernet) of the Gateway at the same time. The following section describes the connection interface of GW-7553.

### 2.3.1 RS-232 connection

The RS-232 port of the GW-7553 has got three pins. The wiring of the RS-232 device with the RS-232 port of the GW-7553 is shown in *Figure 4*.

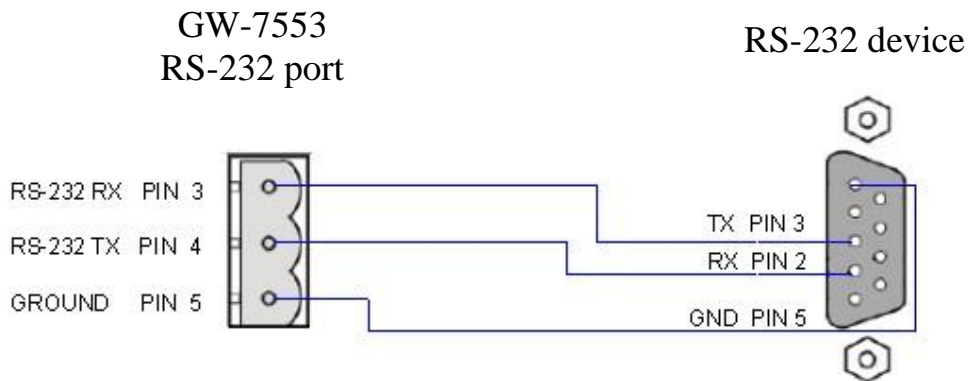

*Figure 4 RS-232 wiring diagram*

### 2.3.2 Ethernet connection

The user can connect GW-7553 with the other device to the same sub network or same Ethernet Switch, as shown in *Figure 5*.

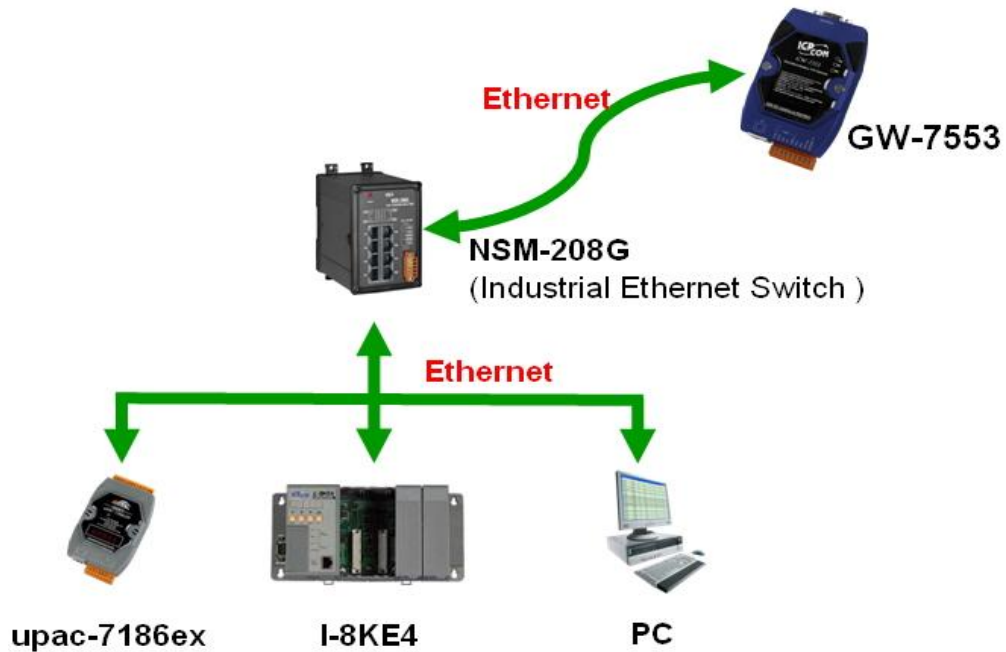

Figure 5 Ethernet connection

### 2.3.3 PROFIBUS Connection

The PROFIBUS interface of the GW-7553 is a DB9 female connector. The connector uses the standard PROFIBUS 9 pin assignment. It is recommended to use a standard PROFIBUS cable and connector (DB9 male). As with every serial bus the rate of safe data transmission in a PROFIBUS network decreases with increasing distance between Master and Slave. **Table 6** shows the transmission rate and range for a cable with the following properties:

1. Impedance :135~165  $\Omega$
2. Capacity : lower than 30 pF/m
3. Loop resistance : lower than 110  $\Omega$ /km
4. Wire diameter : greater than 0.65 mm
5. Core cross-section : greater than 0.34 mm<sup>2</sup>

Table 6 Transmission rate decreasing with increasing transmission distance

Transmission Rate(kbps)	Transmission Distance per Segment (meter)
9.6, 19.2, 45.45,93.75	1200
187.5	1000
500	400
1500	200
3000, 6000, 12000	100

In order to minimize the reflection effect of signal transmission, both ends (first node and last node) of a PROFIBUS segment needs to be equipped with an active terminal resistor as shown in **Figure 6**. A standard PROFIBUS connector is usually already equipped with a terminal resistor. The user therefore only has to switch on the resistor of the devices stationed at the ends of a segment as shown in **Figure 7**.

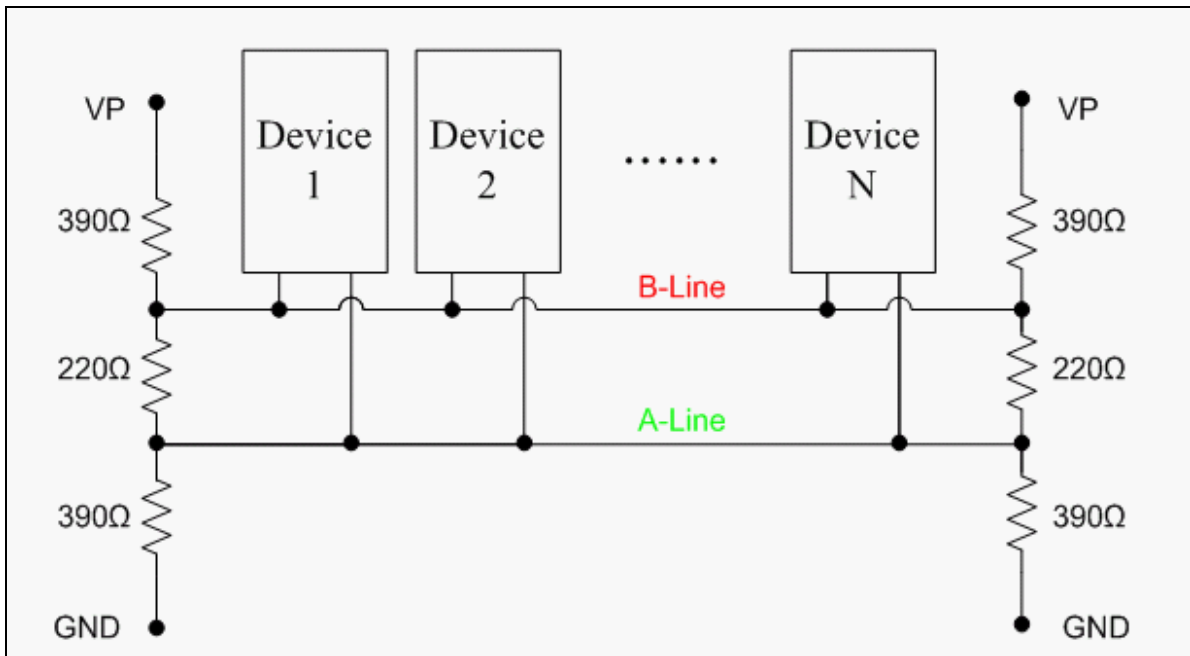

Figure 6 PROFIBUS connection

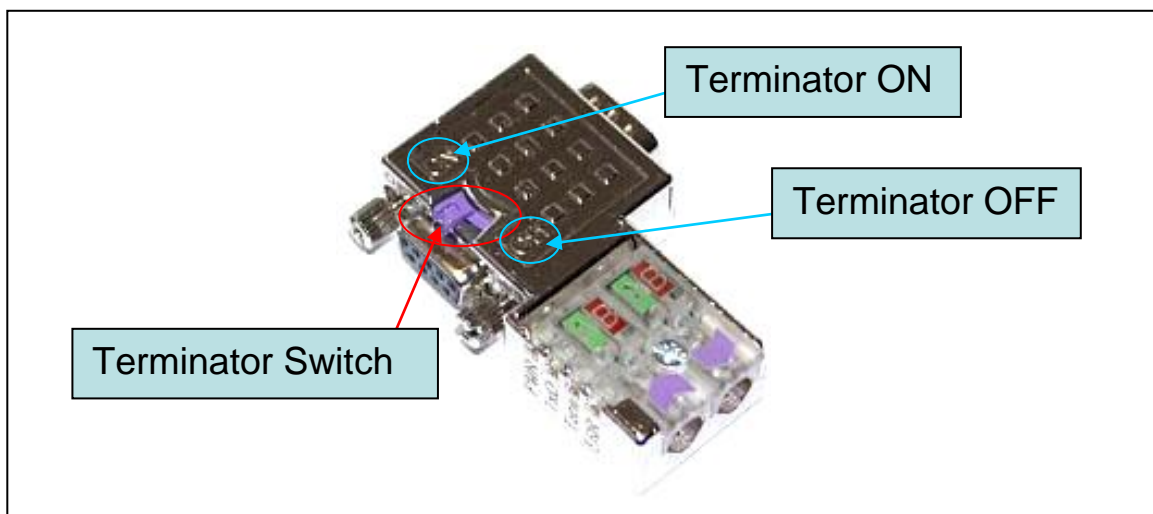

Figure 7 PROFIBUS connector

The number of stations in a PROFIBUS network is restricted to 126. According to the PROFIBUS specification up to 32 stations are allowed per segment. A repeater has to be used to link the bus segments.

## 2.4 Setting the PROFIBUS Address

The station address of GW-7553 can be set by using either the DIP switch or by writing it directly to the EEPROM. The DIP switch covers a range from 0 to 255. The valid address range of a PROFIBUS station spans from 0 to 126. **Table 7** shows three examples of setting the station address by using the DIP switch. The DIP switches are accessed by opening the modules housing (**Figure 8**). **Table 8** explains which address will be used by the module after power on, if the DIP switch address setting differs from the address stored in the EEPROM.

*Table 7 DIP switch setting example*

Station address	DIP switch (SW1)							
	1	2	3	4	5	6	7	8
1	1	0	0	0	0	0	0	0
10	0	1	0	1	0	0	0	0
126	0	1	1	1	1	1	1	0

*Note: 1=>ON, 0=>OFF*

*Table 8 The Address setting of the GW-7553*

DIP switch Setting	Description
0~125	<ol style="list-style-type: none"> <li>1. The address setting of the EEPROM is ignored.</li> <li>2. The address can not be set by the PROFIBUS configuration tool.</li> </ol>
126-254	<ol style="list-style-type: none"> <li>1. The address setting of the DIP switch is ignored.</li> <li>2. If the address in the EEPROM is 126, the PROFIBUS configuration tool can set a new address and save it to the EEPROM.</li> </ol>
255	<ol style="list-style-type: none"> <li>1. Slave address in the EEPROM is set to 126.</li> </ol>

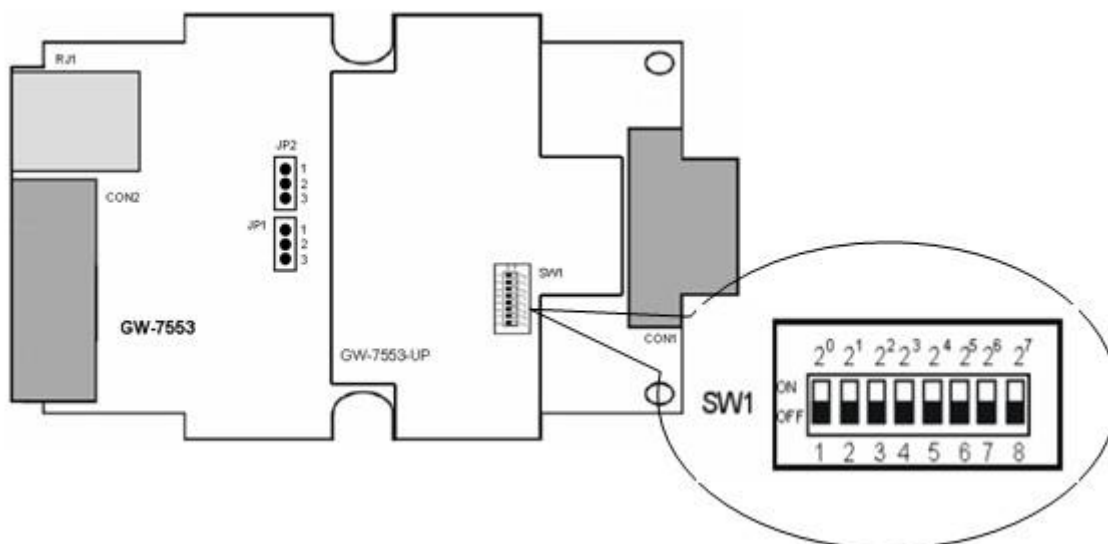

Figure 8 DIP switch

Each Slave must have a unique valid address (1 to 125) in order to be able to communicate with the Master. To change the address by using the configuration tool it is necessary to first set the address stored in the EEPROM to 126. This is done by setting the DIP switch to 255 in the power off state. Switching the module on is forcing the module to change its address in the EEPROM to 126. In the next step switch the module off and change the DIP switch setting to any value from 126 to 254. This step is necessary in order to prevent the module to change its address in the EEPROM to 126 every time it is powered on. The configuration tool can now assign the Slave a new address.

## 2.5 LED status indicator

The GW-7553 provides three LEDs to indicate the statuses of the GW-7553 module. The position of LEDs and descriptions are shown in **Table 9** and **Figure 9**.

Table 9 LED status description

LED Name	Status	Description
PWR	flash	When the GW-7553 acts as a Modbus Slave device and receiving query message form Modbus Master device, PWR led will flash.
	on	Power supply is ok. The firmware has loaded.

LED Name	Status	Description
	off	Power supply has failed.
ERR	flash	When the GW-7553 connects with the utility tool, it will flash fast (flash once about 55ms). When the GW-7553 has diagnostic message, it will flash slowly (flash once about 220ms).
	on	– Connection error between PROFIBUS Master and Slave or – PROFIBUS system has not been configured correctly.
	off	Normal operation PROFIBUS system has been configured correctly
RUN	on	Data exchange mode Normal operation.
	off	GW-7553 module is not in a data exchange mode.



Figure 9 LED position

## 2.6 Normal/Setting DIP switch

There is a DIP switch on the back of the GW-7553 module, as shown in *Figure 10*. The DIP switch is used to set the GW-7553 module works in operation mode or setting mode. In the normal situation, it needs to set the DIP switch to the “Normal” position. In this case, the GW-7553 module can communicate with Modbus devices. When the user sets the DIP switch to the “Setting” position, the GW-7553 module can communicate with the utility to set the safe value and network configuration.

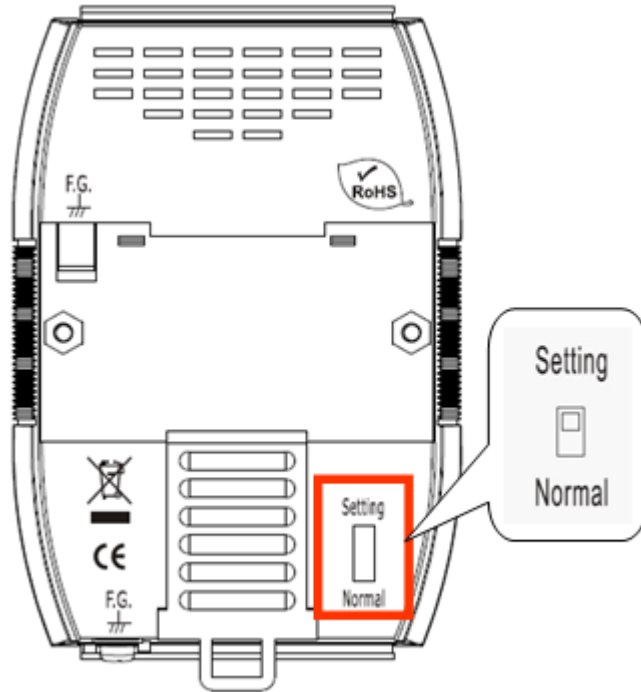

*Figure 10* DIP switch of the GW-7553

PS:

There are two kinds of methods to enable the setting mode of the GW-7553. The user can change the position of the DIP switch or set the control bit (please refer section 4.6.2 Output data area and communication command) to enable the setting mode of the GW-7553, as shown in *Table 10* .

*Table 10* Mode of GW-7553

Mode	SM(control bit)=0	SM(control bit)=1
DIP switch=Normal	operation mode	setting mode
DIP switch =Setting	setting mode	setting mode

### 3. Communication protocol transfer theorem

#### 3.1 PROFIBUS data exchange

The GW-7553 is a PROFIBUS DP Slave device. The GW-7553 is first parameterized then configured and finally it goes into the data exchange mode (*Figure 11*).

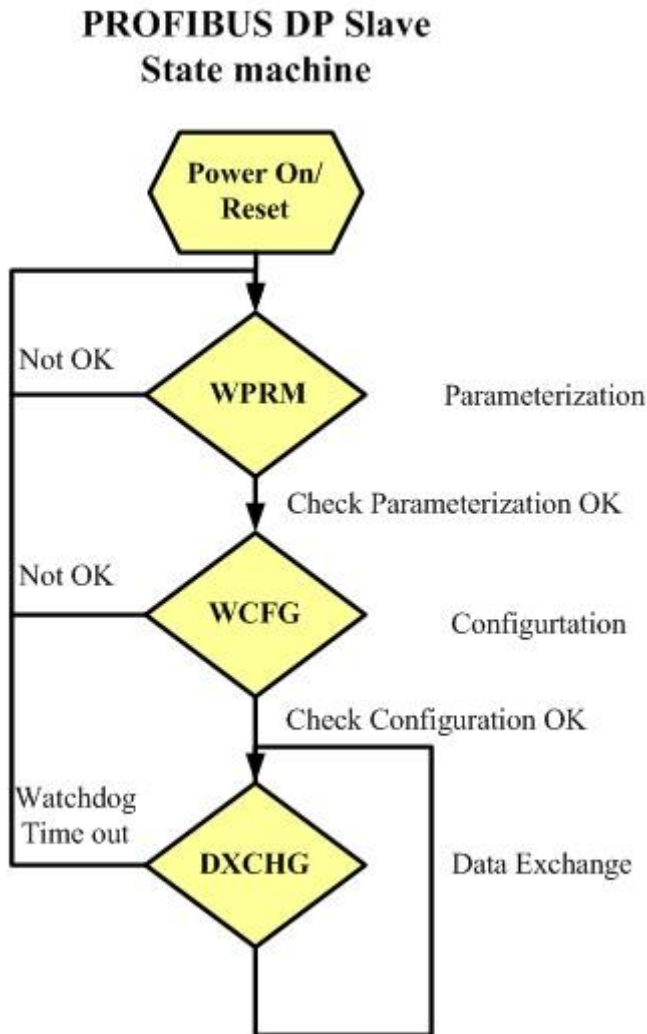

*Figure 11 State machine of PROFIBUS DP Slave device*

The GW-7553 exchanges data cyclically between internal DI、DO、AI、AO data and PROFIBUS Master device in data exchange mode, as shown in *Figure 12*.



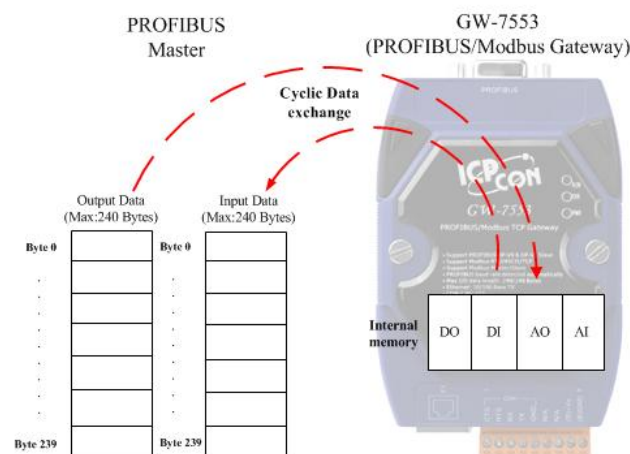

Figure 12 Data exchange between PROFIBUS Master device and GW-7553

The GW-7553 downloads the parameter and configuration from PROFIBUS Master device to be the module parameters. The GW-7553 and PROFIBUS Master device have different data type and data address, the GW-7553 can transfer different data format to PROFIBUS Master device through module parameters. When the GW-7553 acts as a Modbus Master device, it will send DI、AI data to input data area of PROFIBUS Master device and it will save data that receives from PROFIBUS Master device to internal DO、AO memory space, as shown in **Figure 13**、**Figure 14**.

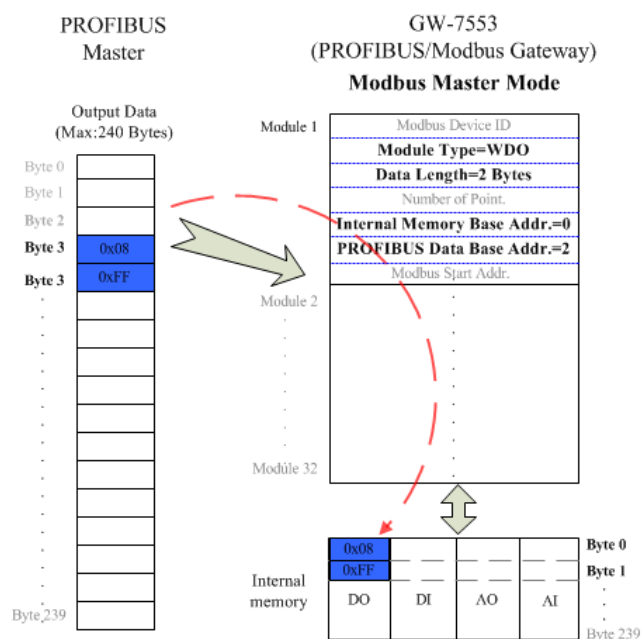

Figure 13 The output data of PROFIBUS Master device send to the GW-7553

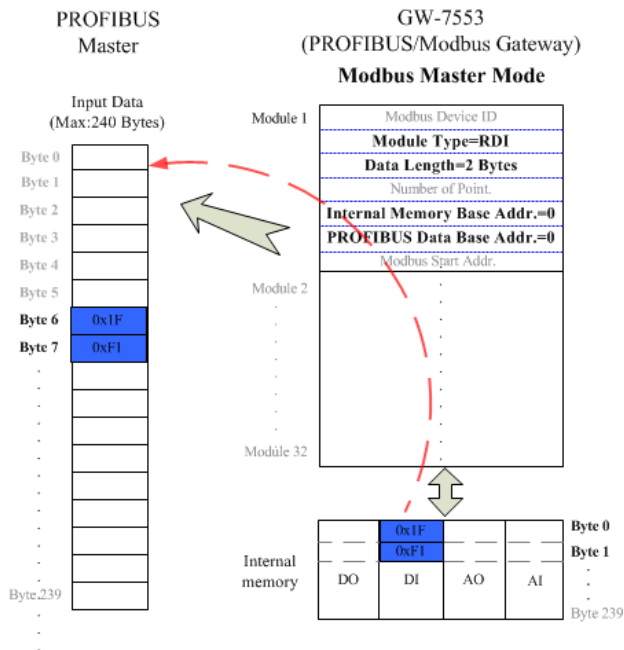

Figure 14 The input data of PROFIBUS Master device receive from the GW-7553

When the GW-7553 acts as a Modbus Slave device, it will send DO、AO data to input data area of PROFIBUS Master device and it will save data that receives from PROFIBUS Master device to internal DI、AI memory space, as shown in **Figure 15**、**Figure 16**.

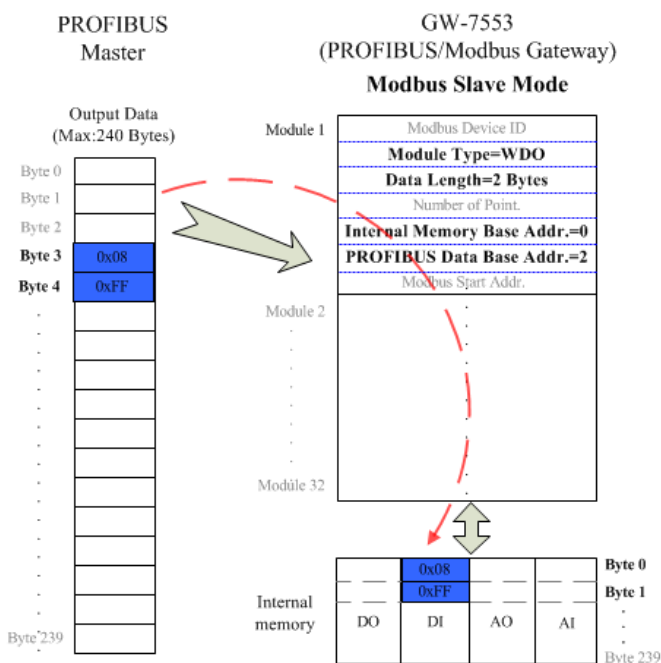

Figure 15 The output data of PROFIBUS Master device send to the GW-7553

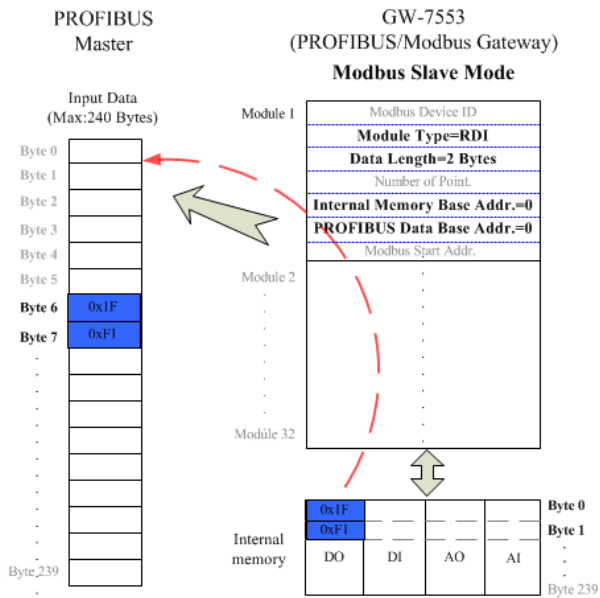

Figure 16 The input data of PROFIBUS Master device receive from the GW-7553

### 3.2 Modbus data exchange

Modbus protocol belongs to Master-Slave communication and it uses query and response message to arrive at data exchange and device control, as shown in **Figure 17** Data exchange between the Modbus devices and the GW-7553.

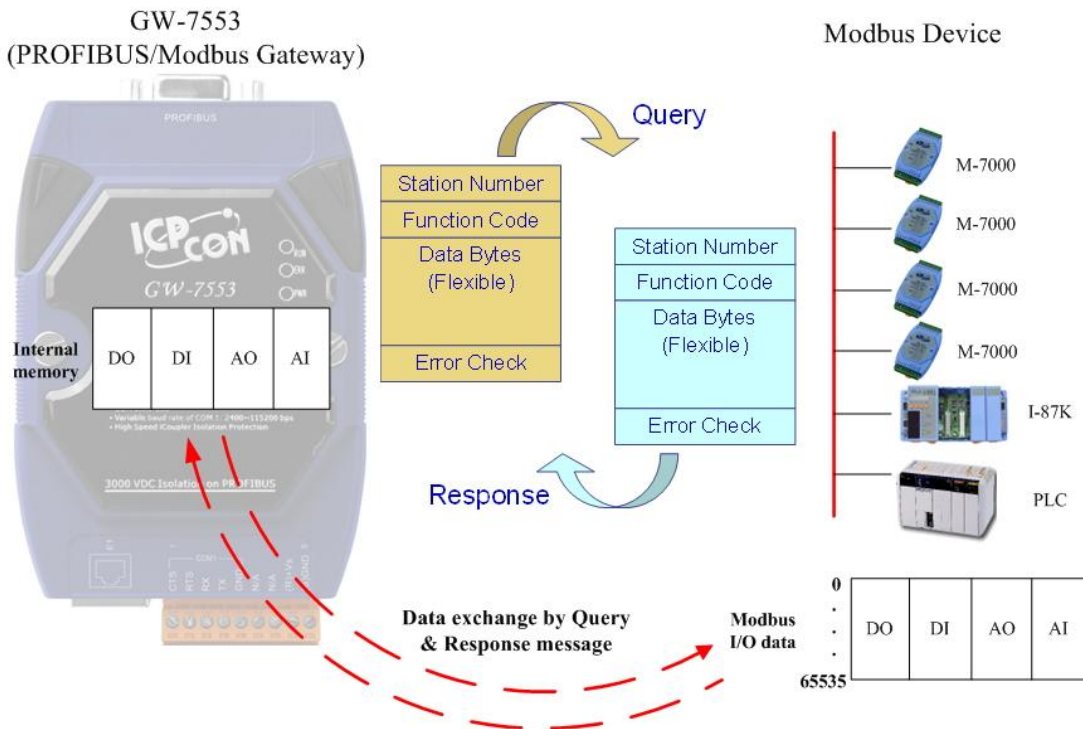

Figure 17 Data exchange between the Modbus devices and the GW-7553

When the GW-7553 acts as a Modbus Master device, it can get query message

through module parameter and DO、AO data and send query message to Modbus Slave device. It can also receive response message form Modbus Slave device and then saving to internal DI、AI memory space, as shown in **Figure 18**、**Figure 19**.

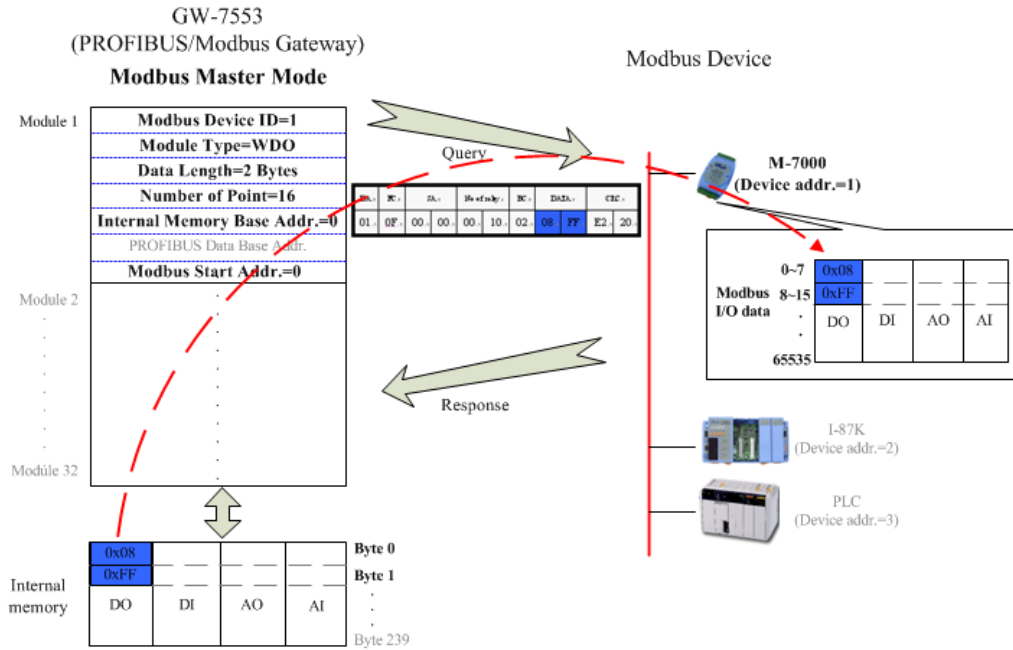

Figure 18 GW-7553 output data to Modbus Slave devices

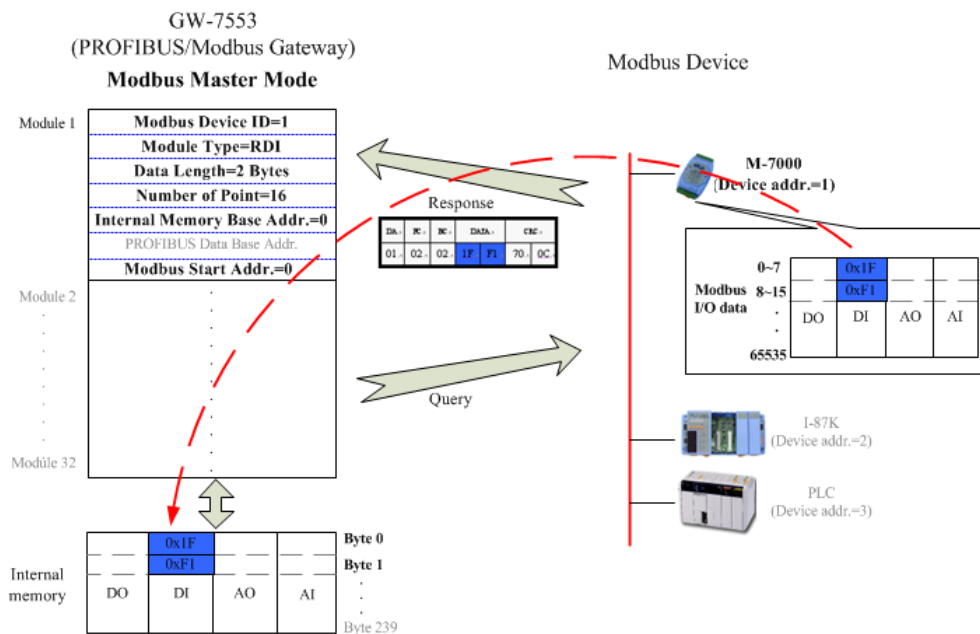

Figure 19 GW-7553 receive data from Modbus Slave devices

When the GW-7553 acts as a Modbus Slave device, it can receive query message

from Modbus Master device and then saving to internal DO、AO memory space. It can also send response message to Modbus Master device through internal DI、AI data, as shown in *Figure 20*、*Figure 21*.

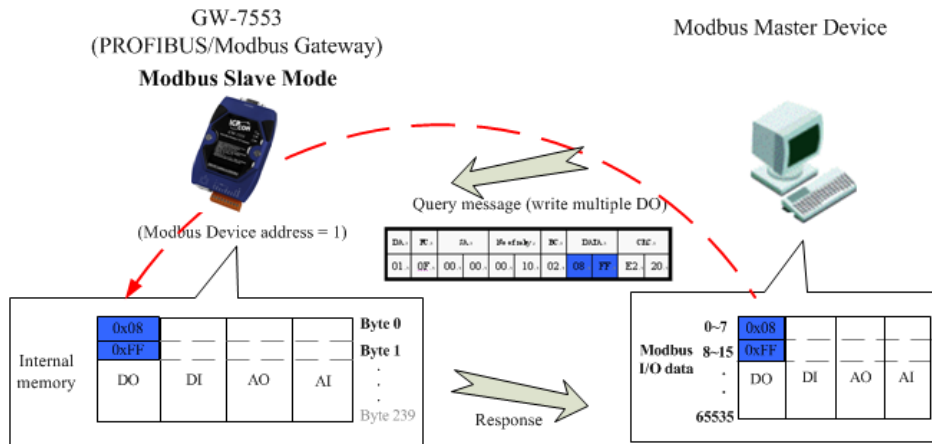

Figure 20 The GW-7553 receive data from Modbus Master device

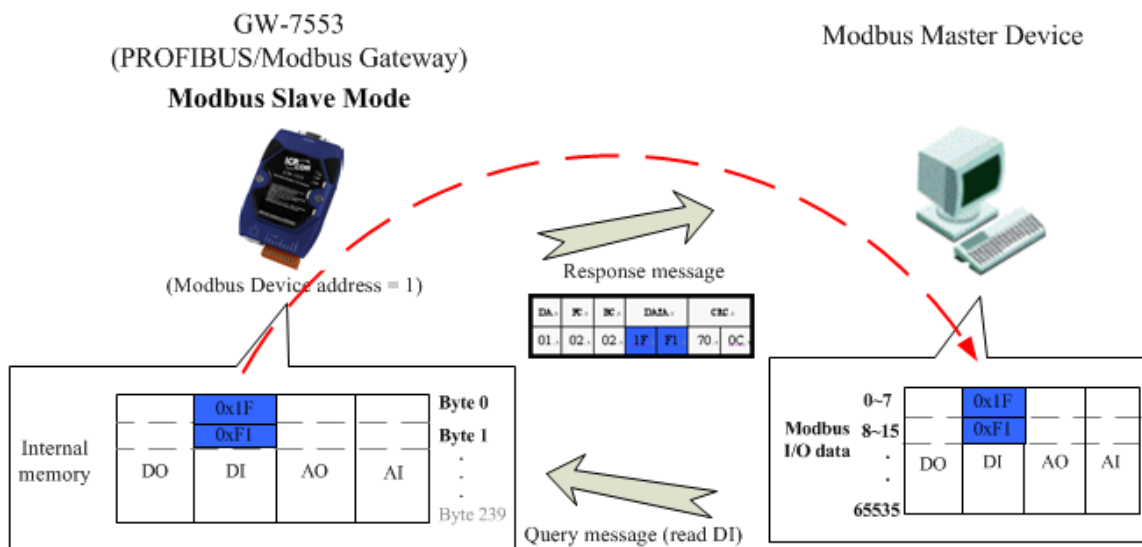
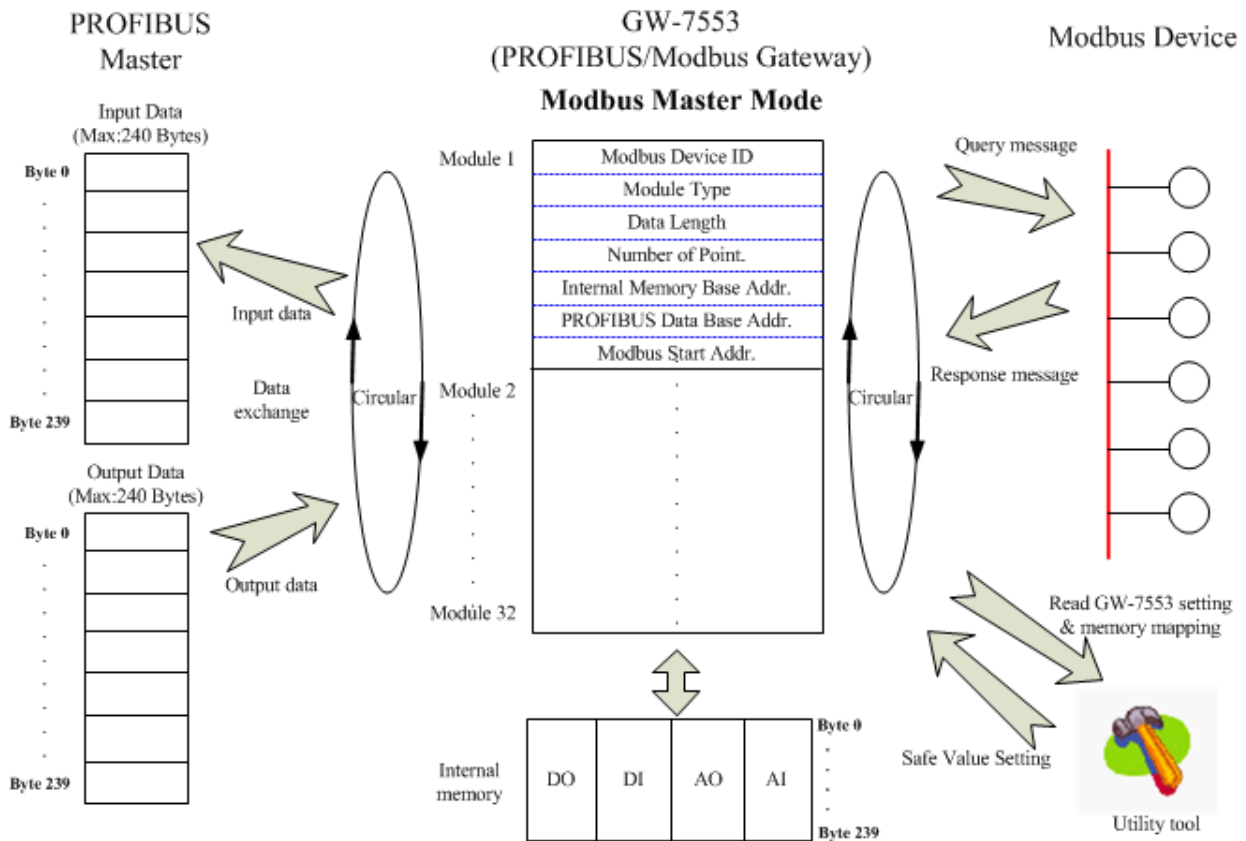

Figure 21 The GW-7553 output data to Modbus Master device

### 3.3 Communication protocol transfer

In section 3.1 and 3.2, we can understand that data exchange is through DI、DO、AI、AO memory space of the GW-7553 between PROFIBUS Master、Modbus and the GW-7553. When the GW-7553 acts as a Modbus Master device, the data exchange runs continuously between PROFIBUS Master、Modbus and the GW-7553, as shown in **Figure 22**、**Figure 23**.



*Figure 22 GW-7553 (master mode) communication protocol transfers*

### GW-7553 data exchange (master mode)

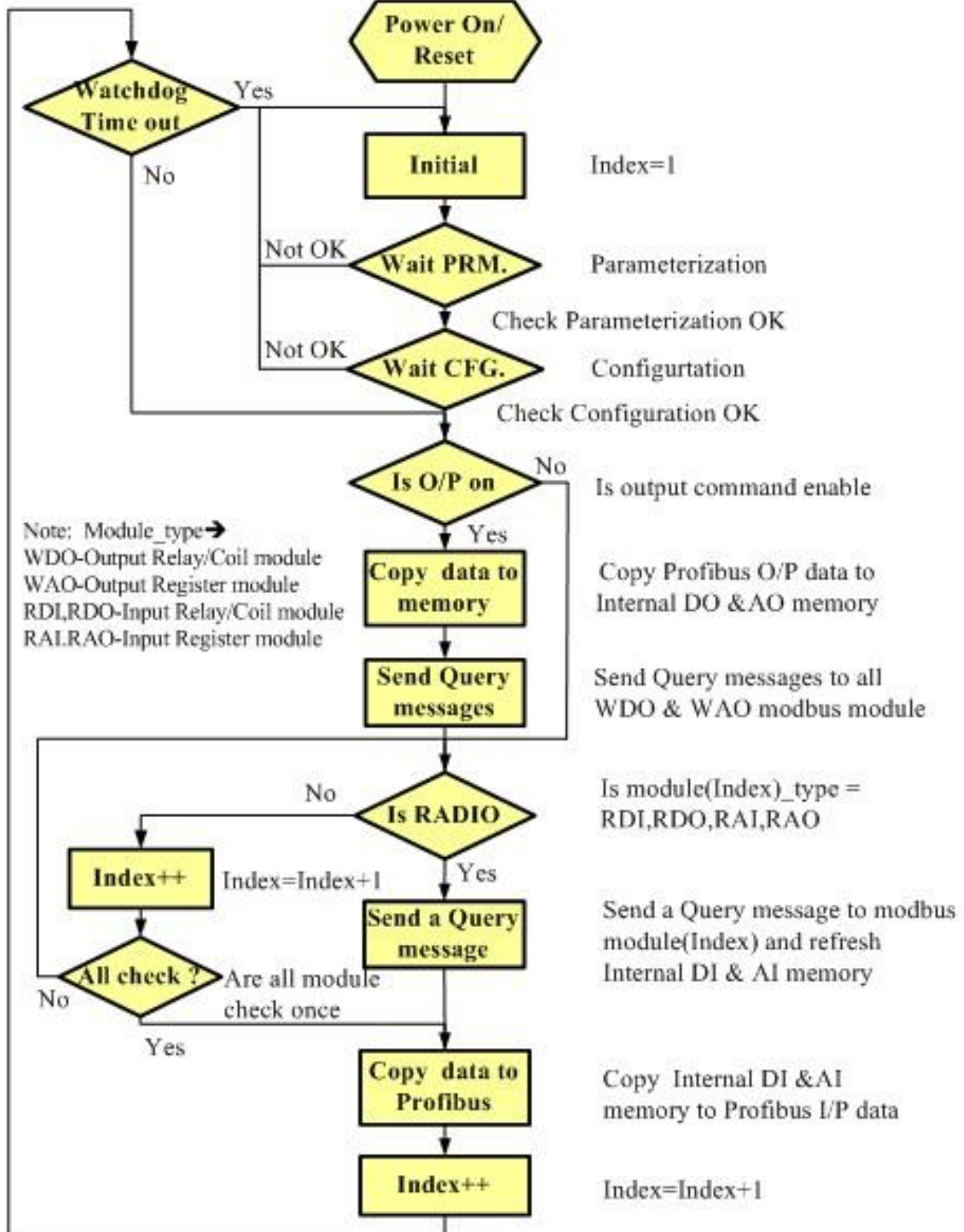

Figure 23 GW-7553 (master mode) flowchart

When the GW-7553 acts as a Modbus Slave device, the data exchange runs continuously between PROFIBUS Master and the GW-7553 and the data exchange runs between Modbus Master device and the GW-7553, when GW-7553 receive query message from Modbus Master device, as shown in *Figure 24* , *Figure 25*.

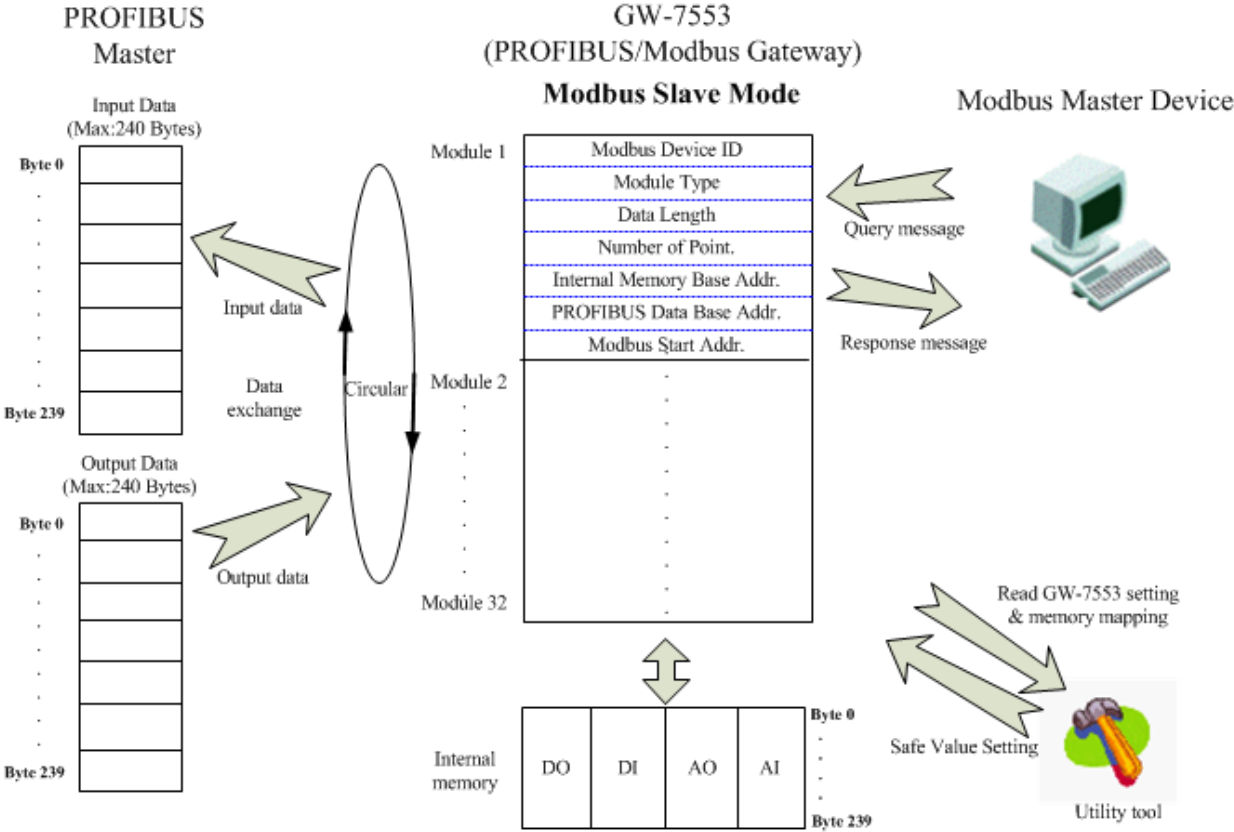

Figure 24 GW-7553 (slave mode) communication protocol transfer



### GW-7553 data exchange (slave mode)

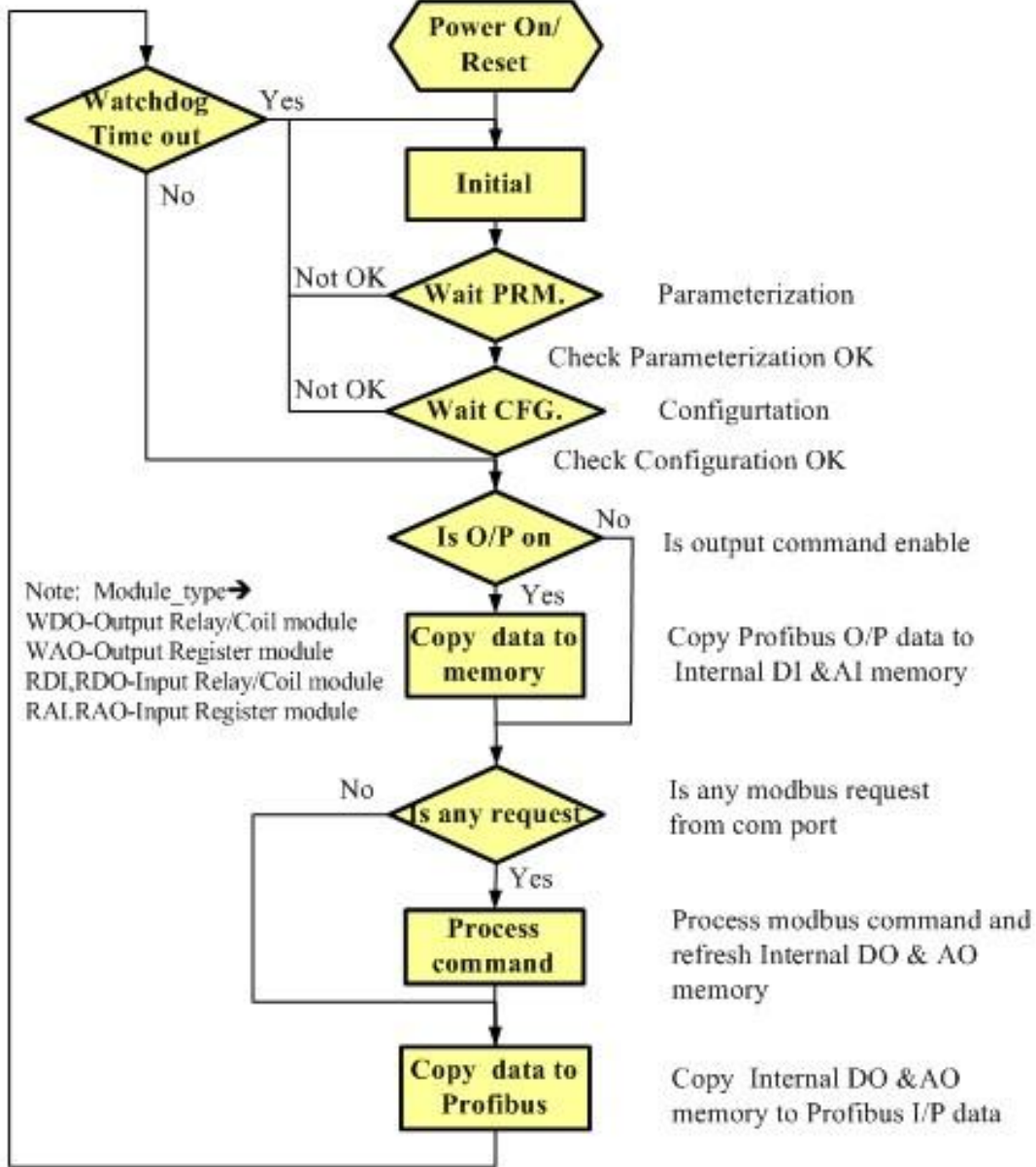

Figure 25 GW-7553 (slave mode) flowchart

### 3.4 PROFIBUS DP-V1 Acyclic Service

DP-V1 is the extension of DP-V0, it extend the original cyclic data exchange to acyclic one. Traditional data-exchange exploits default SAP for cyclic data-exchange. In DP-V1, Additional SAPs(49, 50, 51) for acyclic service, The SAP 49 is Resource Manager for manage each class 2 connection; The SAPs 50 and 51 are Read/Write/Alarm\_Ack access point for class 1 connection.

DPV1 extension consists of 2 main parts : 1. MSAC\_C1 2. MSAC\_C2. For details, as shown in *Table 11*.

*Table 11 Service for DPV1 acyclic communication*

	service
MSAC_C1	Class 1 master reads a data block from the slave ( <b>Read</b> )
	Class 1 master writes a data block to the slave ( <b>Write</b> )
	An alarm is transmitted from the slave to the master, which explicitly acknowledge receipt ( <b>Alarm</b> · <b>Alarm_Ack</b> )
MSAC_C2	Setup of a connection for acyclic communication between the calss 2 master and the slave ( <b>Initiate</b> )
	Class 2 master reads a data block from the slave ( <b>Read</b> )
	Class 2 master writes a data block to the slave ( <b>Write</b> )
	Class 2 master can write application-specific data acyclically to the slave and, if required, read data from the slave in the same cycle ( <b>Data Transport</b> )
	Termination of a connection for acyclic communication between the calss 2 master and the slave ( <b>Abort</b> )

DP-V1 slave provide a unique acyclic service entry SAP 49, this SAP called Resource Manager. Resource Manager play the role of coordinator, it coordinate multiple remote connection at one time. Before acyclic data-exchange, class 2 master send an initiate request to SAP 49, then resource manager search for an available SAP(48~0) to response these information to Class 2 Master. After Class 2 Master receives initiate response, it applies the new SAP to request information you want. In contrast to C1 Master, C2-Master supports Data-Transport service for read & write at one cycle. If DP-V1 services were no more need, Class 2 Master sent the Abort request to terminate the connection. During the connection, DP-Slave start watchdog timer to monitor the C2 DP-V1 telegram (C2-Init, C2-Abort, C2-Write, C2-Read, C2-DataTransport, C2-IDLE). If watchdog timer didn't clear by C2-IDLE, DP-slave will terminate this connection automatically.

The Information in DP-V1 is addressing by Slot and Index. The slot(0~255) addresses the module and the index(0~255) addresses the data blocks assigned to

a module. Each data block can be up to 244 bytes. Length is used to indicate the read/write length. If the information addressing use non-existent slot, index or length, the corresponding error code will be signaled (see **Table 12**、**Figure 26** Error code/Error class), the reply is sent to the master.

*Table 12 Error code/Error class*

Error_Class	Meaning	Error_Code
10	application	0 = read error 1 = write error 2 = module failure 3 to 7 = reserved 8 = version conflict 9 = feature not supported 10 to 15 = user specific
11	access	0 = invalid index 1 = write length error 2 = invalid slot 3 = type conflict 4 = invalid area 5 = state conflict 6 = access denied 7 = invalid range 8 = invalid parameter 9 = invalid type 10 to 15 = user specific
12	resource	0 = read constrain conflict 1 = write constrain conflict 2 = resource busy 3 = resource unavailable 4 to 7 = reserved 8 to 15 = user specific

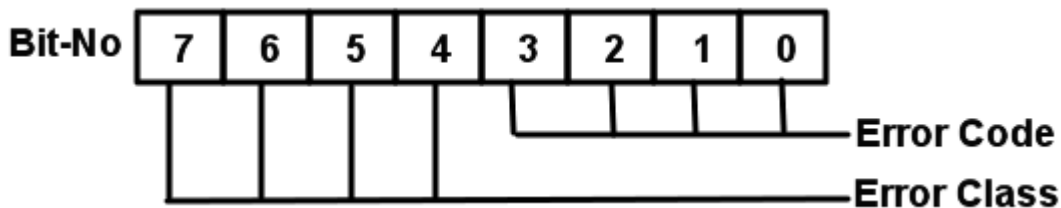

*Figure 26 Error code/Error class*

DP-V1 services supported by GW-7553 are Read 、 Write and Data Transport service, Alarm\_Ack didn't supported. List shown below is the Slot-Index mapping table.

Table 13 Slot-Index mapping table

Slot	Modbus Type	Index	Length
1	N/A	0	1
2~32	RDI	NO. of relay/Coil	1
	RDO		
	WDO		
	RAI	NO. of Words	2
	RAO		
	WAO		
33~255	N/A	N/A	N/A

**Slot 1** is used for the system setting module. Because the user must add “System setting module” at the first module before the other modules, else the GW-7553 will send the diagnostic messages to PROFIBUS Master and the system will be abnormal.

**Slot 2~32** is used for Modbus modules. Index mapped input/output channel from corresponding module. If a digital module(DI/DO module), one index is only one bit. If a analog module(AI/AO module), one index is one word.

**Slot 33~255** is not supported by GW-7553. Because the maximum number of I/O modules is 32.

Note :

The data block fixed by DPV1 write acyclic service will be overwritten by DPV0 cyclic service. We provide an option in “slot 1 、 index 0 、 length 1” to change the priority of DPV1 write acyclic service . The Default value is 0. To achieve the higher priority of DPV1 write acyclic service , the value has to be set to “1”.

Example 1:

If user setup 3 modules in GW-7553, system setting module 、 2 bytes digital output module(DO) and 4 words analog input module(AI).

In this case, the range of slot 、 index and length of each modules is shown in below.

system setting module : slot -> 1, index -> 0 , length -> 1

2 bytes digital output module : slot -> 2, index -> 0~15 , length -> 1

4 words analog input module : slot -> 3, index -> 0~3 , length -> 2

## 4. Communication

### 4.1 Field of application

A master station can be a PLC, PC or any other smart device. The system can be a mono-master system (*Figure 27*) or a multi-master system (*Figure 28*). The GW-7553 enables the integration of the Modbus devices into a PROFIBUS DP network.

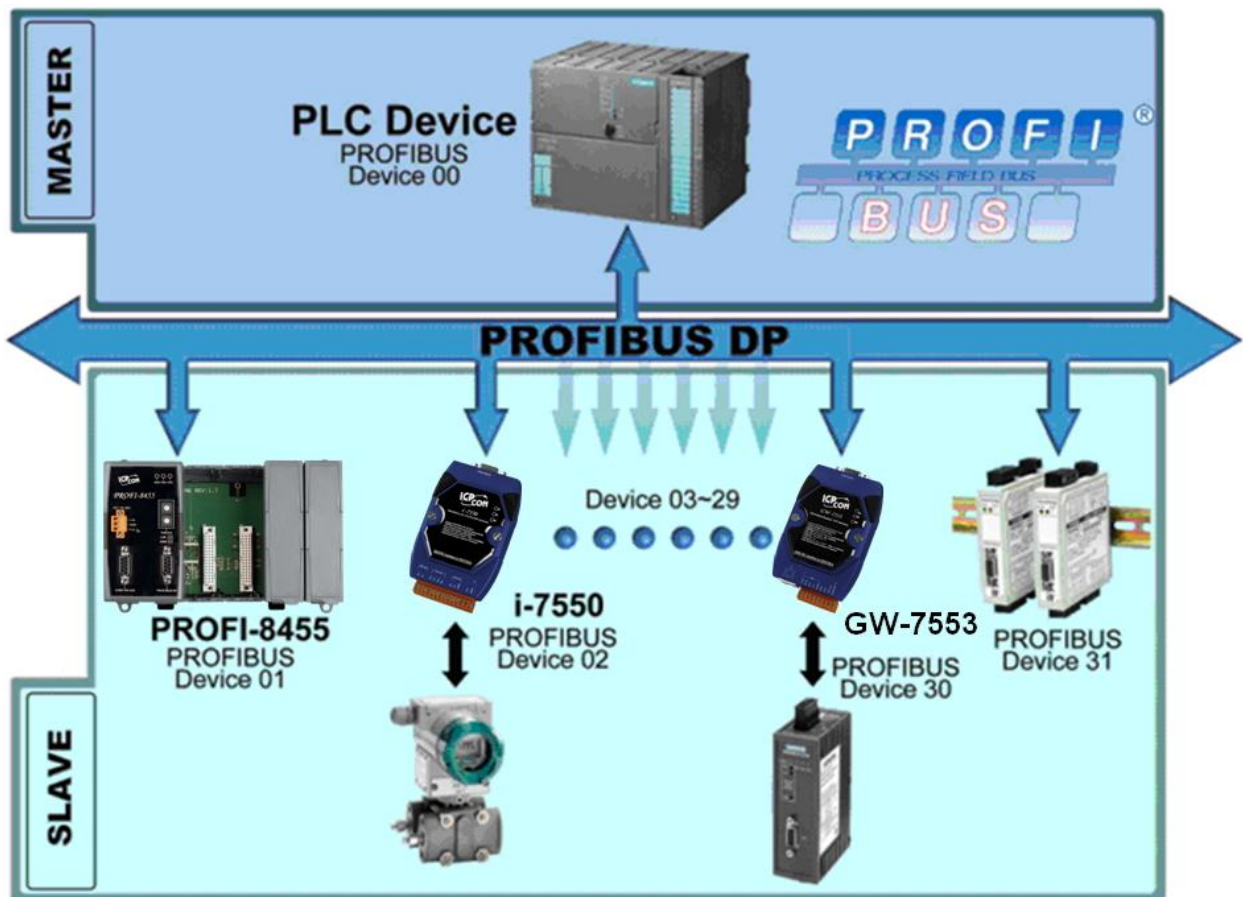

Figure 27 Mono-master system

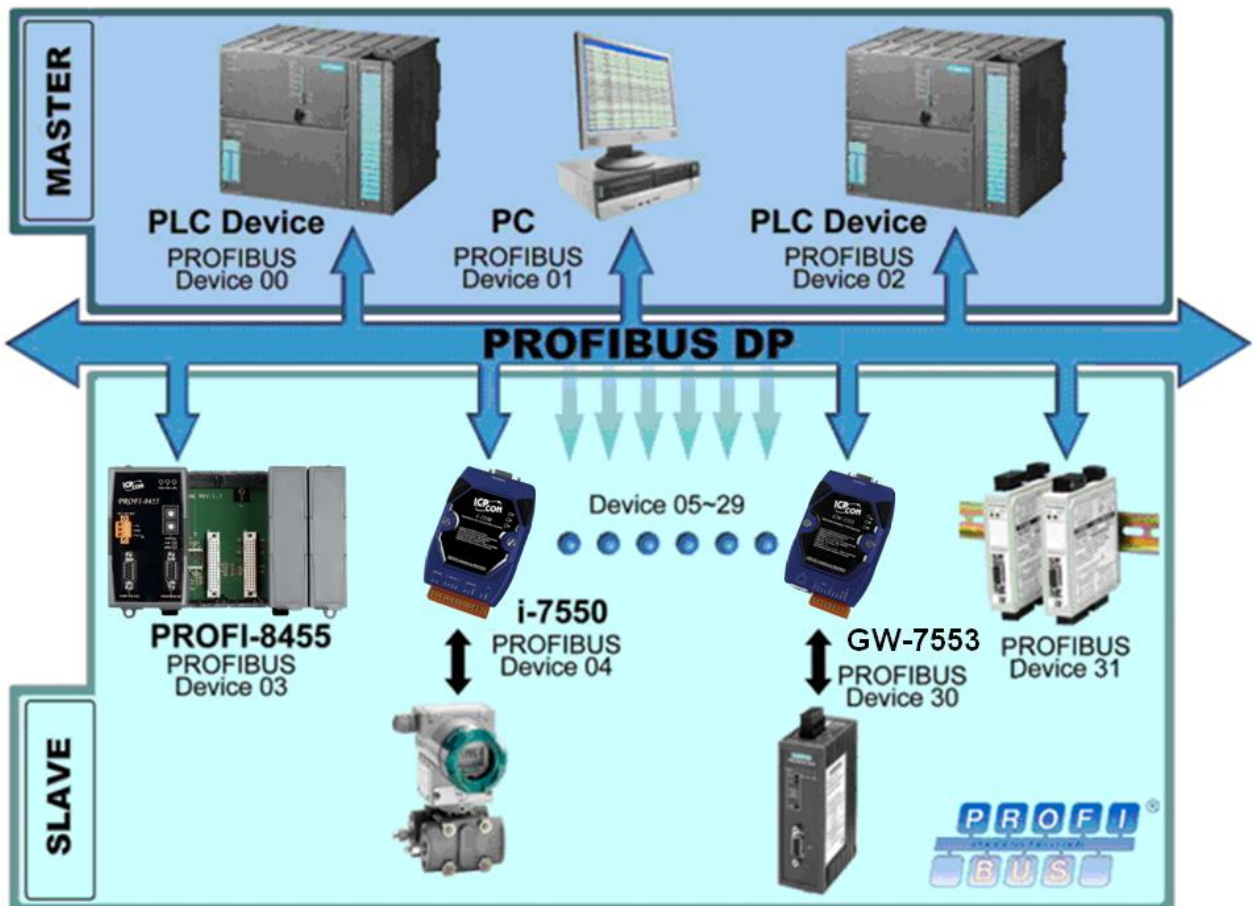

Figure 28 Multi-master system

## 4.2 GSD file

The characteristic (ex: baud rate, message length, number of input / output data....) of each PROFIBUS DP device is described in the GSD file. The GSD file of the GW-7553 is in the ICP DAS companion CD-ROM (PATH--> CD: \profibus\gateway\gw-7553\gsd\). The user can copy GSD file ( IPDS0C0D.gsd ) and the Bitmap file ( ICP\_7553.bmp,GW\_7553.bmp ) to the PROFIBUS configuration tool.

### 4.2.1 The example of how to load GSD file

In the following examples the CIF50-PB PROFIBUS Master card from Hilscher is used. The configuration and communication is done by the program “SyCon” provided by Hilscher.

Step 1: Copy the GSD file (IPDS0C0D.gsd) and the Bitmap file (ICP\_7553.bmp,GW\_7553.bmp) from CD of the GW-7553 module into the PROFIBUS configuration tool.

**File->CopyGSD**

(Directory: --> CD: \profibus\gateway\gw-7553\gsd)

Step 2: Click “insert slave” button in the PROFIBUS configuration tool.

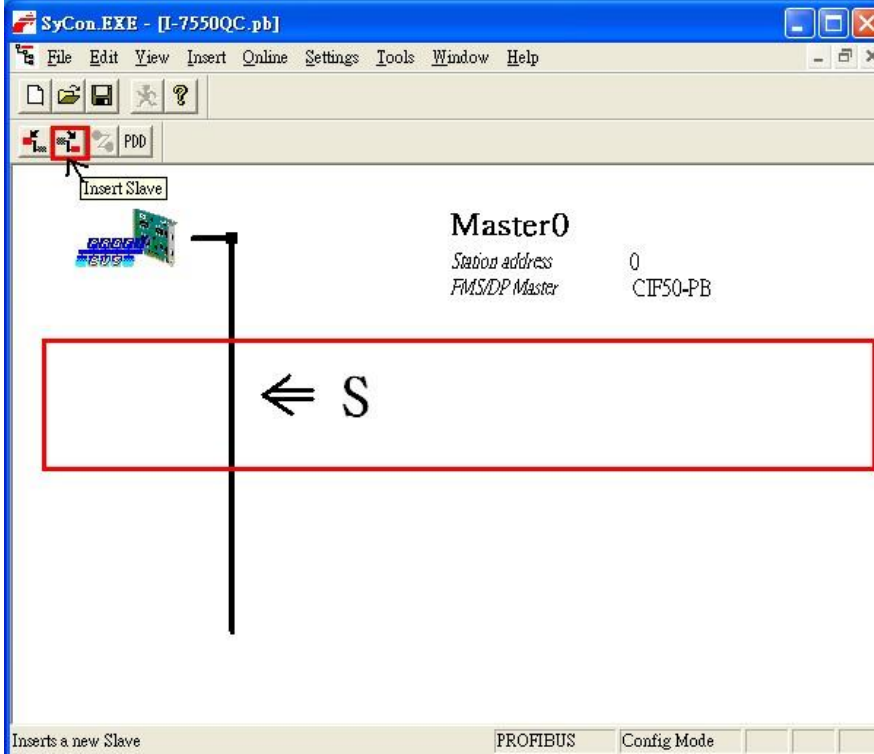

Figure 29 Insert PROFIBUS Slave device

Step 3: Select GW-7553 and click “Add” button to assign the GW-7553.

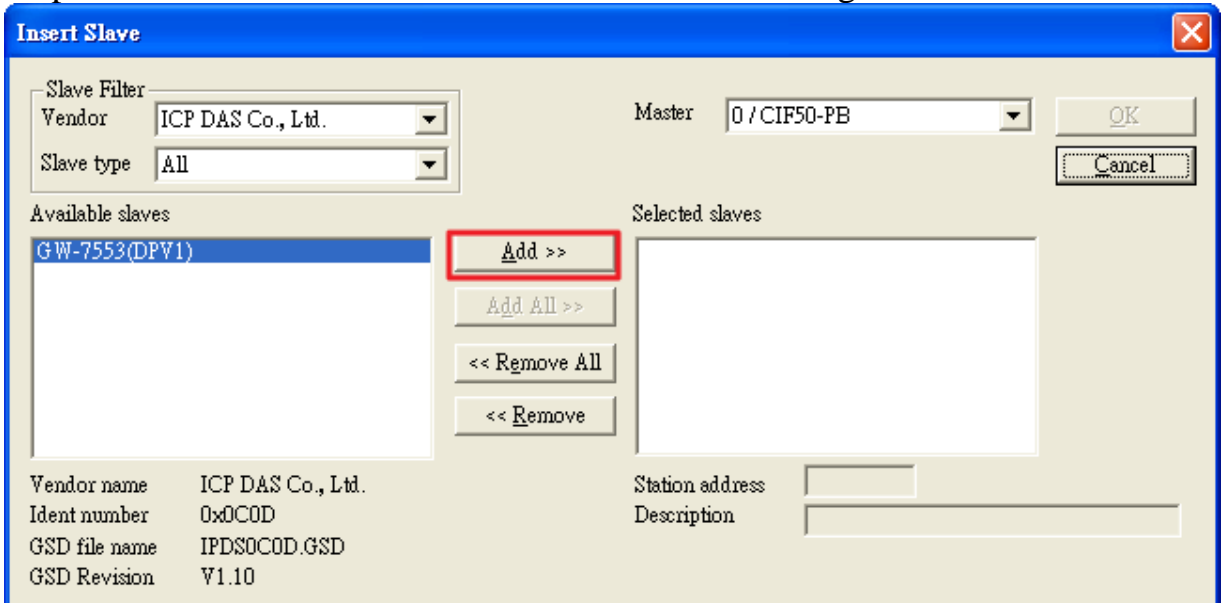

Figure 30 Assign the GW-7553



Step 4: Set the address of the GW-7553 and click “OK” button.

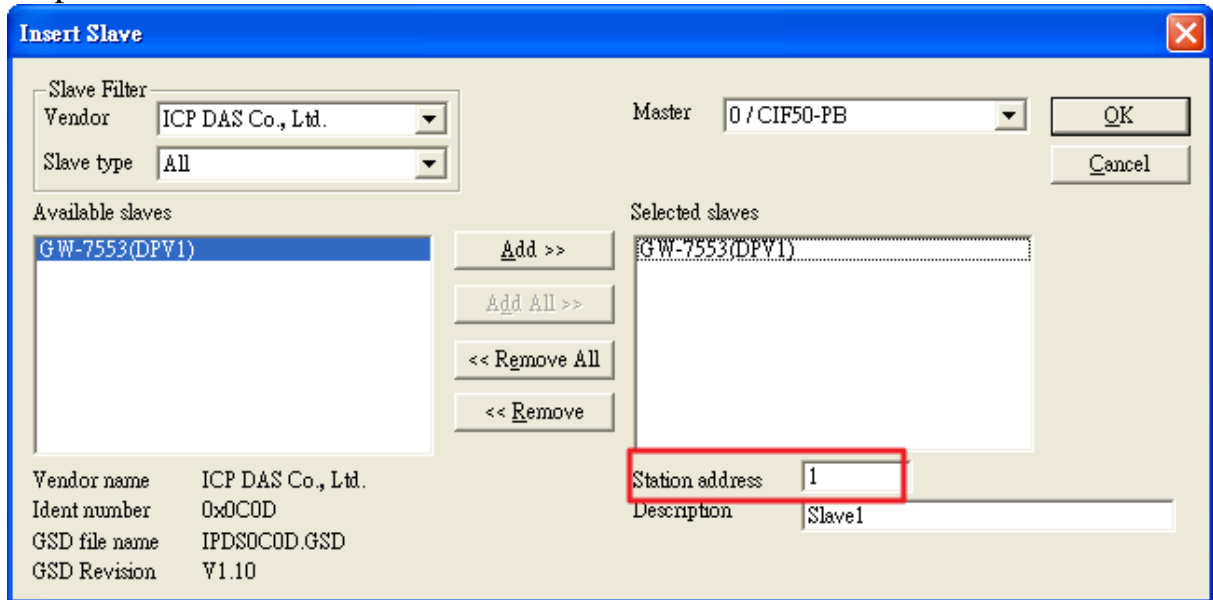

Figure 31 Set the address of the GW-7553

Step 5: The GW-7553 icon is shown in the window. It adds the GW-7553 successfully in the software.

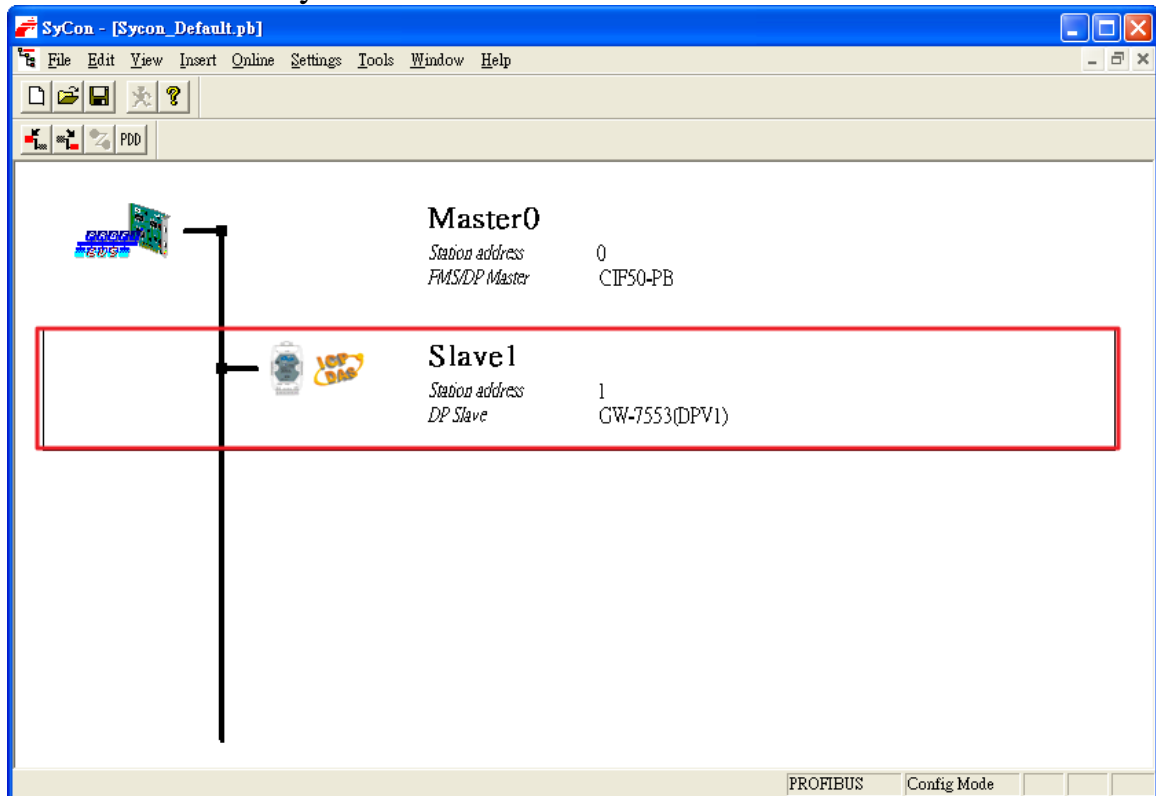

Figure 32 Finish adding the GW-7553

### 4.3 The Configuration of the common parameters

GW-7553 has twelve common parameters. The user can configure the common parameters to set the communication mode and data format by the PROFIBUS configuration tool. The common parameters are described below.

- COM Port baud rate : 2400/4800/9600/19200/38400/57600/115200
- COM Port parity : None/Even/Odd
- COM Port data length : 7/8 data bit
- COM Port stop bit : 1/2 stop bit
- Modbus Type : Master/Slave
- Modbus Format : RTU/ASCII/TCP
- I/O Safe Mode : Retain last value/Switch safe value
- Byte Order : Little-Endian/Big-Endian
- Output Data Mode : Manual/Auto
- Modbus Device ID(S) : 1~247
- Polling Modbus Device Interval(ms) (M) : 1~65535ms
- Query Message Timeout Value(ms)(M) : 1~65535ms
- TCP\_Connect\_Num(T)(M) : 1~8

PS :

- a. When stop bit of COM Port is 2, data bit of COM Port must be 7 or else stop bit of COM Port will be set to 1.
- b. I/O Safe Mode

**When GW-7553 acts as a Modbus Master (Modbus Type=Master):**

- i. *Data exchange between PROFIBUS Master and GW-7553 is interrupted*  
“I/O Safe Mode” will be activated when the data exchange between PROFIBUS Master and GW-7553 is interrupted (e.g. no physical connection, PROFIBUS Master leaves the data exchange mode, etc.).
  - I/O safe mode = “Switch Safe Value”  
The GW-7553 will set internal DIO and AIO data to safe value and send the safe values to the Modbus Slave device.
  - I/O safe mode = “Retain Last Value”  
Internal DIO and AIO data retain last value
- ii. *Connection between Modbus Slave and the GW-7553 is interrupted*
  - I/O safe mode = “Switch Safe Value”  
The GW-7553 will set the internal DI and AI data to safe value and send safe values to PROFIBUS Master device.
  - I/O safe mode = “Retain Last Value”

Internal DIO and AIO data retain last value

**When GW-7553 acts as a Modbus Slave (Modbus Type=Slave):**

- i. Data exchange between PROFIBUS Master and GW-7553 is interrupted*  
“I/O Safe Mode” will be activated when the data exchange between PROFIBUS Master and GW-7553 is interrupted.
  - I/O safe mode = “Switch Safe Value”  
The GW-7553 will set internal DIO and AIO data to safe value.
  - I/O safe mode = “Retain Last Value”  
Internal DIO and AIO data retain last value
  
- ii. Connection between Modbus Master and the GW-7553 is interrupted*  
Internal DIO and AIO data retain last value received

Please refer to section 5.4 about the safe value settings

- c. Byte order is an important factor related to the memory allocation. Big-endian byte order (Motorola format) allocates more significant byte in lower memory address. On the other hand, little-endian byte order (Intel format) allocates more significant byte in higher memory address.
- d. When Output Data Mode is “Auto”, the GW-7553 will update the value of the output and input module automatically. When Output Data Mode is “Manual”, the GW-7553 will update the value of the input module automatically and the user must update manually the value of the output module (please refer to section 4.6.2 Data Output Command).
- e. Modbus device ID is a Modbus address of the GW-7553, when the GW-7553 acts as a Modbus Slave device.
- f. We recommend the user to set the “query message timeout value” bigger than 3ms in order to identify the response message.
- g. The user can set the maximum number of Modbus TCP Slave device by “TCP\_Connect\_Num”. These Modbus TCP Slave devices can have different IP Address for connection.
- h. (M) means the parameter is effective, when Modbus Type of GW-7553 is Master.  
(S) means the parameter is effective, when Modbus Type of GW-7553 is Slave.  
(T) means the parameter is effective, when Modbus Format of GW-7553 is TCP.

## 4.4 The Configuration of the modules

The user can set the number and size of the I/O modules in the PROFIBUS

configuration tool. The settings of the modules are described below.

- Max. I/O modules : 32 modules
- System setting module : 3 byte output , 6byte input
- Output module : Output Relay/Coil => 1~32 Bytes  
Output Register => 1~64 Words
- Input module : Input Relay/Coil => 1~32 Bytes  
Input Register => 1~64 Words
- Max. length of I/O data : 480 Bytes
- Output length : 0~240 Bytes
- Input length : 0~240 Bytes

Note:

The user must add “System setting module” at the first module before the other modules, else the GW-7553 will send the diagnostic messages to PROFIBUS Master and the system will be abnormal.

The modules have module parameters about the communication settings. The module parameters are shown in the below :

A. Output Relay/Coil module parameters :

- Modbus Slave Device ID(M) : 0~247
- Start Address(M) : 0~65535
- NO. of Relay/Coil(M) :  $8*(n-1)+1 \sim 8*n$  Bits  
n=Module size/Byte
- TCP\_Connect\_Index(T)(M) : 1~8

B. Output Register module parameters :

- Modbus Slave Device ID (M) : 0~247
- Start Address(M) : 0~65535
- Change Word Order : Enable/Disable (Even module only)
- TCP\_Connect\_Index(T)(M) : 1~8

C. Input Relay/Coil module parameters :

- Modbus Slave Device ID (M) : 0~247
- Start Address(M) : 0~65535
- NO. of Relay/Coil(M) :  $8*(n-1)+1 \sim 8*n$  Bits  
n=Module size/Byte

- Module Type(M) : Read DI/DO
- TCP\_Connect\_Index(T)(M) : 1~8

D. Input Register module parameters :

- Modbus Slave Device ID (M) : 0~247
- Start Address(M) : 0~65535
- Module Type(M) : Read AI/AO
- Change Word Order : Enable/Disable (Even module only)
- TCP\_Connect\_Index(T)(M) : 1~8

**Example 1:**

If the user wants to read a Modbus digital input module (DI module), Device ID is 1, data address is 10010~10019, and data count is 10 via the first TCP connection.

In this case, the user can select an “Input Relay/Coil=> 2 Bytes module”, module parameters are shown in the below:

Input Relay/Coil module parameters :

- Modbus Slave Device ID(M) : 1
- Start Address(M) : 9
- NO. Of Relay/Coil(M) : 10
- Module Type(M) : Read DI
- TCP\_Connect\_Index(T)(M) : 1

**Example 2:**

If the user wants to write a Modbus analog output module (AO module), Device ID is 2, data address is 40001~ 40004 and data count is 4 via the second TCP connection.

In this case, the user can select an “Output Register => 4 Words module”, module parameters are shown in the below:

Output Register module parameters :

- Modbus Slave Device ID(M) : 2
- Start Address(M) : 0
- Change Word Order : Disable
- TCP\_Connect\_Index(T)(M) : 2

PS :

- a. Relay/Coil module is digital module (DI/DO module), the unit is Byte; Register module is analog module (AI/AO module), the unit is Word.
- b. Modbus Slave Device ID : It is a Modbus Slave device address.
- c. Start Address : The GW-7553 and Modbus Slave device exchange data from this starting address.
- d. NO. of Relay/Coil : It is data size that the GW-7553 and Modbus Slave device exchange.
- e. Module type : The user can select data type for data exchange by this setting.
  - Write DO(WDO)-- Write Digital Output
  - Write AO(WAO)-- Write Analog Output
  - Read DI(RDI)- Read Digital Input
  - Read DO(RDO)- Read Digital Output
  - Read AI(RAI)-Read Analog Input
  - Read AO(RAO)-Read Analog Output
- f. Change Word Order : When this setting is “Enable”, the GW-7553 will change the data between the high word and low word for reading easily.
- g. TCP\_Connect\_Index : The user can select TCP connection of the module. The module will transmit and receive data from this connection.

## 4.5 Diagnostic messages

The GW-7553 can record maximally 10 diagnostic messages at the same time. If the number of the diagnostic messages is bigger than 10, the GW-7553 will not process other diagnostic message. The diagnostic messages have four types. They are “Module Error”, “System Setting Module Error”, “EEPROM Error” and “Input Data Error”. The diagnostic messages are shown in **Table 14**.

*Table 14 Diagnostic messages*

Messages	Description	Note
Module 1~32 Error * (0x01-0x32)	ILLEGAL FUNCTION!(0x01)	Please refer Modbus Exception Code definition for detail.
	ILLEGAL DATA ADDRESS!(0x02)	
	ILLEGAL DATA VALUE!(0x03)	
	SLAVE DEVICE FAILURE!(0x04)	
	ACKNOWLEDGE!(0x05)	
	SLAVE DEVICE BUSY!(0x06)	

	NEGATIVE ACKNOWLEDGE!(0x07)	
	MEMORY PARITY ERROR!(0x08)	
	Modbus NOT DEFINED ERROR!(0x09)	
	GATEWAY PATH UNAVAILABLE!(0x0A)	
	DEVICE FAILED TO RESPOND!(0x0B)	
	CRC (LRC) Error!(0xFD)	
	Response Message Timeout!(0xFE)	
	Response Message error!(0xF8)	
	Connection error!(0xF7)	
System setting module Error	Not find System setting module.(0x3D)	
	Position is not correct!(0x3E)	
EEPROM Error	Read safe value error.(0xFB)	
	Read IP error!(0xFA)	
	Write IP error!(0xF9)	
Data Error	PROFIBUS lose input data.(0x3C)	
	Lose PROFIBUS output data.(0x3F)	

“\*” These error messages are not supported when the GW-7553 act as a Modbus Slave.

PS:

Diagnostic message will shown in input data area of System setting module (Please refer to section 4.6.1)

Data Error :

a. GW-7553 acts as a Modbus Master

If the polling speed between the GW-7553 device and the Modbus Slave is faster than the data exchange rate between PROFIBUS Master and the GW-7553 then the PROFIBUS Master will not get all the data from the Modbus Slave and therefore a diagnostic message (“PROFIBUS lose input data”) will be send by the GW-7553 to the PROFIBUS Master

b. GW-7553 acts as a Modbus Slave

If the GW-7553 receives more telegram from the Modbus Master than it transmits to the PROFIBUS Master then a diagnostic message (“PROFIBUS lose input data”) will be send by the GW-7553 to the PROFIBUS Master.

c. When the GW-7553 receives a “data output command” (output byte 0) from system setting module, and this command didn’t increase in order (ex: 0->1, 1->2,..., 255->0), the GW-7553 will think that it lose some output data of the PROFIBUS Master and a diagnostic message (“Lose PROFIBUS output data”) will be sent by the GW-7553 to the PROFIBUS Master.

## 4.6 I/O data exchange

The I/O data exchange is decided by Modbus type of the GW-7553 (please refer section 4.3 The Configuration of the common parameters) between PROFIBUS Master device and the GW-7553. Output data area of PROFIBUS Master device is mapped into DO/AO memory of the GW-7553 and input data area of PROFIBUS Master device is mapped into DI/AI memory of the GW-7553, when Modbus type is Master. In the other way, Output data area of PROFIBUS Master device is mapped into DI/AI memory of GW-7553 and input data area of PROFIBUS Master device is mapped into DO/AO memory of GW-7553, when Modbus type is Slave (please refer section 3.1 PROFIBUS data exchange ).

### 4.6.1 Input data area

The maximum length of input data is 240 bytes. Before arrange the input module, the user must arrange and configure the system setting module. The first six bytes belong to diagnostic message, as shown in *table 15*. The user can get data and control I/O of Modbus Slave device or get DI/DO/AI/AO of the GW-7553 by read input module.

*Table 15 Input data area*

Module	Byte	Data	Description
System setting module (diagnostic message)	0		The number of Diagnostic messages
	1	00or05	Fixed value(The value is00 when byte 0 is 0, The value is 05 when byte 0 is not 0)
	2	00orA0	Fixed value(The value is00 when byte 0 is 0, The value isA0 when byte 0 is not 0)
	3		Message(refer to Table 14)
	4	00	Fixed value
	5		Description(refer to Table 14)
Input module	6~239	Data	Receive data



EX. Input data area in byte 0 ~ byte5 information is “04 05 A0 02 00 FE”,  
 ”04” means there are 4 diagnostic messages  
 “02” means “Module 2 error!”  
 “FE” means “Response Message Timeout!”

#### 4.6.2 Output data area and communication command

The maximum length of output data is 240 bytes. Before arrange the output module, the user must arrange and configure the system setting module. The first three bytes belong to communication commands, as shown in **Table 16**. The user can change data and I/O state of Modbus Slave device or DI/DO/AI/AO data of GW-7553 by modify data of output module.

Table 16 Output data area

Module	Byte	Bit Position								Description
		7	6	5	4	3	2	1	0	
System setting module	0									Data output command
	1	-	-	-	-	-	-	SM	DC	Control bit
	2									Output module select
Output module	3~239									Output data

- Data output command(byte 0)
  - a. When Modbus type is Master  
 When this byte is changed, PROFIBUS Master device will send data of output module to DO/AO data of GW-7553 and then GW-7553 will send query message to Modbus Slave device for change data or output state of Modbus Slave device.
  - b. When Modbus type is Slave  
 When this byte is changed, PROFIBUS Master device will send data of output module to DO/AO data of GW-7553.

PS: When the user use this byte to trigger “data output command”, the

user must increase this byte in order (ex: 0->1, 1->2,..., 255->0) or else the GW-7553 will send a diagnostic message to the PROFIBUS Master (please refer section 4.5 Diagnostic messages).

- Control bit(byte 1)

DC(bit 0) : When this bit is set (DC=1), diagnostic messages sent by the GW-7553 module will all be cleared.

SM(bit 1) : When this bit is set (SM=1), the GW-7553 will enter setup mode. The utility can communicate with the GW-7553 in this mode.

When this bit is "0" (SM=0), the GW-7553 will enter normal operation mode. The GW-7553 can communicate with Modbus device in this mode.

Bit 2~7 : The remaining bits have to be set to zero.

- Output module select(byte 2)

When this byte is '0' and the user change data output command(byte 0), it will trigger all data output command of output modules.

When this byte isn't '0' and the user change data output command(byte 0), it will trigger single data output command of the output module and this byte represent module address of the output module (ex: "byte 2"=3, it represent that the user want to trigger data output command of the third module )

## 4.7 Establish connection with GW-7553

Before establishing a connection between the DP-Master and the GW-7553, user should execute the following steps first.

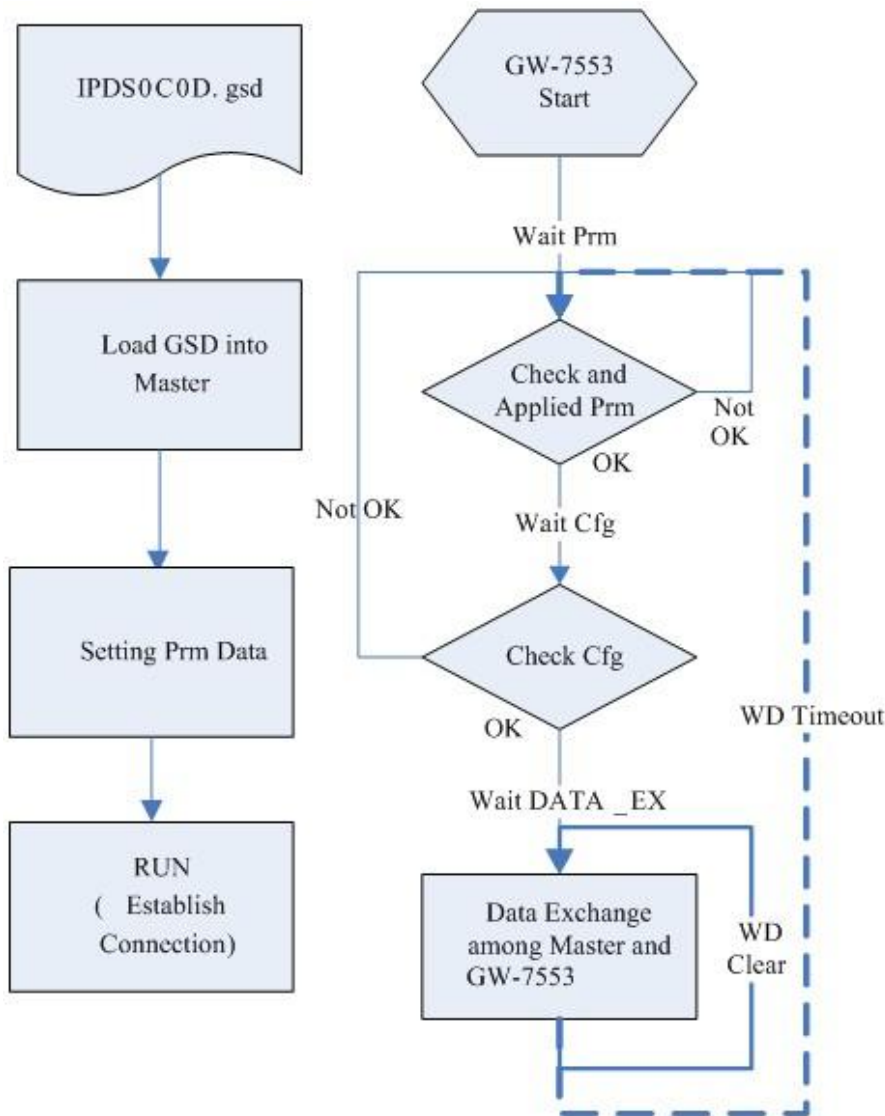

Figure 33 Establish connection with GW-7553

First, users must load the electronic device description file (GSD file) of the GW-7553 into the DP-Master, and then set the parameters. Finally change your DP-Master from Offline state to Operate state. While DP-Master changes to operate mode, GW-7553 will initial the modules. Then GW-7553 allocates the memory space and waits for Set\_Prm telegram. The next step is waiting for Check\_Cfg telegram in order. If there is no error occurs, GW-7553 proceeds into data exchange state. Users can observe the status indicator LED to know the state of GW-7553. At the meantime, if there is any error occurs, GW-7553 will return to wait parameterization.

#### 4.8 Data exchange example—Modbus RTU

In this example a Modbus Master device simulated by a PC program sends query

message and receives response message from a PROFIBUS Master via the GW-7553 gateway.

In the following examples the CIF50-PB PROFIBUS Master card from Hilscher is used. The configuration and communication is done by the program “SyCon” provided by Hilscher.

Step 1: Copy the GSD file and assign the GW-7553 a valid station address (Please refer to the section 4.2 GSD file).

Step 2: Connect the RS-232 port of the GW-7553 module to a COM port of the PC and the PROFIBUS port to a PROFIBUS Master (**Figure 34**).

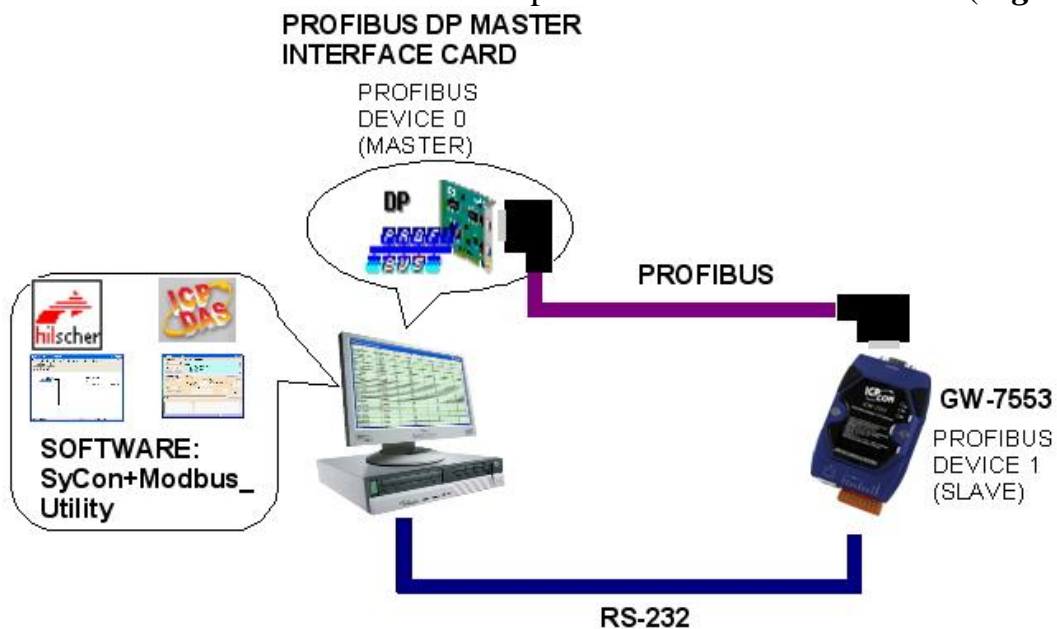

*Figure 34* Wiring diagram between PC and GW-7553

Step 3: Set the parameters of the GW-7553. We just need to change “Modbus Type” to Slave and the default setting is being used in the other parameters for this example. Please refer to section 4.3 the Configuration of the common parameters. The users can set parameters as shown in the below.

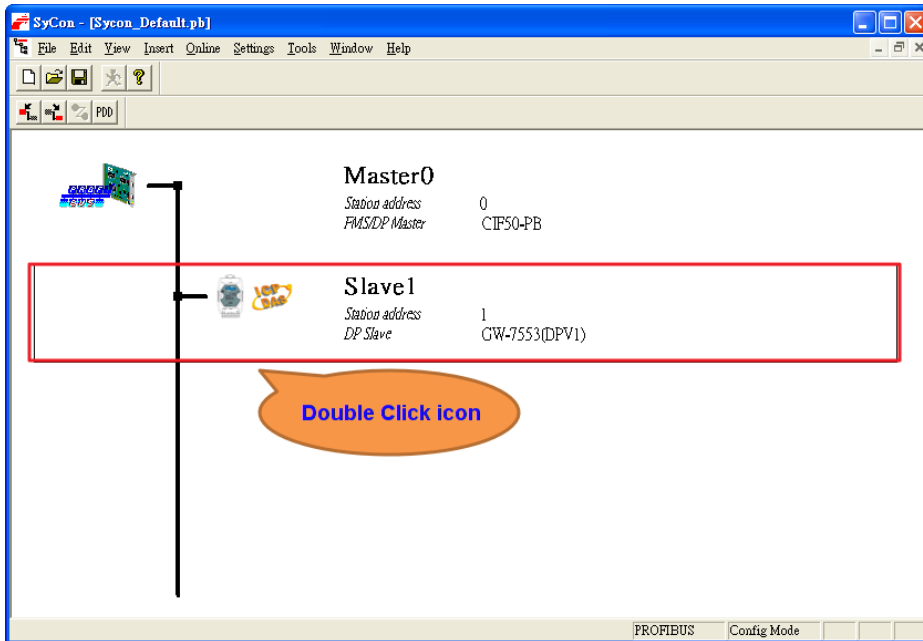

Figure 35 Double click the GW-7553 icon to open the “Slave configuration” window

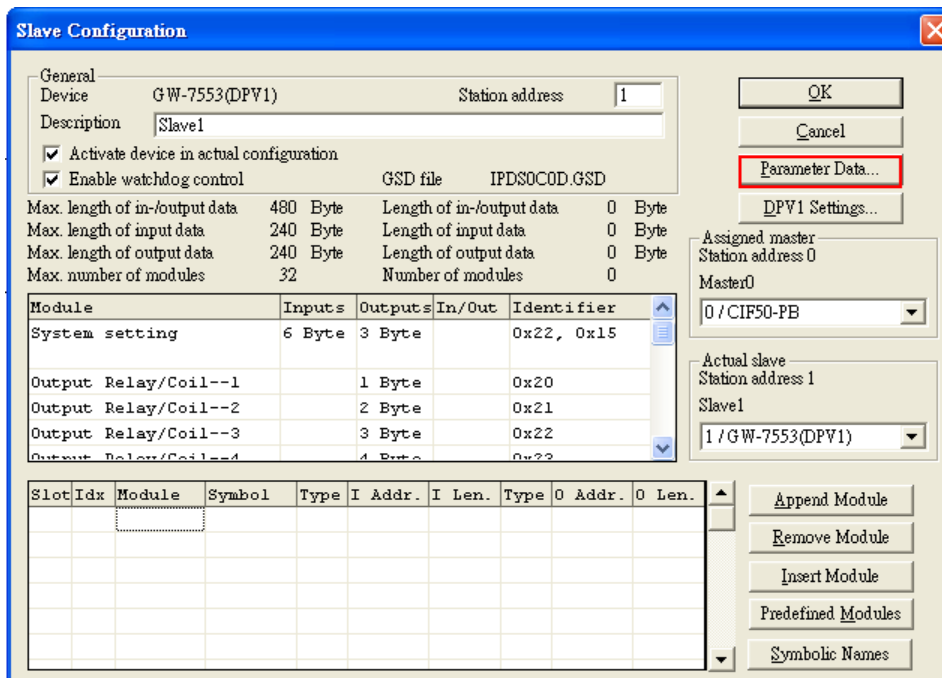

Figure 36 Click “Parameter Data...” button to open the “Parameter Data” window

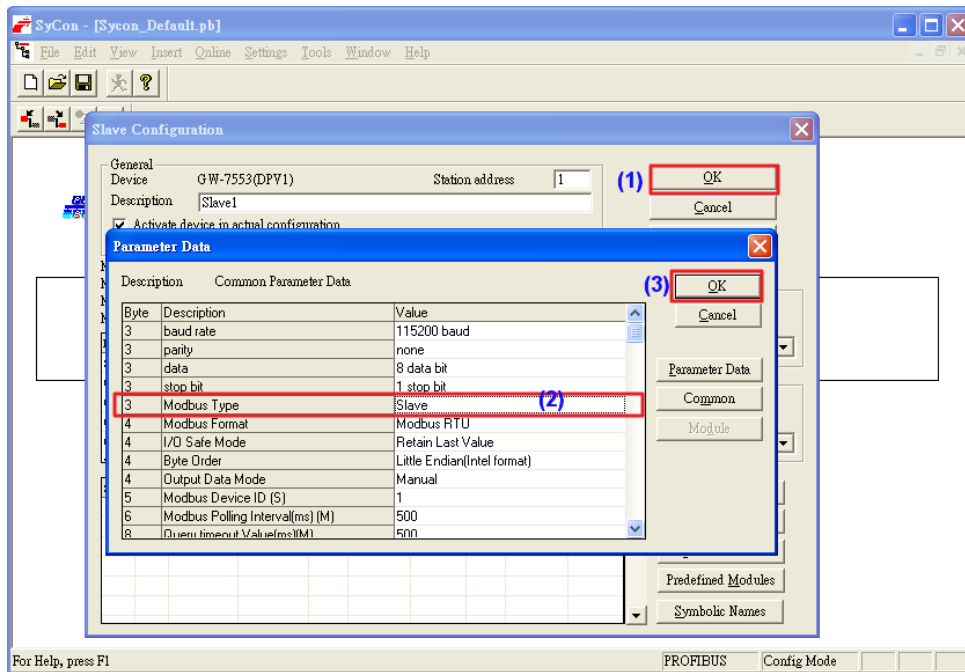

Figure 37 The user needs to change “Modbus Type” to Slave for this example and click “OK” button

Step 4: Set the GW-7553 modules, as shown in **Figure 38** and **Figure 39**.

- Select “System setting” module: “System setting” module always has to be selected otherwise no communication can be established between the gateway and the Modbus network.
- Select “Output Relay/Coil” module: In this example a “Output Relay/Coil--2 Byte” module is selected.
- Select “Input Relay/Coil” module: In this example a “Input Relay/Coil--2 Byte” module is selected.
- Select “Output Relay/Coil” module: In this example a “Output Register--1 word” module is selected.

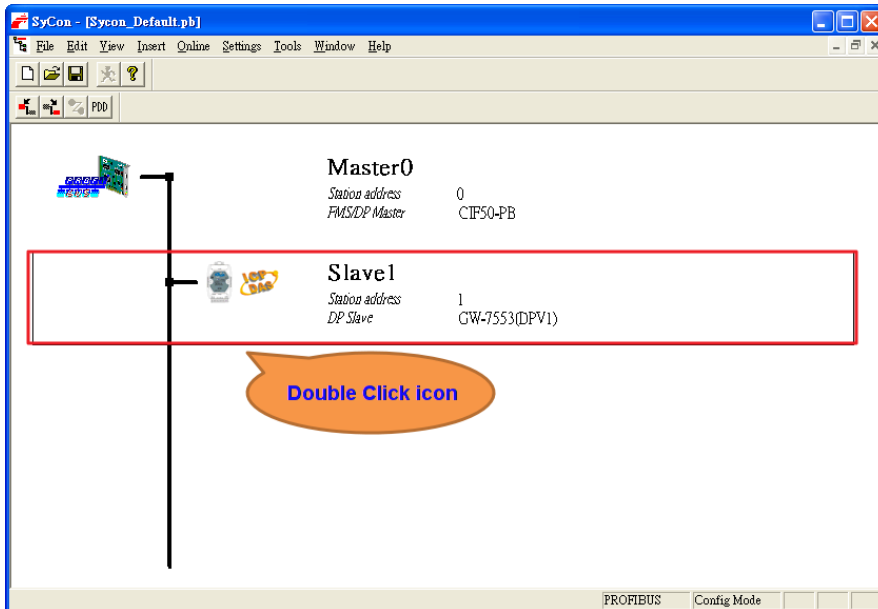

Figure 38 Double click the GW-7553 icon to open the “Slave configuration” window

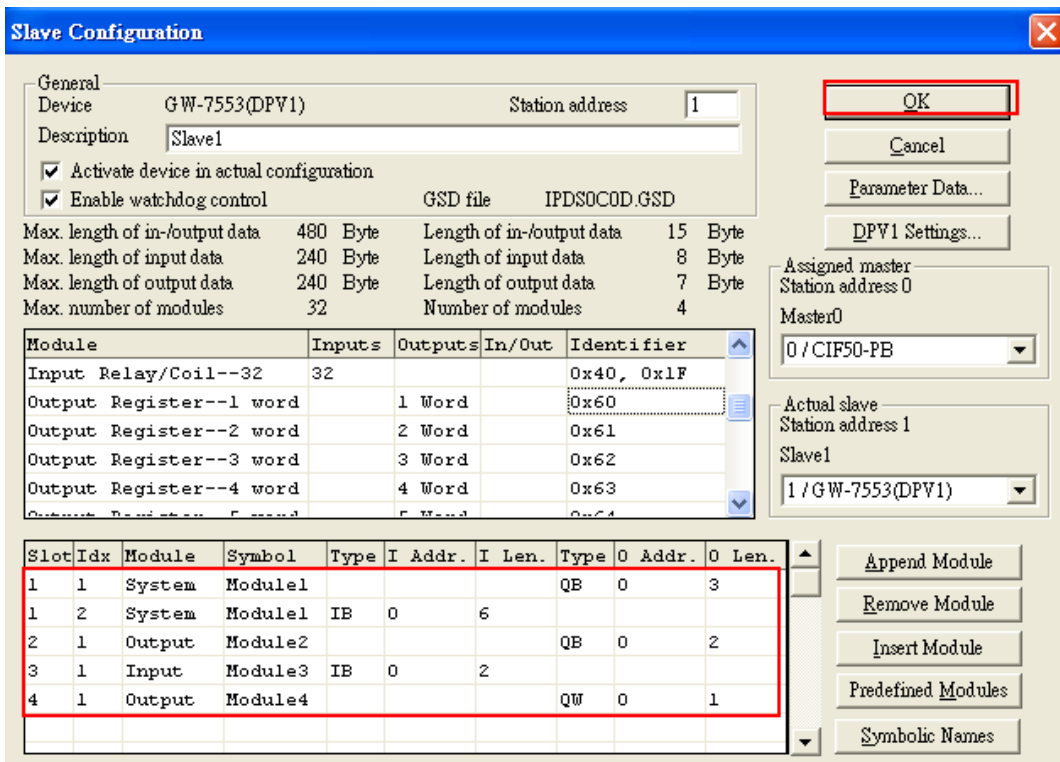

Figure 39 Select modules

Step 5: Close the “Slave Configuration” window by clicking the “OK” button.

Step 6: Now the setting done by the configuration tool has to be downloaded to the PROFIBUS Master.

Click on the Master area in the graphic window then  
**Online -> Download...**

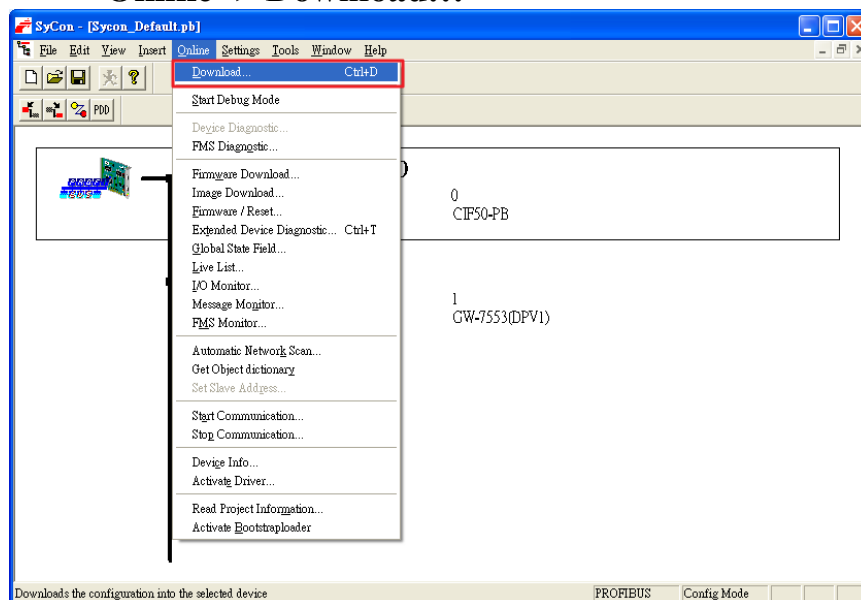

Figure 40 Click “Online->Download” to download the setting into PROFIBUS Master

#### 4.8.1 Sending data from a Modbus Master device

-- Start the test utility “MBRTU” (*Figure 41*) on the PC.

This utility simulates a Modbus Master device and is on the web site in the following directory:

[http://ftp.icpdas.com.tw/pub/cd/8000cd/napdos/modbus/modbus\\_utility/](http://ftp.icpdas.com.tw/pub/cd/8000cd/napdos/modbus/modbus_utility/)

- (1) Set the COM Port number of the PC
- (2) Set the Baud rate to 115200
- (3) Set the Line control to N,8,1
- (4) Open the connection



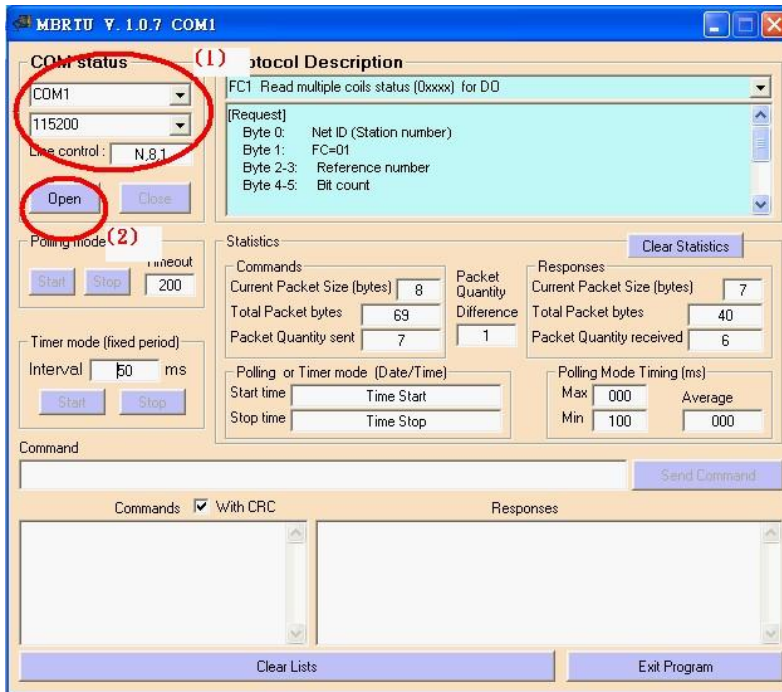

Figure 41 MBRTU Utility

--Send Command to write DO of the GW-7553

The user needs to input command ("01 0F 00 00 00 10 02 FF FF") here and click <Send Command> button to send Modbus command: "01 0F 00 00 00 10 02 FF FF E3 90" and then MBRTU can receive response message ("01 0F 00 00 00 10 54 07"). The user can find byte 6, 7 of the input data area in the configuration program "SyCon" have changed into "0xFF" at this time, as shown in the below.

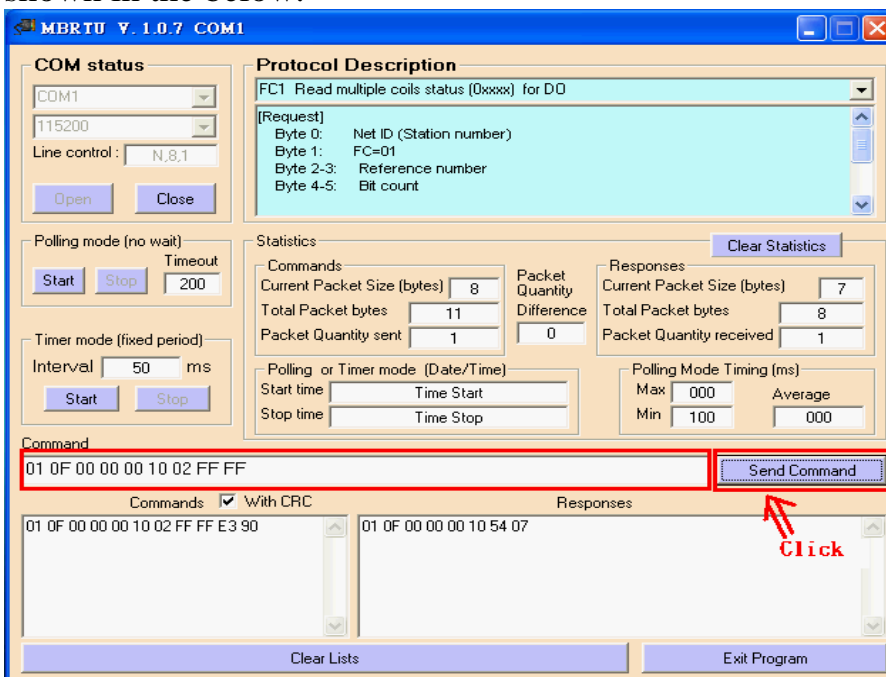

Figure 42 Send Modbus command (output data: 0xFF, 0xFF)

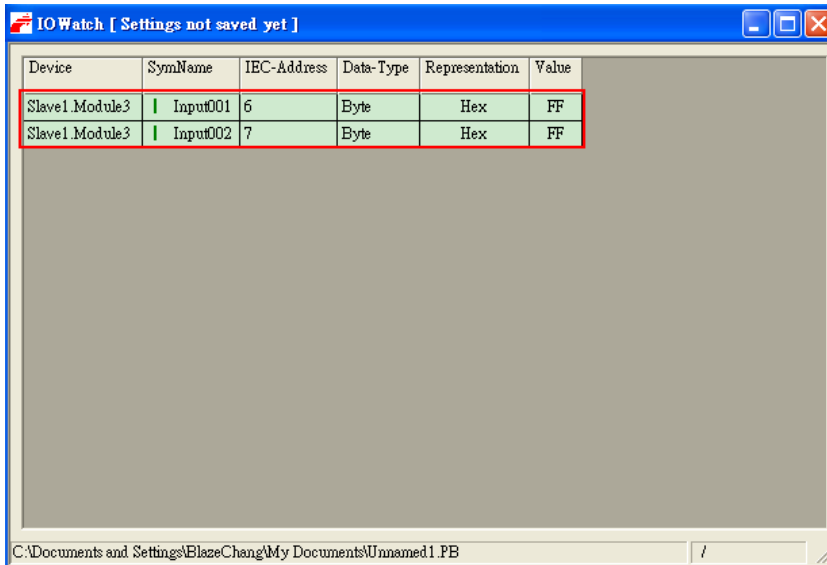

Figure 43 Receive “0xFF” in the input data area

Table 17 Receive “0xFF” in the input data area

Module	Byte	Data type	Representation	Value
Input module	Input 6	Byte	Hex	0xFF
	Input 7	Byte	Hex	0xFF

PS:

Modbus command:

Query message

DA	FC	SA (Hi)	SA (Lo)	NO (Hi)	NO (Lo)	BC	DATA		CRC check	
01	0F	00	00	00	10	02	FF	FF	E3	90

Response message

DA	FC	SA (Hi)	SA (Lo)	NO (Hi)	NO (Lo)	CRC check	
01	0F	00	00	00	10	54	07

- DA: Device Address-0x01
- FC: Function Code-0x0F=>Write multi-DO
- SA(Hi): Start Address(Hi byte)-0x00
- SA(Lo): Start Address(Lo byte)-0x00
- NO(Hi): No. Of points (Hi byte)-0x00
- NO(Lo): No. Of points (Lo byte)-0x10
- BC: Byte Count-0x02

#### 4.8.2 Using PROFIBUS DP-V1 to read data from a PROFIBUS Master Device

--Send Command to write DO of the GW-7553

In section 4.8.1. The user can find byte 6, 7 of the input data area in the configuration program “SyCon” have changed into “0xFF”.

--“Message Monitor”

Message Monitor is provided by Sycon, user can click **Online->Message Monitor** menu. User must enter parameters relative to DPV1 in the message monitor in order to read/write data via DPV1 from a profibus slave.

The message monitor is shown in *Figure 44*.

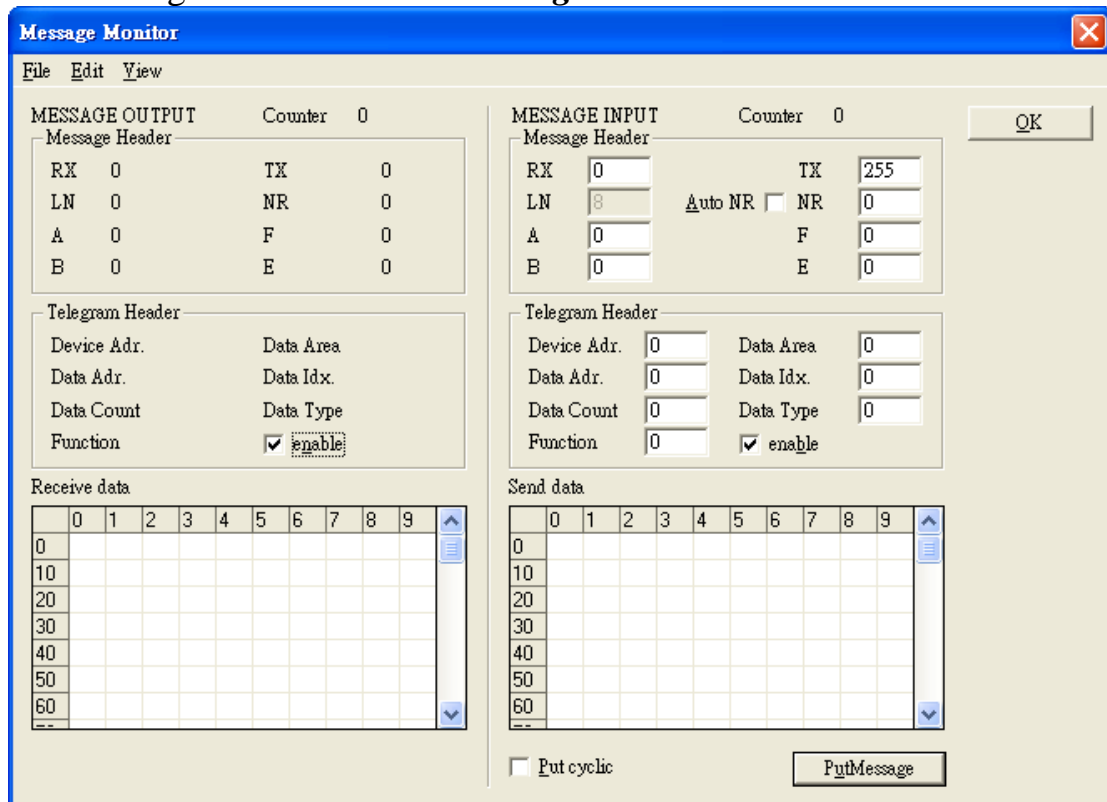

*Figure 44* “Message Monitor”

--Sending Initiate request telegram to establish connection between Profibus Master and GW-7553

If configure CIF50-PB as a class 1 master, user do not establish connection.

If configure CIF50-PB as a class 2 master, user must establish connection.

Please click **Online->Message Monitor**, then fill in parameters relative to Initiate request telegram, as shown in *Figure 45* and *Table 18*.

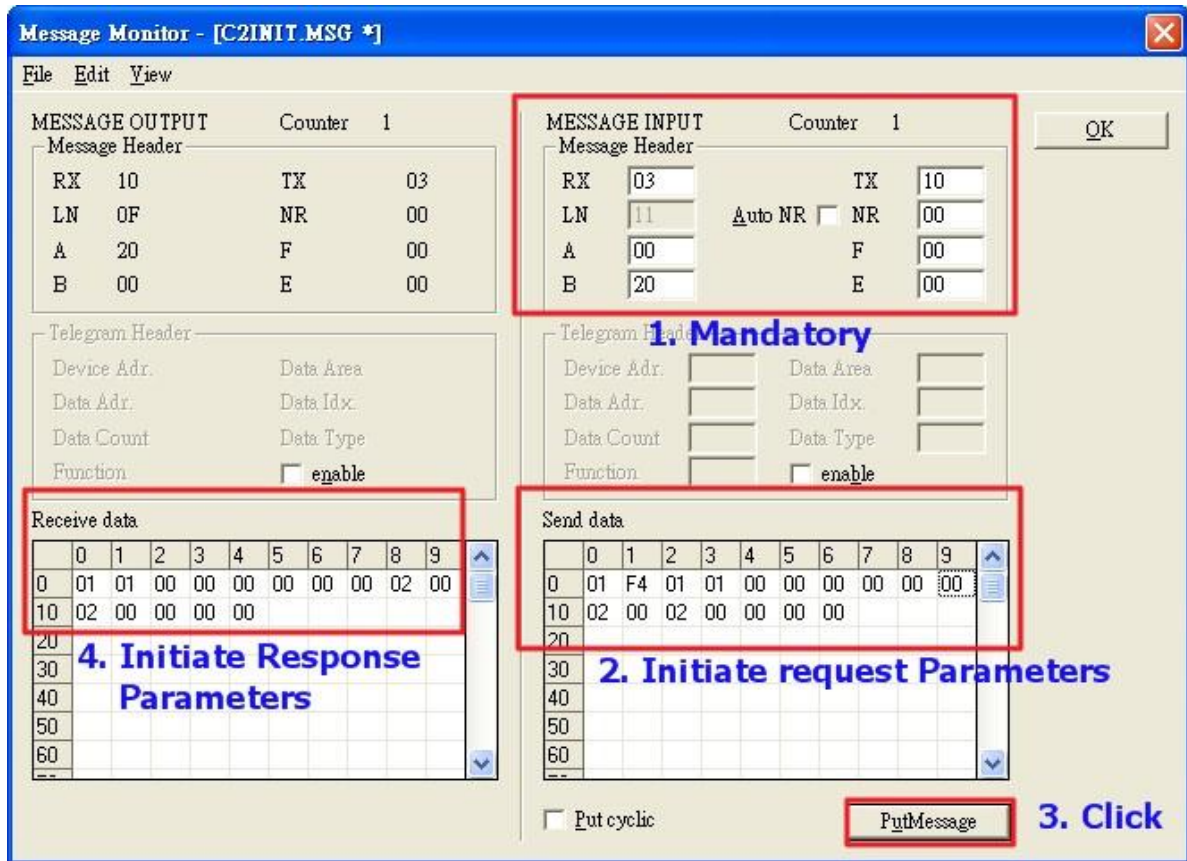

Figure 45 Initiate request Parameters

Table 18 Send data Parameters

Parameters	Value	Parameters	Value
PROFIBUS station address of GW-7553	0x01	S-Type	0x00
Send Timeout (Lo)	0xF4	S-Len	0x02
Send Timeout (Hi)	0x01	D-Type	0x00
Features Supported 1	0x01	D-Len	0x02
Features Supported 2	0x00	S_Addr API	0x00
Profile Features Supported 1	0x00	S_Addr SCL	0x00
Profile Features Supported 2	0x00	D_Addr API	0x00
Profile Ident Number (Lo)	0x00	S_Addr SCL	0x00
Profile Ident Number (Hi)	0x00		

--Sending Read request telegram to read data of the GW-7553

If configure CIF50-PB as a class 1 master, 《Message Header->B》 is 0x11

If configure CIF50-PB as a class 2 master, 《Message Header->B》 is 0x21

Please click **Online->Message Monitor**, then fill in parameters relative to Read request telegram, as shown in *Figure 46*、*Figure 47* and *Table 19* Telegram Header Parameters .

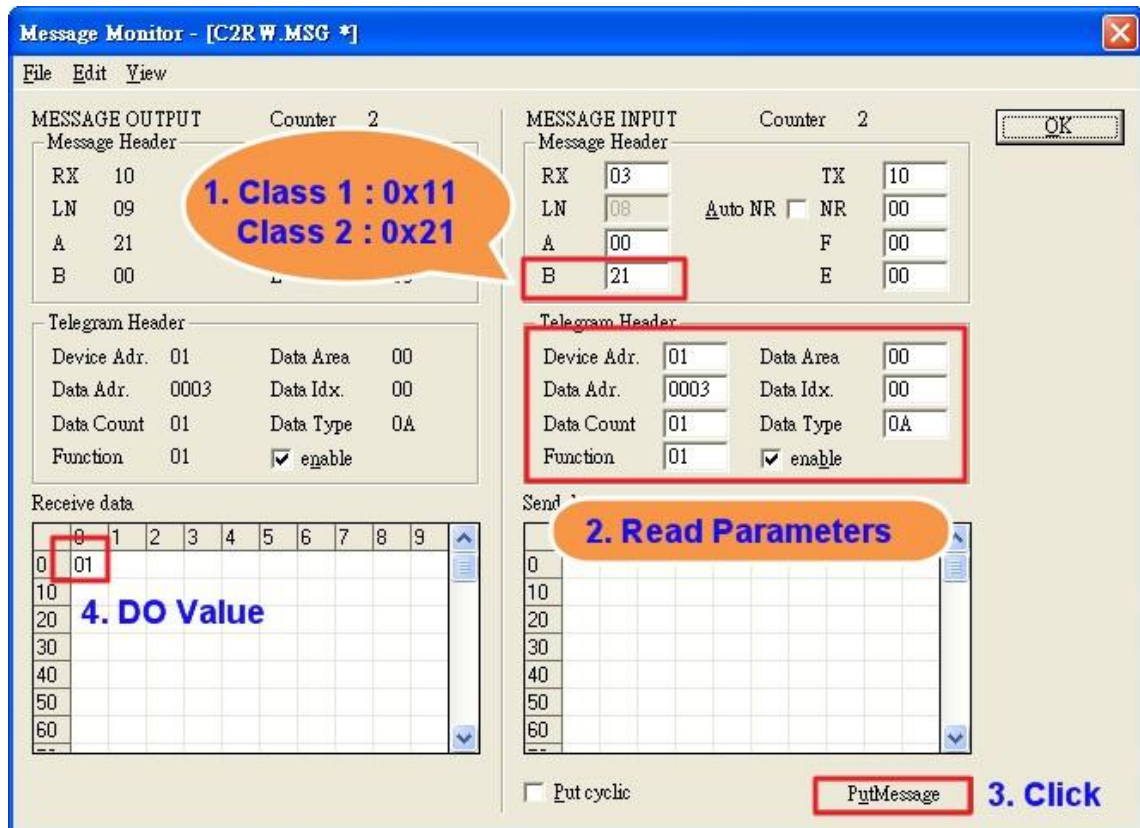

Figure 46 Read request Parameters

Table 19 Telegram Header Parameters

Parameters	Value	Meaning for DPV1
Device Adr.	0x01	PROFIBUS station address of GW-7553
Data Area	0x00	Unused
Data Adr.	0x03	Slot number
Data Idx.	0x00	Index
Data Count	0x01	Length
Data Type	0x0A	Unused
Function	0x01	Read

In this case, slot 3 is used for “Input Relay/Coil--2 Byte” (see *Figure 39* Select

modules), the DO value of index 0 is “0x01”.

Index	15	14	13	12	11	10	9	8	7	6	5	4	3	2	1	0
Input data	1	1	1	1	1	1	1	1	1	1	1	1	1	1	1	1
Input data(Hex)	FF								FF							

Figure 47 Index range

-- Sending Abort request telegram to terminate connection between Profibus Master and GW-7553

If configure CIF50-PB as a class 1 master, user do not terminate connection. If configure CIF50-PB as a class 2 master, user must terminate connection. Please click **Online->Message Monitor**, then fill in parameters relative to Abort request telegram, as shown in *Figure 48*.

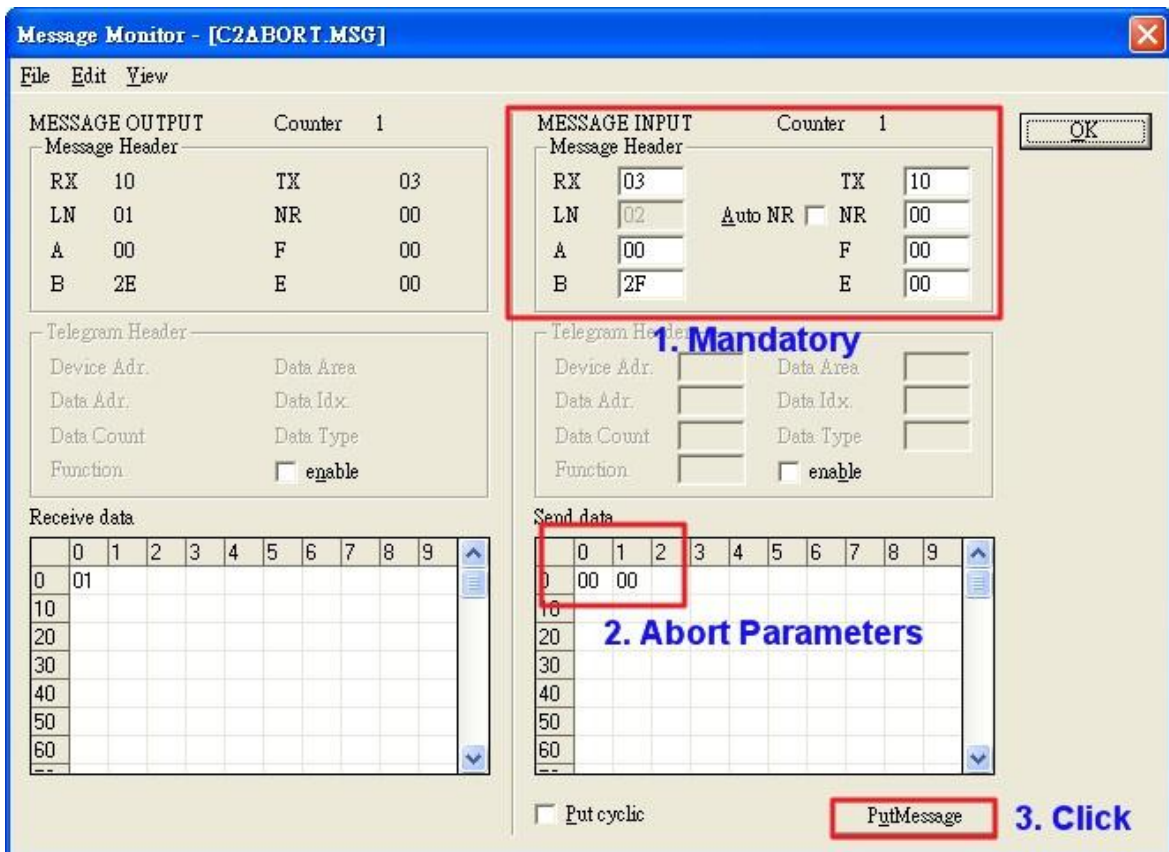

Figure 48 Abort request Parameters

### 4.8.3 Receiving data from the PROFIBUS Master device

--Send Command to read DI of the GW-7553

The user needs to input command (“ 01 02 00 00 00 10”) in MBRTU and

click <Send Command> button to send Modbus command: “01 02 00 00 00 10 79 C6” and then MBRTU can receive response message (“ 01 02 02 00 00 B9 B8”). In this message, the user can know the value of DI0 & DI1 is “0” in the GW-7553.

--Send output data to write DI of the GW-7553 by the PROFIBUS Master  
 The user needs to set “0xFE” & “0xDC” in byte 3 & byte 4 of output data area in the configuration program “SyCon” and then set the value of the first byte from 0 to 1 to trigger the data output command.

--Send Command to read DI of the GW-7553 again  
 Now the user can input command (“ 01 02 00 00 00 10”) in MBRTU and click <Send Command> button to send Modbus command: “01 02 00 00 00 10 79 C6” again. Then MBRTU can receive response message (“ 01 02 02 FE DC F8 41”). In this message, the user can know the value of DI0 & DI1 have changed into “0xFE” & “0xDC” in the GW-7553, as shown in **Figure 49**, **Figure 50** , **Figure 51** & **Table 20** Set output data and trigger output data command.

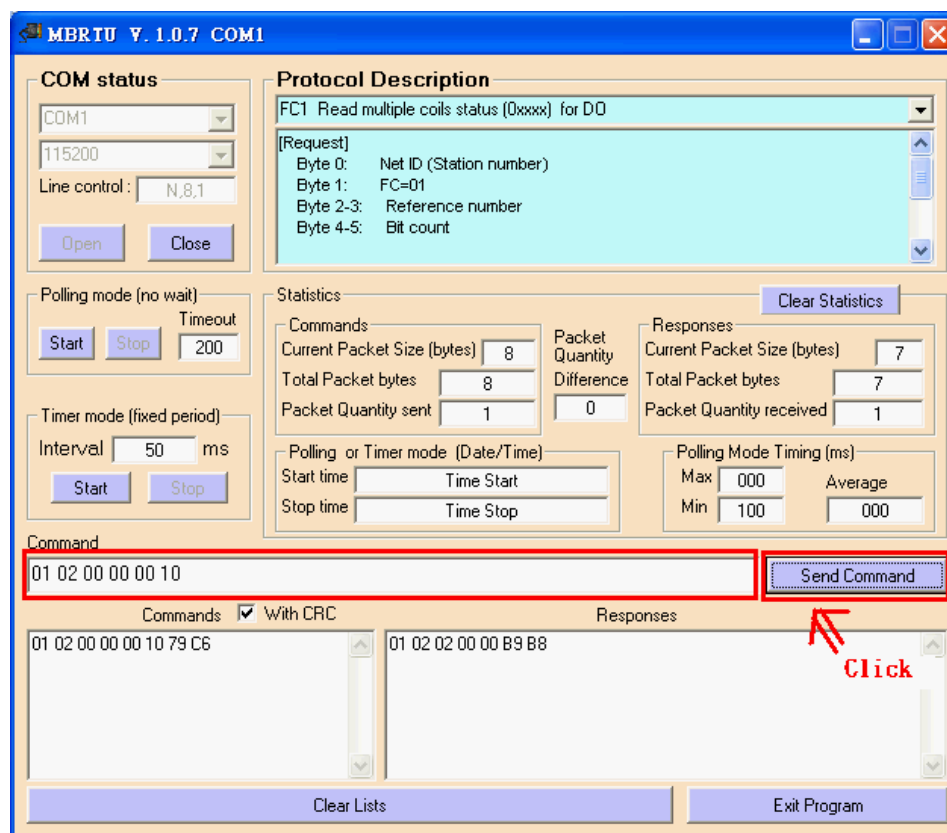

**Figure 49** Send Modbus command to read DI of the GW-7553

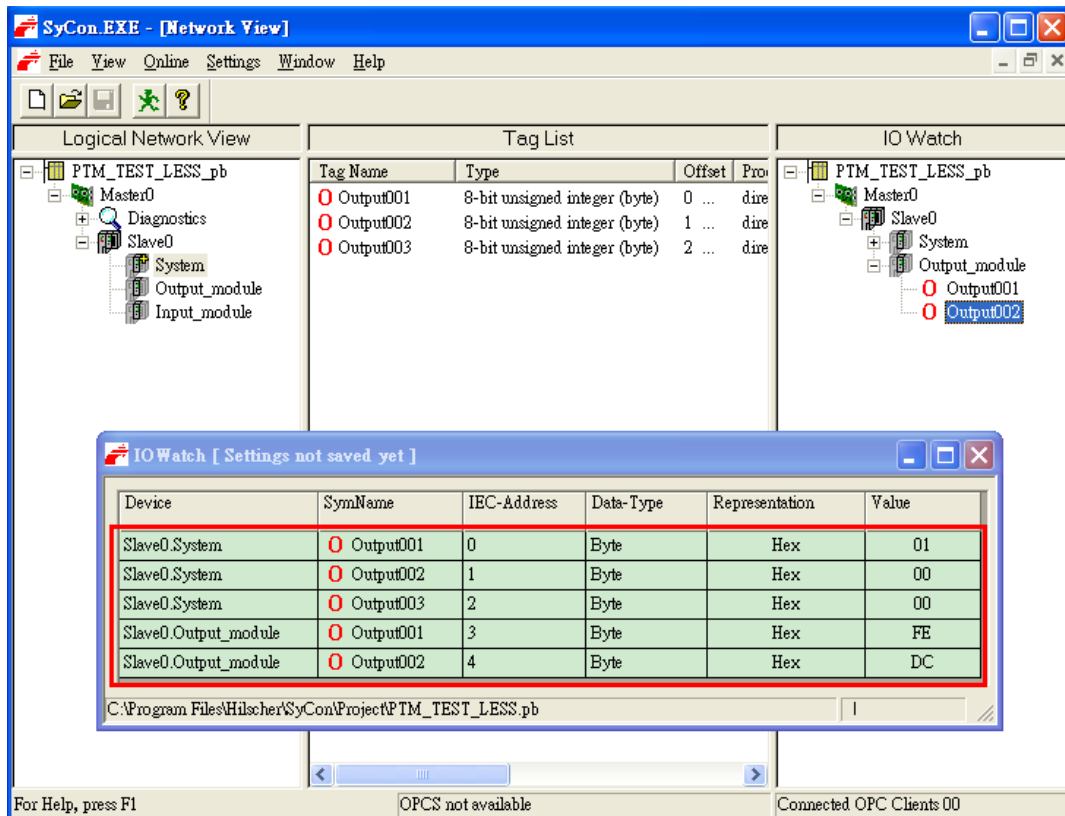

Figure 50 Set output data and trigger output data command in the output data area

Table 20 Set output data and trigger output data command

Module	Byte	Data type	Representation	Value
System module	Output 0	Byte	Hex	0x00 → 0x01
	Output 1	Byte	Hex	0x00
	Output 2	Byte	Hex	0x00
Output module	Output 3	Byte	Hex	0x00 → 0xFE
	Output 4	Byte	Hex	0x00 → 0xDC



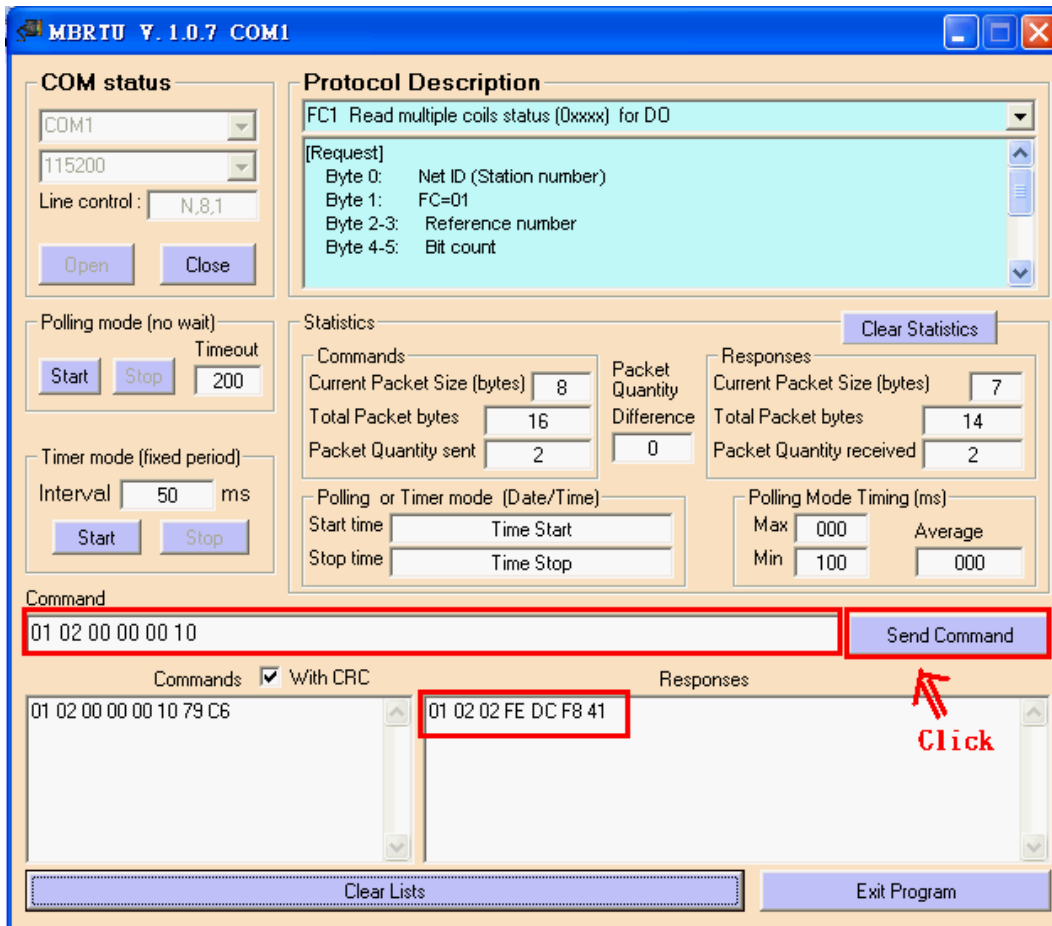

Figure 51 Send Modbus command to read DI of the GW-7553 and receive data (0xFE, 0xDC)

PS:

Modbus command:

Query message

DA	FC	SA (Hi)	SA (Lo)	NO (Hi)	NO (Lo)	CRC check	
01	02	00	00	00	10	79	C6

Response message

DA	FC	BC	DATA		CRC check	
01	02	02	FE	DC	F8	41

- DA: Device Address-0x01
- FC: Function Code-0x02:read DI
- SA(Hi): Start Address(Hi byte)-0x00
- SA(Lo): Start Address(Lo byte)-0x00
- NO(Hi): No. Of points(Hi byte)-0x00
- NO(Lo): No. Of points (Lo byte)-0x10
- BC: Byte Count-0x02

#### 4.8.4 Using PROFIBUS DP-V1 to write data from a PROFIBUS Master Device

--Send Command to read AI of the GW-7553

The user needs to input command (" 01 04 00 00 00 01") in MBRTU and click <Send Command> button to send Modbus command: "01 04 00 00 00 01 31 CA" and then MBRTU can receive response message (" 01 04 02 00 00 B9 30"). In this message, the user can know the value of AI0 is "0x00,0x00" in the GW-7553.

-- Send output data to write AI of the GW-7553 by the PROFIBUS DP-V0

The user needs to set "0xAA" & "0xBB" in byte 5 & byte 6 of output data area in the configuration program "SyCon" and then increase the value of the first byte from 1 to 2 (in section 4.8.3, the value of the first byte is 1)to trigger the data output command.

--Send Command to read AI of the GW-7553

Now the user can input command (" 01 04 00 00 00 01") in MBRTU and click <Send Command> button to send Modbus command: "01 04 00 00 00 01 31 CA" again. Then MBRTU can receive response message (" 01 04 02 AA BB 87 E3"). In this message, the user can know the value of AI0 have changed into "0xAA" & "0xBB" in the GW-7553, as shown in **Figure 52**.

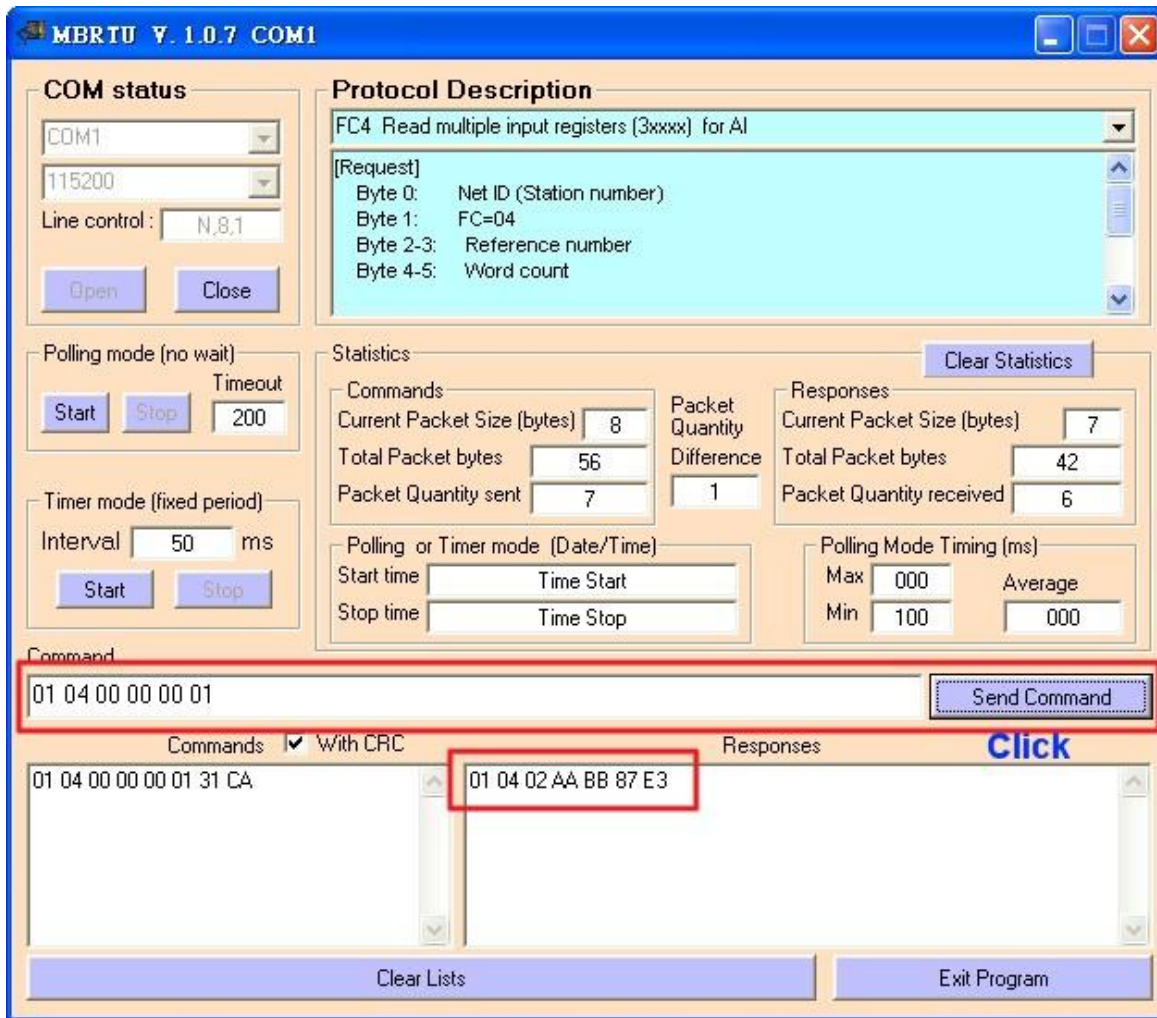

Figure 52 Send Modbus command to read AI of the GW-7553 and receive data (0xAA, 0xBB)

- Send output data to write AI of the GW-7553 by the PROFIBUS DP-V1  
 If configure CIF50-PB as a class 1 master, user do not establish connection.  
 If configure CIF50-PB as a class 2 master, user must establish connection.  
 After establish connection(please refer to section 4.8.2). User can fill in parameters relative to Write request telegram and set “0xCC” & “0xDD” in Send data area to write data to byte 5 & byte 6 of output data area, as shown in *Figure 53*.

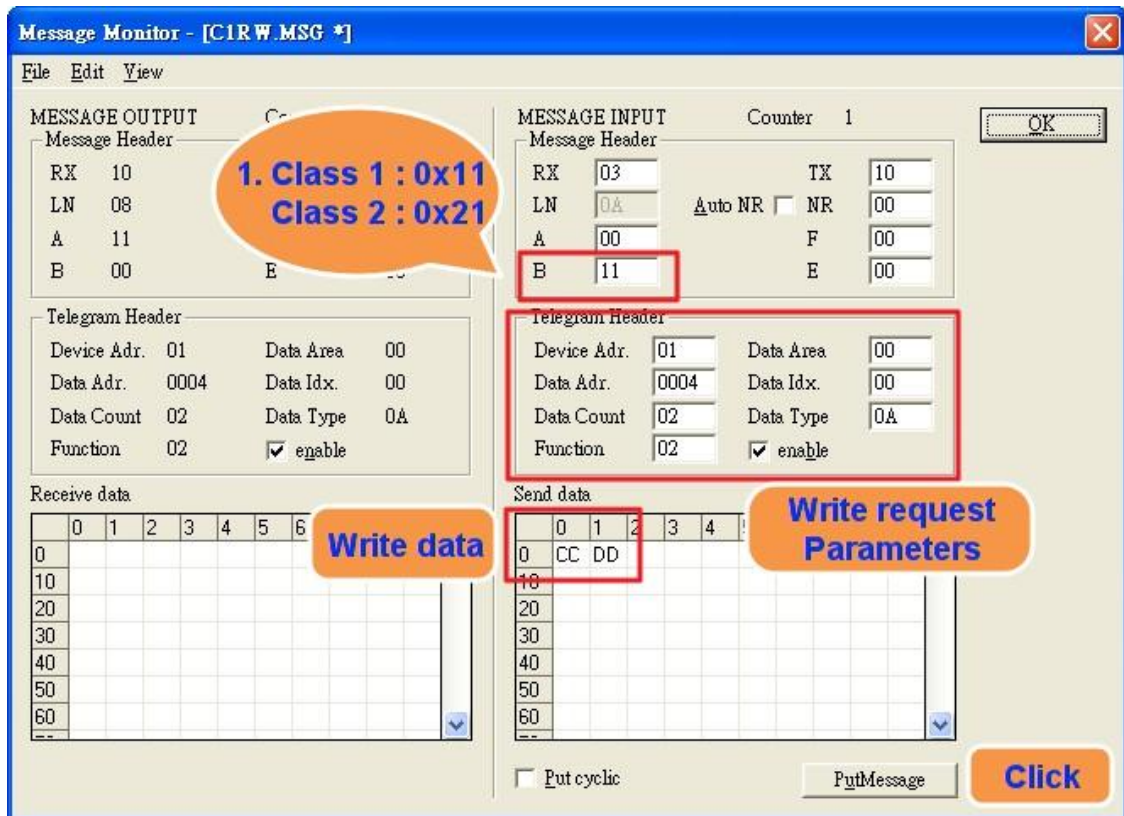

Figure 53 Write request Parameters

--Send Command to read AI of the GW-7553

Now the user can input command (" 01 04 00 00 00 01") in MBRTU and click <Send Command> button to send Modbus command: "01 04 00 00 00 01 31 CA" again. Then MBRTU can receive response message (" 01 04 02 CC DD 2C 69"). In this message, the user can know the value of AI0 have changed into "0xCC" & "0xDD" in the GW-7553, as shown in **Figure 54**.

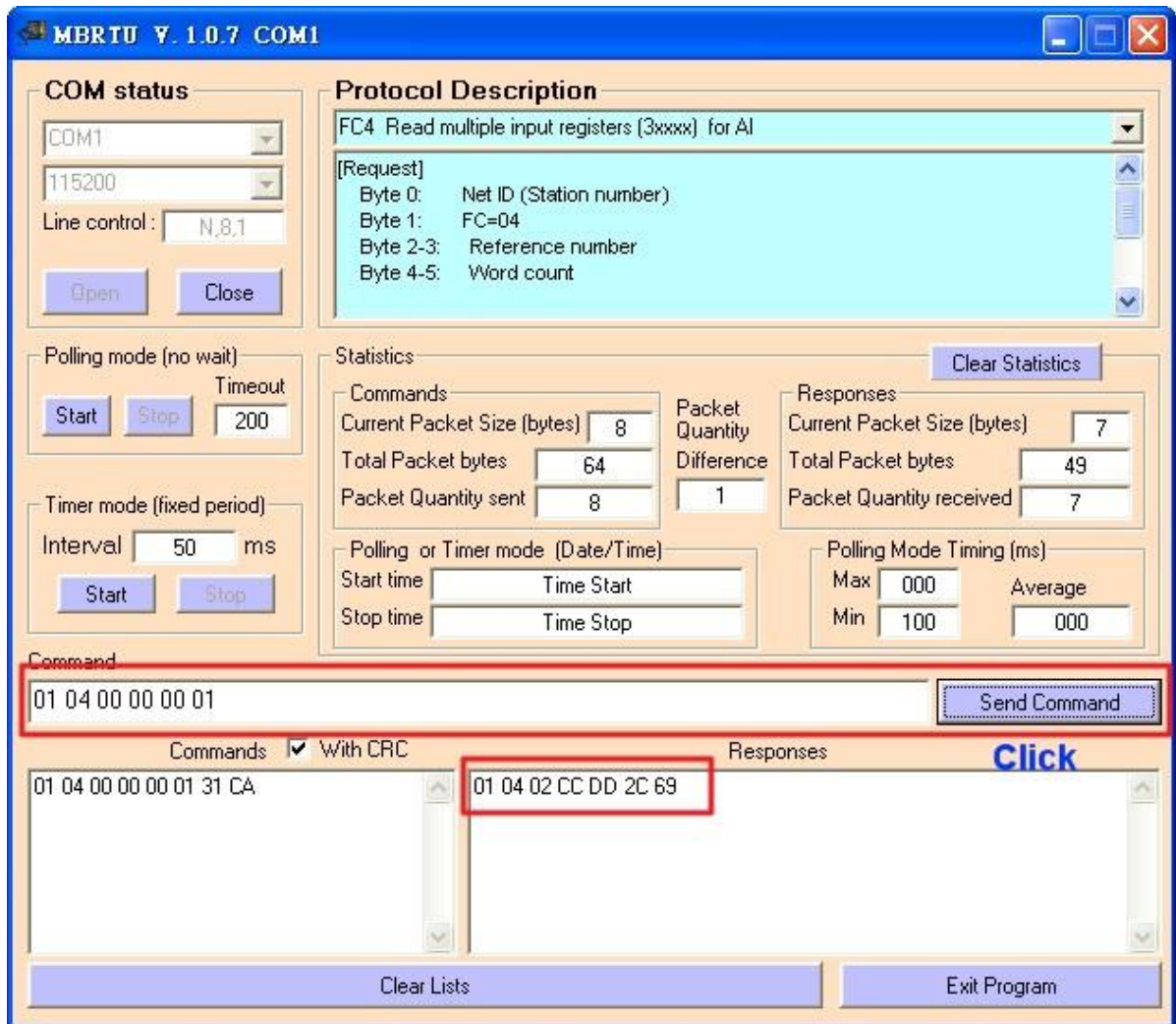

Figure 54 Send Modbus command to read AI of the GW-7553 and receive data (0xCC, 0xDD)

#### 4.9 Data exchange example—Modbus TCP

In this example a Modbus Master device simulated by a PC program sends query message and receives response message from a PROFIBUS Master via the GW-7553 gateway.

In the following examples the CIF50-PB PROFIBUS Master card from Hilscher is used. The configuration and communication is done by the program “SyCon” provided by Hilscher.

Step 1: Copy the GSD file and assign the GW-7553 a valid station address (Please refer to the section 4.2 GSD file).

Step 2: Connect GW-7553 and PC by *Figure 55*.

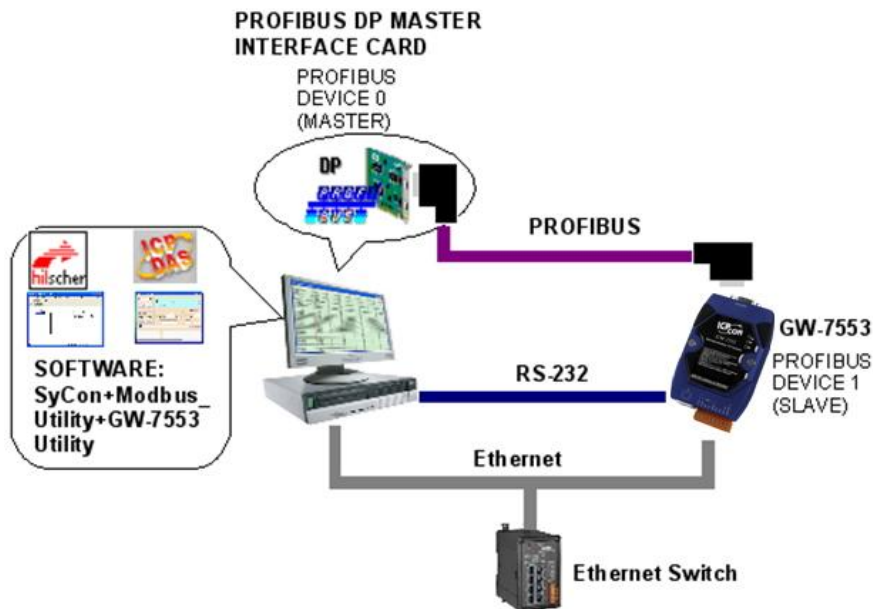

Figure 55 Wiring diagram between PC and GW-7553

Step 3: Set the parameters of the GW-7553. We need to change “Modbus Type” to Slave and “Modbus Format” to Modbus TCP. The default setting is being used in the other parameters for this example. Please refer to section 4.3 the Configuration of the common parameters. The users can set parameters as shown below.

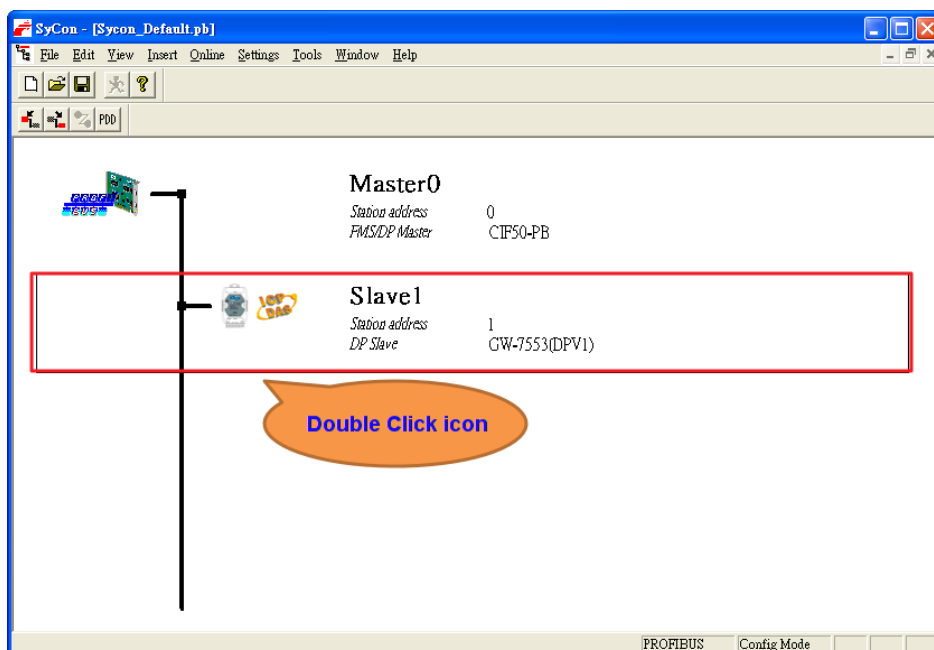

Figure 56 Double click the GW-7553 icon to open the “Slave configuration” window

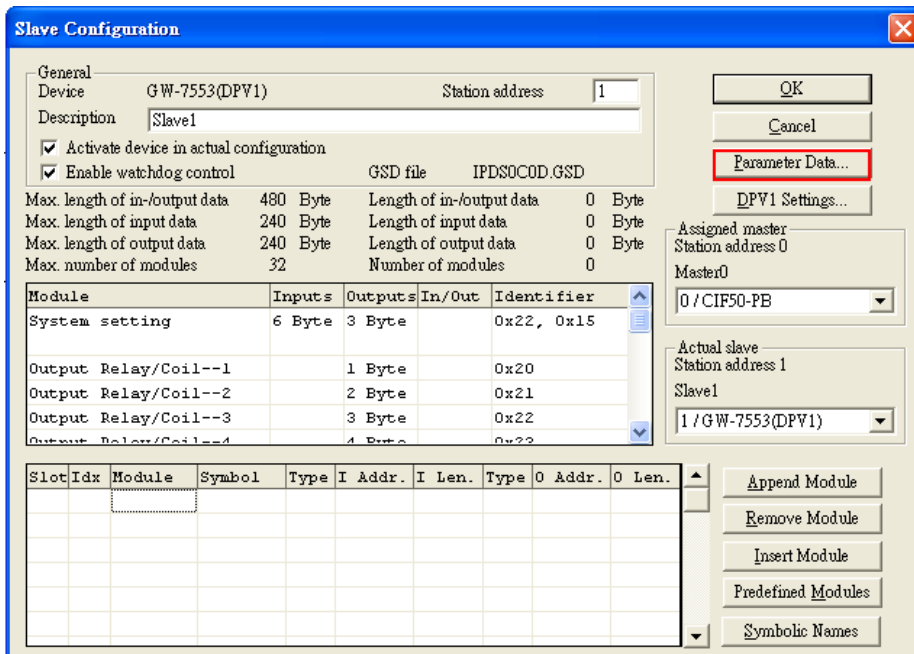

Figure 57 Click “Parameter Data...” button to open the “Parameter Data” window

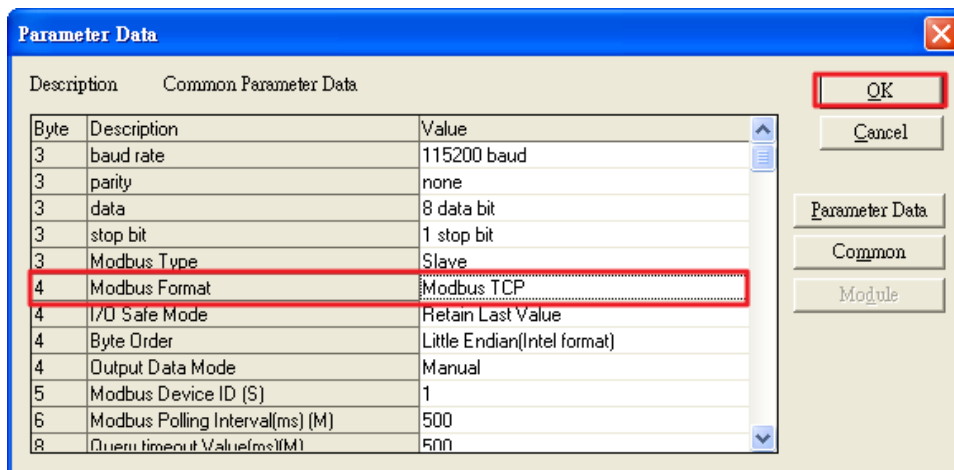

Figure 58 The user needs to change “Modbus Type” to Slave and “Modbus Format” to Modbus TCP for this example and click “OK” button

Step 4: Set the GW-7553 modules, as shown in **Figure 59** and **Figure 60**.

- Select “System setting” module: “System setting” module always has to be selected otherwise no communication can be established between the gateway and the Modbus network.
- Select “Output Relay/Coil” module: In this example a “Output Relay/Coil--2 Byte” module is selected.
- Select “Input Relay/Coil” module: In this example a “Input Relay/Coil--2 Byte” module is selected.

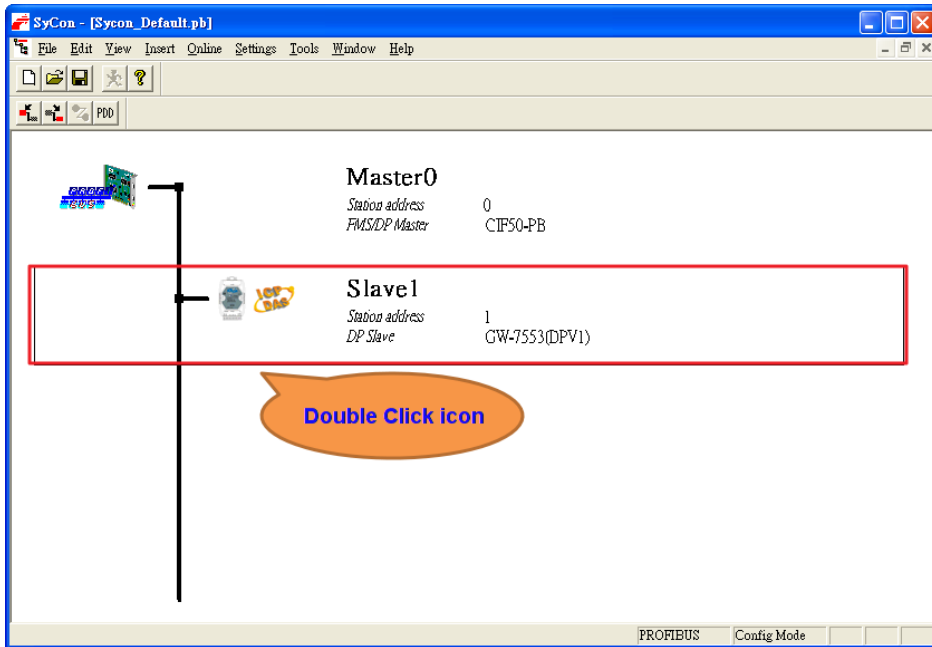

Figure 59 Double click the GW-7553 icon to open the “Slave configuration” window

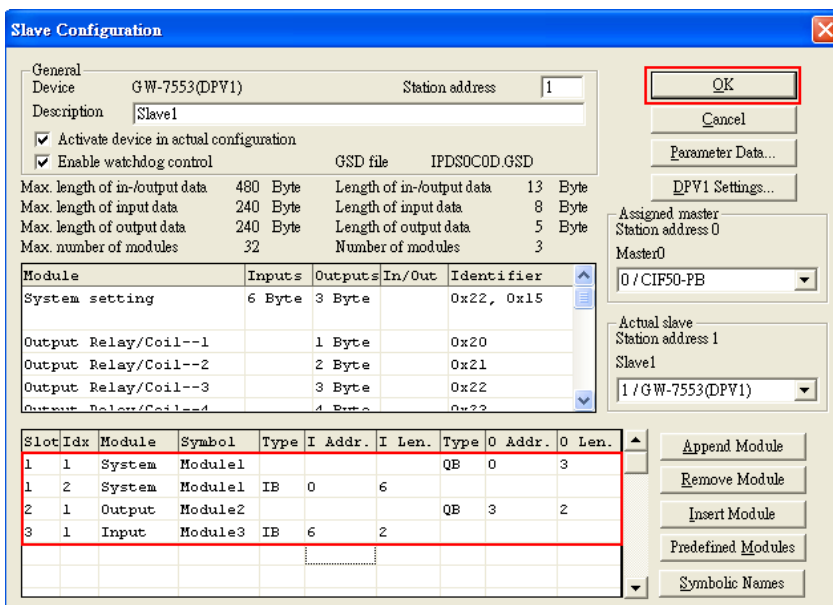

Figure 60 Select modules

Step 5: Close the “Slave Configuration” window by clicking the “OK” button.

Step 6: Now the setting done by the configuration tool has to be downloaded to the PROFIBUS Master.

Click on the Master area in the graphic window then



## Online -> Download...

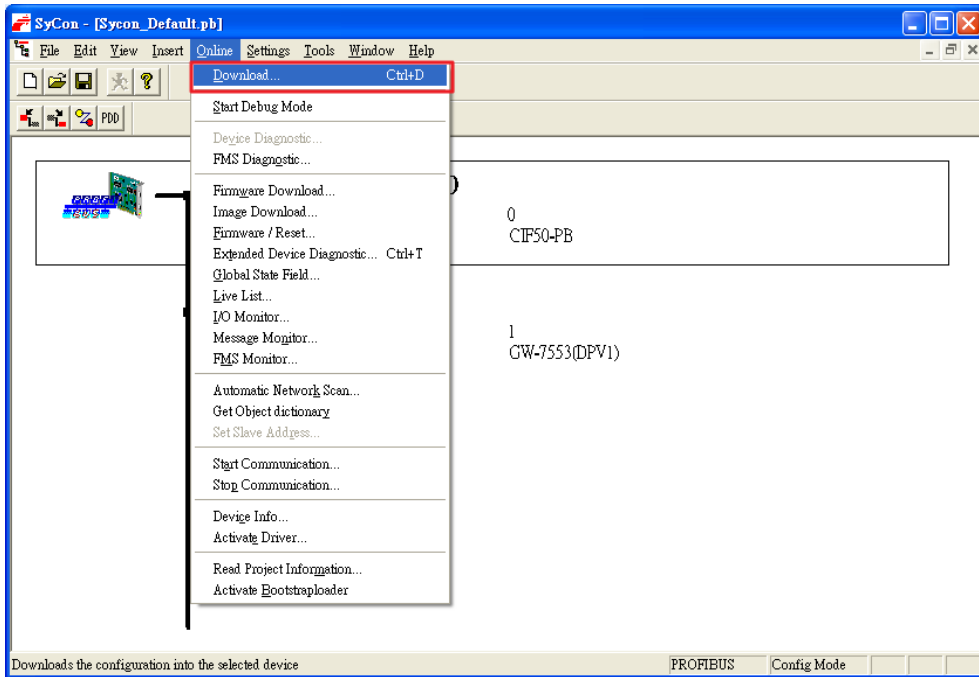

Figure 61 Click “Online->Download” to download the setting into PROFIBUS Master

Step 7: Set the network settings of the GW-7553 by PROFIBUS/Modbus gateway utility (please refer section 5.5 & 5.6). The settings of the GW-7553 must have the same domain and different IP with the PC (ex: PC’s IP=192.168.0.106, MASK=255.255.0.0; GW-7553’s IP=192.168.0.107, MASK=255.255.0.0).

Step 8: Reset the power of the GW-7553 for an active setting.

### 4.9.1 Receiving data from a Modbus Master device

-- Start the test utility “MBTCP” (*Figure 62*) on the PC.

This utility simulates a Modbus Master device and is on the web site in the following directory:

[http://ftp.icpdas.com.tw/pub/cd/8000cd/napdos/modbus/modbus\\_utility/](http://ftp.icpdas.com.tw/pub/cd/8000cd/napdos/modbus/modbus_utility/)

- (1) Set the IP address of the GW-7553
- (2) Click the connect button

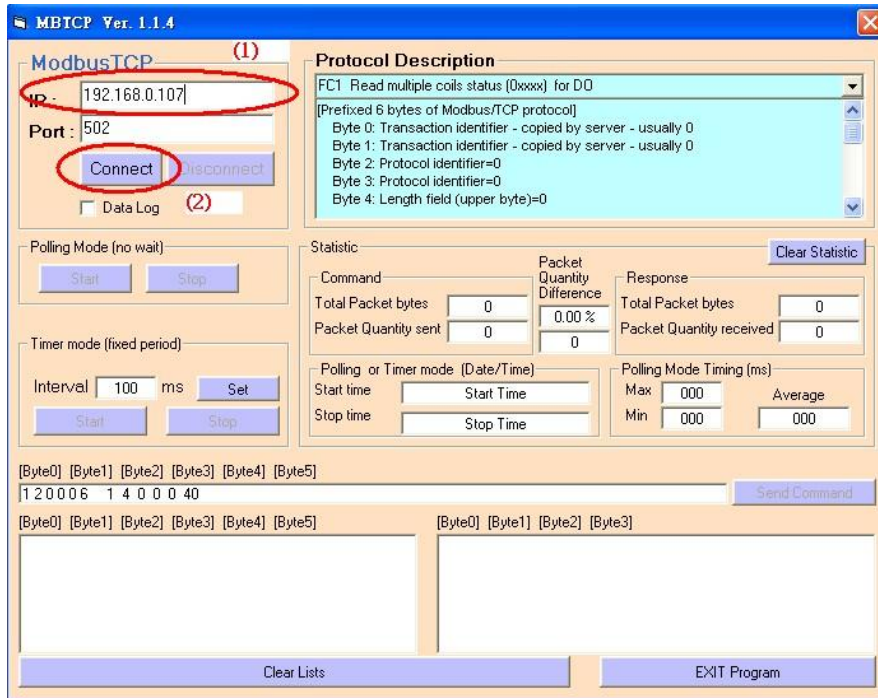

Figure 62 MBTCP Utility

--Send Command to write DO of the GW-7553

The user needs to input command ("01 0F 00 00 00 10 02 FF FF") here and click <Send Command> button to send Modbus command: "01 0F 00 00 00 10 02 FF FF" and then MBTCP can receive response message ("01 0F 00 00 00 10"). The user can find byte 6, 7 of the input data area in the configuration program "SyCon" have changed into "0xFF" at this time, as shown below.

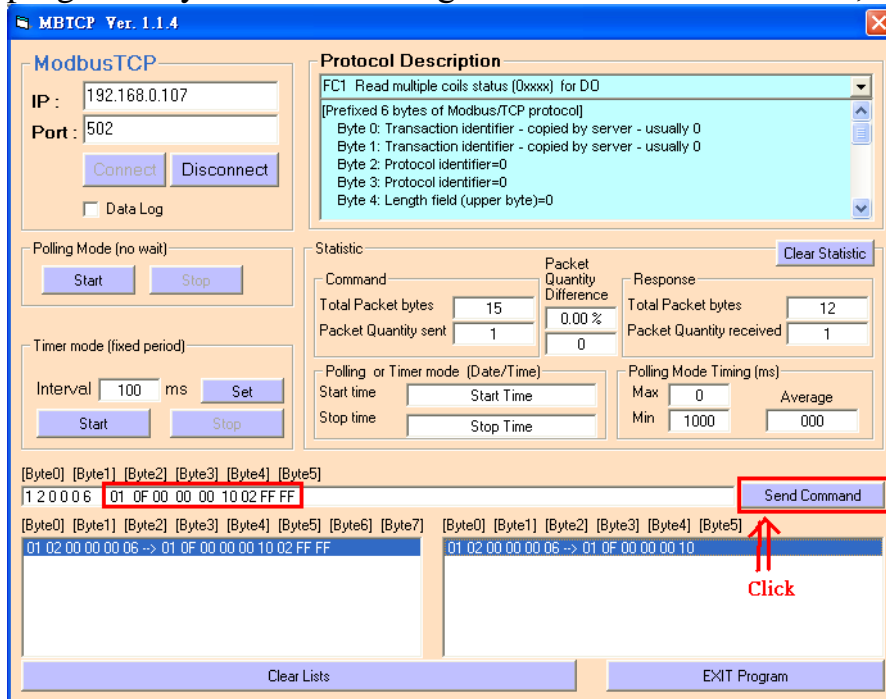

Figure 63 Send Modbus command (output data: 0xFF, 0xFF)

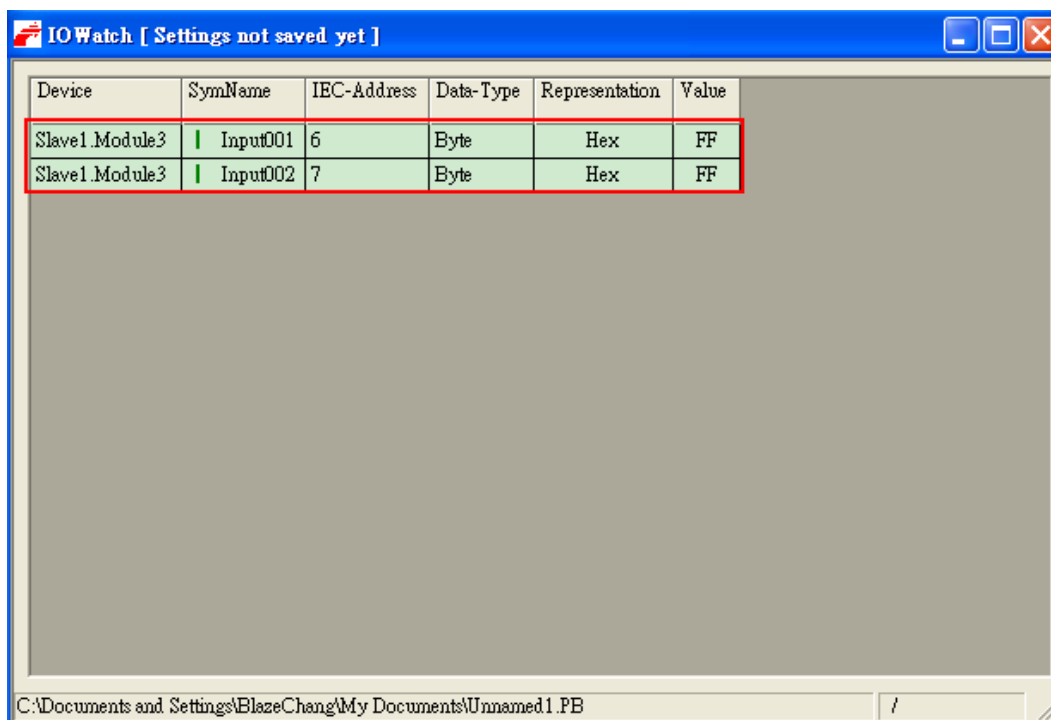

Figure 64 Receive “0xFF” in the input data area

Table 21 Receive “0xFF” in the input data area

<i>Module</i>	<i>Byte</i>	<i>Data type</i>	<i>Representation</i>	<i>Value</i>
Input module	Input 6	Byte	Hex	0xFF
	Input 7	Byte	Hex	0xFF

PS:

Modbus command:

Query message

DA	FC	SA (Hi)	SA (Lo)	NO (Hi)	NO (Lo)	BC	DATA	
01	0F	00	00	00	10	02	FF	FF

Response message

DA	FC	SA (Hi)	SA (Lo)	NO (Hi)	NO (Lo)
01	0F	00	00	00	10

- DA: Device Address-0x01
- FC: Function Code-0x0F=>Write multi-DO
- SA(Hi): Start Address(Hi byte)-0x00
- SA(Lo): Start Address(Lo byte)-0x00
- NO(Hi): No. Of points (Hi byte)-0x00
- NO(Lo): No. Of points (Lo byte)-0x10
- BC: Byte Count-0x02

#### 4.9.2 Receiving data from the PROFIBUS Master device

--Send Command to read DI of the GW-7553

The user needs to input command (" 01 02 00 00 00 10") in MBTCP and click <Send Command> button to send Modbus command: "01 02 00 00 00 10" and then MBTCP can receive response message (" 01 02 02 00 00"). In this message, the user can know the value of DI0 & DI1 is "0" in the GW-7553.

--Send output data to write DI of the GW-7553 by the PROFIBUS Master

The user needs to set "0xFE" & "0xDC" in byte 3 & byte 4 of output data area in the configuration program "SyCon" and then set the value of the first byte from 0 to 1 to trigger the data output command.

--Send Command to read DI of the GW-7553 again

Now the user can input command (" 01 02 00 00 00 10") in MBTCP and click <Send Command> button to send Modbus command: "01 02 00 00 00 10" again. Then MBTCP can receive response message (" 01 02 02 FE DC"). In this message, the user can know the value of DI0 & DI1 have changed into "0xFE" & "0xDC" in the GW-7553, as shown in *Figure 65*, *Figure 66*, *Figure 67*, & *Table 22* Set output data and trigger output data command.

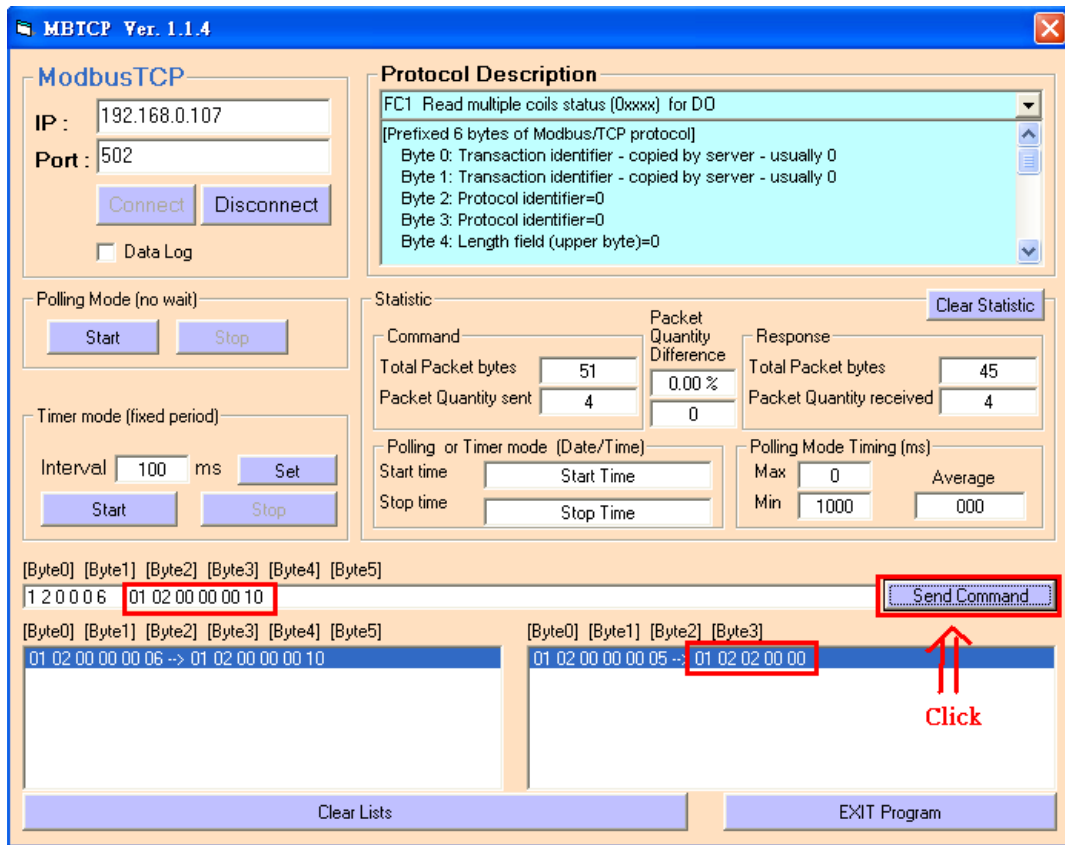

Figure 65 Send Modbus command to read DI of the GW-7553

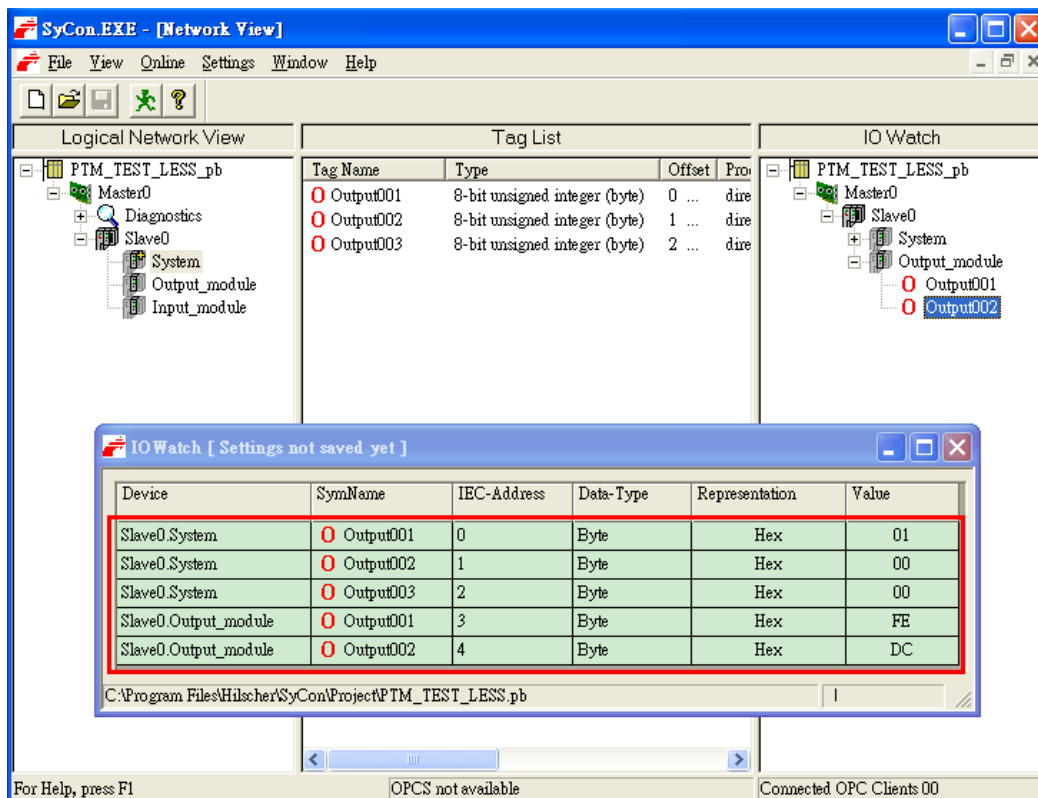

Figure 66 Set output data and trigger output data command in the output data area

Table 22 Set output data and trigger output data command

Module	Byte	Data type	Representation	Value
System module	Output 0	Byte	Hex	0x00 → 0x01
	Output 1	Byte	Hex	0x00
	Output 2	Byte	Hex	0x00
Output module	Output 3	Byte	Hex	0x00 → 0xFE
	Output 4	Byte	Hex	0x00 → 0xDC

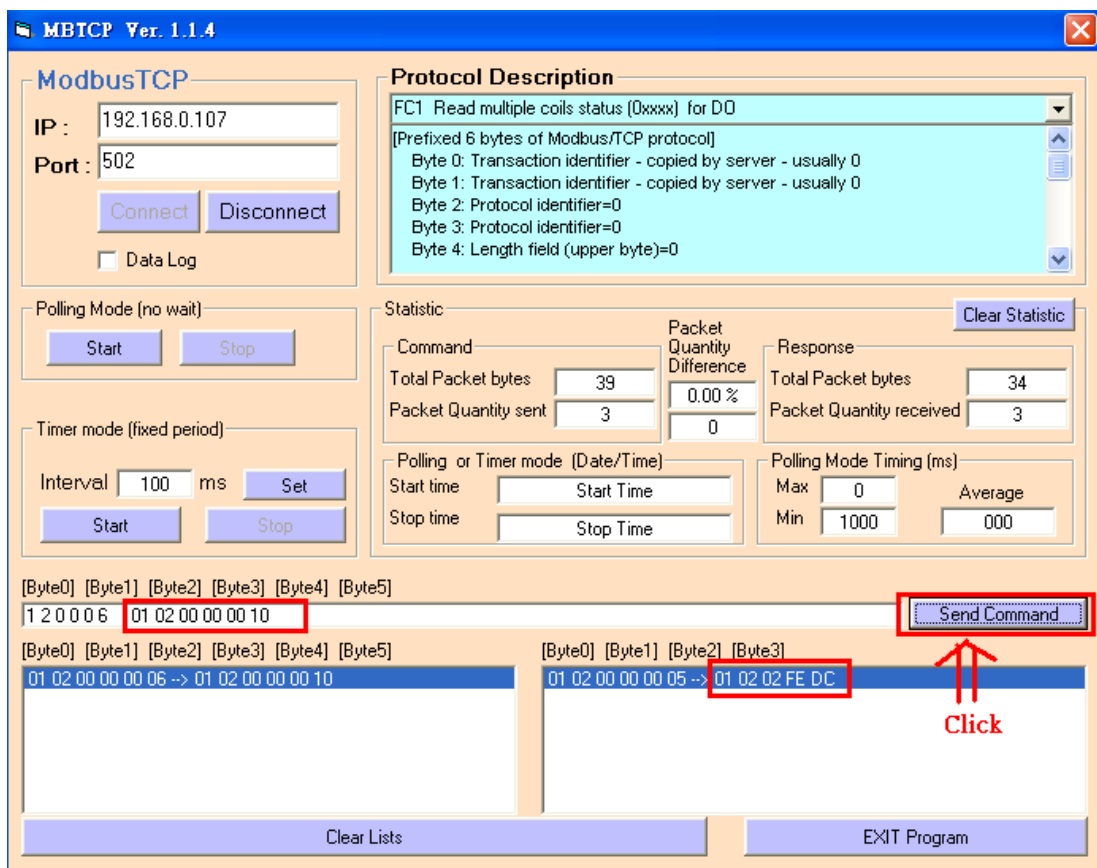

Figure 67 Send Modbus command to read DI of the GW-7553 and receive data (0xFE, 0xDC)

PS:

Modbus command:

Query message

DA	FC	SA (Hi)	SA (Lo)	NO (Hi)	NO (Lo)
01	02	00	00	00	10

Response message

DA	FC	BC	DATA	
01	02	02	FE	DC

- DA: Device Address-0x01
- FC: Function Code-0x02:read DI
- SA(Hi): Start Address(Hi byte)-0x00
- SA(Lo): Start Address(Lo byte)-0x00
- NO(Hi): No. Of points(Hi byte)-0x00
- NO(Lo): No. Of points (Lo byte)-0x10
- BC: Byte Count-0x02

## 5. Application of Utility

### 5.1 Install Utility

Step 1 :

Download the PROFIBUS/Modbus gateway utility setup file from the CD-ROM disk following the path of “CD:\profibus\gateway\gw-7553\utilities\” or the web site

“[ftp://ftp.icpdas.com.tw/pub/cd/fieldbus\\_cd/profibus/gateway/gw-7553/utilities/](ftp://ftp.icpdas.com.tw/pub/cd/fieldbus_cd/profibus/gateway/gw-7553/utilities/)”

Step 2 :

Execute the Setup.exe file to install the PROFIBUS/Modbus Gateway Utility.

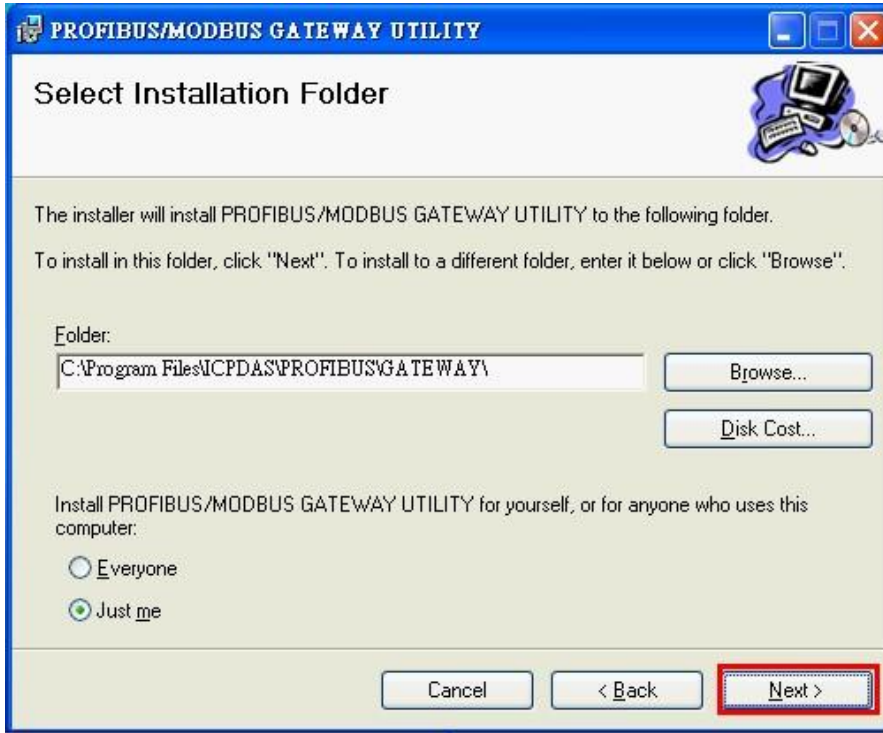

Figure 68 Install the utility

Step 3 :

Click the “Next” button to continue. If you want to change the installation destination, click “Browse” button to set the installation path.

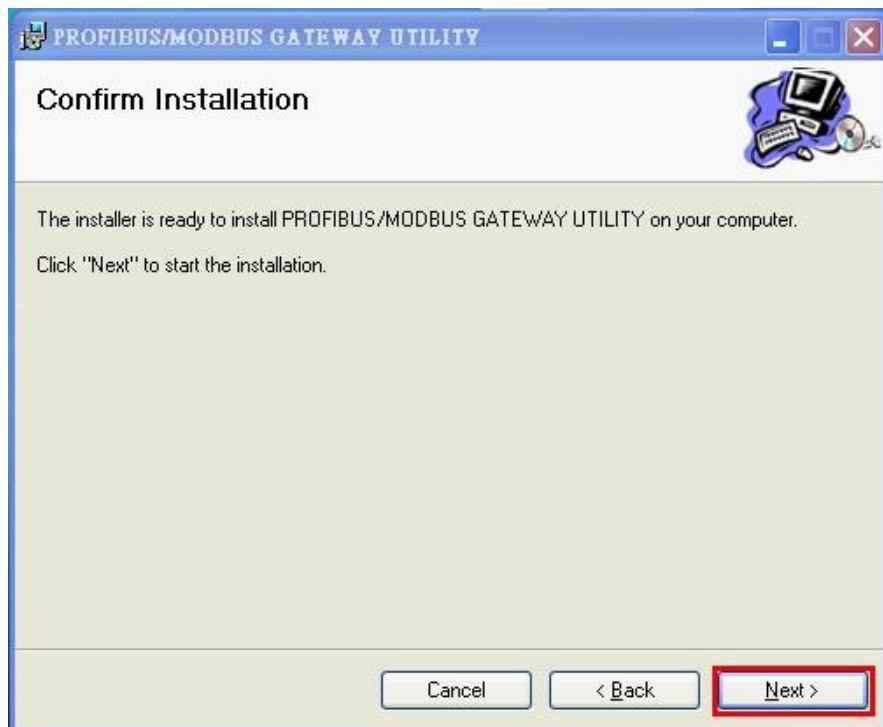



*Figure 69 Set the installation path*

Step 4 :

Click the “Next” button to confirm installation



*Figure 70 Confirm installation*

Step 5 :

Click the “Close” button to finish and exit the installation program

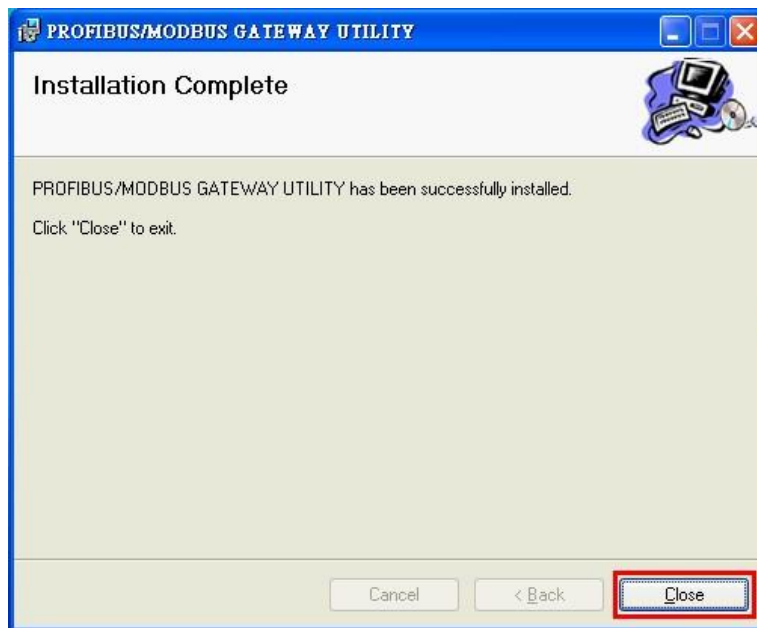

Figure 71 Installation complete

Step 6 :

After finishing the installation of the PROFIBUS/Modbus Gateway Utility, users can find the Utility as shown in the following screen shot.



Figure 72 The path of Utility

## 5.2 Utility introduction

By this utility, the user can understand the module address of PROFIBUS、Modbus and the GW-7553. The utility also support users set safe value and network setting easily. It introduces main window of the utility first as shown in *Figure 73*.

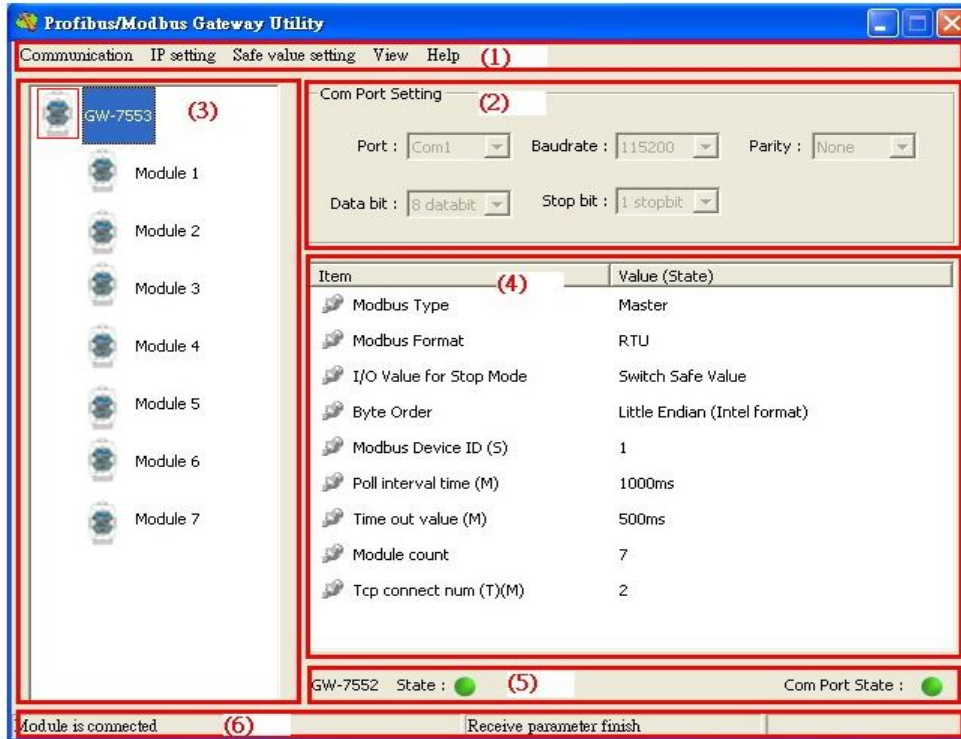

*Figure 73 Main window of the utility*

Main window of the utility has 6 parts, they are (1)Menu、(2)COM Port settings、(3)Module state、(4)Module parameters、(5)Connection status of GW-7553 and COM Port、(6) Status bar, as shown in the below.

### 5.2.1 Menu :

1. Communication =>

- a. Connect : Open COM Port and connect with the GW-7553
- b. Disconnect : Close COM Port and disconnect with the GW-7553
- c. Exit : Exit from the utility

2. IP Setting =>

- a. New Setting : Open a new IP setting.
- b. Load from file : Load a IP setting from the file.

- c. Load from device : Load a IP setting from the GW-7553.
3. Safe Value Setting =>
- a. New Setting : Open a new safe value setting.
  - b. Load from file : Load a safe value setting from the file.
  - c. Load from device : Load a safe value setting from the GW-7553.
4. View =>
- a. Space configuration in device : Display memory address configuration of select module in the GW-7553.
  - b. Space configuration in PROFIBUS : Display memory address configuration of select module in PROFIBUS Master station.
  - c. Space configuration in Modbus : Display memory address configuration of select module in the Modbus.
5. Help =>
- a. Get Firmware Version From Module : Show firmware version of the GW-7553.
  - b. About Utility : Show about version of the utility.

### **5.2.2 COM Port settings :**

- 1. Port: COM1~COM8
- 2. Baud rate: 2400/4800/9600/19200/38400/57600/115200
- 3. Parity: None/Odd/Even
- 4. Data bit: 8 data bit
- 5. Stop bit: 1 stop bit

### **5.2.3 Module state :**

It can display the number of modules in the GW-7553 and display module parameters in the window of the module parameter by click the module's icon.

### **5.2.4 Module parameters :**

Display module parameters of the GW-7553.

### **5.2.5 Connection status of device and COM Port :**

Module state : Display connection status between the utility and the GW-7553.

The green color means connected and the red color means disconnected.

COM Port state : Display state of the PC's COM Port. The green color means

COM Port is open and the red color means COM Port is close.

### 5.2.6 Status bar :

Display messages about COM Port connection 、 the GW-7553 connection and the progress of data transmission.

## 5.3 Memory address configuration of the module

There are 3 kinds of memory address configuration. They are (1)Space configuration in device 、 (2) Space configuration in PROFIBUS 、 (3)Space configuration in Modbus, as shown in *Figure 74*.

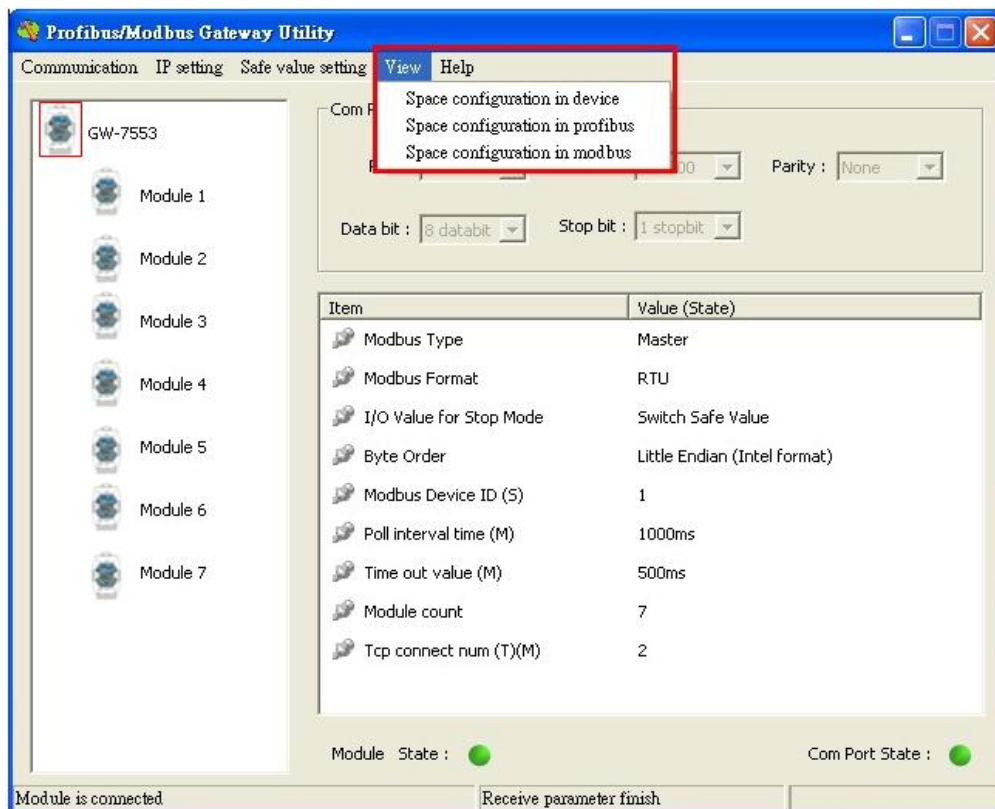

Figure 74 The menu of space configuration

### 5.3.1 Space configuration in device :

The user can select check box of the module to show memory address configuration of DI/DO/AI/AO in the GW-7553, as shown in *Figure 75*.

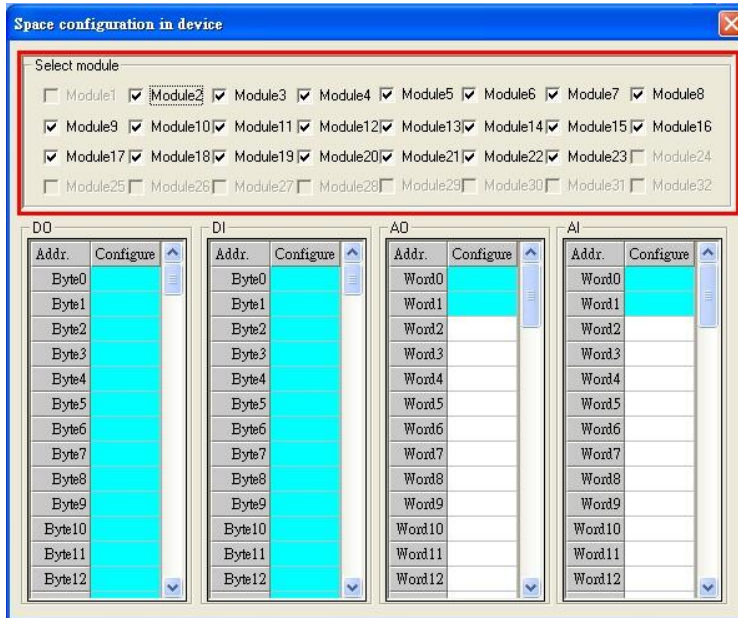

Figure 75 Space configuration in device

### 5.3.2 Space configuration in PROFIBUS :

The user can select check box of the module to show memory address configuration of I/O data area in the PROFIBUS Master station, as shown in **Figure 76**.

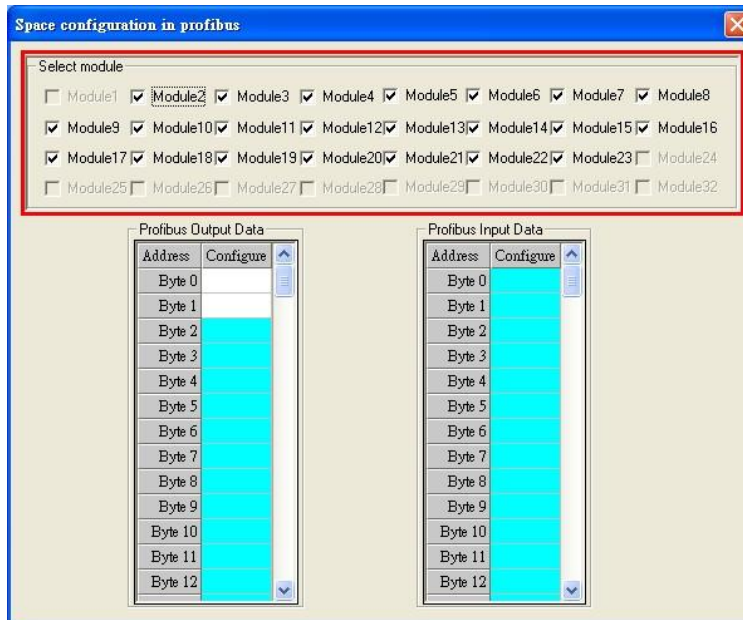

Figure 76 Space configuration in PROFIBUS

### 5.3.3 Space configuration in Modbus :

The window of "Space Configuration in Modbus" divided into 3 parts to explain, as shown in **Figure 77**.

(1) Select module:

The user can select check box of the module to show memory address configuration of DI/DO/AI/AO in Modbus network.

(2) Display interface:

The user can click “Write Output” button to show DO/AO memory address configuration of output modules in Modbus network, click “Read Input” button to show DI/AI memory address configuration of input modules in Modbus network, click “Read Output” button to show DO/AO memory address configuration of input modules in Modbus network.

(3) Color display:

The user can discriminate states of Modbus address configuration by different color. White means the address is not used. Light blue means the address was configured by a module. Mazarine means the address was configured by many modules, but Modbus ID is not repeat in these modules. Red means the address was configured by many modules and Modbus ID is repeat in these modules. The data may be read and written by different modules at this time, it may make the data transmit and device control error easy because address configuration and Modbus ID overlap.

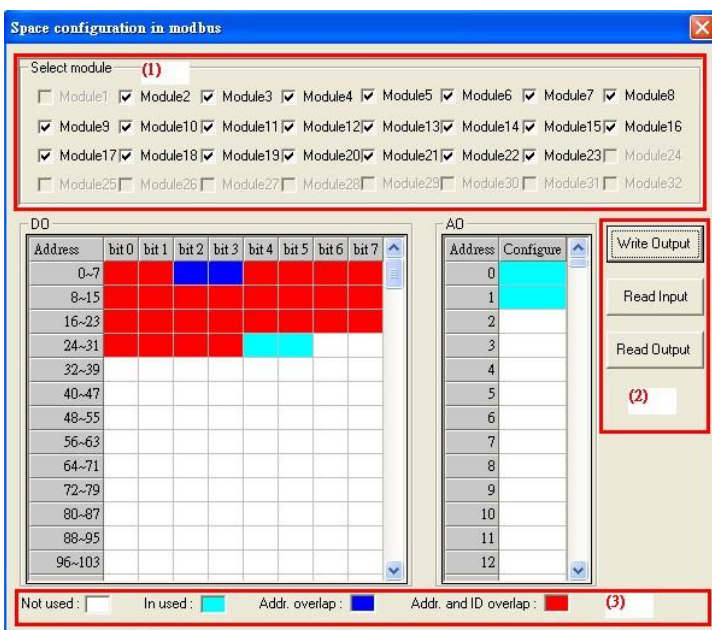
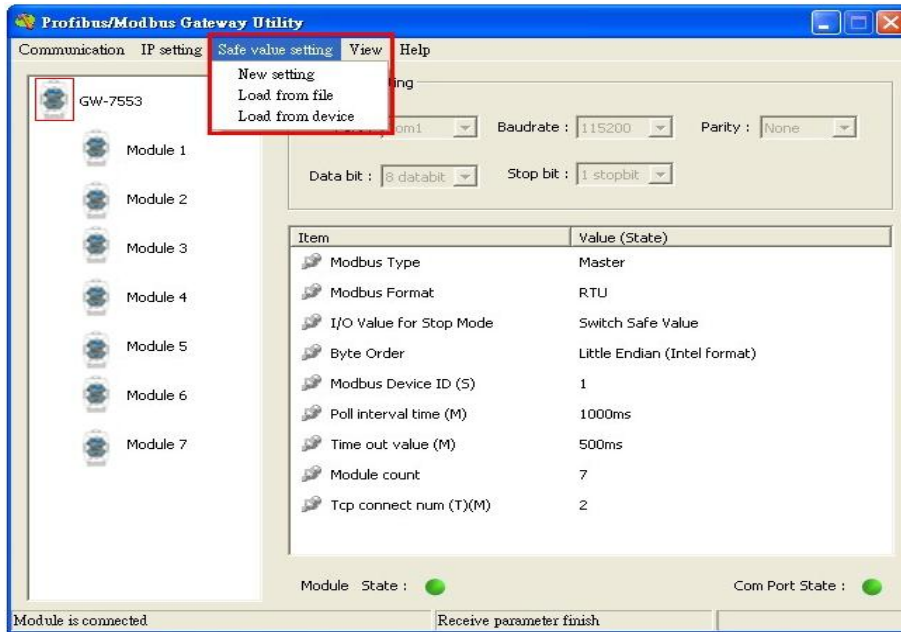

Figure 77 Space configuration in Modbus

## 5.4 Safe value setting

There are 3 kinds of safe value setting. They are (1) Open a new setting、(2)Load from file、(3)Load from device, as shown in *Figure 78*.



*Figure 78* The menu of safe value setting

The window of “Safe Value Setting” divided into 6 parts to explain, as shown in *Figure 79*.

### (1) Select module:

The user can select check box of the module to know memory address configuration of the module for set safe value of the module.

### (2) DI/O table:

The user can double click left button of mouse at the value of DI/DO to change the value from “H” to “L” or “L” to “H”.

### (3) All DI/O setting:

The user can click “All set to H” button to set all of DI/DO to “H” and click “All set to L” button to set all of DI/DO to “L”.

### (4) AI/O table:

The user can double click left button of mouse at the value of AI/AO to change the value into 0x0000~0xFFFF.

### (5) All AI/O setting:

The user can click “All set to F” button to set all of AI/AO to “0xFFFF” and click



“All set to 0” button to set all of AI/AO to “0x0000”.

### (6) Display and Save interface

The user can click “Output” button to show safe value setting of DO/AO, click “Input” button to show safe value setting of DI/AI, click “Save to File” button to open “save file dialog” to save safe value setting for backup, click “Save to Device” button to save safe value setting to EEPROM of the GW-7553.

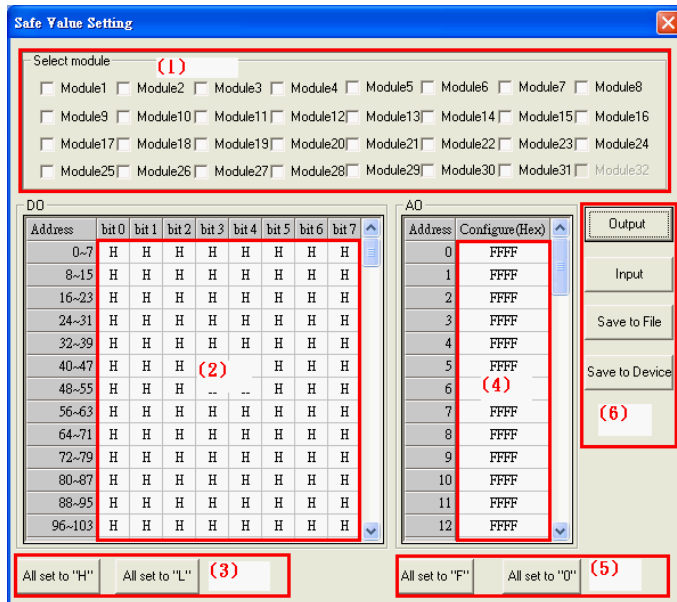

Figure 79 Safe value setting

## 5.5 IP setting

There are 3 kinds of IP setting. They are (1) Open a new setting 、(2)Load from file 、(3)Load from device, as shown in **Figure 80**.

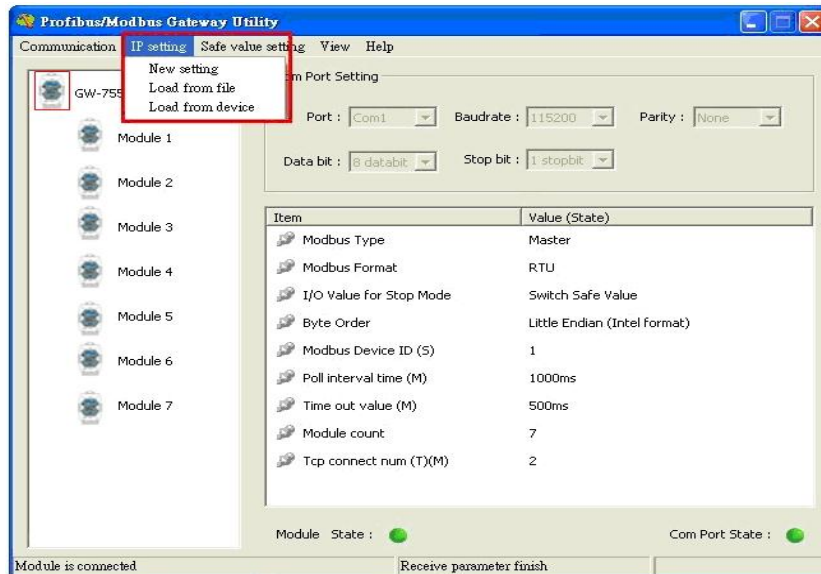

Figure 80 The menu of IP setting

The window of “IP Setting” divided into 3 parts to explain, as shown in *Figure 81*.

(1) Local IP Setting:

The user can set local IP setting of GW-7553 in this part.

(2) Remote IP Setting:

The user can set IP address, time out value and reconnecting time of the Modbus TCP Slave in this part. When GW-7553 acts as a Modbus TCP Master, these settings are effective. GW-7553 can connect Modbus TCP Slave devices by these IP settings and the maximum of Modbus TCP Slave device is 8.

(3) Save interface

The user can click “Save to File” button to open “save file dialog” to save IP setting for backup, click “Save to Device” button to save IP setting to EEPROM of the GW-7553.

Note:

If IP setting is ok, user needs to restart GW-7553 to read new IP setting value.

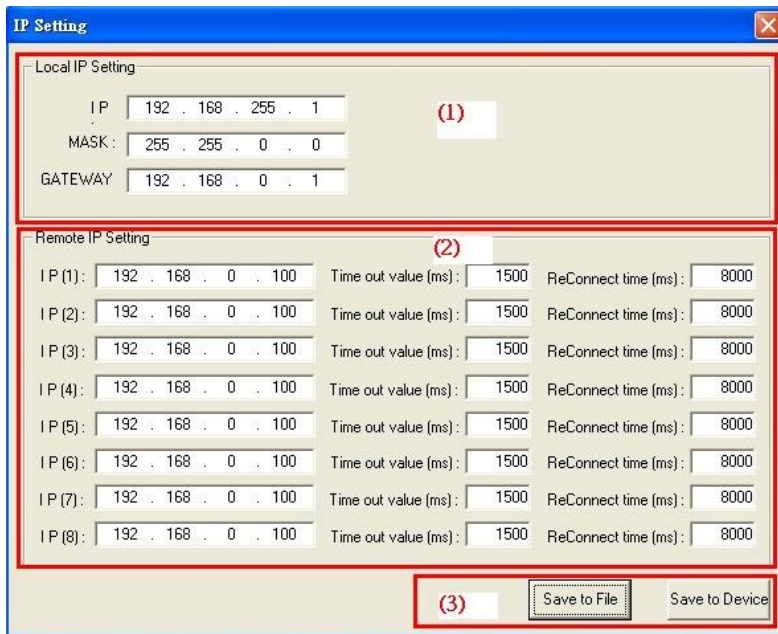

Figure 81 IP setting

## 5.6 Establish connection with GW-7553

The connection of Utility and GW-7553 is shown in *Figure 82*. Please follow the steps to establish connection.

Step 1:

Wire COM Port of PC to RS-232 port of GW-7553.

Step 2:

Connect PROFIBUS cable between PROFIBUS Master station and GW-7553 and enter data exchange mode (please refer step 1~6 of section 4.8 PROFIBUS and Modbus data exchange demo for detail). The RUN LED of GW-7553 is going to light at this time.

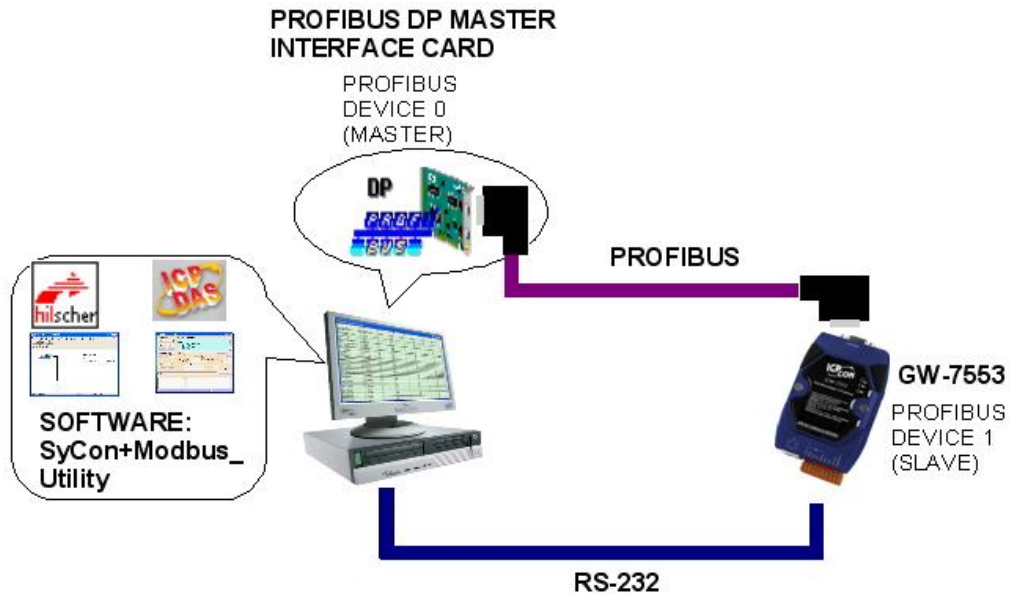

Figure 82 The connection of Utility and GW-7553

Step 3:

Set bit 2 of byte 1 to High in output data area of the PROFIBUS Master station (set the GW-7553 to setting mode; please refer section 4.6.2 Output data area and communication command) or turn the switch on the back of the GW-7553 to setting mode (please refer section 2.6 Normal/Setting DIP switch).

Step 4:

Open Utility.exe on PC.



Figure 83 Open Utility

Step 5:

Set COM Port communication setting of Utility (please refer section 5.2.2 COM Port settings) the same as COM Port setting of GW-7553(please refer section 4.3 The Configuration of the common parameters)

Step 6:

Click “Communication=>Connect” button in menu.

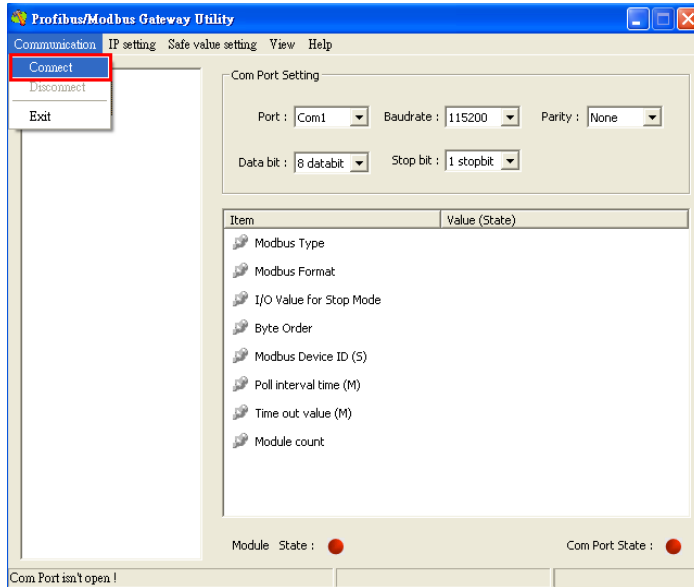

Figure 84 Communication menu

Step 7:

Module state shows green in the Utility now, it means the connection is complete.

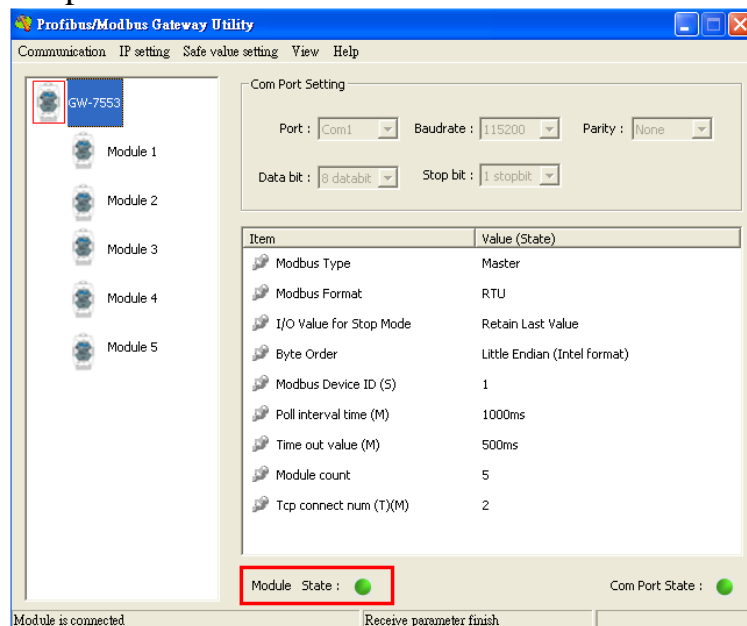
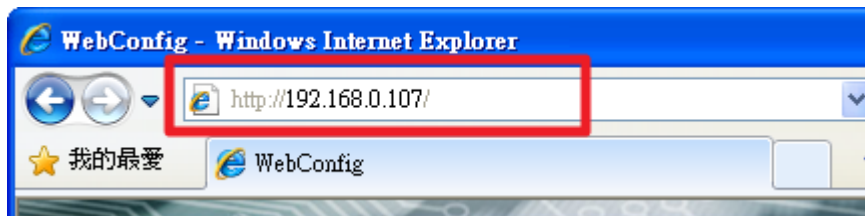

Figure 85 Display connection state

## 6. Configuration with Web Browser

### 6.1 Connecting to Web Server

Open web browser (ex. IE) and enter the IP address of the GW-7553 module in the Address field and press “**Enter**” to connect to GW-7553 module, as shown in *Figure 86*



*Figure 86 Connecting to Web Server*

User can do the following steps to find the IP address of GW-7553:

Step 1: Open MiniOS7 Utility

1. The utility is on the web site in the following directory:

[http://ftp.icpdas.com/pub/cd/8000cd/napdos/minios7/utility/minios7\\_utility/](http://ftp.icpdas.com/pub/cd/8000cd/napdos/minios7/utility/minios7_utility/)

2. Choose “Connection→Search” or “F12”, as shown in *Figure 87*.

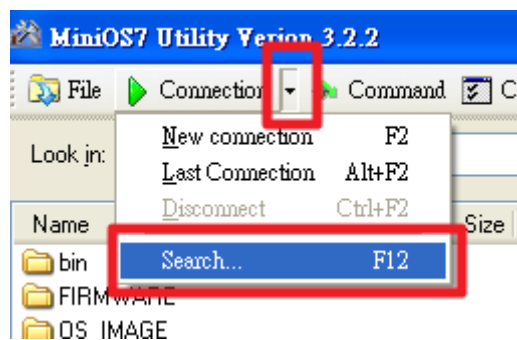

*Figure 87 Search IP*

Step 2: User can find the IP address of GW-7553, as shown in *Figure 88*

Type	IP/Port	Name	Alias
TCP BroadCast	192.168.0.240	tGW-715	Tiny
TCP BroadCast	192.168.255.200	tGW-715	Tiny
TCP BroadCast	192.168.255.201	tGW-715	Tiny
TCP BroadCast	192.168.111.111	PDS-782	
TCP BroadCast	192.168.0.107	GW-7553	GW-7553

Figure 88 IP address

## 6.2 Web Configuration—Function menu



The left side is the function menu and the other is the setup page in the first page.

Function menu:

- Login
- User Account
- IP Setting
- Safe Value Setting
- Communication Log
- Information

Reboot

The “Reboot” button can provide the user to restart the GW-7553, when user login successfully.

## 6.3 Web Configuration—Setup page

### A. Login

The user login and logout interface, as shown in *Figure 89*

The figure displays two side-by-side web interface panels. The left panel, titled 'Login', contains a red error message 'You are not logged yet!!'. Below the message is a password input field with a hint '(0~9, A~Z, a~z)' and an 'Enter' button. The right panel, titled 'Logout', contains a blue message 'You had logined already~' and a red message 'You can click button to Logout !!' with a 'Logout' button below it.

*Figure 89 Login*

#### Note:

- The user can turn the switch on the back of the GW-7553 to setting mode (Please refer to section 2.6) , and then user can login by using the default password of GW-7553.
- The default password of GW-7553 is “icpdas”
- The idle time of web server is 5 minutes. If web server is idle more than 5 minutes, web server will logout automatically.



## B. User Account

The user can change password in this page, as shown in *Figure 90*.

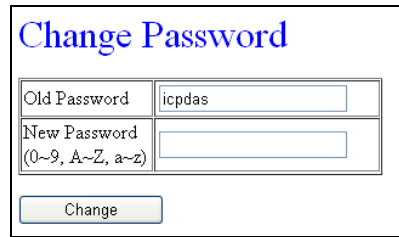

The image shows a web form titled "Change Password". It contains two input fields: "Old Password" with the value "icpdas" and "New Password" with a placeholder "(0~9, A~Z, a~z)". Below the fields is a "Change" button.

*Figure 90 User Account*

## C. IP Setting

The user can set IP setting in this page, as shown in *Figure 91*, if IP setting is ok, user needs to restart GW-7553 to read new IP setting value

- (1) New Setting : Open a new IP setting
- (2) Load From Device : Load the IP setting from GW-7553
- (3) Local IP Setting : The user can set local IP setting of GW-7553 in this part.
- (4) Remote IP Setting : The user can set IP address, time out value and reconnecting time of the Modbus TCP Slave in this part. When GW-7553 acts as a Modbus TCP Master, these settings are effective. GW-7553 can connect Modbus TCP Slave devices by these IP settings and the maximum of Modbus TCP Slave device is 8.
- (5) Save to Device : Save the IP setting to EEPROM of GW-7553

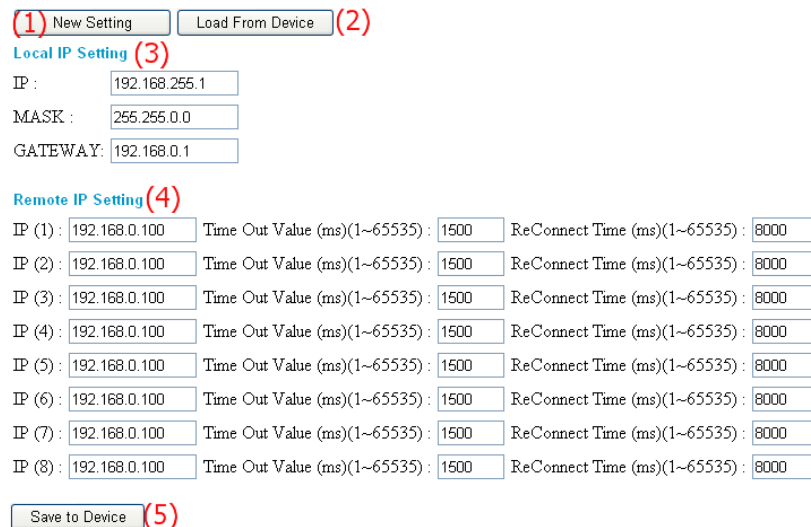

The image shows a web form for IP settings. It includes buttons for "New Setting" (1) and "Load From Device" (2). Below are sections for "Local IP Setting" (3) and "Remote IP Setting" (4). The "Local IP Setting" section has input fields for IP (192.168.255.1), MASK (255.255.0.0), and GATEWAY (192.168.0.1). The "Remote IP Setting" section has a table with 8 rows, each with input fields for IP, Time Out Value (ms)(1~65535), and ReConnect Time (ms)(1~65535). The "Save to Device" button (5) is at the bottom.

*Figure 91 IP Setting*

## D. Safe Value Setting

The user can set safe value setting in this page, as shown in *Figure 92*. User select the module and press “Enter” to show the safe value setting of this module and it will save the safe value setting to EEPROM of GW-7553 when user press “Save to Device”.

The figure shows two screenshots of a web-based configuration interface for setting safe values in a device. The top screenshot is for Module 2, and the bottom screenshot is for Module 5.

**Module 2 => DO Setting**

Module : 02 [Enter]

Select Module and Press Enter Button !!

Load From Device

Data Length => 2 bytes

Byte	Value(Hex)
0~1	FF.FF

All Set to HIGH    All Set to LOW

Save to Device

**Module 5 => AI Setting**

Module : 05 [Enter]

Select Module and Press Enter Button !!

Load From Device

Data Length => 12 words

Word	Value(Hex)
0~7	FFFF.FFFF.FFFF.FFFF.FFFF.FFFF.FFFF.FFFF
8~11	FFFF.FFFF.FFFF.FFFF

All Set to FFFF    All Set to 0000

Save to Device

*Figure 92 Safe Value Setting*

## E. Communication Log

The user can monitor communication between GW-7553 and Modbus devices

in this page, as shown in *Figure 93*.

## Communication Log

ModBus RTU => Master

[NO.]	[Time (ms)]	[Type]	[Frame]
[0000000025]	[0000796871]	[RDI]	Send:[ 01 02 00 00 00 10 79 C6 ]
[0000000025]	[0000797373]	[RDI]	Response Message Timeout
[0000000026]	[0000797380]	[RDI]	Send:[ 01 02 00 00 00 10 79 C6 ]
[0000000026]	[0000797883]	[RDI]	Response Message Timeout
[0000000027]	[0000797897]	[RDI]	Send:[ 01 02 00 00 00 10 79 C6 ]
[0000000027]	[0000798400]	[RDI]	Response Message Timeout
[0000000028]	[0000798407]	[RDI]	Send:[ 01 02 00 00 00 10 79 C6 ]
[0000000028]	[0000798910]	[RDI]	Response Message Timeout
[0000000029]	[0000798912]	[RDI]	Send:[ 01 02 00 00 00 10 79 C6 ]
[0000000029]	[0000799416]	[RDI]	Response Message Timeout
[0000000030]	[0000799418]	[RDI]	Send:[ 01 02 00 00 00 10 79 C6 ]
[0000000030]	[0000799921]	[RDI]	Response Message Timeout
[0000000031]	[0000799923]	[RDI]	Send:[ 01 02 00 00 00 10 79 C6 ]
[0000000031]	[0000800427]	[RDI]	Response Message Timeout
[0000000032]	[0000800640]	[RDI]	Send:[ 01 02 00 00 00 10 79 C6 ]
[0000000032]	[0000801145]	[RDI]	Response Message Timeout
[0000000033]	[0000801153]	[RDI]	Send:[ 01 02 00 00 00 10 79 C6 ]
[0000000033]	[0000801657]	[RDI]	Response Message Timeout
[0000000034]	[0000801660]	[RDI]	Send:[ 01 02 00 00 00 10 79 C6 ]
[0000000034]	[0000802165]	[RDI]	Response Message Timeout
[0000000035]	[0000802168]	[RDI]	Send:[ 01 02 00 00 00 10 79 C6 ]

Clear      Update

*Figure 93 Communication Log*

## F. Information

Information is shown in *Figure 94*. This page has 4 parts, they are (1)PROFIBUS INFO、(2)MODULE LIST、(3)DIAGNOSTIC INFO、(4)DEVICE INFO, as shown in the below.

PROFIBUS INFO :	PROFIBUS Status	Enter
<u>MODULE LIST</u>		
<u>DIAGNOSTIC INFO</u>		
<u>DEVICE INFO</u>		

*Figure 94 Information*

### (1) PROFIBUS INFO :

- a. PROFIBUS Status : This page shows PROFIBUS mode、PROFIBUS address and PROFIBUS baudrate.

## PROFIBUS STATUS

PROFIBUS Mode :

PROFIBUS Address :

PROFIBUS Baudrate :

[Back~](#)

- b. Common Parameters : This page shows common parameters of PROFIBUS.

## COMMON PARAMETERS

Module Count :

ModBus Type :

ModBus Format :

I/O Safe Mode :

Byte Order :

Output Data Mode :

ModBus Device ID(S) :

ModBus Polling Interval(ms)(M) :

Query Timeout Value(ms)(M) :

TCP Connect Num(T)(M) :

Communication Setting :

[Back~](#)

- c. Module Parameters : This page shows the module parameters of each module.

## MODULE PARAMETERS

Module :

Select Module and Press Enter Button !!

### Module 2

Module Type :   
ModBus Slave Device ID :   
ModBus start addr.(M) :   
NO. of Relay/Coil(M) :   
Tcp connect index(T)(M) :

[Back~](#)

### (2) MODULE LIST :

When PROFIBUS state is online, this page will shows all selected module of GW-7553, as shown in **Figure 95**.

### MODULE LIST

Module	Name
1	System setting
2	Output Relay/Coil--2 byte
3	Input Relay/Coil--2 byte
4	Output Register--1 word
5	Input Register--12 word

[Back~](#)

*Figure 95 Module List*

### (3) DIAGNOSTIC INFO :

When PROFIBUS state is online, this page will shows the diagnostic messages of GW-7553, as shown in **Figure 96**.

## DIAGNOSTIC INFO

Diag Data	Message	Description
05 A0 03 00 FE	Module 3 Error !	Response Message Timeout
05 A0 05 00 FE	Module 5 Error !	Response Message Timeout

[Back~](#)

*Figure 96 Diagnostic info*

### (4) DEVICE INFO :

This page shows the device information of GW-7553, as shown in *Figure 97*.

## DEVICE INFORMATION

Firmware Version :	<input type="text" value="V30"/>
Current IP :	<input type="text" value="192.168.0.107"/>
Subnet Mask :	<input type="text" value="255.255.0.0"/>
Gateway:	<input type="text" value="192.168.0.254"/>
Mac Address :	<input type="text" value="00:0D:E0:D0:4A:35"/>

[Back~](#)

*Figure 97 Device info*

## 7. Troubleshooting

The troubleshooting list can help users to resolve the problems when using the GW-7553. If the problem still can't be solved, please contact with technical staff of ICP DAS.

Table 23 Errors and solutions

Item	Trouble state	Solution
1	'PWR' LED indication of the GW-7553 is always turned off	The power supply of GW-7553 has some problems. Please check the wire connection of the power and the voltage is between 10~30V <sub>DC</sub> .
2	'ERR' LED indication of the GW-7553 is always turned on	That means the GW-7553 isn't connecting to the PROFIBUS Master station. Please check the wire connection and the PROFIBUS Master station. The configuration and address of GW-7553 in the PROFIBUS Master station are not correct.
3	'ERR' LED indication of the GW-7553 is flashing fast	It means the GW-7553 is in setting mode and connects with Utility. Please close Utility and set the GW-7553 to operation mode (please refer section 2.6 Normal/Setting DIP switch and section 4.6.2 Output data area and communication command).
4	'ERR' LED indication of the GW-7553 is flashing slow	It means the GW-7553 has diagnostic messages. Please check diagnostic messages in the PROFIBUS Master station.
5	PROFIBUS Master station can not communicate with the Modbus device, when "RUN LED" of the GW-7553 is light and "ERR LED" of the GW-7553 is dark.	<ol style="list-style-type: none"> <li>a. Please confirm the GW-7553 is working in operation mode and avoid clearing diagnostic message by communication command (please refer section 2.6 Normal/Setting DIP switch and section 4.6.2 Output data area and communication command).</li> <li>b. Please confirm the connection between the GW-7553 and Modbus device.</li> <li>c. Please confirm COM Port setting (please refer section 4.3 The Configuration of the common parameters) or IP setting (please refer section 5.5 IP setting) of the GW-7553 the same as the Modbus device.</li> <li>d. Please confirm module ID of the GW-7553 (please refer section 4.3 The Configuration of the common parameters and section 4.4 The Configuration of the modules) the same as Modbus address of Modbus device.</li> <li>e. Please confirm Setting of Start Address and NO. of Relay/Coil is correct (please refer section 4.4 The Configuration of the modules).</li> <li>f. Please confirm the output data put in correct address and have changed value of byte 0 to trigger the output command, when output data can not send to Modbus device in output data area of PROFIBUS Master (please refer section 4.6.2 Output data area and communication command).</li> </ol>

## 8. Dimensions

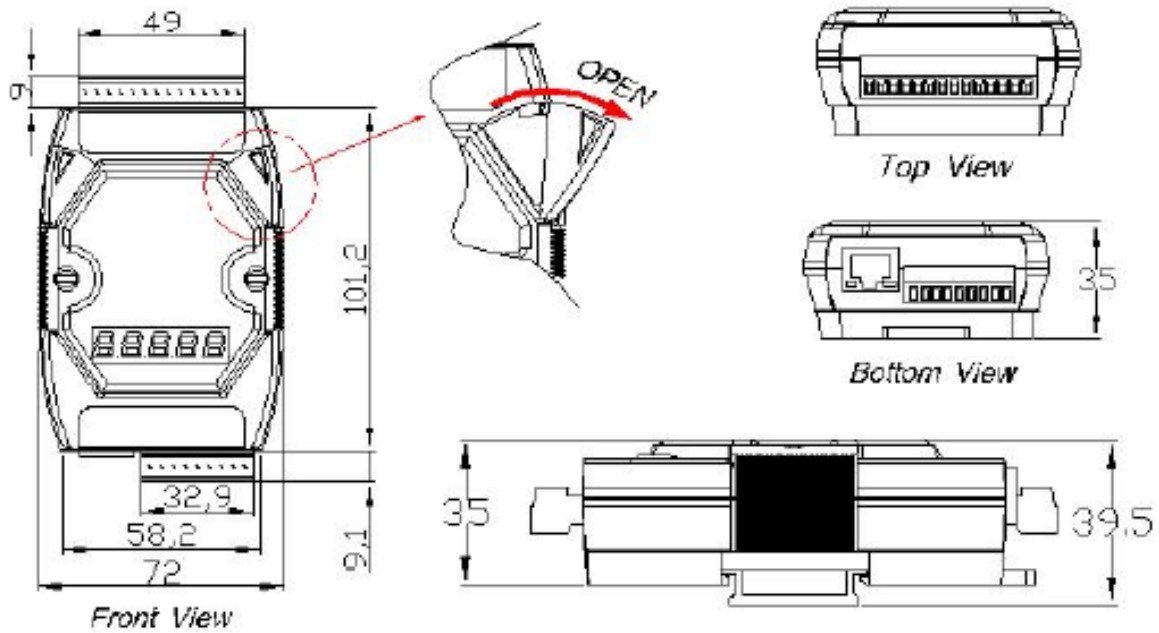

DIN-RAIL MOUNTING  
BRACKET

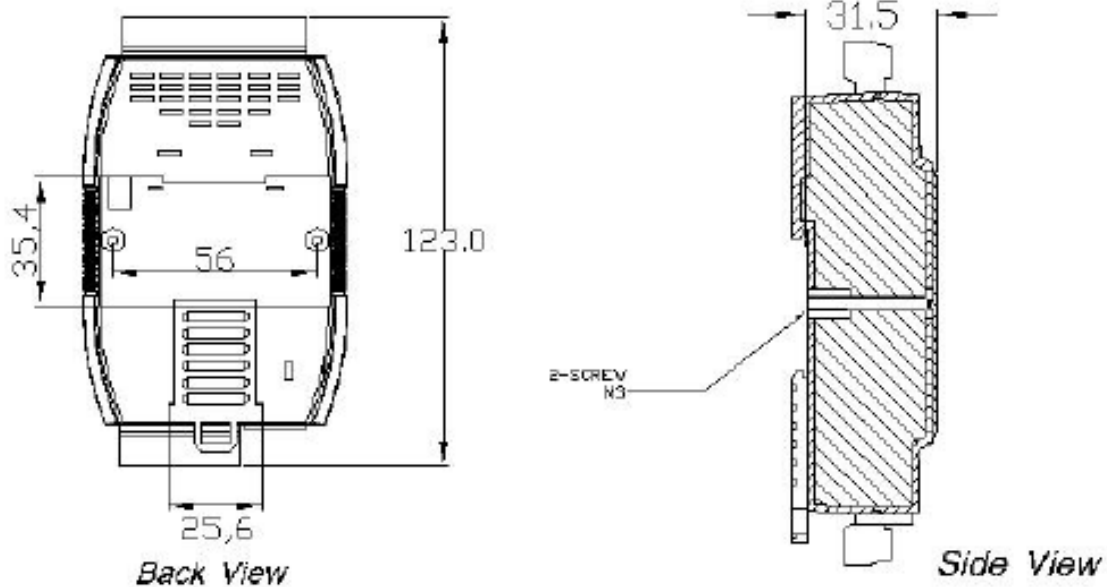

Unit : mm



