



HRT-711

User' s Manual

Version 1.00

Revision History

Revision	Date	Description
1.00	2014/01/21	First revision

Preface

Warranty

All products manufactured by ICP DAS are under warranty regarding defective materials for a period of one year from the date of delivery to the original purchaser.

Warning

ICP DAS assumes no liability for damages resulting from the use of this product. ICP DAS reserves the right to change this manual at any time without notice. The information furnished by ICP DAS is believed to be accurate and reliable. However, no responsibility is assumed by ICP DAS for its use, nor for any infringements of patents or other rights of third parties resulting from its use.

Copyright

Copyright © 2013 by ICP DAS CO., LTD. All rights are reserved.

Trademark

Names are used for identification purposes only and may be registered trademarks of their respective companies

Table of Contents

SECTION 1- INTRODUCTION.....	7
1.1 FEATURES.....	7
1.2 SPECIFICATION.....	8
SECTION 2- HARDWARE.....	9
2.1 BLOCK DIAGRAM.....	9
2.2 PIN ASSIGNMENT.....	9
2.3 WIRING.....	10
2.3.1 RS-232.....	10
2.3.2 HART.....	11
2.3.3 Ethernet.....	13
2.4 LED INDICATORS.....	13
2.5 DIP SWITCH.....	13
2.6 JUMPERS.....	14
2.7 MOUNTING.....	15
SECTION 3- HART INTRODUCTION.....	16
3.1 ANALOG AND DIGITAL SIGNAL.....	16
3.2 TOPOLOGY.....	17
3.3 HART FRAME.....	18
SECTION 4- MODBUS COMMUNICATION.....	20
4.1 MODULE EXECUTION PROCESS.....	20
4.2 MODBUS / HART MAPPING TABLE.....	20
4.2.1 Input Data Area - User CMD Data.....	20
4.2.2 Input Data Area - Module State Data.....	20
4.2.3 Input Data Area - Default CMD 0 Data.....	21
4.2.4 Input Data Area - Default CMD 3 Normal Format Data.....	22
4.2.5 Input Data Area - Module Error Record Data.....	23
4.2.6 Input Data Area - Default CMD 0&3 Status Data.....	23
4.2.7 Input Data Area - User CMD Error Status.....	24
4.2.8 Input Data Area - Module Hardware Data.....	25
4.2.9 Input Data Area - Through Mode Data.....	25
4.2.10 Input Data Area - Default CMD 3 Simple Format Data.....	25
4.2.11 Output Data Area.....	26
4.3 THROUGH MODE.....	27
SECTION 5- UTILITY.....	28
5.1 .NET FRAMEWORK INSTALLATION.....	28
5.2 INSTALL HRT-711 UTILITY.....	29

5.3 INTRODUCTION OF UTILITY	32
5.4 CONFIGURATION OF ETHERNET	32
5.5 CONFIGURATION OF MODBUS TO HART	33
5.5.1 Traffic Light.....	34
5.5.2 Current Config Module Name	34
5.5.3 Connection Status	34
5.5.4 Connection Control	34
5.5.5 Tools.....	34
APPENDIX A HART COMMAND.....	47
COMMAND 0 : READ UNIQUE IDENTIFIER.....	47
COMMAND 1 : READ PRIMARY VARIABLE	47
COMMAND 2 : READ P.V. CURRENT AND PERCENTAGE OF RANGE.....	47
COMMAND 3 : READ DYNAMIC VARIABLES AND P.V. CURRENT	48
COMMAND 6 : WRITE POLLING ADDRESS	48
COMMAND 11 : READ UNIQUE IDENTIFIER ASSOCIATED WITH TAG	48
COMMAND 12 : READ MESSAGE	49
COMMAND 13 : READ TAG, DESCRIPTOR, DATE	49
COMMAND 14 : READ PRIMARY VARIABLE SENSOR INFORMATION	49
COMMAND 15 : READ PRIMARY VARIABLE OUTPUT INFORMATION	50
COMMAND 16 : READ FINAL ASSEMBLY NUMBER	50
COMMAND 17 : WRITE MESSAGE	50
COMMAND 18 : WRITE TAG, DESCRIPTOR, DATE.....	51
COMMAND 19 : WRITE FINAL ASSEMBLY NUMBER	51
APPENDIX B COMMAND FORMAT.....	52
THE SIMPLE FORMAT OF HART COMMAND.....	52
Command 1 : (Read Primary Variable).....	52
Command 2 : (Read P.V. Current and Percentage of Range).....	52
Command 3 : (Read Dynamic Variables and P.V. Current).....	52

Section 1- Introduction

Modbus and HART are two kinds of famous protocols and used wildly in the fields of factory and process automation. The HRT-711 module is a Modbus to HART gateway. By using this module, users can integrate their HART devices into Modbus network easily. The below figure 1 shows an application example for the HRT-711 module.

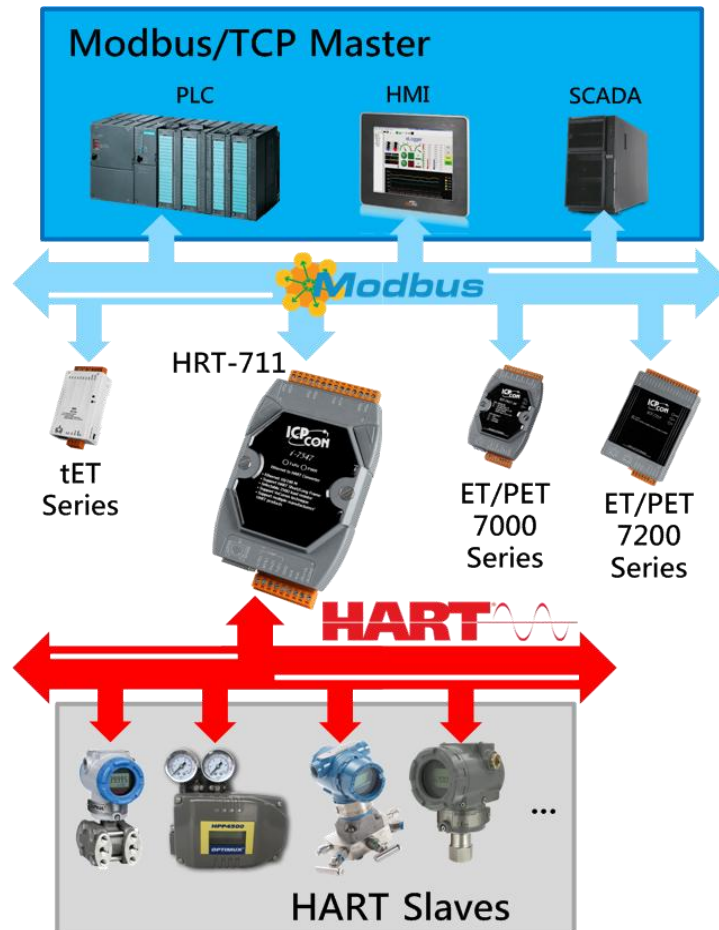

1.1 Features

- Support HART Short/Long frame
- Support HART Burst mode
- Allow two HART Masters
- Support Modbus/TCP Format
- Support Modbus Slave / HART Master Mode
- Support Firmware Update via Com Port
- Support On-line Replacement of HART Devices
- Support Acquire Long Frame Address Automatically
- Provide LED indicators
- Built-in Watchdog
- DIN-Rail or Wall Mounting

1.2 Specification

Item	Specification						
Com Port	RS-232(3 wire)						
	Screwed terminal block						
	Fixed baud rate 115200 bps						
HART	1 HART Modem						
	Screwed terminal block						
	Operates as a HART Master station and supports all HART commands						
	Support Short and Long Frame						
	Support Point to Point or Multi-drop						
	Max. 15 HART modules						
	Max. 100 user commands and 32 default commands						
Ethernet	1 x 10/100Base-TX Ethernet Controller						
	RJ-45						
	Auto Negotiation						
	Auto MDIX						
Power	+10 ~ +30 V _{DC}						
	Power reverse protection and Over-Voltage brown-out protection						
	Power Consumption : 2 W						
Module	Dimensions: 72 mm x 121 mm x 35 mm (W x L x H)						
	Operating temperature: -25 ~ 75 °C						
	Storage temperature: -30 ~ 85 °C						
	Humidity: 5 ~ 95% RH, non-condensing						
	3 x LED indicators						
	<table border="1"> <tr> <td>ETH LED</td> <td>Network Status</td> </tr> <tr> <td>HART LED</td> <td>HART Status</td> </tr> <tr> <td>ERR LED</td> <td>Error</td> </tr> </table>	ETH LED	Network Status	HART LED	HART Status	ERR LED	Error
	ETH LED	Network Status					
HART LED	HART Status						
ERR LED	Error						

Section 2- Hardware

2.1 Block Diagram

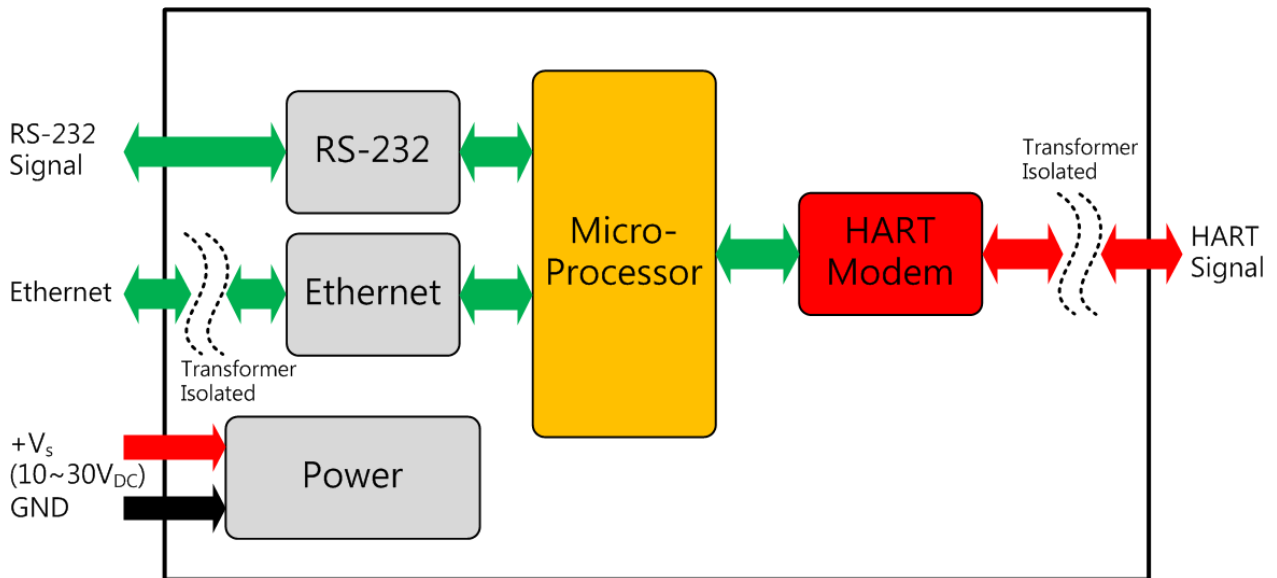

2.2 Pin Assignment

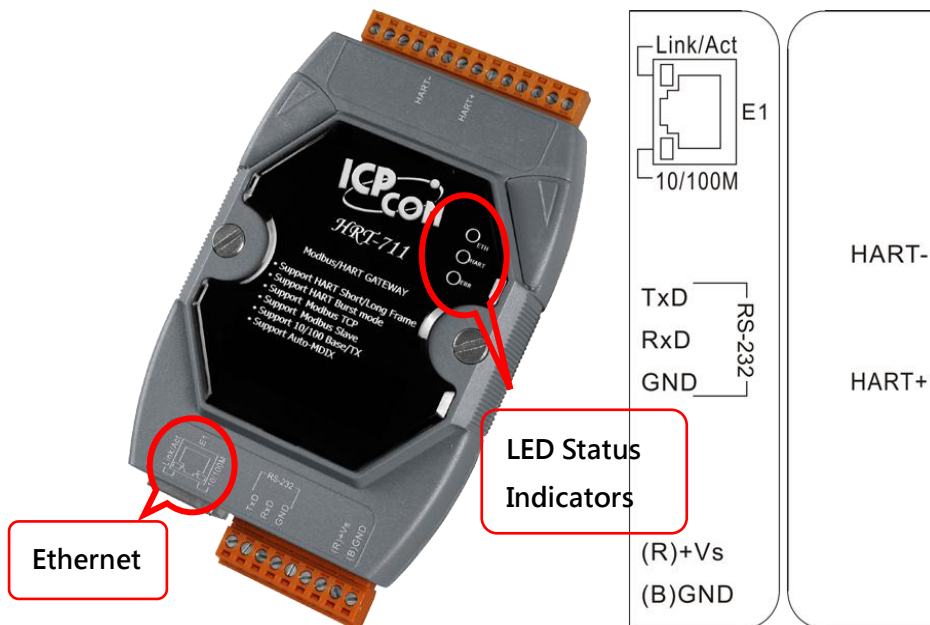

Pin Name	Group	Description
HART+	HART	Positive of HART
HART-		Negative of HART
+VS	Power Source	V+ of Power Supply(+10 ~ +30 VDC)
GND		GND of Power Supply
TXD	Configuration	Transmit Data of RS-232
RXD		Receive Data of RS-232
GND		GND of RS-232
E1	Modbus/TCP	Ethernet RJ45 connector for Modbus/TCP

2.3 Wiring

In this section, this user' s manual will introduce the wiring for each interface.

2.3.1 RS-232

The RS-232 port of HRT-711 uses a 3-wire communication interface. It needs a unique cable, CA-0910, to wire from screwed terminal block to D-Sub 9pin connector. Users can choose use CA-0910 for RS-232 wiring or directly connecting to D-Sub. 2.3.1.1 and 2.3.1.2 are the wiring for the RS-232 interface.

2.3.1.1 Without CA-0910

When users choose not to use CA-0910 for RS-232 wiring, user have to have a D-Sub 9pin connector to wire. The following figure is the wiring diagram for the wiring without CA-0910.

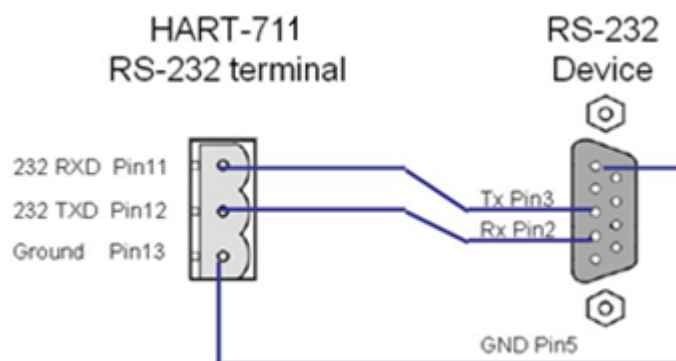

2.3.1.2 With CA-0910

It is recommended that users use CA-0910 for wiring the RS-232 port. The wiring of CA-0910 and HRT-711 is shown as below.

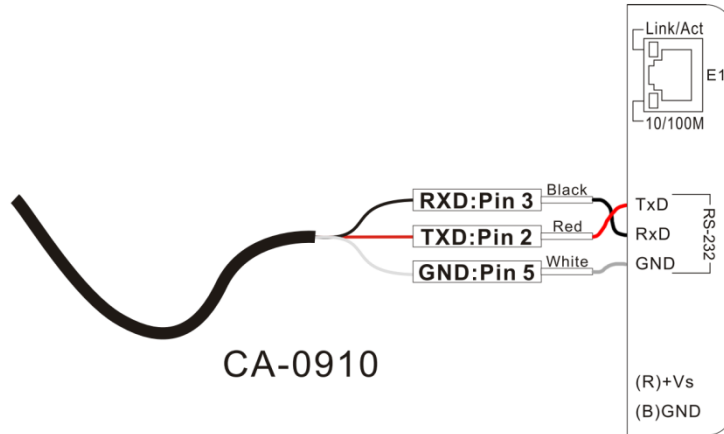

2.3.2 HART

The wiring of HART bus can be divided into two types. One is loop power (Passive Loop), and the other is external power (Active Loop). The following figures show the wiring for the HART bus.

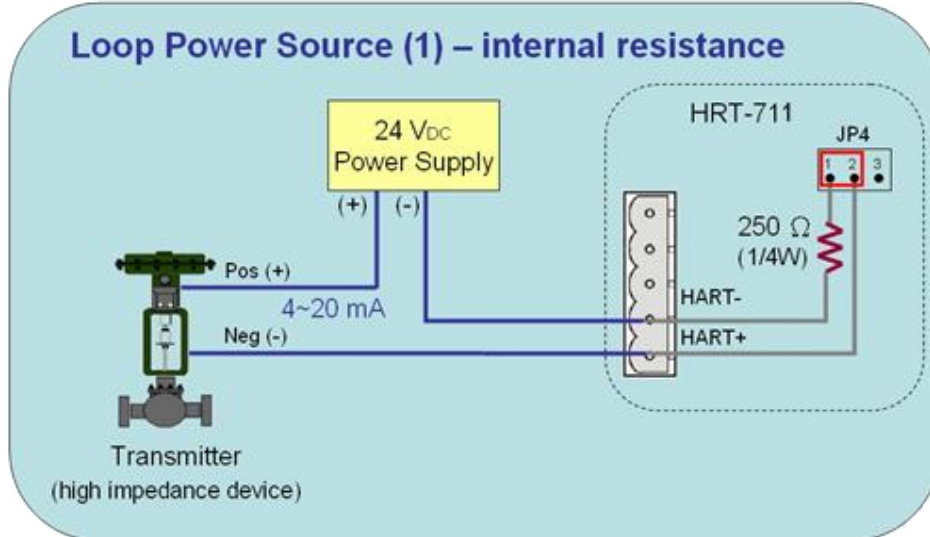

Loop Power Source (2) – external resistance

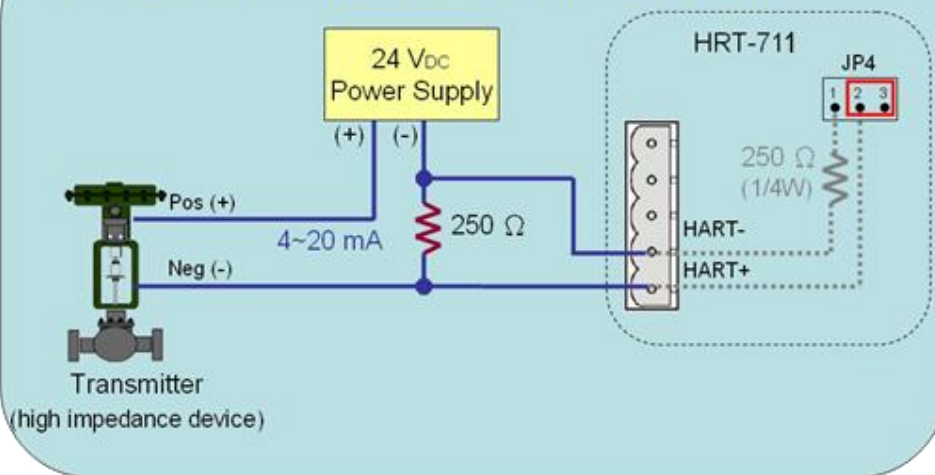

Loop Power Source (3) – external resistance

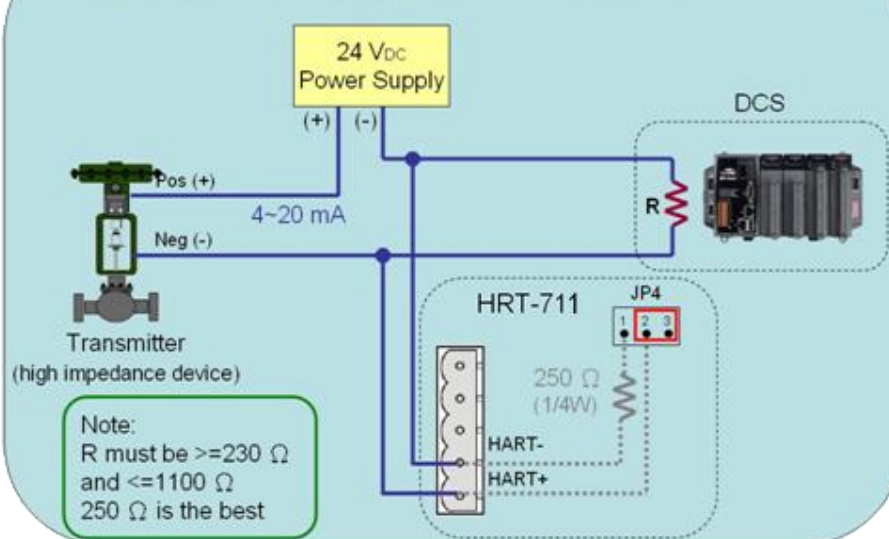

External Power Source – external resistance

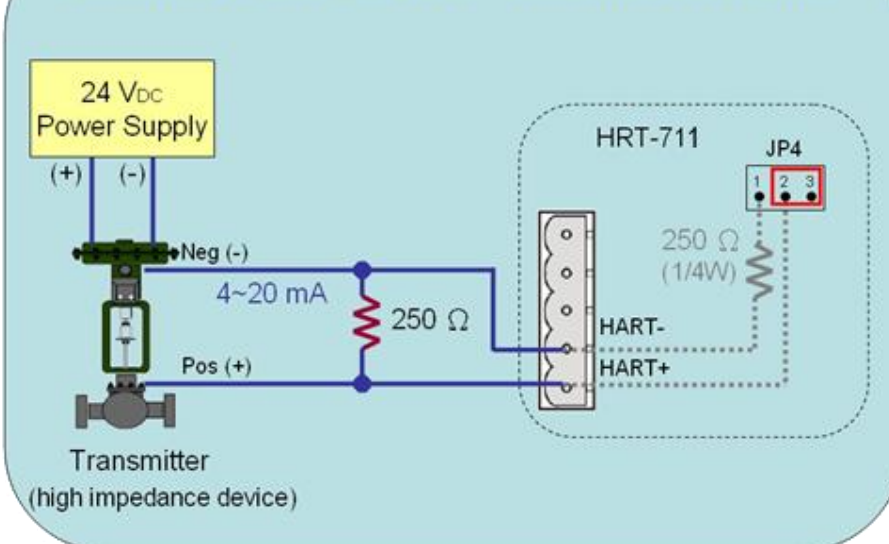

2.3.3 Ethernet

The wiring for Ethernet is directly connecting your RJ-45 Ethernet cable to the RJ-45 port on the HRT-711.

2.4 LED Indicators

The HRT-711 provides three LED indicators to indicate the module status. The descriptions are shown as follow.

LED	Status	Description
ETH	Blink	Blink every 0.2 second : Receiving Ethernet packet Blink every 3 second : The network function is normal
	Off	Ethernet Error
HART	Blink	Blink every 1 second : The HRT-711 is in the initialing procedure
		Blink every 0.5 second : The HRT-711 is handling the burst frame sent from HART device
	Solid	The HRT-711 is in the normal status
	Off	Firmware is not loaded
ERR	Blink	HART communication error
	Off	HART communication is good



2.5 DIP Switch

The DIP switch is used for switching the mode between Init and Normal. The switch is located in the back of the module. In the init side, the module can be configured through Utility. In the normal side, the module is a gateway between HART and Modbus/TCP protocol. Users have to power cycle the module when switch to different mode.

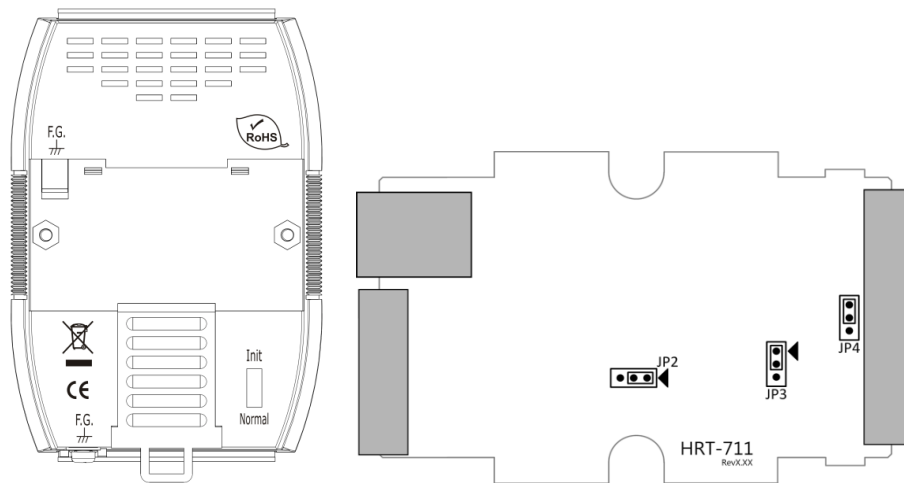

2.6 Jumpers

There are three jumpers for enabling/disabling function. The description for each jumper is shown as following table.

Jumper	Description
JP2	Enable/Disable hardware WDT. (Default setting is enable) NOTE: Please do not disable the hardware WDT.
JP3	For updating firmware. (Default setting is on 1 and 2) NOTE: Please do not switch to 2 and 3 when in normal operation.
JP4	The jumper can provide HART bus with 250 Ω (1/4 W) resistor. When the pin 1&2 of JP4 is closed, the resistor will connect to HART bus. When the pin 2&3 of JP4 is closed or JP4 without jumper connected, it will disconnect the resistor from HART bus. By default, the pin1&2 of JP4 is closed. Please refer to section 2.3.2 .

2.7 Mounting

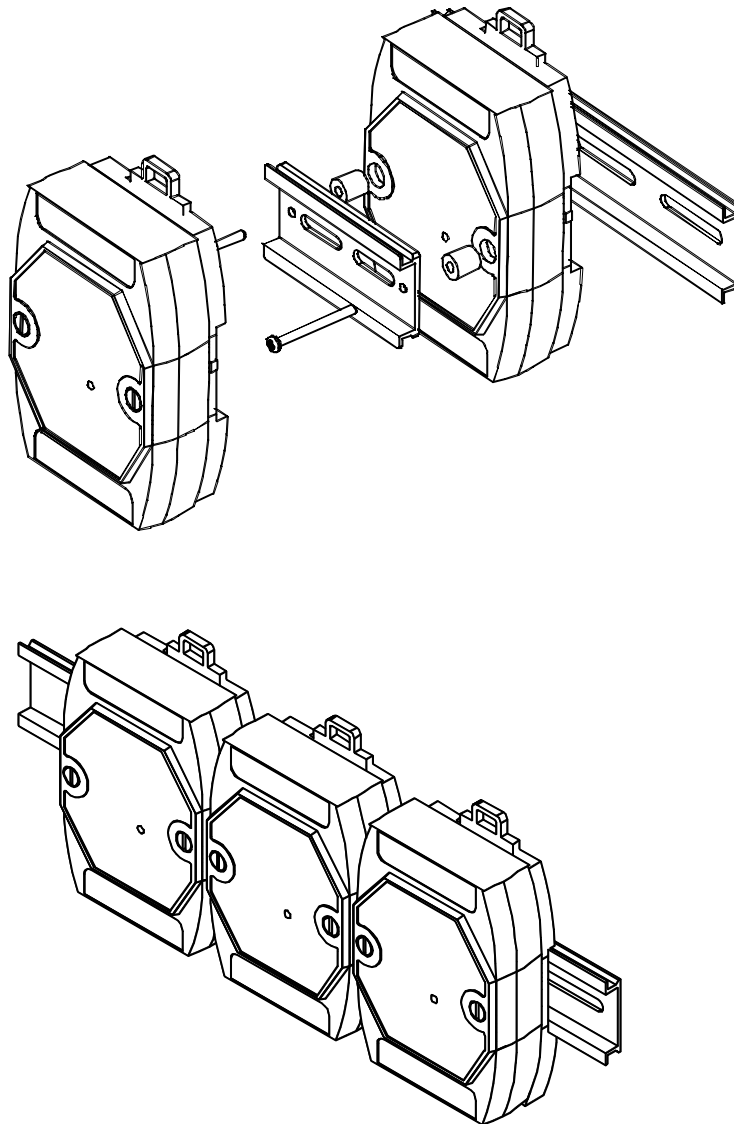

Section 3- HART Introduction

3.1 Analog and Digital Signal

The HART communication protocol is based on the Bell 202 telephone communication standard and operates using the frequency shift keying (FSK, Figure 14) principle. The digital signal is made up of two frequencies - 1,200 Hz and 2,200 Hz representing bits 1 and 0, respectively. Sine waves of these two frequencies are superimposed on the direct current (dc) analog signal cables to provide simultaneous analog and digital communications.

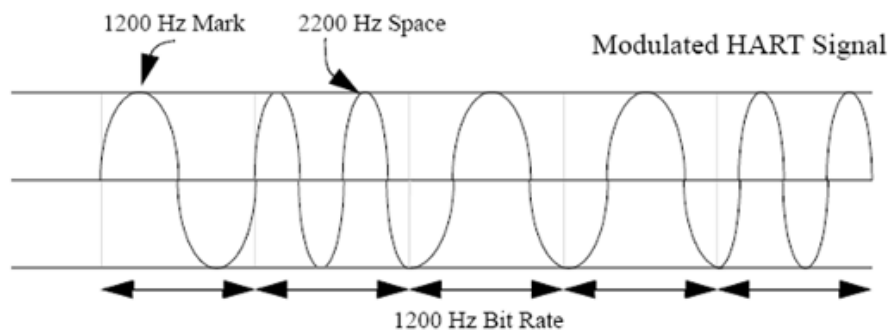

Frequency-Shift-Keying

1200 Hz : 1

2200 Hz : 0

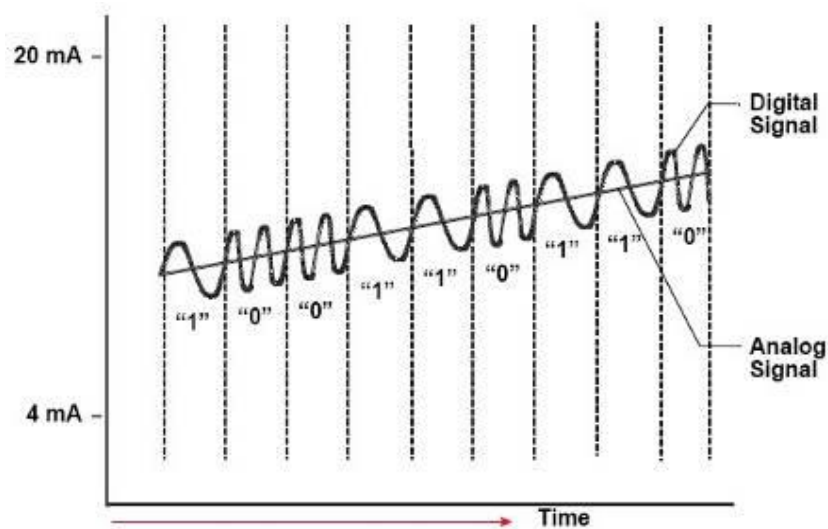

3.2 Topology

HART bus can operate in one of network, point to point and multi-drop, configurations.

Point to Point

In point to point mode, the analog signal is used to communicate one process variable and the digital signal gives access to secondary variables and other data that can be used for operations, commissioning, maintenance and diagnostic purposes. Only one HART slave device can exist in HART bus and the polling address must be zero.

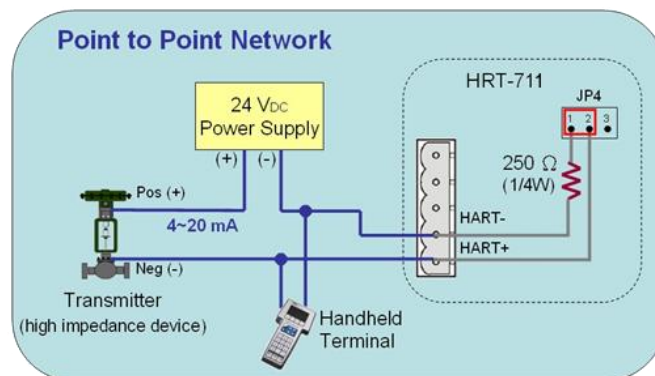

Multi-drop

In multi-drop mode, all process values are transmitted digitally. The polling address of all field devices must be bigger than 0 and between 1 ~ 15. The current through each device is fixed to a minimum value (typically 4 mA). The maximum HART device number in HART bus is up to 15.

NOTE: The built-in resistor in HRT-711 is 250 Ohm with 1/4W. Therefore, HRT-711 supports to connect the maximum 7 HART devices simultaneously. If the HART devices in multi-drop mode are more than 7, then users need to disconnect the built-in resistor in HRT-711 (prevent to burn down) and use the external 250 Ohm resistor with 1W.

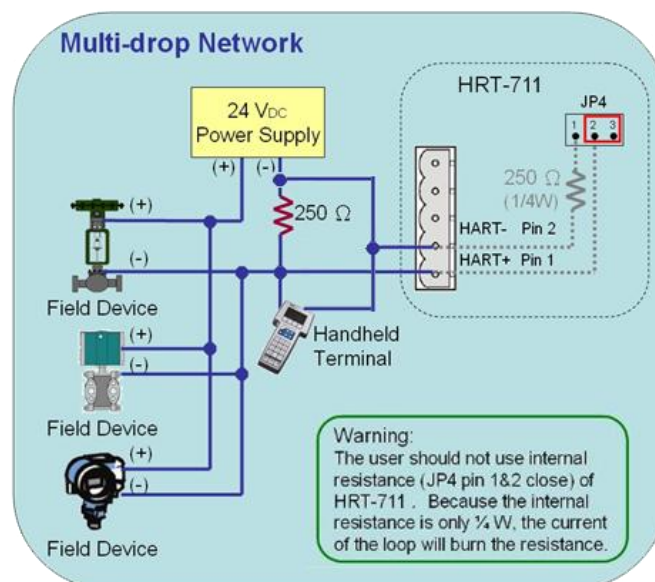

3.3 HART Frame

The HART frame format is shown as below



Master to Slave Frame

Slave to Master Frame

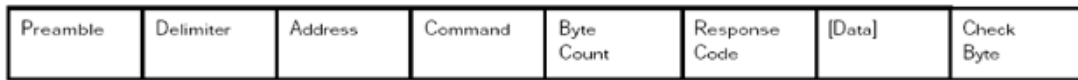

Field	Description																																						
Preamble	All frames transmitted by HART master or slave devices are preceded by a specified number of "0xFF" characters and they are called the preamble. The number of preamble can't be less than 5 and more than 20																																						
Delimiter	This data can indicate the frame is long or short frame and the frame is master frame, slave frame or burst frame.																																						
Address	If the HART frame is short frame, the address field is only one byte. If it is long frame, the address field are 5 bytes and include manufacturer ID, device type and device ID.																																						
Command	<p>The HART command set can be divided into Universal, Common Practice and Device-Specific class. These three class shown as below :</p> <table border="1"> <thead> <tr> <th>Command Number</th> <th>Command Class</th> </tr> </thead> <tbody> <tr> <td>Universal</td> <td>0~30, 31 is reserved</td> </tr> <tr> <td>Common Practice</td> <td>32~126, 127 is reserved</td> </tr> <tr> <td>Device-Specific</td> <td>128~253</td> </tr> <tr> <td>Reserved</td> <td>254 & 255</td> </tr> </tbody> </table> <p>Please refer to Appendix A for more detail of HART command</p>	Command Number	Command Class	Universal	0~30, 31 is reserved	Common Practice	32~126, 127 is reserved	Device-Specific	128~253	Reserved	254 & 255																												
Command Number	Command Class																																						
Universal	0~30, 31 is reserved																																						
Common Practice	32~126, 127 is reserved																																						
Device-Specific	128~253																																						
Reserved	254 & 255																																						
Byte Count	It is the number of bytes between it and the check byte the end of the HART frame.																																						
Response Code	<p>It includes two bytes of status. These bytes convey three types of information: Communication errors, Command response problems and Field device status. They are shown as below.</p> <table border="1"> <thead> <tr> <th>Response Code Data</th> <th>Byte1</th> <th>Byte0</th> </tr> </thead> <tbody> <tr> <td></td> <td></td> <td></td> </tr> </tbody> </table> <p>NOTE : When first byte shows the communication error, the value of the second byte is 0</p> <table border="1"> <thead> <tr> <th colspan="8">Byte 0 represents the communication error or response code</th> </tr> <tr> <th colspan="8">This byte is used for error status when Bit7 is 1. The status bits are shown as follow</th> </tr> <tr> <th>Bit7</th> <th>Bit6</th> <th>Bit5</th> <th>Bit4</th> <th>Bit3</th> <th>Bit2</th> <th>Bit1</th> <th>Bit0</th> </tr> </thead> <tbody> <tr> <td>1</td> <td>Parity Error</td> <td>Overrun error</td> <td>Framing Error</td> <td>Checksum error</td> <td>0(Reserved)</td> <td>RX buffer overflow</td> <td>Overflow (Undefined)</td> </tr> </tbody> </table>	Response Code Data	Byte1	Byte0				Byte 0 represents the communication error or response code								This byte is used for error status when Bit7 is 1. The status bits are shown as follow								Bit7	Bit6	Bit5	Bit4	Bit3	Bit2	Bit1	Bit0	1	Parity Error	Overrun error	Framing Error	Checksum error	0(Reserved)	RX buffer overflow	Overflow (Undefined)
Response Code Data	Byte1	Byte0																																					
Byte 0 represents the communication error or response code																																							
This byte is used for error status when Bit7 is 1. The status bits are shown as follow																																							
Bit7	Bit6	Bit5	Bit4	Bit3	Bit2	Bit1	Bit0																																
1	Parity Error	Overrun error	Framing Error	Checksum error	0(Reserved)	RX buffer overflow	Overflow (Undefined)																																

This byte is used for response code when Bit7 is 0.							
Bit7	Bit6	Bit5	Bit4	Bit3	Bit2	Bit1	Bit0
0	Response Code						
Response Code		Description					
0		No command-specific error					
1		Undefined					
2		Invalid selection					
3		Passed parameter too large					
4		Passed parameter too small					
5		Too few data bytes received					
6		Device-specific command error (rarely used)					
7		In write-protect mode					
8~15		Multiple meanings					
16		Access restricted					
28		Multiple meanings					
32		Device is busy					
64		Command not implemented					
Byte 1 indicates field device status							
Bit 7		Field device malfunction					
Bit 6		Configuration changed					
Bit 5		Cold start					
Bit 4		More status available					
Bit 3		Analog output current fixed					
Bit 2		Analog output saturated					
Bit 1		Non-primary variable out of limits					
Bit 0		Primary variable out of limits					
Data	The contents of the data are decided by HART command number.						
Check Byte	Every HART frame has a check byte at the last data byte. HART device can detect error frame by this byte.						

Section 4- Modbus Communication

4.1 Module Execution Process

When the HRT-711 module is started, it will perform the Initial mode first and then the Operation mode.

- (1) When HRT-711 runs in Initial mode, it will execute all initial command and the HART led will flash.
- (2) When HRT-711 runs in Operation mode, it will execute all polling command automatically and the HART led will always on.

4.2 Modbus / HART Mapping Table

Users can access the HART device by using these Modbus address defined by HRT-711 module. These Modbus address can be divided into two parts as below.

- (1) Input Data Area (FC04)
- (2) Output Data Area (FC06, FC16)

4.2.1 Input Data Area - User CMD Data

Modbus Addr (Hexadecimal)	Modbus Addr (Decimal)	Description
0x0~1F3	0~499	User CMD Data

4.2.2 Input Data Area - Module State Data

Modbus Addr (Hexadecimal)	Modbus Addr (Decimal)	Description	
0x1F4	500	High Byte	Low Byte
		Module request command count ⁽²⁾	Module state machine ⁽¹⁾
0x1F5	501	High Byte	Low Byte
		Module receive error command count ⁽²⁾	Module receive command count ⁽²⁾
0x1F6	502	High Byte	Low Byte
		Module error command index ⁽⁴⁾	Module error status ⁽³⁾
0x1F7~1F9	503~505	Reserved	

NOTE 1 : The module state machine represents current state of command handling. The meanings of the states are shown in the follow table.

Value	Status
0	Idle
1	Waiting to send HART command
2	Sending HART command.
3	Waiting to receive HART data
4	Receiving HART data.

NOTE 2 : In HRT-711, the module request and receive command and error count are used 1 byte respectively. Each request, receive or error will increase this byte until 256, then the value of will start from 0 again.

NOTE 3 : The module error status records the latest error status. The status is shown as following table.

Value	Error Status
0	No error
1	The command has never be executed
2	Receive timeout, can' t receive any HART data
3	Receive HART data is too short
4	The delimiter of HART data has some error
5	The address (the bit of master type) of HART data has some error
6	The address (the bit of burst mode) of HART data has some error
7	The command of HART data has some error
8	The parity of HART data has error
9	The communication with HART slave device has some error and the error messages are recorded in the responses codes

NOTE 4 : The module command index records the latest command index. There is no error occur when this byte is 255.

4.2.3 Input Data Area - Default CMD 0 Data

The HRT-711 will automatically add two default commands, CMD 0 and CMD 3, when add a HART device. The following table represents the default CMD 0 data Modbus address mapping.

Modbus Addr (Hexadecimal)	Modbus Addr (Decimal)	Description
0x1FA~200	506~512	Default CMD 0 input data of Module 0

0x201~207	513~519	Default CMD 0 input data of Module 1
0x208~20E	520~526	Default CMD 0 input data of Module 2
0x20F~215	527~533	Default CMD 0 input data of Module 3
0x216~21C	534~540	Default CMD 0 input data of Module 4
0x21D~223	541~547	Default CMD 0 input data of Module 5
0x224~22A	548~554	Default CMD 0 input data of Module 6
0x22B~231	555~561	Default CMD 0 input data of Module 7
0x232~238	562~568	Default CMD 0 input data of Module 8
0x239~23F	569~575	Default CMD 0 input data of Module 9
0x240~246	576~582	Default CMD 0 input data of Module 10
0x247~24D	583~589	Default CMD 0 input data of Module 11
0x24E~254	590~596	Default CMD 0 input data of Module 12
0x255~25B	597~603	Default CMD 0 input data of Module 13
0x25C~262	604~610	Default CMD 0 input data of Module 14
0x263~269	611~617	Default CMD 0 input data of Module 15

4.2.4 Input Data Area - Default CMD 3 Normal Format Data

When configure HRT-711 default CMD 3 to normal format, the data of Modbus address for each HART device is shown as following table.

Byte 0	Byte 1	Byte 2	Byte 3	Byte 4
Unit	Primary Variable of HART device (In IEEE 754 format)			
Byte 5	Byte 6	Byte 7	Byte 8	Byte 9
Unit	Secondary Variable of HART device (In IEEE 754 format)			
Byte 10	Byte 11	Byte 12	Byte 13	Byte 14
Unit	Tertiary Variable of HART device (In IEEE 754 format)			
Byte 15	Byte 16	Byte 17	Byte 18	Byte 19
Unit	Quaternary Variable of HART device (In IEEE 754 format)			

Modbus Addr (Hexadecimal)	Modbus Addr (Decimal)	Description
0x26A~276	618~630	Default CMD 3 Normal Format Data of Module 0
0x277~283	631~643	Default CMD 3 Normal Format Data of Module 1
0x284~290	644~656	Default CMD 3 Normal Format Data of Module 2
0x291~29D	657~669	Default CMD 3 Normal Format Data of Module 3
0x29E~2AA	670~682	Default CMD 3 Normal Format Data of Module 4
0x2AB~2B7	683~695	Default CMD 3 Normal Format Data of Module 5
0x2B8~2C4	696~708	Default CMD 3 Normal Format Data of Module 6

0x2C5~2D1	709~721	Default CMD 3 Normal Format Data of Module 7
0x2D2~2DE	722~734	Default CMD 3 Normal Format Data of Module 8
0x2DF~2EB	735~747	Default CMD 3 Normal Format Data of Module 9
0x2EC~2F8	748~760	Default CMD 3 Normal Format Data of Module 10
0x2F9~305	761~773	Default CMD 3 Normal Format Data of Module 11
0x306~312	774~786	Default CMD 3 Normal Format Data of Module 12
0x313~31F	787~799	Default CMD 3 Normal Format Data of Module 13
0x320~32C	800~812	Default CMD 3 Normal Format Data of Module 14
0x32D~339	813~825	Default CMD 3 Normal Format Data of Module 15

4.2.5 Input Data Area - Module Error Record Data

The HRT-711 records the latest 3 error when HART communication has error. These 3 records are put themodule error record data. The format of each record is shown as following table.

Byte 0	The length of send data
Byte 1~53	The record of send data
Byte 54	The length of receive data
Byte 55~109	The record of receive data
Byte 110~113	The time stamp record
Byte 114~115	Reserved

Modbus Addr (Hexadecimal)	Modbus Addr (Decimal)	Description
0x33A~373	826~883	Module Error Record 1
0x374~3AD	884~941	Module Error Record 2
0x3AE~3E7	942~999	Module Error Record 3

4.2.6 Input Data Area - Default CMD 0&3 Status Data

It consists of two bytes. The first byte is the state of Default CMD 0 and the second byte is the state of Default CMD 3.

Ex: If the value is 0x0100 for the MB address 1000, then the low byte of the 1000 is 0x00 and the high byte of the 1000 is 0x01. It means the error status of Default CMD 0 is 0x00 and the error status of Default CMD 3 is 0x01 in Module 0.

High Byte	Low Byte
CMD 3 Status	CMD 0 Status

Modbus Addr (Hexadecimal)	Modbus Addr (Decimal)	Description
0x3E8	1000	Default CMD 0&3 status of Module 0
0x3E9	1001	Default CMD 0&3 status of Module 1
0x3EA	1002	Default CMD 0&3 status of Module 2
0x3EB	1003	Default CMD 0&3 status of Module 3
0x3EC	1004	Default CMD 0&3 status of Module 4
0x3ED	1005	Default CMD 0&3 status of Module 5
0x3EE	1006	Default CMD 0&3 status of Module 6
0x3EF	1007	Default CMD 0&3 status of Module 7
0x3F0	1008	Default CMD 0&3 status of Module 8
0x3F1	1009	Default CMD 0&3 status of Module 9
0x3F2	1010	Default CMD 0&3 status of Module 10
0x3F3	1011	Default CMD 0&3 status of Module 11
0x3F4	1012	Default CMD 0&3 status of Module 12
0x3F5	1013	Default CMD 0&3 status of Module 13
0x3F6	1014	Default CMD 0&3 status of Module 14
0x3F7	1015	Default CMD 0&3 status of Module 15
0x3F8~419	1016~1049	Reserved

4.2.7 Input Data Area - User CMD Error Status

The HRT-711 supports maximum 100 User CMD. The index of the User CMD is from 0 to 99. Each Modbus address represents two User CMD statuses.

Ex: If the value is 0x0200 for the MB address 1050, then the low byte of the 1050 is 0x00 and the high byte of the 1050 is 0x02. It means the error status of User CMD Index 0 is 0x00 and the error status of User CMD Index 1 is 0x02.

Modbus Addr (Hexadecimal)	Modbus Addr (Decimal)	Description
0x41A~44B	1050~1099	User CMD Index 0~99 error status

4.2.8 Input Data Area - Module Hardware Data

Modbus Addr (Hexadecimal)	Modbus Addr (Decimal)	Description
0x44C~44D	1100~1101	Module ID (An ASCII value to represent HART)
0x44E~455	1102~1109	Module Name (An ASCII value to represent the 16-byte module name)
0x456~459	1110~1113	Module Firmware Version (An ASCII value to represent the 8-byte firmware version)
0x45A~47D	1114~1149	Reserved

4.2.9 Input Data Area - Through Mode Data

Modbus Addr (Hexadecimal)	Modbus Addr (Decimal)	Description	
0x47E	1150	High Byte	Low Byte
		Receive count in through mode	Send count in through mode
0x47F	1151	High Byte	Low Byte
		Reserved	Receive error count in through mode
0x480	1152	Receive length in through mode	
0x481~50E	1153~1294	Receive data in through mode	
0x50F~513	1295~1299	Reserved	

4.2.10 Input Data Area - Default CMD 3 Simple Format Data

When configure HRT-711 default CMD 3 to simple format, the data of Modbus address for each HART device is shown as following table.

Byte 0	Byte 1	Byte 2	Byte 3
Primary Variable of HART device (In IEEE 754 format)			
Byte 4	Byte 5	Byte 6	Byte 7
Secondary Variable of HART device (In IEEE 754 format)			
Byte 8	Byte 9	Byte 10	Byte 11
Tertiary Variable of HART device (In IEEE 754 format)			
Byte 12	Byte 13	Byte 14	Byte 15
Quaternary Variable of HART device (In IEEE 754 format)			

Modbus Addr (Hexadecimal)	Modbus Addr (Decimal)	Description
0x514~51D	1300~1309	Default CMD 3 Simple Format data of Module 0
0x51E~527	1310~1319	Default CMD 3 Simple Format data of Module 1
0x528~531	1320~1329	Default CMD 3 Simple Format data of Module 2
0x532~53B	1330~1339	Default CMD 3 Simple Format data of Module 3
0x53C~545	1340~1349	Default CMD 3 Simple Format data of Module 4
0x546~54F	1350~1359	Default CMD 3 Simple Format data of Module 5
0x550~559	1360~1369	Default CMD 3 Simple Format data of Module 6
0x55A~563	1370~1379	Default CMD 3 Simple Format data of Module 7
0x564~56D	1380~1389	Default CMD 3 Simple Format data of Module 8
0x56E~577	1390~1399	Default CMD 3 Simple Format data of Module 9
0x578~581	1400~1409	Default CMD 3 Simple Format data of Module 10
0x582~58B	1410~1419	Default CMD 3 Simple Format data of Module 11
0x58C~595	1420~1429	Default CMD 3 Simple Format data of Module 12
0x596~59F	1430~1439	Default CMD 3 Simple Format data of Module 13
0x5A0~5A9	1440~1449	Default CMD 3 Simple Format data of Module 14
0x5AA~5B3	1450~1459	Default CMD 3 Simple Format data of Module 15

4.2.11 Output Data Area

Modbus Addr (Hexadecimal)	Modbus Addr (Decimal)	Description
0x0~1F3	0~499	User command
0x1F4	500	High Byte
		Low Byte
0x1F5	501	Reserved
		Reset module state function ⁽¹⁾
0x1F6	502	High Byte
		Low Byte
0x1F7	503	Reserved
		Auto Polling function ⁽²⁾
0x1F8	504	Reserved
		Output Trigger function ⁽³⁾
0x1F9	505	Reserved
0x1FA~76B	506~1899	Reserved (For Module Configuration)
0x76C	1900	High Byte
		Low Byte
0x76D	1901	Reserved
		Channel selection in through mode
0x76E	1902	Send data length in through mode
0x76E~7FB	1902~2043	Send data in through mode

NOTE 1 : When write the value greater than zero, the module will clear module request count, module

response count, module error count, module error status and set module error command index to 255. To complete reset procedure, user has to write 0 to this field.

NOTE 2 : When set the value to be 1, the module will execute all HART polling commands automatically.

NOTE 3 : If change the value, the module will refer to the index value (0~99, 255 is for through mode) of trigger command to execute the corresponding user command. Ex: If the index of trigger command is 0 and the output trigger function value is 1, when change the value of output trigger function from 1 to 2, the module will execute the user command (index = 0).

4.3 Through Mode

In this mode, users can send and receive the HART command directly. Please refer to the below steps.

Step 1 : Set the Channel to 0. (Through Mode just support channel 0) [Address : 1900, Low Byte]

Step 2 : Set the Send length [Address : 1901]

Step 3 : Set the HART command data. [Address : 1902~2043]

Ex: 0xFF 0xFF 0xFF 0xFF 0xFF 0x02 0x80 0x00 0x00 0x82

Step 4 : Set the Auto Polling to 0. (In this mode, Auto Polling function can not be enabled.) [Address : 501, Low Byte]

Step 5 : Set the The index of trigger command to 255. [Address : 502, High Byte]

Step 6 : Get the receive count from Receive count in through mode [Address : 1150, High Byte] and error count from Error count in through mode [Address : 1151, Low Byte].

Step 7 : Change the Output Trigger function value. [Address : 502, Low Byte]

Step 8 : Get the value of Receive count in through mode and Error count in through mode until one of them is different than the last value.

Step 9 : If the Receive count in through mode is different than the last value, the user can get the receive length from Receive length in through mode and the user can get receive data from Receive data in through mode [Address : 1153 ~] according to receive data length. [Address : 1152]

(If the Error count in through mode is different than the last value, it means it can not receive any data.)

Section 5- Utility

5.1 .NET Framework Installation

The Utility for HRT-711 needs .NET Framework to run. The version of .NET Framework to execute Utility has to be greater than 2.0. If users do not have this, please ignore this section and jump to section 5.2.

Microsoft .Net Framework Version 2.0 :

<http://www.microsoft.com/downloads/details.aspx?FamilyID=0856eacb-4362-4b0d-8edd-aab15c5e04f5&DisplayLang=en>

The .NET Framework install steps are shown in the below :

Step 1 : Press the Next button.

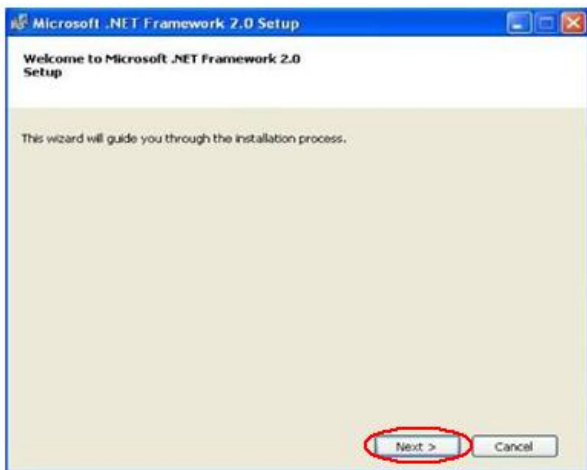

Step 2 : Check the "I accept the terms of the License Agreement" and click Install button.

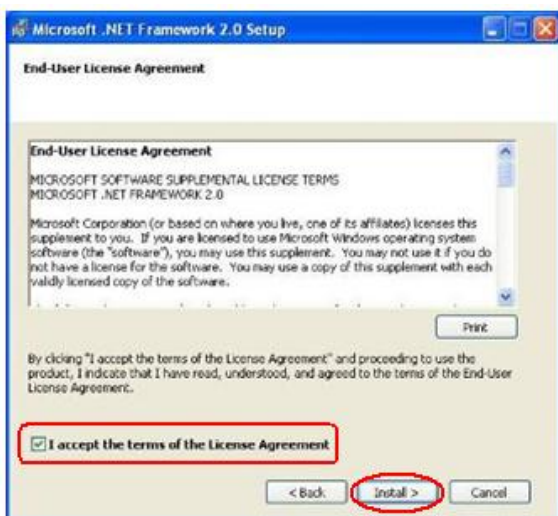

Step 3 : After finishing the installation, press Finish button to exit.

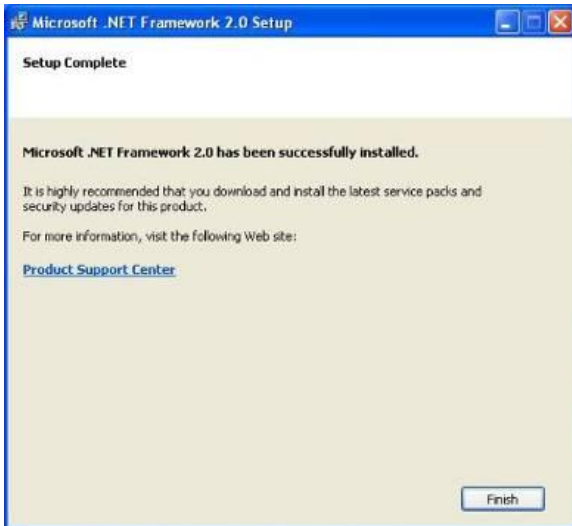

5.2 Install HRT-711 Utility

Step 1 : Download the installation file of HRT-711 Utility from the CD-ROM disk (CD:\hart\gateway\hrt-711\utilities) or the web site (ftp://ftp.icpdas.com.tw/pub/cd/fieldbus_cd/hart/gateway/hrt-711/utilities/)

Step 2 : Execute the HRT-711 Utility x.x.x.x.exe (x.x.x.x is the version of the install package) file to install the Utility, and then click Next button.

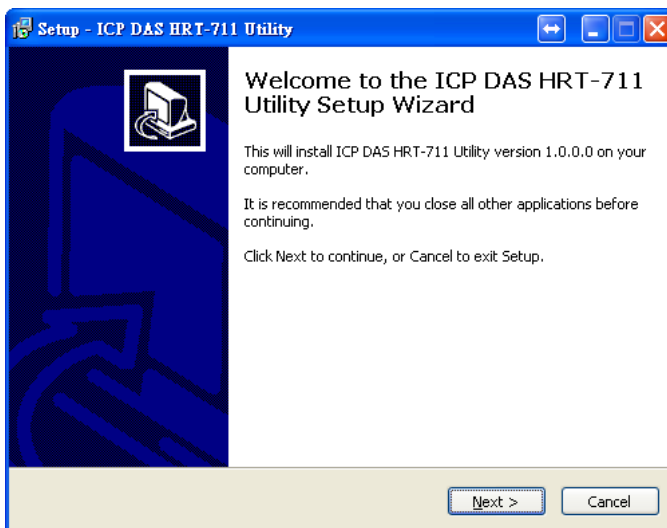

Step 3 : Click the Next button to continue. If you want to change the installation destination, click Browse button to select the installation path.

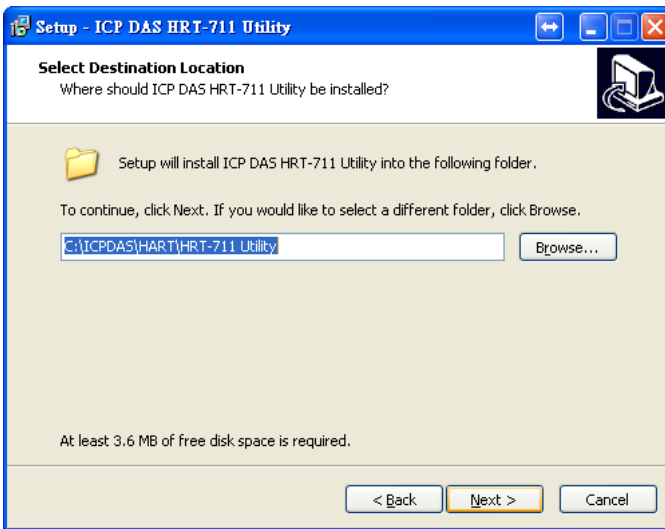

Step 4 : Choose the name and the path to install in the Start Menu, and then click Next.

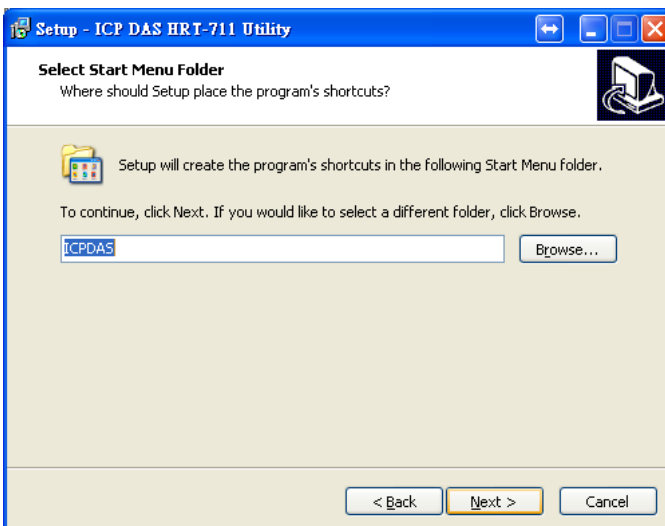

Step 5 : Click Install to start installation

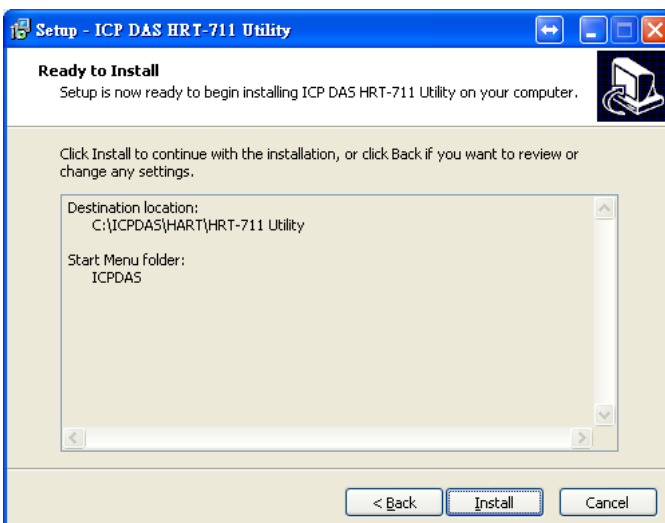

Step 6 : Wait the installation finish, then check “View Patch Note.txt” if you want and click Finish to complete the installation.

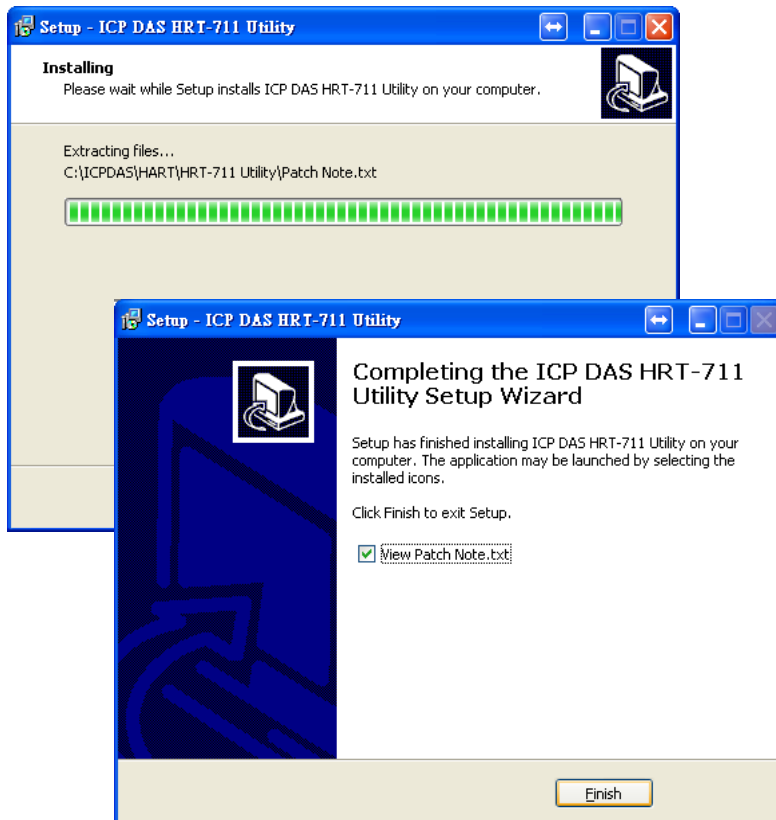

Step 7 : Users can execute the Utility in the follow path.

Windows XP

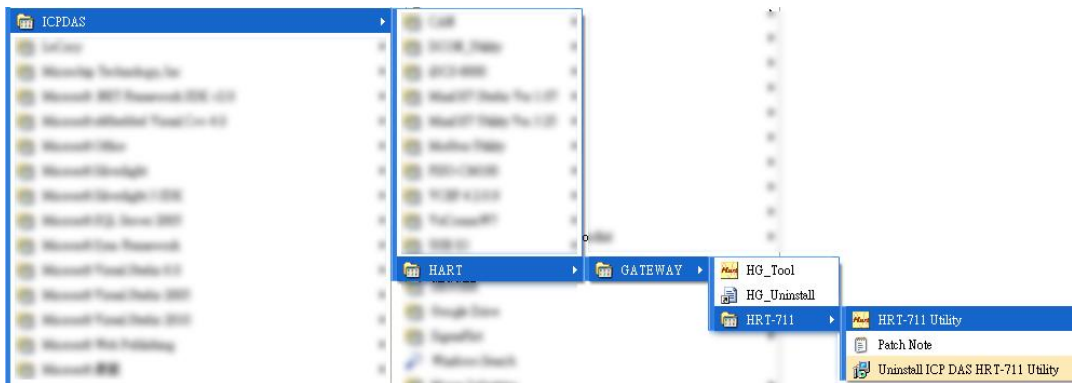

Windows 7

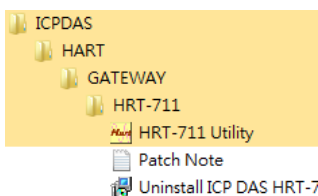

5.3 Introduction of Utility

The HRT-711 has, Ethernet and HART, two interfaces. The Utility can configure these two interfaces. Users have to choose which interface to configure in the first form of the Utility. User can click the figure to choose interface. The detail of the configuration of these two interfaces will be discuss in the follow section.

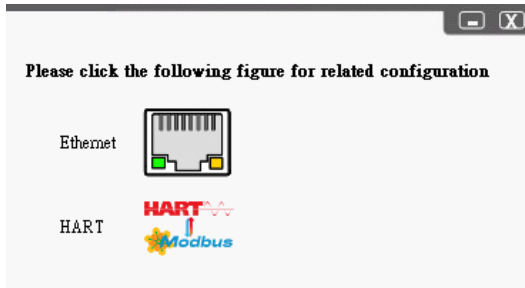

5.4 Configuration of Ethernet

The Ethernet interface of HRT-711 handles the Modbus/TCP protocol. Users have to configure the interface for appropriate configuration (IP, Sub-net mask...etc) for using.

Click Search Servers in this form to search all ICPDAS devices.

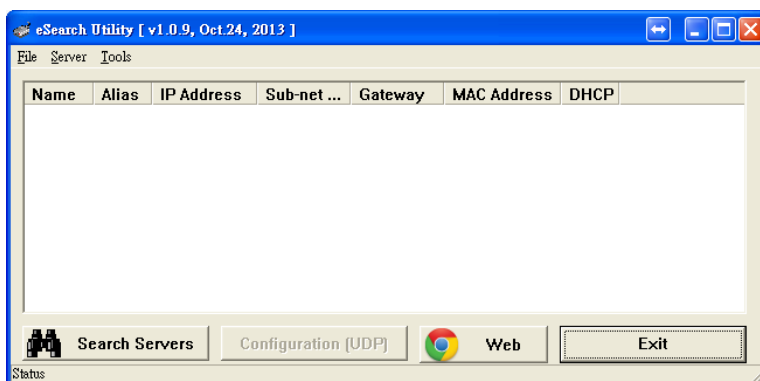

The HRT-711 will list in this form after searching. If the HRT-711 does not list in this form, please check the network connection or the power of the HRT-711.

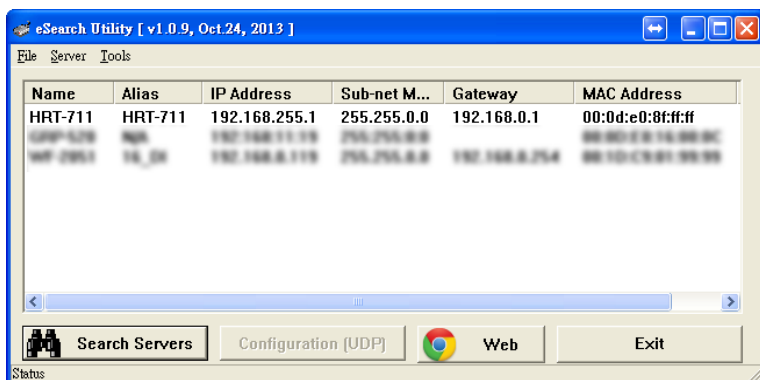

Users can configure the network parameters by double clicking HRT-711 in the list. Users can modify the parameters to appropriate setting for users' application, then click OK button to apply the new setting.

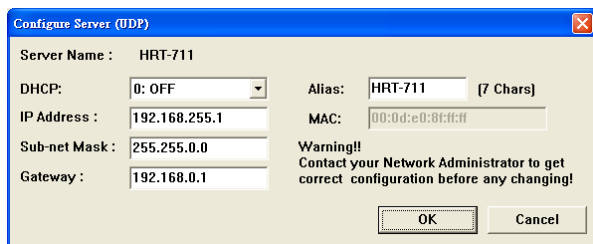

After assigning parameter, user can click Exit to exit the Network Configuration form.

5.5 Configuration of Modbus to HART

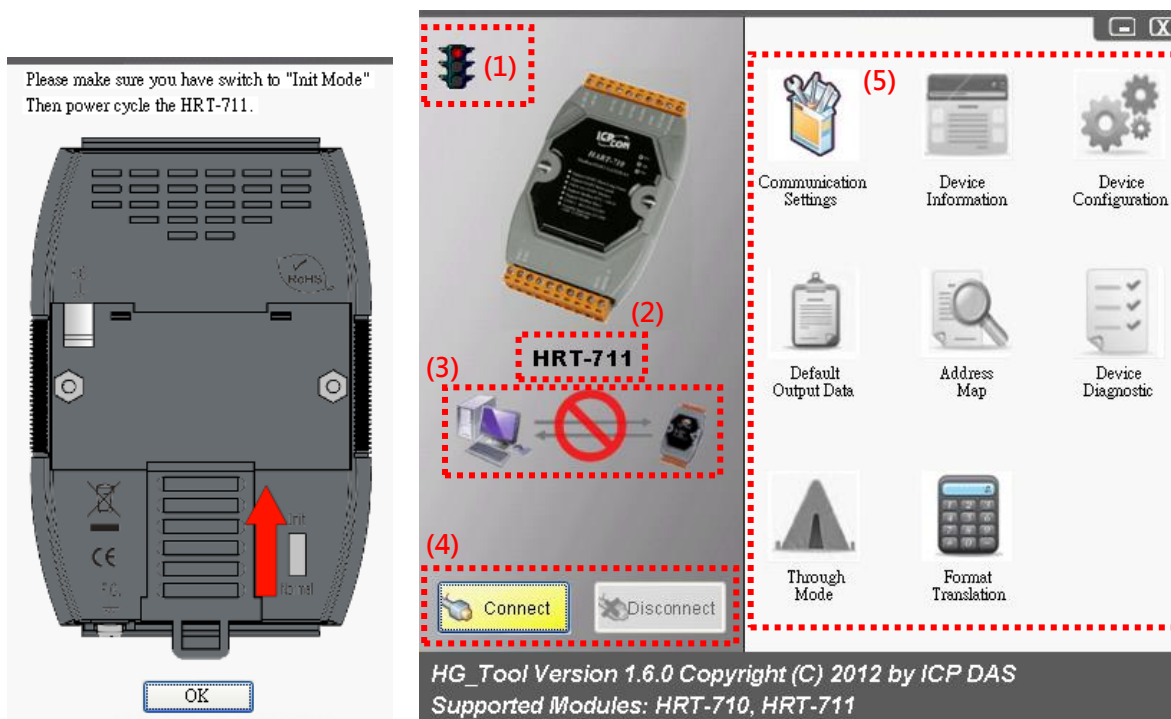

The HRT-711 is the Modbus/TCP to HART gateway. It not only has to configure the Ethernet but also the HART interface.

NOTE : Before configuring HART interface, users have to switch the Init Mode switch to Init then power cycle the HRT-711.



The HART configuration form can divide into 5 parts. These 5 parts are Traffic Light, Current Config Module Name, Connection Status, Connection Controll and Tools. The following section will describe each part and functionalities.



5.5.1 Traffic Light

Sign	Status
	The Com port of PC has not opened yet
	The Com port of PC has opened and tried to connect to the module
	The PC connects to module successfully



5.5.2 Current Config Module Name

The Current Config Module Name displays the current module name to configure. This Utility also supports HRT-710. So, the Current Config Module Name helps users to know what module is under configuring.

5.5.3 Connection Status

Figure	Status
	The Com port of PC has not opened
	The Com port of PC has opened and tried to connect to the module
	The PC connects to the module successfully







5.5.4 Connection Control

Button	Function
	When clicks this button, the PC will open the Com port and try to connect to the module.
	When clicks this button, the PC will break the connection of the module and close the Com port.

5.5.5 Tools

The Utility contains many tools for configuration and debug. The following table lists all tools and its functionalities.

Tool	Functionality
	Communication Setting The Com Port setting for the PC

 Device Information	Device Information Display the configuration of the device
 Device Configuration	Device Configuration Change the configuration
 Default Output Data	Default Output Data The configuration for boot-up default output of User CMD
 Address Map	Address Map Display the Modbus Address mapping of User CMD
 Device Diagnostic	Device Diagnostic Display current status of HART command of the module
 Through Mode	Through Mode Send/Receive the HART command
 Format Translation	Format Translation Translate Packed ASCII and IEEE 754 format

5.5.5.1 Communication Settings

User can choose what device to configure. In this manual, please select HRT-711 in the dropdown list, and then select the Com Port number connected to HRT-711.

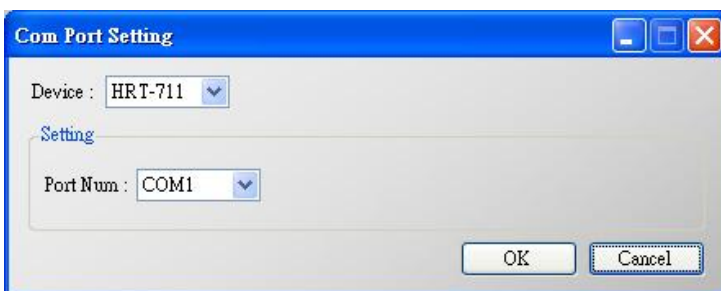

5.5.5.2 Device Information

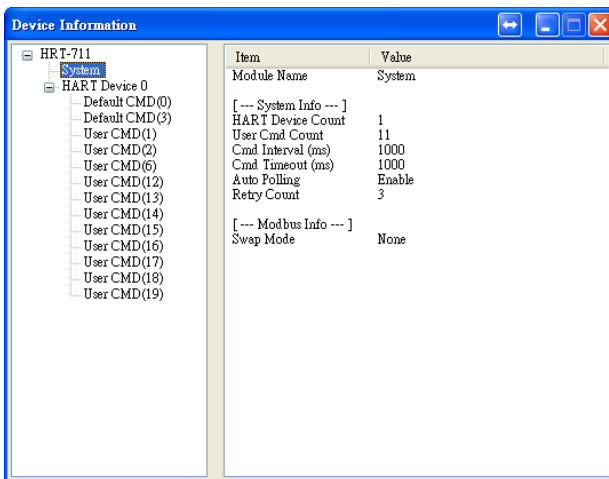

It shows the configuration of the module. When clicking the left item, it will show the item data in the right side. About the data of these items is shown as following table.

Node	Mouse	Behavior
HRT-711	Left Click	Display configuration
System	Left Click	Display configuration
	Right Click ⁽¹⁾	Generate Pop-up menu Basic Operation and Advanced Operation
HART Device N	Left Click	Display configuration
Default CMD (N)	Left Click	Display configuration
	Right Click ⁽²⁾	Generate Pop-up menu Basic Operation and Advanced Operation
User CMD (N)	Left Click	Display configuration
	Right Click ⁽²⁾	Generate Pop-up menu Basic Operation and Advanced Operation

(1) When right clicking the item of System, it will generate a pop-up menu. The functionalities of the menu will describe below :

- Basic Operation

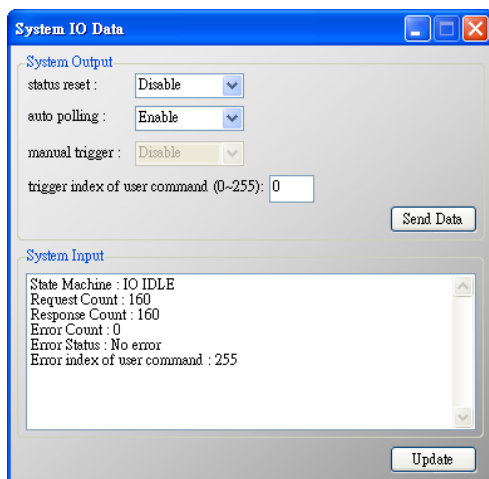

System Output	
status reset	When set the item to Enable, the module will clear module request count, module response count, module error count, module error status and set module error command index to 255
auto polling	When set the item to Enable, the module will execute all HART polling commands automatically
manual trigger	When set the item to Enable, the module will execute the user command once according to the value of trigger index of user command field
trigger index of user command	If users want to execute user command by manual mode, users must set the index value first
Send Data button	When click the button, it will update data in the System Output area to module
System Input	
State Machine	It will show the state machine of module
Request Count	It will show the request count of HART UserCmd
Response Count	It will show the response count of HART UserCmd
Error Count	It will show the response error count of HART UserCmd
Error Status	It will show the error status of HART UserCmd
Error index of user command	It will show the latest HART UserCmd that has error happened. If the index value is 255, it means no error happened
Update button	When click the button, it will update System Input data from the module

- Advanced Operation



Output Data
It has 6 bytes data. When click the Send Data button, it will send the output data to module. (Modbus Address: 500~502 in Output Data Area)
Input Data
It has 6 bytes data. When click the Update button, it will update the data from module. (Modbus Address: 500~502 in Input Data Area)

(2) When right clicking the item of Default or User CMD, it will generate a pop-up menu. The functionalities of the menu will describe below :

- Basic Operation

In the function, only supports HART command 0, 1, 2, 3, 6, 11, 12, 13, 14, 15, 16, 17, 18, 19 and the different HART command will show the different user command window (EX: The window of HART command 0 and 6 is shown as below).

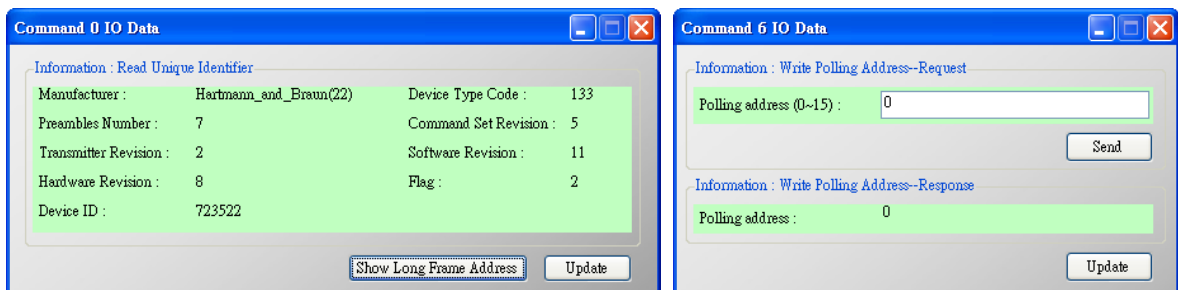

- Advanced Operation

Users can write/read HART command/response via this form. In this form, there are two buttons Send Data and Update. When click the Send Data button, it will send the output data to the module. And when click this button, it will update the input and output data from the module.

NOTE : About the Input data area of user command, the first 2 bytes are response code1 and code2 of HART command and the left bytes are the HART command data.

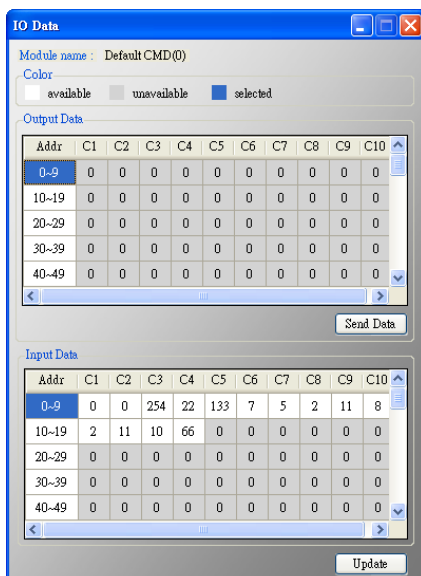

5.5.5.3 Device Configuration

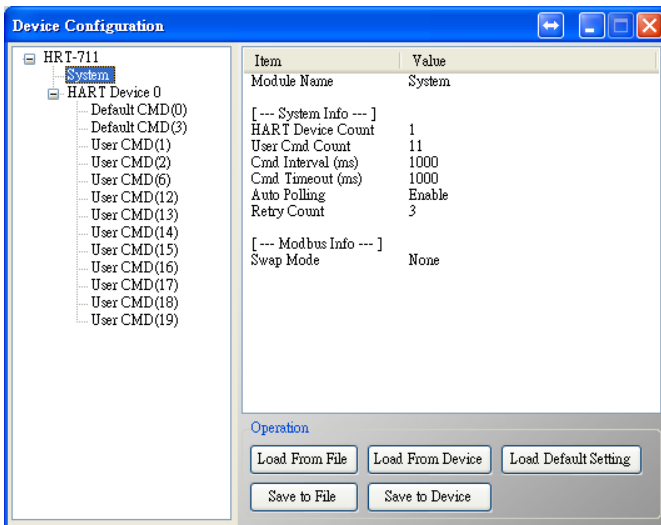

It will show the system configuration of HRT-710 and users can also configure HRT-710 here. When click the left item, it will show the corresponding item information in the right side of window. The following is detailed description.

Node	Mouse	Behavior
HRT-711	Left Click	Display configuration
System	Left Click	Display configuration
	Right Click ⁽¹⁾	Generate Pop-up menu Edit and Add Module
HART Device N	Left Click	Display configuration
Default CMD (N)	Left Click	Display configuration
	Right Click ⁽²⁾	Generate Pop-up menu Edit Delete and Add Command
User CMD (N)	Left Click	Display configuration
	Right Click ⁽³⁾	Generate Pop-up menu Edit and Delete

(1) When right clicking the item of System, it will generate a pop-up menu. The functionalities of the menu will describe below :

- Edit

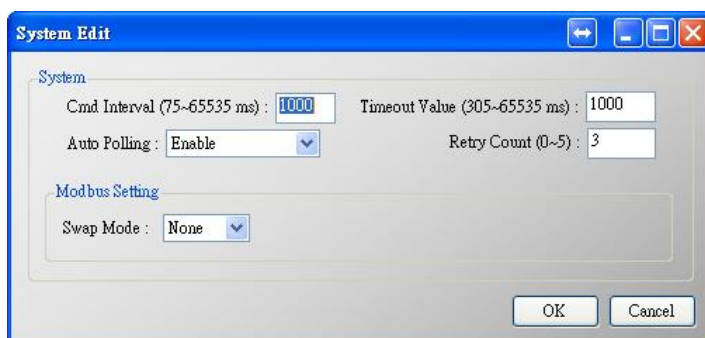

It is used to set the communicating parameters of HART and Modbus and described as below.

System											
Cmd Interval	The polling interval of HART Cmd										
Timeout Value	The timeout value of HART Cmd.										
Auto Polling	If the function is enabled, the HRT-711 will execute all HART polling Cmd automatically.										
Retry Count	When HART comm. error happened, the HRT-711 will re-send the HART Cmd for Retry count times.										
Modbus Setting											
Swap Mode	<p>It is used for the format of the word data in Modbus. The option are None / Byte / Word / W&B.</p> <p>Ex : 2 words data (0x1234, 0x5678) from HRT-711. Users can set the swap mode for different data format.</p> <table border="1"> <thead> <tr> <th>Swap Mode</th> <th>Data</th> </tr> </thead> <tbody> <tr> <td>None</td> <td>0x1234 0x5678</td> </tr> <tr> <td>Byte</td> <td>0x3412 0x7856</td> </tr> <tr> <td>Word</td> <td>0x5678 0x1234</td> </tr> <tr> <td>W&B</td> <td>0x7856 0x3412</td> </tr> </tbody> </table>	Swap Mode	Data	None	0x1234 0x5678	Byte	0x3412 0x7856	Word	0x5678 0x1234	W&B	0x7856 0x3412
Swap Mode	Data										
None	0x1234 0x5678										
Byte	0x3412 0x7856										
Word	0x5678 0x1234										
W&B	0x7856 0x3412										

- Add Module

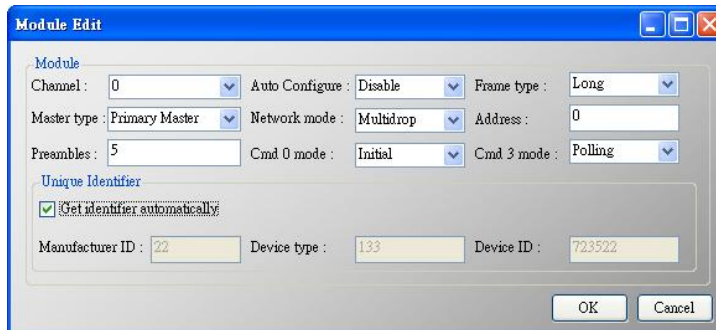

It is used to set the communicating mode for HART devices and described as below.

Module	
Channel	0~7. (Only channel 0 supports now)
Auto Configure	<p>If enables this function, the HRT-710 will detect the frame type, address, preambles, manufacturer ID, device type and device ID of HART device automatically</p> <p>Warning : If enables this function, just supports HART Point to Point mode</p>
Frame type	Short or Long frame
Master type	<p>Primary or Secondary Master</p> <p>Warning : In general, the HRT-711 should set to the Primary Master</p>
Network	Point to Point or Multi-drop mode.

mode	Point to Point : Only one HART slave device in HART bus Multi-drop : More than one HART devices can be in HART bus
Address	0~15 Warning : If the address of HART device is 0, it means in Point to Point mode
Preambles	5~20
Cmd 0 Mdoe	Disable ⁽¹⁾ / Initial ⁽²⁾ / Polling ⁽³⁾
Cmd 3 Mdoe	Disable ⁽¹⁾ / Initial ⁽²⁾ / Polling ⁽³⁾
Unique Identifier	
Auto Get Unique ID	If the frame type of HART slave device is long frame, users can enable this function to get unique ID automatically by short frame address
Manufacturer ID	Users can set the manufacturer ID for HART device. If the frame type is short, users can omits this setting
Device Type	Users can set the device type for HART device. If the frame type is short, users can omits this setting
Device ID	可手動填入 HART 設備的裝置 ID · 若 HART 設備的幀類型為短幀(Short frame)格式 · 則可忽略

(1) Disable : The HRT-711 will not execute the default HART Cmd

(2) Initial : The HRT-711 will execute the default HART Cmd automatically when in Initial mode.

(3) Polling : The HRT-711 will execute the default HART Cmd automatically when in Operation mode.

(2) When right clicking the item of HART Device N, it will generate a pop-up menu. The functionalities of the menu will describe below :

- **Edit**

Same as the selection Add Command in the pop-up menu when right click System, please refer to that section.

- **Delete**

Delete current selected module

- **Add Command**

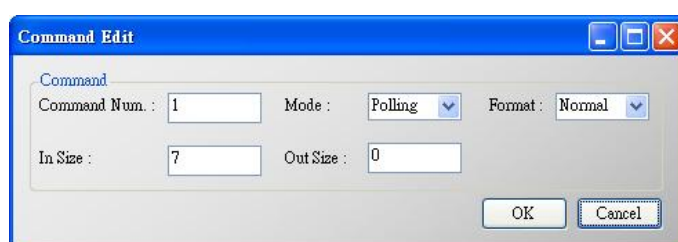

It is used to set the communicating parameter for HART User CMD. The details are described as

below :

Command	
Command Num	Set the HART command number
Mode	Initial ⁽¹⁾ / Polling ⁽²⁾ / Manual ⁽³⁾
Format	Normal ⁽⁴⁾ / Simple ⁽⁵⁾ (Data exchange format between HART and Modbus)
In Size	Set the input data length of HART command. Note: The size includes 2 bytes response code and data size of HART command. (Ex: HART Cmd 0 = 2(response code) + 12 = 14)
Out Size	Set the output data length of HART command.

(1) Initial : The module will run this command in initial mode

(2) Polling : The module will run this command in operation mode

(3) Manual : The module will run this command by manual

(4) Normal : When read / write HART data by Modbus, the data format is HART standard command format

(5) Simple : When read / write HART data by Modbus, the data format is simple format defined by HRT-710. The detailed description, please refer to the Appendix B. (In this mode, the HMI or SCADA software can read or write HART data and don't need to process any data. Now, it is only supported HART command number: 1, 2 and 3.)

(3) When right clicking the item of User CMD (N), it will generate a pop-up menu. The functionalities of the menu will describe below :

- Edit

Same as the selection Add Command in the pop-up menu when right click HART Device N, please refer to that section.

- Delete

Delete current selected User CMD (N)

5.5.5.4 Default Output Data

It is used to set the default value for all UserCMD output data.

(1) Click the left User CMD item and if the output length of the User CMD is not zero, then the occupied address will be blue in the right window.

(2) Double click the address field and it will show the Data Edit window to set the default value.

When finished all configuration, click Save to Device button to apply all setting. (The module will reboot

when click Save to Device button)

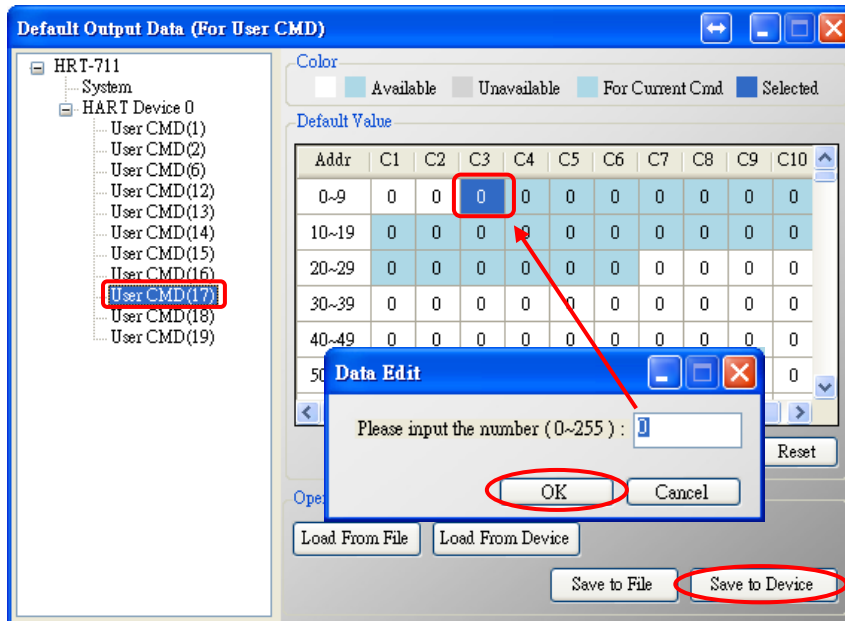

5.5.5.5 Address Map

It is used to show the MB address for all User CMD.

- (1) Click the left User CMD item and the occupied address of the User CMD will be blue in the right Modbus AO or Modbus AI table.
- (2) The data of Modbus AI table can be read by Modbus Function Code 4.
- (3) The data of Modbus AO table can be read by Modbus Function Code 3 and written by Modbus Function Code 6 or 16.



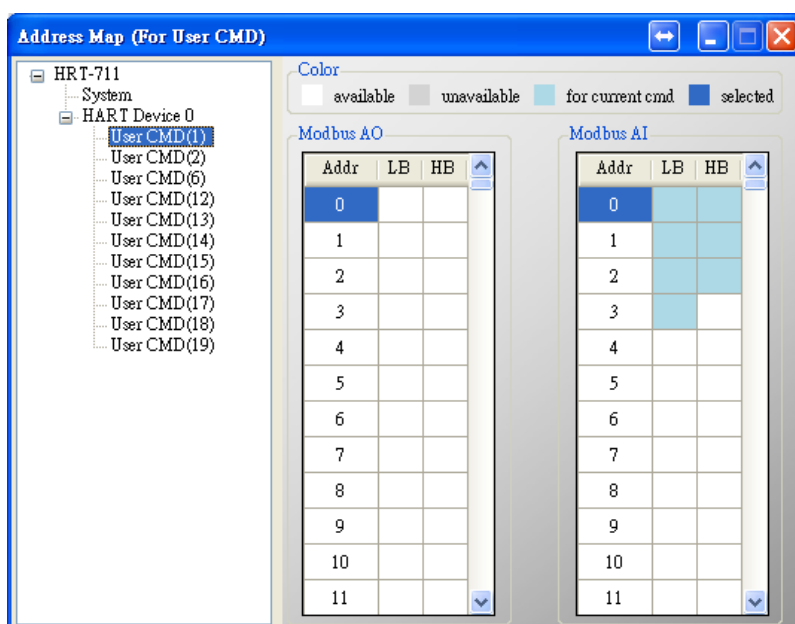

NOTE : The Modbus address of the default command is fixed, so users can refer to section 4.2 to get the address.



5.5.5.6 Device Diagnostic

It is used to show the status of HART command in the HRT-711.

- (1) Click the left User CMD item and the icon of the item will show the status described as below :

Figure	Status
	It means no error
	It means the command has never been executed
	It means the command has error and the error status shows at the right side of the window
	It means the item is selected

- (2) Status Update button : Refresh the status of HART Cmd

- (3) Record button : The HRT-711 records the latest error command and saves to Record 1~3. Users can get these records by click Record 1, Record 2 and Record 3 button.

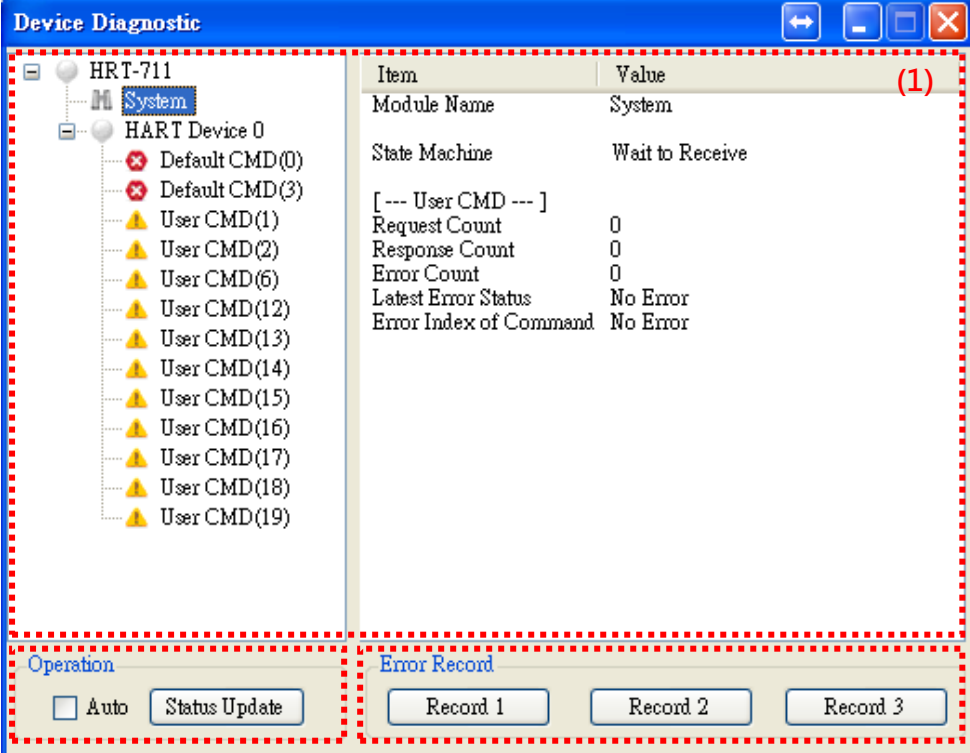

Device Diagnostic

HRT-711

- System
- HART Device 0
 - Default CMD(0)
 - Default CMD(3)
 - User CMD(1)
 - User CMD(2)
 - User CMD(6)
 - User CMD(12)
 - User CMD(13)
 - User CMD(14)
 - User CMD(15)
 - User CMD(16)
 - User CMD(17)
 - User CMD(18)
 - User CMD(19)

Item	Value
Module Name	System
State Machine	Wait to Receive
[--- User CMD ---]	
Request Count	0
Response Count	0
Error Count	0
Latest Error Status	No Error
Error Index of Command	No Error

Operation

Auto **Status Update**

Error Record

Record 1 **Record 2** **Record 3**

5.5.5.7 Through Mode

It is used to send / receive HART command directly. Users have check the items below before using through mode function.

- (1) The RUN led is always on.
- (2) The auto polling function is disabled.

Here is an example to send / receive HART command 0 :

Step 1 In Send field, fill in the data "0xFF 0xFF 0xFF 0xFF 0xFF 0x02 0x80 0x00 0x00" and then click Send button to send HART Cmd.

Step 2 Click Update button to show the response of HART device.

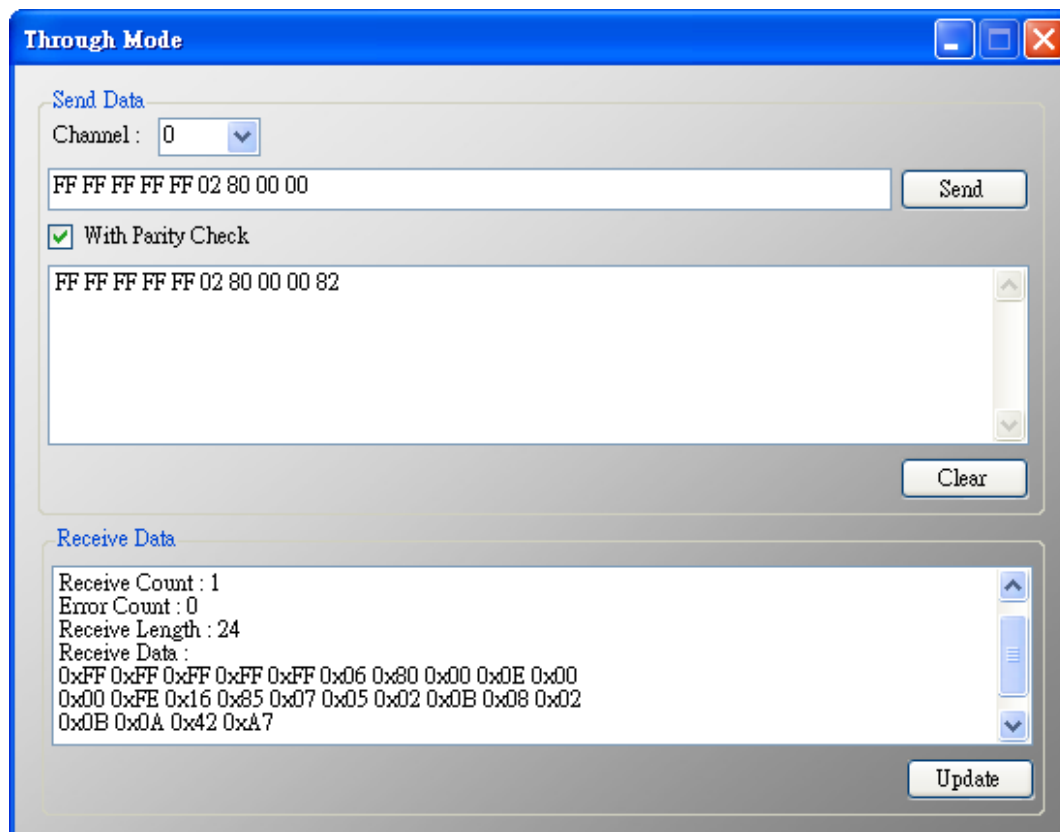

5.5.5.8 Format Translation

Here we provide some tools for HART communication. Packed ASCII Translate tool can convert Packed ASCII into ASCII format. IEEE754 Translate tool can convert IEEE754 into byte format.

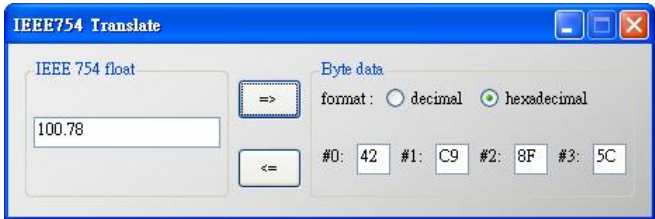
功能	説明
<p>Packed ASCII Translate</p>	<p>It can be used to convert between Packed ASCII and ASCII format</p> 
<p>IEEE 754 Translate</p>	<p>It can be used to convert between IEEE754 and DWORD format</p> 

Appendix A HART Command

In this chapter, the following lists are the HART universal command format.

Command 0 : Read Unique Identifier

Request Data Bytes	0	
Response Data Bytes	2 + 12 = 14	
Byte Index	Format	Description
0	UInt8	Response Code 1
1	UInt8	Response Code 2
2	UInt8	254
3	UInt8	Manufacturer ID
4	UInt8	Manufacturer' s device ID
5	UInt8	Number of preambles needed in the request
6	UInt8	Command set revision number
7	UInt8	Transmitter specific revision code
8	UInt8	Software revision
9	UInt8	Hardware revision
10	UInt8	Flags
11~13	UInt24	Device ID number (MSB first)

Command 1 : Read Primary Variable

Request Data Bytes	0	
Response Data Bytes	2 + 5 = 7	
Byte Index	Format	Description
0	UInt8	Response Code 1
1	UInt8	Response Code 2
2	UInt8	Unit code
3~6	Float	Primary Variable

Command 2 : Read P.V. Current and Percentage of Range

Request Data Bytes	0	
Response Data Bytes	2 + 8 = 10	
Byte Index	Format	Description
0	UInt8	Response Code 1
1	UInt8	Response Code 2

2~5	Float	Primary Variable Current
6~9	Float	Primary Variable Percentage of Range

Command 3 : Read Dynamic Variables and P.V. Current

Request Data Bytes	0	
Response Data Bytes	2 + 8 = 10	
Byte Index	Format	Description
0	UInt8	Response Code 1
1	UInt8	Response Code 2
2~5	Float	Primary Variable Current
6	UInt8	Primary Variable Unit code
7~10	Float	Primary Variable
11	UInt8	Secondary Variable Unit code
12~15	Float	Secondary Variable
16	UInt8	Tertiary Variable Unit code
17~20	Float	Tertiary Variable
21	UInt8	Quaternary Variable Unit code
22~25	Float	Quaternary Variable

Command 6 : Write Polling Address

Request Data Bytes	1	
Byte Index	Format	Description
0	UInt8	Polling Address
Response Data Bytes	2 + 1 = 3	
Byte Index	Format	Description
0	UInt8	Response Code 1
1	UInt8	Response Code 2
2	UInt8	Polling Address

Command 11 : Read Unique Identifier Associated with TAG

Request Data Bytes	6	
Byte Index	Format	Description
0~5	PA6	TAG Name
Response Data Bytes	2 + 12 = 14	
Byte Index	Format	Description
0	UInt8	Response Code 1

1	Uint8	Response Code 2
2	Uint8	254
3	Uint8	Manufacturer ID
4	Uint8	Manufacturer' s device ID
5	Uint8	Number of preambles needed in the request
6	Uint8	Command set revision number
7	Uint8	Transmitter specific revision code
8	Uint8	Software revision
9	Uint8	Hardware revision
10	Uint8	Flags
11~13	Uint24	Device ID number (MSB first)

Command 12 : Read Message

Request Data Bytes	0	
Response Data Bytes	2 + 24 = 26	
Byte Index	Format	Description
0	Uint8	Response Code 1
1	Uint8	Response Code 2
2~25	PA24	Message

Command 13 : Read Tag, Descriptor, Date

Request Data Bytes	0	
Response Data Bytes	2 + 21 = 23	
Byte Index	Format	Description
0	Uint8	Response Code 1
1	Uint8	Response Code 2
2~7	PA6	TAG Name
8~19	PA12	Descriptor
20	Uint8	Day of month
21	Uint8	Month of year
22	Uint8	Year as offset to 1900

Command 14 : Read Primary Variable Sensor Information

Request Data Bytes	0	
Response Data Bytes	2 + 16 = 18	
Byte Index	Format	Description

0	Uint8	Response Code 1
1	Uint8	Response Code 2
2~4	Uint24	Sensor Serial Number (MSB first)
5	Uint8	Sensor limits unit
6~9	Float	Upper sensor limit
10~13	Float	Lower sensor limit
14~17	Float	Minimum span

Command 15 : Read Primary Variable Output Information

Request Data Bytes	0	
Response Data Bytes	2 + 17 = 19	
Byte Index	Format	Description
0	Uint8	Response Code 1
1	Uint8	Response Code 2
2	Uint8	Alarm select code
3	Uint8	Transfer function code
4	Uint8	PV range value unit code
5~8	Float	Upper range value
9~12	Float	Lower range value
13~16	Float	Damping value
17	Uint8	Write protect code
18	Uint8	Private label distribution code

Command 16 : Read Final Assembly Number

Request Data Bytes	0	
Response Data Bytes	2 + 3 = 5	
Byte Index	Format	Description
0	Uint8	Response Code 1
1	Uint8	Response Code 2
2~4	Uint24	Final assembly number (MSB first)

Command 17 : Write Message

Request Data Bytes	24	
Byte Index	Format	Description
0~23	PA24	Message
Response Data Bytes	2 + 24 = 26	

Byte Index	Format	Description
0	UInt8	Response Code 1
1	UInt8	Response Code 2
2~25	PA24	Message

Command 18 : Write Tag, Descriptor, Date

Request Data Bytes		21
Byte Index	Format	Description
0~5	PA6	TAG Name
6~17	PA12	Descriptor
18	UInt8	Day of month
19	UInt8	Month of year
20	UInt8	Year as offset to 1900
Response Data Bytes		2 + 21 = 23
Byte Index	Format	Description
0	UInt8	Response Code 1
1	UInt8	Response Code 2
2~7	PA6	TAG Name
8~19	PA12	Descriptor
20	UInt8	Day of month
21	UInt8	Month of year
22	UInt8	Year as offset to 1900

Command 19 : Write Final Assembly Number

Request Data Bytes		3
Byte Index	Format	Description
0~2	UInt24	Final assembly number (MSB first)
Response Data Bytes		2 + 3 = 5
Byte Index	Format	Description
0	UInt8	Response Code 1
1	UInt8	Response Code 2
2~4	UInt24	Final assembly number (MSB first)

Appendix B Command Format

The HART data format of Modbus address is divided into the Normal and Simple format.

1. Normal format

When read / write HART data by Modbus, the Modbus data format is HART standard command format.

2. Simple format

When read / write HART data by Modbus, the Modbus data format is simple format (omit the Response Code and Unit data). In this mode, the HMI or SCADA software can read or write HART data easily. Now, it only supports HART command number 1, 2 and 3.

The simple format of HART command

Command 1 : (Read Primary Variable)

Response Data Bytes		4
Byte Index	Format	Description
0~3	Float	Primary Variable

Command 2 : (Read P.V. Current and Percentage of Range)

Response Data Bytes		8
Byte Index	Format	Description
0~3	Float	Primary Variable Current
4~7	Float	Primary Variable Percentage of Range

Command 3 : (Read Dynamic Variables and P.V. Current)

Response Data Bytes		20
Byte Index	Format	Description
0~3	Float	Primary Variable Current
4~7	Float	Primary Variable
8~11	Float	Secondary Variable
12~15	Float	Tertiary Variable
16~19	Float	Quaternary Variable