

Software Guide

ICP DAS LinPAC-51XX SDK

Implement industry control with Linux Technique

(version 1.4)

Warranty

All products manufactured by ICP DAS are warranted against defective materials for a period of one year from the date of delivery to the original purchaser.

Warning

ICP DAS assume no liability for damages consequent to the use of this product. ICP DAS reserves the right to change this manual at any time without notice. The information furnished by ICP DAS is believed to be accurate and reliable. However, no responsibility is assumed by ICP DAS for its use, or for any infringements of patents or other rights of third parties resulting from its use.

Copyright

Copyright © 2011 by ICP DAS Co., Ltd. All rights are reserved.

Trademark

Names are used for identification purposed and only maybe registered trademarks of their respective companies.

License

The user can use, modify and backup this software **on a single machine.** The user may not reproduce, transfer or distribute this software, or any copy, in whole or in part.

Contents

1. Introduction	5
2. Installation of LinPAC-51XX SDK.....	7
2.1 Quick Installation of LinPAC-51XX SDK.....	7
2.2 The LinPAC-51XX SDK Introduction.....	9
2.2.1 Introduction to Cygwin.....	10
2.2.2 Introduction to Cross-Compilation.....	10
2.2.3 Download the LinPAC-51XX SDK	10
3.The Architecture of library in the LinPAC-51XX.....	11
4. LinPAC-51XX System Settings	13
4.1 Settings for the LinPAC-51XX Network	13
4.1.1 Setting the IP 、Netmask and Gateway	13
4.1.2 Setting of DNS.....	15
4.2 microSD Card Usage.....	15
4.2.1 Mount microSD Card.....	15
4.2.2 Umount microSD Card	16
4.2.3 Scan and repair microSD Card	16
4.3 USB Storage Device Usage	17
4.3.1 Mount USB Storage Device.....	17
4.3.2 Umount USB Storage Device	17
4.4 Adjust VGA Resolution	17
4.5 Running applications automatically at boot time	18
4.5.1 Making program run at boot time	19
4.5.2 Disabling program run at boot time	20
4.6 Automatic login	21
5. Instructions for the LinPAC-51XX.....	22
5.1 Basic Linux Instructions.....	22
5.1.1 ls : list the file information - > (like dir in DOS)	22
5.1.2 cd directory : Change directory - > (like cd in DOS).....	22
5.1.3 mkdir : create the subdirectory - > (like md in DOS).....	22
5.1.4 rmdir : delete(remove) the subdirectory and it must be empty - >	
(like rd in DOS).....	22
5.1.5 rm : delete file or directory - > (like del or deltree in DOS).....	23
5.1.6 cp : copy file - > (like copy in DOS)	23

5.1.7	mv : move or rename file or directory – > (like move or ren in DOS)	23
5.1.8	pwd : show the current path	23
5.1.9	who : show the on-line users	23
5.1.10	chmod : change authority of file	23
5.1.11	uname : show the version of linux	23
5.1.12	ps : show the procedures that execute now.....	24
5.1.13	ftp : transfer file	24
5.1.14	telnet : connect to other PC.....	24
5.1.15	date : show date and time.....	24
5.1.16	netstat : show the state of network	24
5.1.17	ifconfig : show the ip and network mask (like ipconfig in DOS).....	24
5.1.18	ping : check to see if the host in the network is alive.....	24
5.1.19	clear : clear the screen	24
5.1.20	passwd : change the password	24
5.1.21	reboot : reboot the LinPAC.....	24
5.2	General GCC Instructions	25
5.2.1	Compile without linking the LinPAC-51XX library	26
5.2.2	Compile with linking the LinPAC-51XX library (libi8k.a)	26
5.3	A Simple Example – Helloworld.c	27
5.4	i-Talk Utility	32
6	LIBI8K.A	33
6.1	System Information Functions	35
6.2	Watch Dog Timer Functions	57
6.3	EEPROM Read/Write Functions	60
6.4	Digital Input/Output Functions	64
6.4.1	I-7000 series modules	64
6.5	Analog Input Functions	81
6.5.1	I-7000 series modules	81
6.6	Analog Output Functions	93
6.6.1	I-7000 series modules	93
6.7	Error Code Explanation	104
7	Demo of LinPAC-51XX Modules With C Language	105
7.1	I-7k Modules DIO Control Demo	105
7.2	I-7k Modules AIO Control Demo	111
7.3	Conclusion of Module Control Demo	113
7.4	Timer Function Demo	113
8	Introduction of LinPAC-51XX Serial Ports	114
8.1	Introduction of COM1 Port of LinPAC-51XX	115

8.2 Introduction of COM2 Port of LinPAC-51XX	116
8.3 Introduction of COM3 Port of LinPAC-51XX	117
9. LinPAC-51XX Library Reference in C Language	118
9.1 List Of System Information Functions	118
9.2 List Of Digital Input/Output Functions.....	119
9.3 List Of Watch Dog Timer Functions.....	119
9.4 List Of EEPROM Read/Write Functions	119
9.5 List Of Analog Input Functions.....	119
9.6 List Of Analog Output Functions.....	120
10. Additional Support	121
10.1 GUI Funtion Support.....	121
10.1.1 Disable X-window	122
10.1.2 Enable X-window.....	122
10.2 ScreenShot Support	122
10.3 WebCAM Support	123
10.4 Touch Screen Support	123
10.5 Network Support.....	125
10.6 Audio Function	131
10.7 USB to RS-232 Support	132
10.8 Other Optional Function	132
Appendix A. Service Information	135
Internet Service :	135
Manual Revision :	135

1. Introduction

LinPAC-51XX is the new generation Linux-based PAC from ICP DAS and is equipped with a PXA270 CPU (520 MHz) running a Linux kernel 2.6.19 operating system, variant connectivity (VGA, USB, Ethernet, RS-232/485 and audio port) and contains an optional I/O expansion board that can be used for implementing various I/O functions, such as D/I, D/O, A/D, D/A, Timer/Counter, UART, flash memory, etc.

The LinPAC-51XX had the advantages of good control system. These advantages include: stability, small core size, I/O expansion board optional, support for Web services (Web/FTP/Telnet/SSH server), support for multiple development environments (LinPAC SDK for Linux and Windows environment using the GNU C language, JAVA, GUI software), etc. They give you all of the best features of both traditional PLCs and Linux capable PCs. That's the most powerful and flexible embedded control system.

Compared to the first generation LinCon-8000, it not only improves the CPU performance (from 206 MHz to 520 MHz) and upgraded OS (from Linux kernel 2.4 to Linux kernel 2.6), but also adds many reliability features, such as plam-sized, dual LAN, audio ports, I/O expansion board optional, etc. That's the most powerful control systems available.

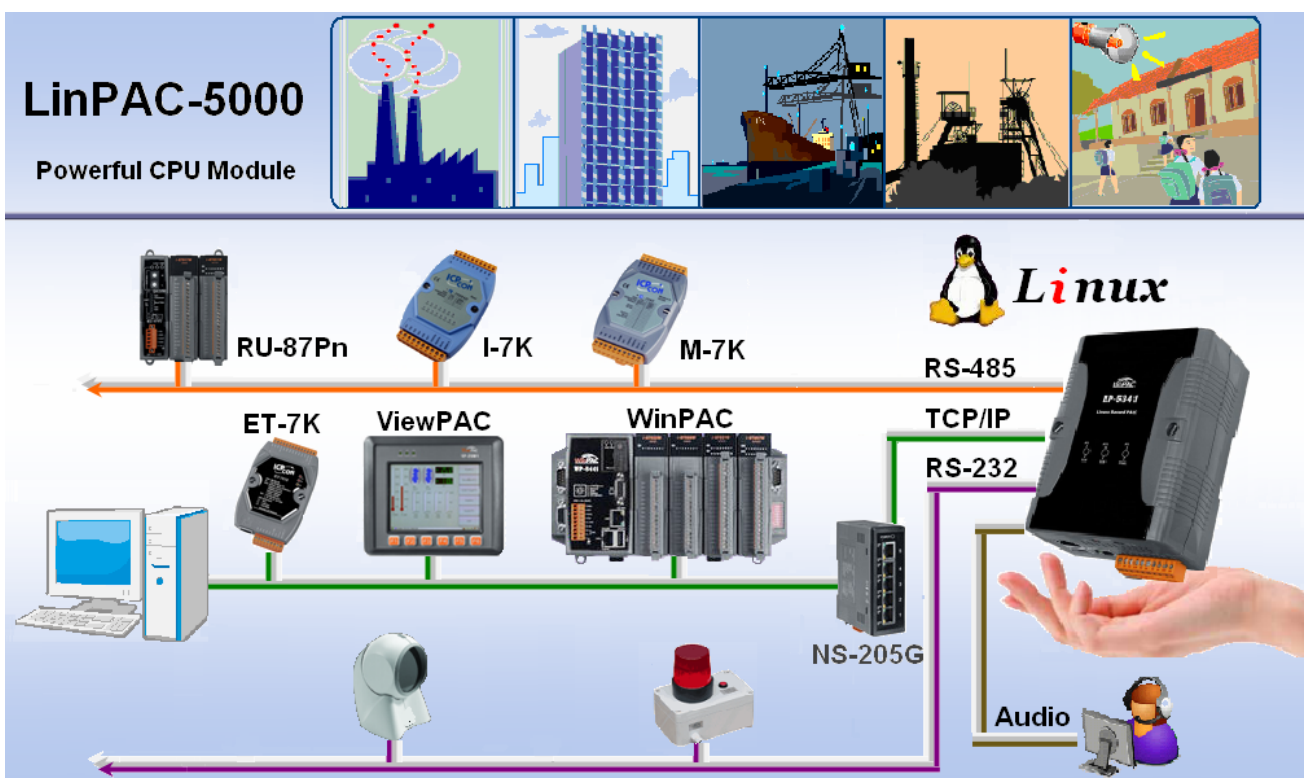

ICP DAS provides the library file – **libi8k.a** which includes all the functions from the I-7000/8000/87000 series modules which are used in the LinPAC-51XX Embedded Controller. The libi8k.a is designed specially for the high profile I-7000/8000/87000 series modules on the Linux platform for use in the LinPAC-51XX. Users can easily develop applications in the LinPAC-51XX by using either C or Java Language and the .NET applications will also be supported in the future. The various functions of the libi8k.a are divided into the sub-group functions for ease of use within the different applications. The powerful functions of the LinPAC-51XX embedded controller are depicted in figure 1-1, which includes a **VGA, USB (Card Reader, Camera ...), Mouse, Keyboard, microSD card, Series ports (RS-232/485), Ethernet (Hub...), etc.** in the picture. Presently, HTTP, FTP, Telnet, SSH and SFTP Servers are built in and users can transfer files or use remote control with the LinPAC-51XX more conveniently. In network communication, **wireless, Bluetooth** transfer and **Modem, GPRS, ADSL and Firewall** are also supported. Fig.1 illustrates hardware architecture of the LinPAC-51XX.

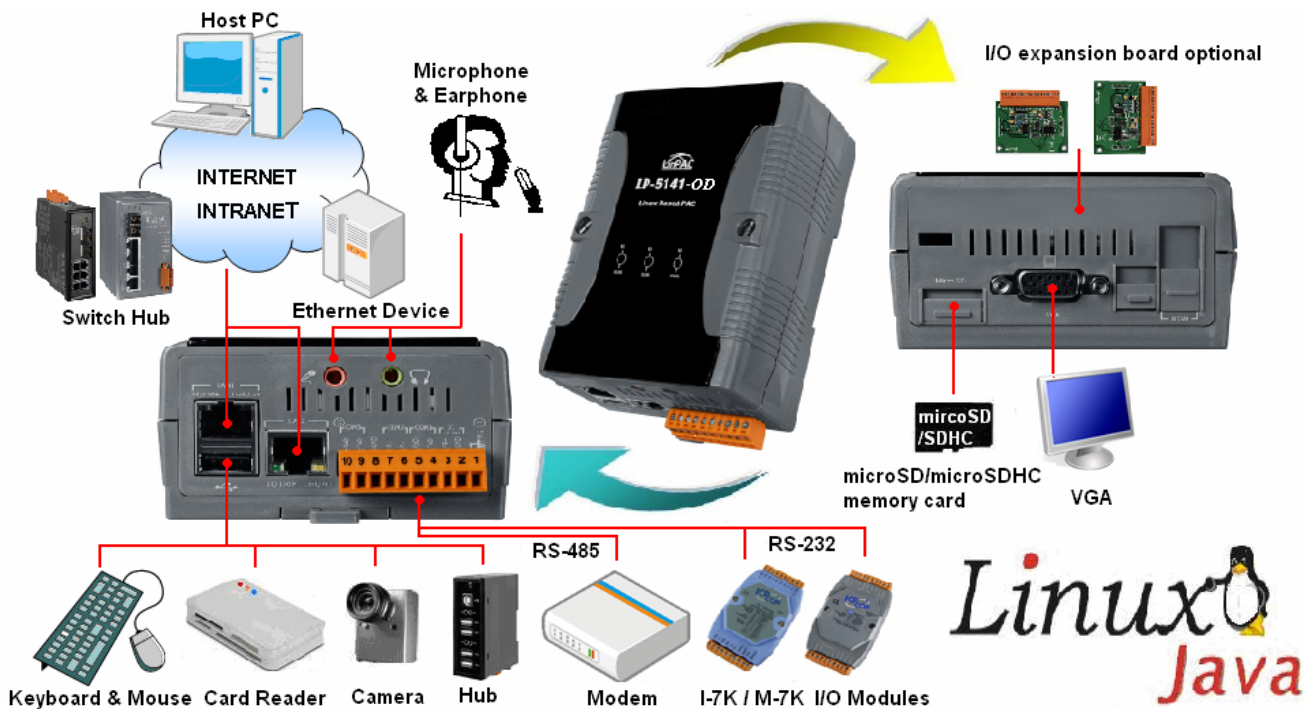

Fig. 1-1

2. Installation of LinPAC-51XX SDK

“LinPAC-51XX SDK” consists of the following major items.

- LinPAC SDK library files
- LinPAC SDK include files
- Demo files
- GNU ToolChain

From <ftp://ftp.icpdas.com/pub/cd/linpac/napdos/lp-5000/lp-51xx> users can download the latest version of LinPAC-51XX SDK (hereinafter referred to as LP-51xx). Then follows below steps to install the development toolkit provided by ICP DAS for the application development of the LP-51XX embedded controller platform easily.

2.1 Quick Installation of LinPAC-51XX SDK

(1) Quick Installation Guide for Windows

1. Please insert the installation CD into your CD-ROM driver.
2. Run the “lp51xx_sdk_for_windows.exe” file under the folder
\\napdos\lp-5000\lp-51xx\lp-513x\SDK\. Then click on the “Next” button, refer to Fig. 2-1.
3. Choose the option of “I accept the agreement” and click the “next” button, refer to Fig. 2-2 below.

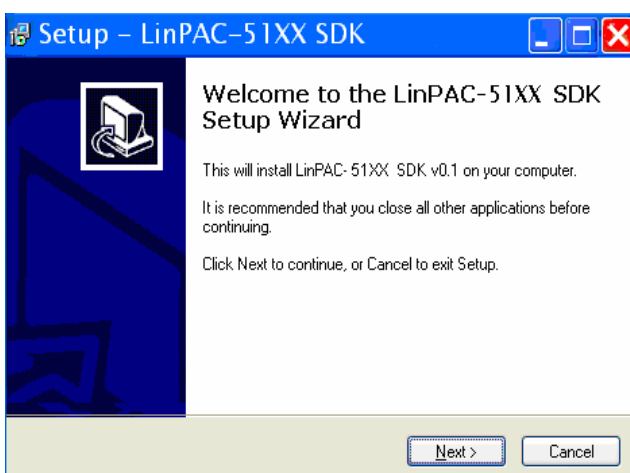

Fig. 2 -1

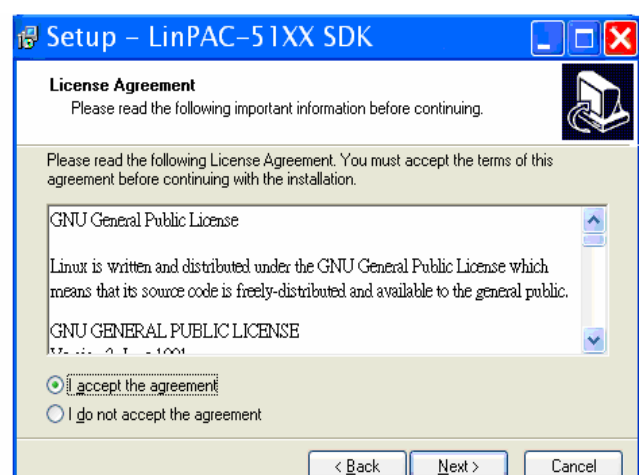

Fig. 2-2

4. To starting install the LP-51XX SDK, refer to Fig 2-3.
5. After successfully installing the software, please click on the “Finish” button to finish the development toolkit installation, refer to Fig. 2-4.

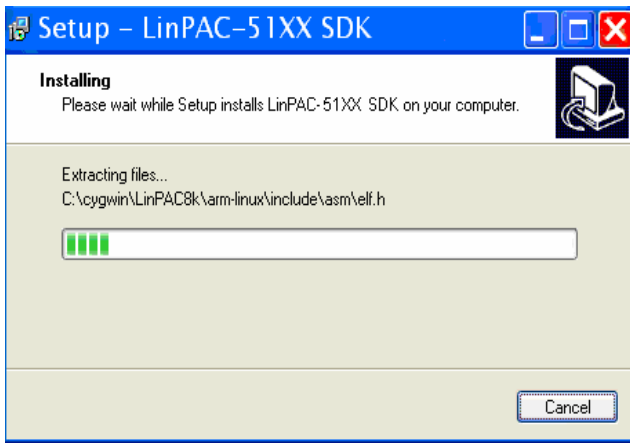

Fig. 2-3

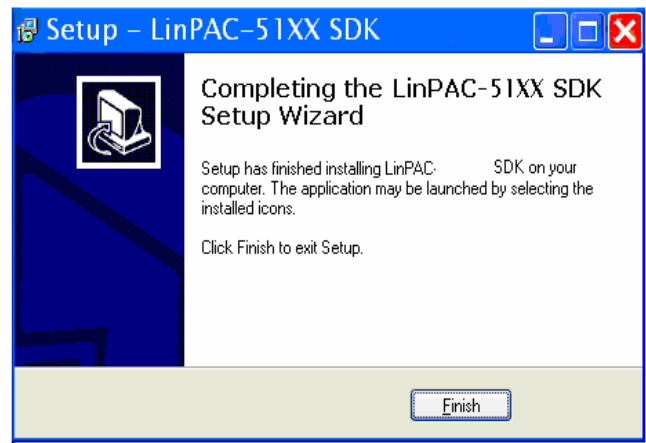

Fig. 2-4

6. Open the “**C:\cygwin\LinCon8k**” folder and see the content. Refer to Fig 2-5.

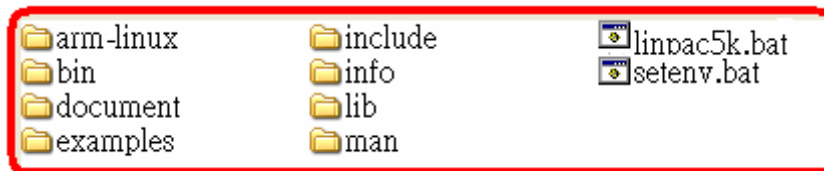

Fig. 2-5

7. Start using the “LinPAC-51XX Build Environment” by double clicking the shortcut for the “**LinPAC-51XX Build Environment**” on the desktop or by clicking through “Start ”> “Programs ”> “ICPDAS ”> “LinPAC-51XX SDK ”> “LinPAC-51XX Build Environment ” icon. Then a special DOSBOX will be displayed in which we can compile applications for the LinPAC-51XX. Refer to Fig. 2-6.



Fig. 2-6

Once your Installation is complete, you can find the files for the library and demo in the following paths.

The Libi8k.a and libxwboard.a path is “**C:\cygwin\LinCon8k\lib**”.

The include files path is “**C:\cygwin\LinCon8k\include**”

The demo path is “**C:\cygwin\LinCon8k\examples**”

(2) Quick Installation Guide for Linux

1. Before you install LP-51XX SDK, you must complete several tasks as the root user by 'sudo' or 'su' command.
2. Download the "lp51xx_sdk_for_linux.tar.bz2" file from the folder \napdos\lp-5000\lp-51xx\lp-513x\SDK\.

3. Enter the following commands to extract the file:

```
$ bzip2 -d lp51xx_sdk_for_linux.tar.bz2
```

```
$ tar jxvf lp51xx_sdk_for_linux.tar
```

```
[root@localhost /]# bzip2 -d lp51xx_sdk_for_linux.tar.bz2
[root@localhost /]#
[root@localhost /]# ls
ADK  etc      misc  opt    selinux  tmp      bin      home
    lp51xx_sdk_for_linux.tar  mnt      proc    srv      usr
boot lib      lost+found  net      root     sys      var
dev  media    nuwa  sbin   tftpboot
[root@localhost /]#
[root@localhost /]# tar jxvf lp51xx_sdk_for_linux.tar
...
lincon/i8k/opt/lib/libmenu.so
lincon/i8k/opt/lib/libgdk_pixbuf-2.0.1a
lincon/i8k/opt/lib/libiconv.so
lincon/i8k/opt/lib/libgobject-2.0.1a
lincon/i8k/opt/lib/libgdbm.a
lincon/i8k/opt/lib/libjpeg.so
lincon/i8k/opt/lib/libexpat.a
[root@localhost /]#
[root@localhost /]# ls
ADK  etc      media  nuwa    sbin      tftpboot  bin
home misc    opt    selinux tmp      boot      lib
    lp5k_sdk_for_linux.tar  mnt      proc      srv      usr
dev  lincon  lost+found  net      root     sys      var
[root@localhost /]#
```

4. To run the shell startup script and set the environment variables, enter the following command:

```
$ ./lincon/linpac.sh
```

2.2 The LinPAC-51XX SDK Introduction

In this section, we will discuss some techniques that are adopted in the LP-51XX. Through our detailed explanations, users can learn how to use the LP-51XX easily. LP-51XX SDK is based on cygwin and it is also a Linux-like environment for Windows. It still provides a powerful GCC cross-compiler and an IDE (Integrated Development Environment) for developing LP-51XX applications quickly. Therefore after you have written your applications, you can compile them through the LP-51XX SDK into executable files that can be run in your LP-51XX embedded controller.

2.2.1 Introduction to Cygwin

What is Cygwin ? Cygwin is a collection of free software tools originally developed by Cygnus Solutions to allow various versions of Microsoft Windows to act somewhat like a UNIX system. That is Cygwin is a Linux-like environment for Windows. It consists of two parts :

- (1) A DLL (cygwin1.dll) which acts as a Linux emulation layer providing substantial Linux API functionality.
- (2) A collection of tools, which provide users with the Linux look and feel.

2.2.2 Introduction to Cross-Compilation

What is Cross-Compilation? Generally, compiling a program takes place by running the compiler on the build platform. The compiled program will run on the target platform. Usually these two processes are on the same platform; if they are different, the process is called cross-compilation. That is the process that can compile source code on one platform to the executable files on other platforms. For example, you can compile source code in a x86 windows platform into an executable file that can run on an arm-linux platform if you use the cross-compiler - “**arm-linux-gcc**”.

So why do we use Cross-Compilation? In fact, Cross-Compilation is sometimes more involved and errors are easier to make than with normal compilation. Therefore it is often only employed if the target is not able to compile programs on its own or when we want to compile large programs that need more resources than the target can provide. For many embedded systems, cross-compilation is the only possible way.

2.2.3 Download the LinPAC-51XX SDK

(1) For Windows system : (Extract the .exe file into to the **C: driver.**)

lp51xx_sdk_for_windows.exe as below:

ftp://ftp.icpdas.com/pub/cd/linpac/napdos/lp-5000/lp-51xx/lp-513x/sdk/lp51xx_sdk_for_windows.exe

(2) For Linux system : (Extract the .bz2 file into to the **root(/) directory.**)

lp51xx_sdk_for_linux.tar.bz2 as below:

ftp://ftp.icpdas.com/pub/cd/linpac/napdos/lp-5000/lp-51xx/lp-514x/sdk/lp51xx_sdk_for_linux.tar.bz2

3.The Architecture of library in the LinPAC-51XX

The **libi8k.a** and **libxboard.a** are both a library file. The **libi8k.a** is designed for I7000/8000/87000 applications and **libxboard.a** is designed for I/O expansion boards. There are running in the LP-51XX Embedded Controller using the Linux OS. Users can apply it to develop their own applications **with GNU C language**. In order to assist users to build their project quickly, we provide many demo programs. Based on these demo programs, users can easily understand how to use these functions and develop their own applications within a short period of time.

The relationships among the **libi8k.a** and user's applications are depicted as Fig. 3-1 :

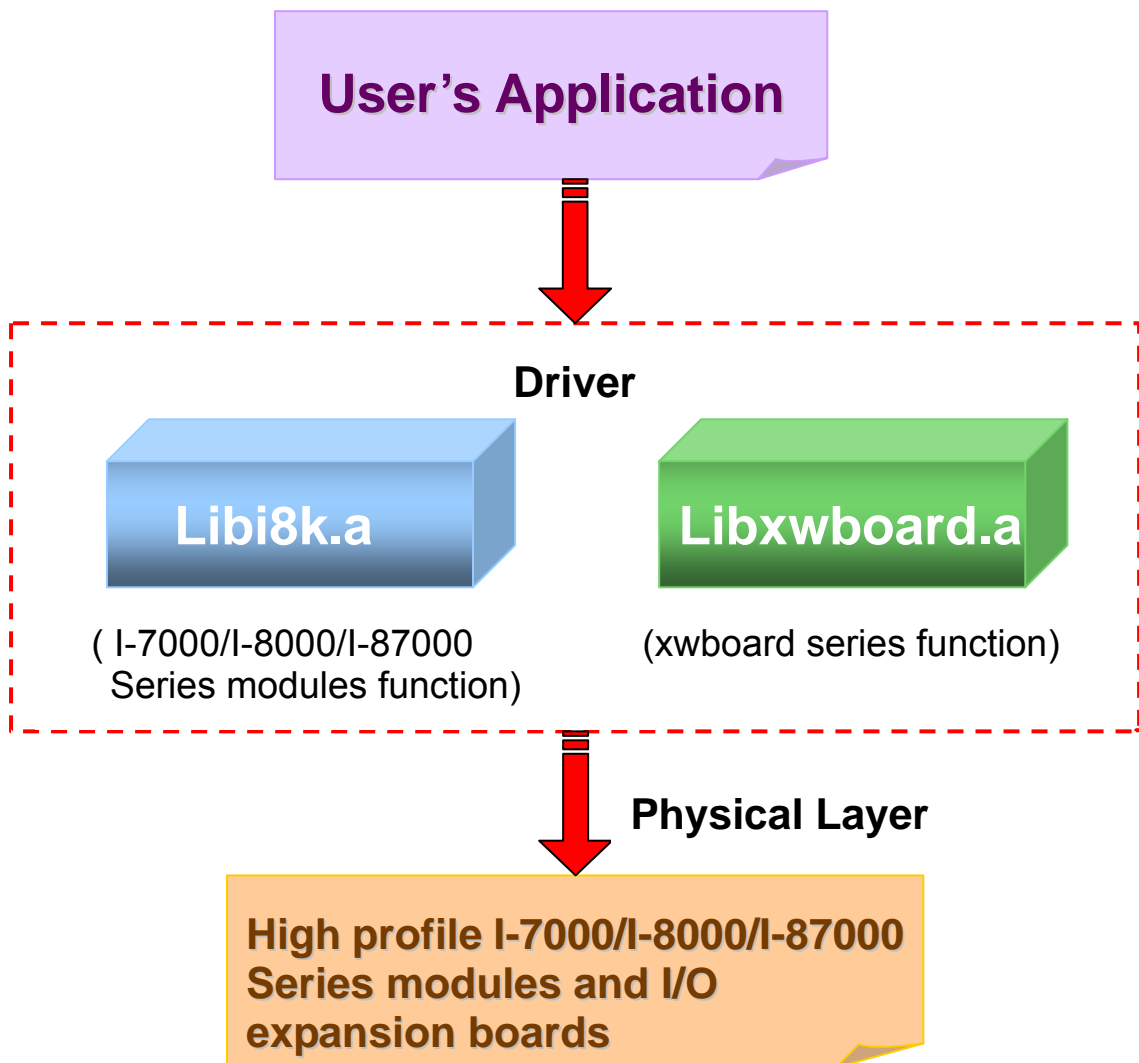

Fig. 3-1

Functions for LP-51XX Embedded Controller are divided into sub-groups for easy of use within the different applications :

1. System Information Functions
2. EEPROM Read/Write Functions
3. Watch Dog Timer Functions
4. Digital Input Functions
5. Digital Output Functions
6. Analog Input Functions
7. Analog Output Functions

The functions in the [libi8k.a](#) and [libxwboard.a](#) are specially designed for LP-51XX. For [libi8k.a](#) usage, users can easily find the functions they need for their applications from the descriptions in chapter 6 and in the demo programs provided in chapter 7. Another driver-[libxwboard.a](#), users can refer to [LP-51xx_xwboard_user_guide.pdf](#).

4. LinPAC-51XX System Settings

In this section, we will introduce how to setup the LP-51XX configuration. Let users can use the LP-51XX more easily.

4.1 Settings for the LinPAC-51XX Network

The LP-51XX network setting includes two ways. One is **DHCP** and the other is **“Assigned IP”**. DHCP is the default setting after the LP-51XX is produced and this way is easy for users. However, if your network system is without DHCP server, then users need to configure the network setting by using “Assigned IP”.

4.1.1 Setting the IP 、Netmask and Gateway

(1) Using DHCP :

Boot up LP-51XX and click the **“start/xterm”** to open a **“command Prompt”**. Type in **“vi /etc/network/interfaces”** to open the network setting file. Remove **“#”** in the dhcp block and add **“#”** in the Assign IP block. Then type **“:wq”** to save the setting. Type **“ifup eth0”** to make the setting work. (Refer to the Fig 4-1)

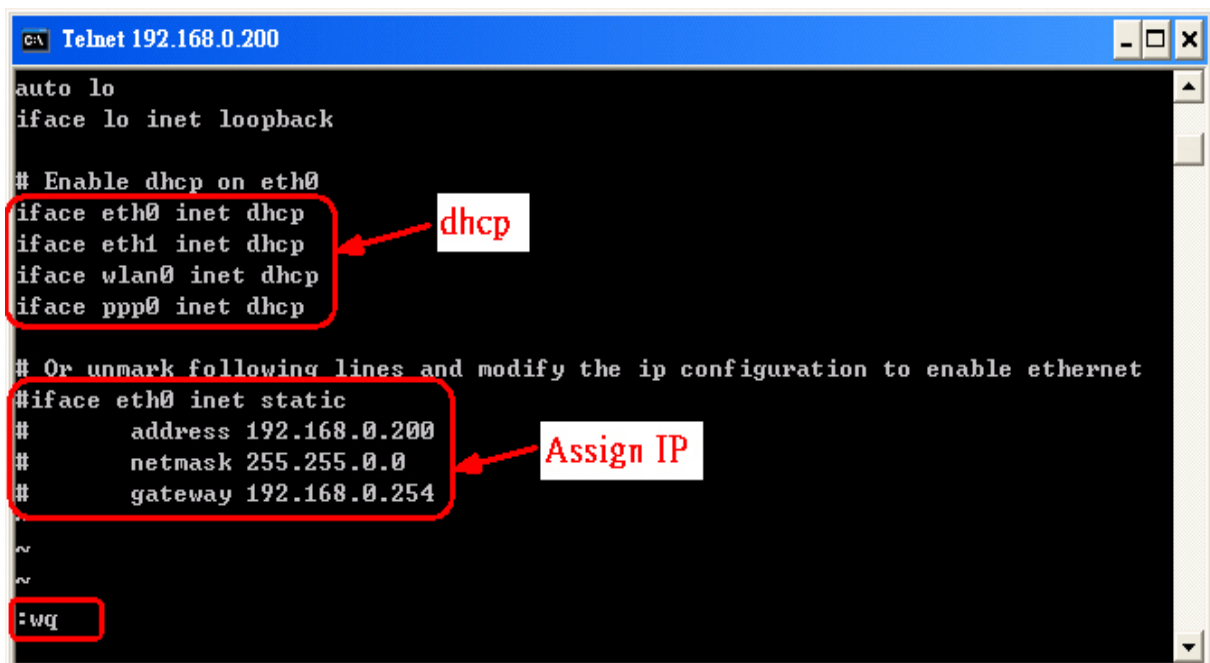

```
c:\ Telnet 192.168.0.200
auto lo
iface lo inet loopback

# Enable dhcp on eth0
iface eth0 inet dhcp
iface eth1 inet dhcp
iface wlan0 inet dhcp
iface ppp0 inet dhcp

# Or unmark following lines and modify the ip configuration to enable ethernet
#iface eth0 inet static
#   address 192.168.0.200
#   netmask 255.255.0.0
#   gateway 192.168.0.254

~
~
:wq
```

Fig 4-1

(2) Using “Assigned IP” :

Boot up LP-51XX and click the “ **start/xterm** ” to open a “command line”. Type in “ **vi /etc/network/interfaces** ” to open the network setting file. Remove “ # ” in the Assign IP block and add “ # ” in the dhcp block. Type ip 、 netmask and gateway you want in the Assign IP block. Then type “ **:wq** ” to save the setting. Type “ **ifup eth0** ” to make the setting work. (Refer to the Fig 4-2)

```
C:\ Telnet 192.168.0.200
auto lo
iface lo inet loopback
# Enable dhcp on eth0
#iface eth0 inet dhcp
#iface eth1 inet dhcp
#iface wlan0 inet dhcp
#iface ppp0 inet dhcp
# Or unmark following lines and modify the ip configuration to enable ethernet
iface eth0 inet static
address 192.168.0.200
netmask 255.255.0.0
gateway 192.168.0.254
~
~
:wq
```

Fig 4-2

After finish the LinPAC network setting, users can type “ **ifconfig** ” to see the network setting. (Refer to the Fig 4-3)

```
C:\ Telnet 192.168.0.200
# ifconfig
eth0: Link encap:Ethernet HWaddr 00:0D:E0:F0:00:C5
inet addr:192.168.0.200 Bcast:192.168.0.255 Mask:255.255.255.0
UP BROADCAST RUNNING MULTICAST MTU:1500 Metric:1
RX packets:3140 errors:0 dropped:0 overruns:0 frame:0
TX packets:428 errors:0 dropped:0 overruns:0 carrier:0
collisions:0 txqueuelen:100
RX bytes:391070 (381.9 KiB) TX bytes:0 (0.0 B)
Interrupt:2 Base address:0x5000

lo: Link encap:Local Loopback
inet addr:127.0.0.1 Mask:255.0.0.0
UP LOOPBACK RUNNING MTU:16436 Metric:1
RX packets:0 errors:0 dropped:0 overruns:0 frame:0
TX packets:0 errors:0 dropped:0 overruns:0 carrier:0
collisions:0 txqueuelen:0
RX bytes:0 (0.0 B) TX bytes:0 (0.0 B)
```

Fig 4-3

4.1.2 Setting of DNS

Boot up LP-51XX and click the “ **start/xterm** ” to open a “command line”. Type in “**vi /etc/resolv.conf**” to open the DNS setting file. Type “DNS server” in the “ **nameserver**” field. Then type “**:wq**” to save the setting. Type “**reboot**” to reboot the LP-51XX to make the setting work. (Refer to the Fig 4-4)



```
CA Telnet 192.168.0.200
search icpdas.com
nameserver 168.95.1.1
~
:wq
```

Fig 4-4

4.2 microSD Card Usage

Users can access the files of microSD card in the **/mnt/hda** directory (Refer to the Fig 4-5).

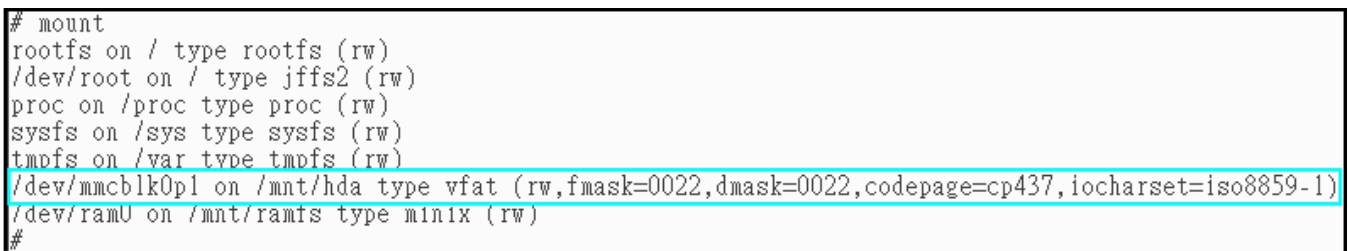

```
# mount
rootfs on / type rootfs (rw)
/dev/root on / type jffs2 (rw)
proc on /proc type proc (rw)
sysfs on /sys type sysfs (rw)
tmpfs on /var type tmpfs (rw)
/dev/mmcblk0p1 on /mnt/hda type vfat (rw, fmask=0022, dmask=0022, codepage=cp437, iocharset=iso8859-1)
/dev/ram0 on /mnt/ramfs type minix (rw)
#
```

Fig 4-5

When using the microSD card, pay attention to the following notes:

1. Umount the microSD card before unplugging it.
2. Please do not power off or reboot the LP-51XX while data is being written to or read from the microSD card.
3. The microSD memory must be formatted in the VFAT/EXT2/EXT3 file system.

4.2.1 Mount microSD Card

If want to use the microSD card, you can insert the microSD card into the socket in the LP-51XX (Refer to Fig. 1-3). It will be auto-mounted in the LP-51XX at boot time, and you can access the files of microSD card in the **/mnt/hda** directory.

If not, type in “**/etc/init.d/sd start**”, user can mount microSD card by manual.

4.2.2 Umount microSD Card

Before you want to pull out the microSD card from the LP-51XX, please type the following steps:

- (1) **/etc/init.d/apachect1 stop**
- (2) **/etc/init.d/startx stop**
- (3) **umount /mnt/hda**

Then you can pull out the microSD card safely to prevent the damage to microSD card.

4.2.3 Scan and repair microSD Card

The microSD card at boot will be named “ **/dev/mmcblk0p1** “. User could be umount microSD card first before scan or repair microSD card.

- ❑ **blockdev** : call block device ioctls from the command line
 - ex. `blockdev --report /dev/mmcblk0p1` (print a report for device)
 - `blockdev -v --getra --getbz /dev/mmcblk0p1` (get readhead and blocksize)
- ❑ **fsck.minix** : perform a consistency check for the Linux MINIX filesystem
 - ex. `fsck.minix -r /dev/mmcblk0p1` (performs interactive repairs)
 - `fsck.minix -s /dev/mmcblk0p1` (outputs super-block information)
- ❑ **fsck.vfat** : check and repair MS-DOS file systems
 - ex. `fsck.vfat -a /dev/mmcblk0p1` (automatically repair the file system)
 - `fsck.vfat -l /dev/mmcblk0p1` (list path names of files being processed)
- ❑ **mkfs** : build a Linux file system on a device, usually a hard disk partition.
 - ex. `mkfs -t vfat /dev/mmcblk0p1` (specifies the type of file system to be built)
 - `mkfs -c vfat /dev/mmcblk0p1`
(check the device for bad blocks before building the file system)
- ❑ **mkfs.minix** : make a MINIX filesystem
 - ex. `mkfs.minix /dev/mmcblk0p1` (create a Linux MINIX file-system)
 - `mkfs.minix -c /dev/mmcblk0p1`
(check the device for bad blocks before creating the file system)
- ❑ **mkfs.vfat** : make an MS-DOS filesystem
 - ex. `mkfs.vfat -A /dev/mmcblk0p1` (use Atari variation of the MS-DOS filesystem)
 - `mkfs.vfat -v /dev/mmcblk0p1` (verbose execution)

4.3 USB Storage Device Usage

Users need to mount the USB storage device to the LP-51XX, before they can access the USB storage device. This is because it will not auto-mount the USB storage device in the LP-51XX

4.3.1 Mount USB Storage Device

The steps are as follows :

- (1) Type “ **mkdir /mnt/usb** “ to build a usb directory.
- (2) Type “**mount /dev/sda1 /mnt/usb**“ to mount the USB storage device to the usb directory and type “ **ls /mnt/usb** ” to see the content of USB storage device.

4.3.2 Umount USB Storage Device

Before users pull out the USB storage device from the LP-51XX, users need to type the “ **umount /mnt/usb** “ command first. Then pull out the USB storage device to prevent any damage to usb storage device.

4.4 Adjust VGA Resolution

There are two modes -- **640x480**、**800x600** supported in the LinPAC VGA resolution and the **default setting is 800x600**. If users want to change the VGA resolution. Please follow below steps :

- (1) Type “ **vi /etc/init.d/fbman** ” to open resolution setting file.
- (2) If users want to set the resolution to be 640x480. First, add “ **#** ” in the 800x600 column and then remove “ **#** ” in the 640x480 column. Type “ **:wq** ” to save the setting. (Refer to Fig 4-6)

❑ Open the file : /etc/init.d/fbman, user will see the following lines:

```
#/usr/sbin/fbset -n 640x480-60
```

```
/usr/sbin/fbset -n 800x600-70
```

It means that the resolution setting is 800x600.

- If user want to change the setting to be **640*480**, please see the following setting result :

/usr/sbin/fbset -n 640x480-60

#!/usr/sbin/fbset -n 800x600-70

```
start)
    echo -n "Setting framebuffer ... "
    #/usr/bin/clear
    /usr/sbin/fbset -n 640x480-60
    #/usr/sbin/fbset -n 800x600-70
    EXITCODE=U
    ;;
stop)
    echo -n "Restore framebuffer ... "
    echo "done."
    EXITCODE=0
    ;;
restart)
    $0 stop
    $0 start
    EXITCODE=$?
    ;;
*)
    usage
    ;;
esac
:wq
```

Fig 4-6

- (3) Type “ **reboot** “ to reboot LP-51XX, then the setting will work.

```
# fbset
mode "640x480-60"
    # D: 26.000 MHz, H: 31.401 kHz, V: 59.926 Hz
    geometry 640 480 640 480 16
    timings 38461 78 46 22 10 64 12
    accel false
    rgba 5/11,6/5,5/0,0/0
endmode
#
```

4.5 Running applications automatically at boot time

A “run level” determines which programs are executed at system startup. Run level **2** is the default run level of LP-51XX. The contents of run level are in the /etc/init.d directory that directory contains the scripts executed at boot time. These scripts are referenced by symbolic links in the **/etc/rc2.d**.

These links are named S<2-digit-number><original-name>. The numbers determine the order in which the scripts are run, from 00 to 99 — the lower number would earlier executed. Scripts named with an **S** are called with start, and named with a **K** or **x** are called with stop.

4.5.1 Making program run at boot time

Making program run at boot time, you should create a startup script placed in `/etc/init.d` directory that runs the required commands for executed automatically at boot time and be symbolically linked to `/etc/rc2.d` directory.

The steps are as follows :

- (1) Type “ `vi /etc/init.d/hello` “ to edit a script that would like to executed program, filename is hello. Type “ `:wq` “ to save and quit the script. (Refer to the Fig 4-7)
- (2) Type “ `chmod 755 /etc/init.d/hello` “ to change authority.
- (3) Type “ `cd /etc/rc2.d` “ to into default run level.
- (4) Type ” `ln -s ../init.d/hello /etc/rc2.d/S85hello` “ to make a symbolic link into the script file and it will be executed automatically at boot time. (Refer to the Fig 4-8)

```

c:\ Telnet 10.0.9.1
#!/bin/sh ← For declaring
#
# ICPDAS LinCon-8000 daemon
#
# /etc/init.d/hello 0.1 2004/05/025 < moki matsushima >
usage()
{
    echo "Usage: $0 {start|stop|restart}"
}

EXITCODE=1
for x in "1" ; do
    if [ $# -lt 1 ] ; then usage ; break ; fi
    action=$1

    case "$action" in
    start)
        echo -n "Starting Hello services: "
        echo "Welcome to LinCon-8000!" ← Running at boot time.
        EXITCODE=0
        ;;
    stop)
        echo -n "Shutting down hello services: "
        echo "done."
        EXITCODE=0
        ;;
    restart)
        $0 stop
        $0 start
        EXITCODE=$?
        ;;
    *)
        usage
        ;;
    esac
done
:wq ← Save and Quit

```

Fig. 4-7

```

c> Telnet 10.0.9.1
#
# cd /etc/rc2.d ← run level
# ls
$09pppslip      $20ssh          $60snmp         $80hwclock      $99rmnologin   x$47ipsec
$10pcmcia       $40inetd        $70slot         $97fbman        x$04sd          x$72Ramdriver
$11ifupdown     $50apache       $71Serial       $98Xserver      x$20apmd
#
# ln -s ../init.d/hello /etc/rc2.d/S85hello ← Making a symbolic link
# ls -al
drwxr-xr-x  1 root  root           0 Jul 23 17:36 .
drwxr-xr-x  1 root  root           0 Jul 12 16:50 ..
lrwxrwxrwx  1 root  root          17 Sep 12  2005 $09pppslip -> ../init.d/pppslip
lrwxrwxrwx  1 root  root          16 Sep 12  2005 $10pcmcia -> ../init.d/pcmcia
lrwxrwxrwx  1 root  root          18 Sep 12  2005 $11ifupdown -> ../init.d/ifupdown
lrwxrwxrwx  1 root  root          13 Sep 12  2005 $20ssh -> ../init.d/ssh
lrwxrwxrwx  1 root  root          15 Sep 12  2005 $40inetd -> ../init.d/inetd
lrwxrwxrwx  1 root  root          19 Sep 12  2005 $50apache -> ../init.d/apachectl
lrwxrwxrwx  1 root  root          14 Sep 12  2005 $60snmp -> ../init.d/snmp
lrwxrwxrwx  1 root  root          14 Sep 12  2005 $70slot -> ../init.d/slot
lrwxrwxrwx  1 root  root          16 Sep 12  2005 $71Serial -> ../init.d/serial
lrwxrwxrwx  1 root  root          20 Sep 12  2005 $80hwclock -> ../init.d/hwclock.sh
lrwxrwxrwx  1 root  root          15 Jul 23 17:36 $85hello -> ../init.d/hello ← OK
lrwxrwxrwx  1 root  root          15 Sep 12  2005 $97fbman -> ../init.d/fbman
lrwxrwxrwx  1 root  root          16 Jul 23 12:36 $98Xserver -> ../init.d/startx
lrwxrwxrwx  1 root  root          19 Oct 30  2006 $99rmnologin -> ../init.d/rmnologin
lrwxrwxrwx  1 root  root          12 Sep 12  2005 x$04sd -> ../init.d/sd
lrwxrwxrwx  1 root  root          14 Sep 12  2005 x$20apmd -> ../init.d/apmd
lrwxrwxrwx  1 root  root          15 Sep 12  2005 x$47ipsec -> ../init.d/ipsec
lrwxrwxrwx  1 root  root          18 Sep 12  2005 x$72Ramdriver -> ../init.d/ramdrive
#

```

Fig. 4-8

4.5.2 Disabling program run at boot time

The steps are as follows :

- (1) Type “ **cd /etc/rc2.d** “ to into default run level.
- (2) Type “ **mv S85hello xS85hello** “ to rename the S85hello symbolic link for turn off running program automatically at boot time.

4.6 Automatic login

Log the specified user onto the console (normally /dev/tty1) when the system is first booted without prompting for a username or password using **mingetty** command.

The steps are as follows :

- (1) Login as root and edit **/etc/inittab**
- (2) Modify the entry for the first terminal— **tty1**

Below user can see the modified part of LP-51XX /etc/inittab file (Refer to the Fig 4-9), and it will autologins into the root account after reboot the LP-51XX.

```
# /sbin/getty invocations for the runlevels.
#
# The "id" field MUST be the same as the last
# characters of the device (after "tty").
#
# Format:
# <id>:<runlevels>:<action>:<process>
#
1:2345:respawn:/sbin/mingetty -noclear --autologin root tty1
#1:2345:respawn:/sbin/getty 38400 tty1
2:2345:respawn:/sbin/getty 38400 tty2
3:2345:respawn:/sbin/getty 38400 tty3
4:2345:respawn:/sbin/getty 38400 tty4
5:2345:respawn:/sbin/getty 38400 tty5
6:2345:respawn:/sbin/getty 38400 tty6
```

Fig. 4-9

5. Instructions for the LinPAC-51XX

In this section, some Linux instructions that are often used will be introduced. The use of these instructions in linux is very familiar with those in DOS and generally they are **used in lower case**.

5.1 Basic Linux Instructions

5.1.1 ls : list the file information —> (like dir in DOS)

Parameter :

- (1) -l : list detailed information of file (Example : ls -l)
- (2) -a : list all files including hidden files (Example : ls -a)
- (3) -t : list the files that are arranged by time(from new to old)

5.1.2 cd directory : Change directory —> (like cd in DOS)

Parameter :

- (1) .. : move to the upper directory (Example : cd ..)
- (2) ~ : move back to the root directory (Example : cd ~)
- (3) / : divided sign (for examples : cd /root/i8k)

5.1.3 mkdir : create the subdirectory —> (like md in DOS)

mkdir -parameter subdirectory

(Example : mkdir owner)

5.1.4 rmdir : delete(remove) the subdirectory and it must be empty —> (like rd in DOS)

rmdir -parameter subdirectory

(Example : rmdir owner)

5.1.5 rm : delete file or directory —> (like del or deltree in DOS)

rm -parameter file (or directory)

Parameter :

- (1) i : it will show the warning message when deleting (Example : rm -i test.exe)
- (2) r : delete directory despite that it isn't empty (Example : rm -r Test)
- (3) f : it will not show a warning message when deleting (Example : rm -f test.exe)

5.1.6 cp : copy file —> (like copy in DOS)

cp -parameter source file destination file

(Example : cp test.exe /root/Test/test.exe)

5.1.7 mv : move or rename file or directory —> (like move or ren in DOS)

mv -parameter source file (or directory) destination file (or directory)

(Example : mv test.exe test1.exe)

(Example : mv test.exe /root/Test)

5.1.8 pwd : show the current path

5.1.9 who : show the on-line users

5.1.10 chmod : change authority of file

chmod ??? file —> ??? means owner : group : all users

For example :

chmod 754 test.exe

7 5 4 —> 111(read, write, execute) 101(read, write, execute) 100(read, write, execute)

The first number 7 : **owner** can read and write and execute files

The second number 5 : **group** can only read and execute files

The third number 4 : **all users** can only read files

5.1.11 uname : show the version of linux

5.1.12 ps : show the procedures that execute now

5.1.13 ftp : transfer file

ftp IPAdress (Example : ftp 192.168.0.200 – > connet to ftp server)

! : exit FTP back to pc temporarily ; **exit** : back to ftp

bin : transfer files in “binary” mode

get : download file from LinPAC to PC (Ex : get /mnt/hda/test.exe c:/test.exe)

put : upload file from PC to LinPAC (Ex : put c:/test.exe /mnt/hda/test.exe)

bye : exit FTP

5.1.14 telnet : connect to other PC

telnet IPAdress (Example : telnet 192.168.0.200 – > remote control LinPAC-51XX)

5.1.15 date : show date and time

5.1.16 netstat : show the state of network

Parameter [-a] : list all states (Example : netstat -a)

5.1.17 ifconfig : show the ip and network mask (like ipconfig in DOS)

5.1.18 ping : check to see if the host in the network is alive

ping IPAdress (Example : ping 192.168.0.1)

5.1.19 clear : clear the screen

5.1.20 passwd : change the password

5.1.21 reboot : reboot the LinPAC

5.2 General GCC Instructions

GCC is a cross-compiler provided by GNU and it can compile source code written by ANSI C or by Traditional C into executable files. The executable file compiled by GCC can run in different OSs and in different Hardware systems. Therefore GCC is very popular within the Unix system which is a large part of why its popularity is growing so well. Furthermore it is free, and therefore can be downloaded via your network with ease.

First, Fig. 5-1 illustrates the compilation procedure within Linux :

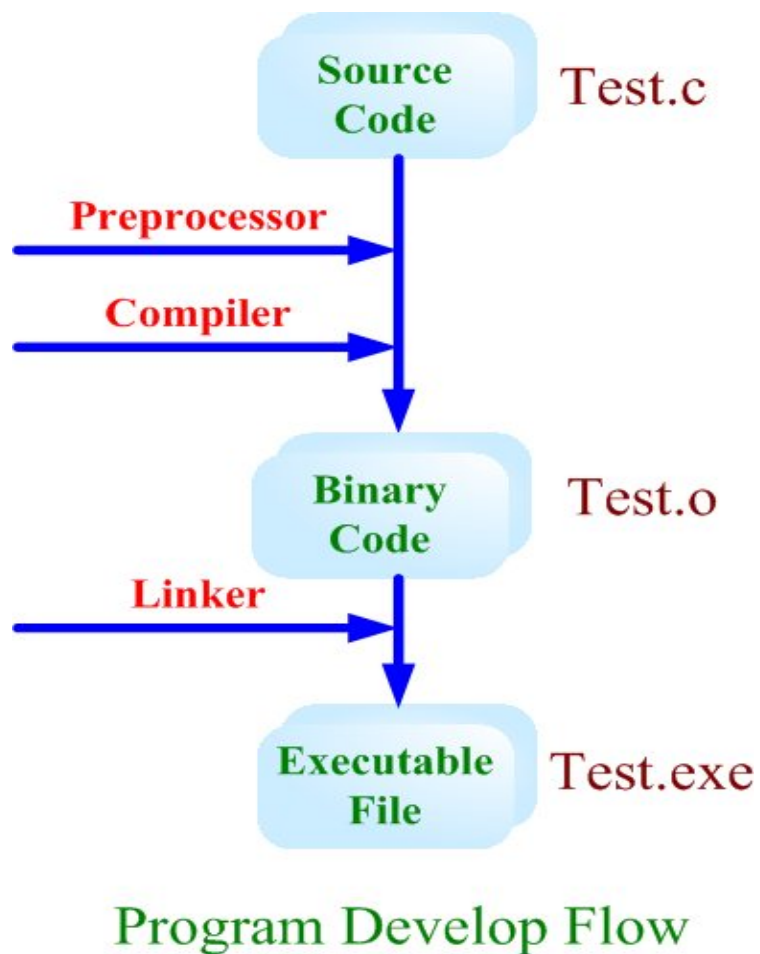

Fig. 5-1

Second, we will list some GCC instructions to let users compile *.c to *.exe smoothly and to explain the parameters for GCC in its compilation process.

5.2.1 Compile without linking the LinPAC-51XX library

(1) Purpose : *.c to *.exe

Command : arm-linux-gcc -o target source.c

Parameter :

-o target : assign the name of output file

source.c : source code of C

Example : arm-linux-gcc -o helloworld.exe helloworld.c

Output File : helloworld.exe

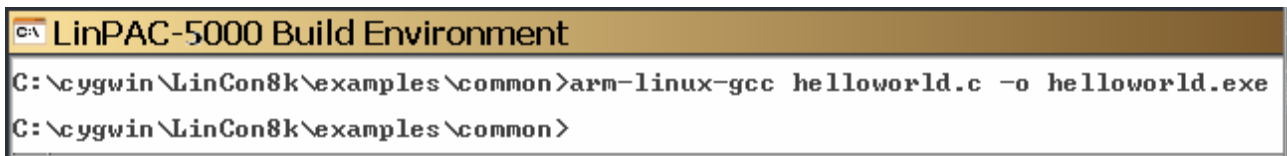

```
C:\ LinPAC-5000 Build Environment
C:\cygwin\LinCon8k\examples\common>arm-linux-gcc helloworld.c -o helloworld.exe
C:\cygwin\LinCon8k\examples\common>
```

5.2.2 Compile with linking the LinPAC-51XX library (libi8k.a)

(1) Purpose : *.c to *.o

Command : arm-linux-gcc -lincludeDIR -lm -c -o target source.c library

Parameter :

-lincludeDir : the path of include files

-lm : include math library (libm.a)

-c : just compile *.c to *.o (object file)

-o target : assign the name of output file

source.c : source code of C

library : the path of library

Example : arm-linux-gcc -I. -I./include -lm -c -o test.o test.c ./lib/libi8k.a

Output File : test.o

(2) Purpose : *.o to *.exe

Command : arm-linux-gcc -lincludeDIR -lm -o target source.o library

Parameter :

-lincludeDir : the path of include files

-lm : include math library (libm.a)

-o target : assign the name of output file

source.o : object file

library : the path of library

Example : `arm-linux-gcc -I. -I./include -lm -o test.exe test.o ../lib/libi8k.a`

Output File : test.exe

(3) Purpose : *.c to *.exe

Command : `arm-linux-gcc -lincludeDIR -lm -o target source.c library`

Parameter :

-lincludeDir : the path of include files

-lm : include math library (libm.a)

-o target : assign the name of output file

source.c : source code of C

library : the path of library

Example : `arm-linux-gcc -I. -I./include -lm -o test.exe test.c ../lib/libi8k.a`

Output File : test.exe

5.3 A Simple Example – Helloworld.c

In this section, we will introduce how to compile the helloworld.c to helloworld.exe and transfer the helloworld.exe to the LinPAC-51XX by using FTP. Finally executes this file via the Telnet Server on the LinPAC-51XX. These steps can be accomplished in one pc without another monitor. In this example, no ICP DAS modules are used. If you want to use the modules of ICP DAS to control your system, you can refer to demo in the chapter 7.

These processes can be divided into three steps and that are given as below :

STEP 1 : (Compile helloworld.c to helloworld.exe)

(1) Open LinPAC-51XX SDK (refer to step 8 in section 2.1) and type

“ **cd examples/common** ” to change the path to

C:/cygwin/LinCon8k/examples/common. Type “**dir/w**” and you can see the helloworld.c file. (refer to Fig.5-2)

```

C:\ LinPAC-51XX Build Environment
C:\cygwin\LinCon8k>cd examples\common
C:\cygwin\LinCon8k\examples\common>dir/w
Volume in drive C has no label.
Volume Serial Number is 649C-FEE2

C:\cygwin\LinCon8k\examples\common
[.]          [..]
back_plane_id.exe    dip_switch.c        dip_switch.exe      back_plane_id.c
echosvr.exe          eeprom.c            eeprom.exe          echosvr.c
getdo_rb.exe         [getexai]           getexai.c           getdo_rb.c
getexai.rar          getexdi.c           getexdi.exe         getexai.exe
getlist.exe          getport.c           getport.exe         getlist.c
getreceive.exe       getsendreceive.c    getsendreceive.exe  getreceive.c
getsendreceive_bin.exe helloworld.c        getsendreceive_bin.c led.c
led.exe              port.c              port.exe            read_sn-test.c
read_sn-test.exe     read_sn.c           read_sn.exe         rotary_id.c
rotary_id.exe        send_receive.c      send_receive.exe    serial_test.c
serial_test.exe      setdo_bw-ok.c      setdo_bw.c          setdo_bw.exe
setexao.c            setexao.exe         setexdo.c           setexdo.exe
setport.c            setport.exe         setsend.c           setsend.exe
slot_count.c         slot_count.exe      wdt_safe_value.c   wdt_safe_value.exe
sramok.exe           timer.c             wdt.c               wdt.exe
timer2.exe           uart.c              sram-read.c         sram-read.exe
timer.exe            timer2.c            sram.c              sram.exe

```

Fig. 5-2

(2) Type in “**arm-linux-gcc -o helloworld.exe helloworld.c**” to compile helloworld.c into helloworld.exe. Then type “**dir/w**” to see the helloworld.exe file. (refer to Fig.5-3)

```

C:\ LinPAC-51XX Build Environment
C:\cygwin\LinCon8k\examples\common>arm-linux-gcc -o helloworld.exe helloworld.c
C:\cygwin\LinCon8k\examples\common>dir/w
Volume in drive C has no label.
Volume Serial Number is 649C-FEE2

C:\cygwin\LinCon8k\examples\common
[.]          [..]
back_plane_id.c      back_plane_id.exe
echosvr.c            echosvr.exe
getdo_rb.c           getdo_rb.exe
getexdi.c            getexdi.exe
getport.c            getport.exe
getsendreceive.c     getsendreceive.exe
helloworld.c         helloworld.exe
port.c               port.exe
rotary_id.c          rotary_id.exe
setdo_bw.c           setdo_bw.exe
setexdo.c            setexdo.exe
setsend.c            setsend.exe
timer.c              timer.exe
uart.c               uart.exe
wdt_safe_value.c     wdt_safe_value.exe
56 File(s)           2,257,242 bytes
2 Dir(s)             98,268,422,144 bytes free

```

Fig. 5-3

STEP 2 : (Transfer helloworld.exe to the LinPAC-51XX)

There are two methods for transferring files to the LinPAC-51XX :

< Method one > By Using the “DOS Command Prompt” :

- (1) Open a “DOS Command Prompt” and type in the ftp IPAddress of the LinPAC-51XX (Example : **ftp 192.168.0.200**) to connect to the FTP Server on the LinPAC-51XX. Then type the **User_Name** and **Password (“ root ” is the default value.)** to accomplish the connection from the PC to the LinPAC-51XX.
- (2) Before transferring your files to the LinPAC-51XX, type in the “**bin**” command to make the file transfer to the LinPAC-51XX **in binary mode**. (refer to Fig.5-4)

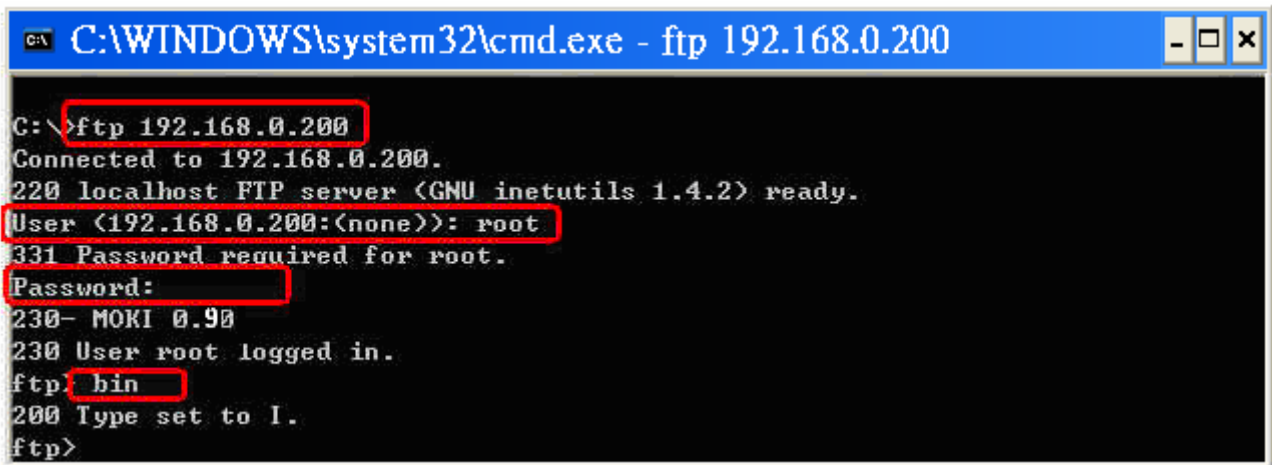

```
C:\WINDOWS\system32\cmd.exe - ftp 192.168.0.200
C:\>ftp 192.168.0.200
Connected to 192.168.0.200.
220 localhost FTP server (GNU inetutils 1.4.2) ready.
User (192.168.0.200:(none)): root
331 Password required for root.
Password:
230- MOKI 0.90
230 User root logged in.
ftp: bin
200 Type set to I.
ftp>
```

Fig.5-4

- (3) Type in “ **put C:/cygwin/LinCon8k/examples/common/helloworld.exe helloworld.exe** ” to transfer helloworld.exe to the LinPAC-51XX. If it shows the message of “ **Transfer complete** ”, then the whole transferring process has been accomplished. If you need to disconnect from the LinPAC-51XX, type in the “ **bye** ” command to return to the PC console. (refer to Fig.5-5).

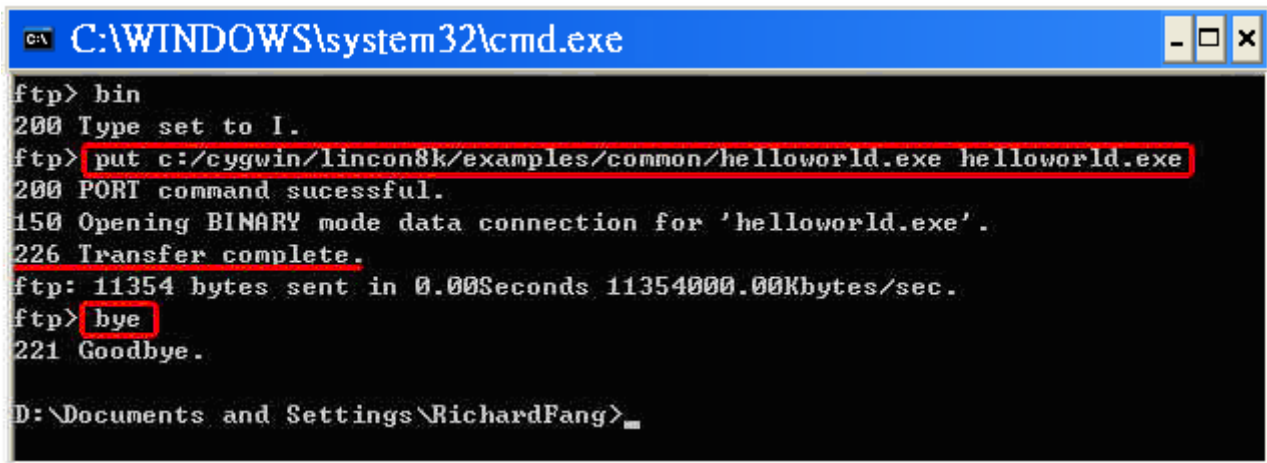

```
C:\WINDOWS\system32\cmd.exe
ftp> bin
200 Type set to I.
ftp> put c:/cygwin/lincon8k/examples/common/helloworld.exe helloworld.exe
200 PORT command successful.
150 Opening BINARY mode data connection for 'helloworld.exe'.
226 Transfer complete.
ftp: 11354 bytes sent in 0.00Seconds 11354000.00Kbytes/sec.
ftp> bye
221 Goodbye.

D:\Documents and Settings\RichardFang>
```

Fig.5-5

< **Method two** > **By Using FTP Software** :

(1) Open the FTP Software and add a ftp site to the LinPAC-51XX. The **User_Name** and **Password** default value is “**root**”. Then click the “**Connect**” button to connect to the ftp server of the LinPAC-51XX. (refer to Fig.5-6).

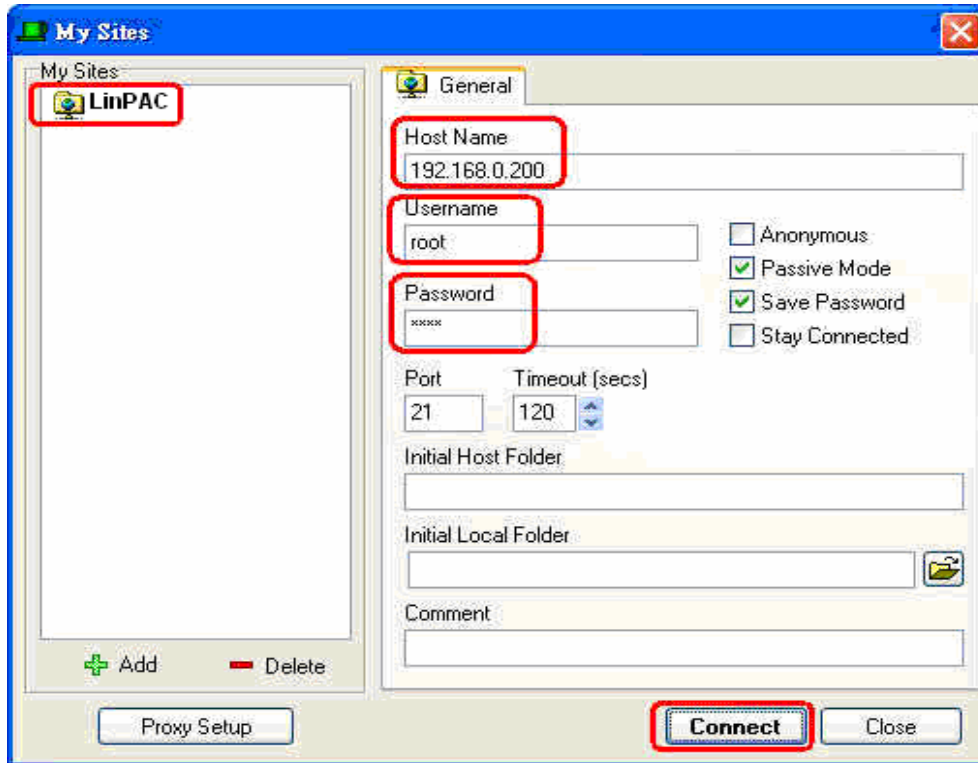

Fig.5-6

(2) Upload the file - **Helloworld.exe** to the LinPAC-51XX. (refer to Fig.5-7).

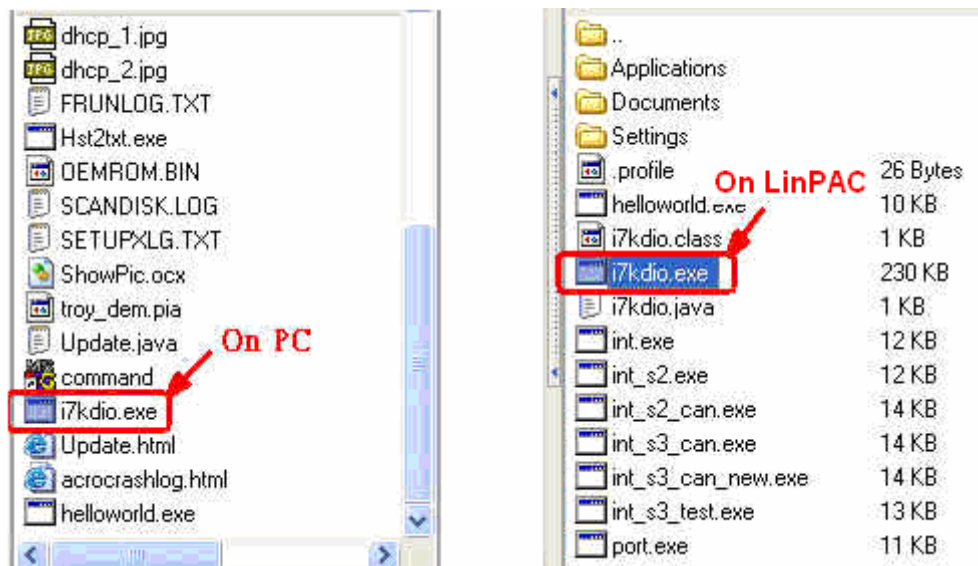

Fig.5-7

- (3) Choose helloworld.exe in the LinPAC-51XX and click the right button of mouse to choose the “ **Permissions** ” option. Then type 777 into the Numeric textbox. (refer to Fig.5-8 and Fig.5-9).

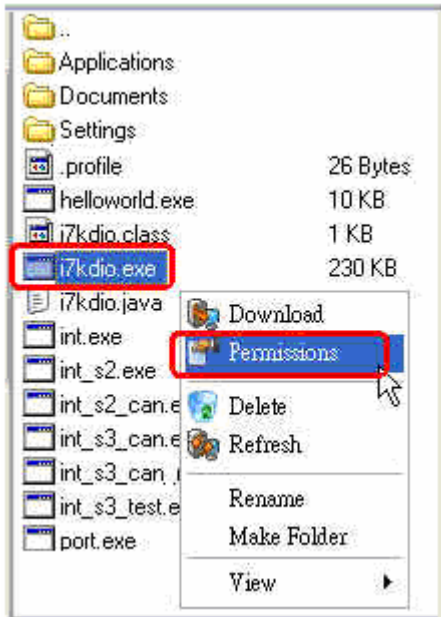

Fig.5-8

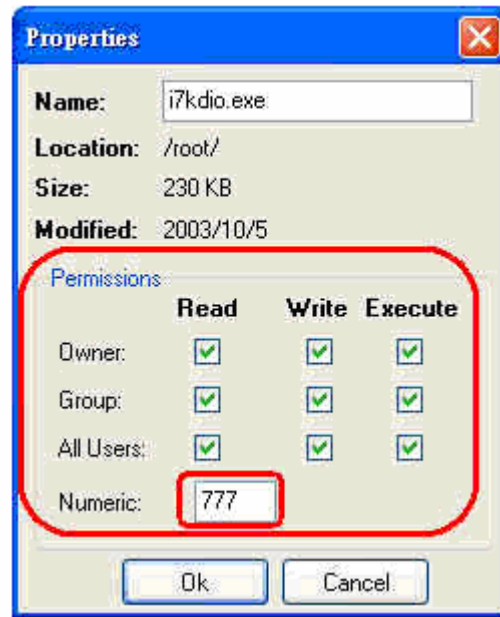

Fig.5-9

STEP 3 : (Telnet to the LinPAC-51XX and execute program)

- (1) Open a “ DOS Command Prompt ” and then type in the telnet IPAddress of the LinPAC-51XX (Example : **telnet 192.168.0.200**) to connect to the telnet server of the LinPAC-51XX. Then type the **User_Name** and **Password** (“ root ” is the default value.). If it shows the “ # ” prompt character, the process of connecting from your PC to the telnet server of the LinPAC-51XX is finished. (refer to Fig.5-10)

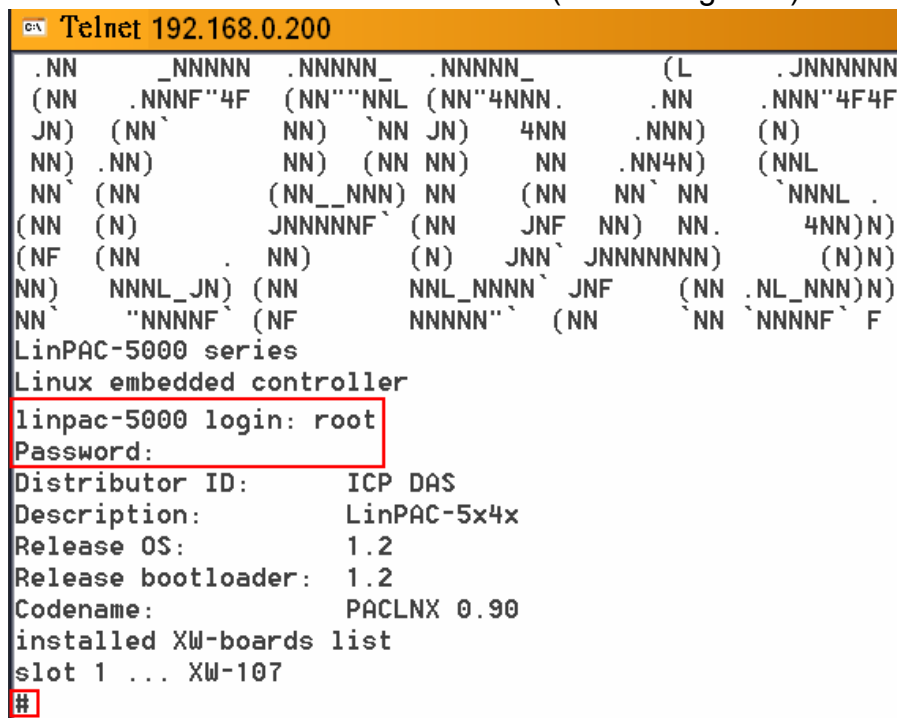

Fig.5-10

(2) Type in the “**ls -l**” command in order to list all the files in /root and to see the helloworld.exe file. Then type in the “**chmod 777 helloworld.exe**” command to change the authority of helloworld.exe and then type in the “**ls -l**” command again to see “helloworld.exe”. This means that the file is executable. Type in “**./helloworld.exe**” to execute the file and it will show “ Welcome to LinPAC-51XX ”. Then all the steps from compile, transfer to telnet to execute program will be completed. (refer to Fig.5-11)

```

Telnet 192.168.0.200
# chmod 777 helloworld.exe
# ls -l
-rwxrwxrwx 1 root  root  5243 Jun 30 14:52 helloworld.exe
# ./helloworld.exe
Hi ~ Welcome to LinPAC-5000
#
  
```

Fig.5-11

5.4 i-Talk Utility

The **i-Talk utility** provides **eleven instructions** that make it convenient for users to access the modules and hardware in the LinPAC-51XX and they are placed in the path — **/usr/local/bin**. Fig. 5-12 describes the functions of i-Talk utility.

No.	Instruction	Function Description
1	getport	Get port value by offset from a module
2	setport	Set port value by offset to a module
3	setsend	Send string from LinPAC-51XX COM port
4	getreceive	Receive string from LinPAC-51XX COM port
5	getsendreceive	Send/Receive string from LinPAC-51XX COM port
6	read_sn	Get Hardware Serial Number of LinPAC-51XX
7	getlist_xw	Get what's the xwboard plug-in LinPAC-51XX
8	setexdo	Set digital output value to xw-board and i-7k module
9	setexao	Set analog output value to xw-board and i-7k module
10	getexdi	Set digital input value to xw-board and i-7k module
11	getexai	Get analog input value to xw-board and i-7k module

Fig. 5-12

Users can also type in the instructions name and it will show the instructions usage.

6. LIBI8K.A

In this section, we will focus on examples for the description of and application of the functions found in the Libi8k.a. The Libi8k.a functions can be clarified into 3 groups which are listed in Fig. 6-1.

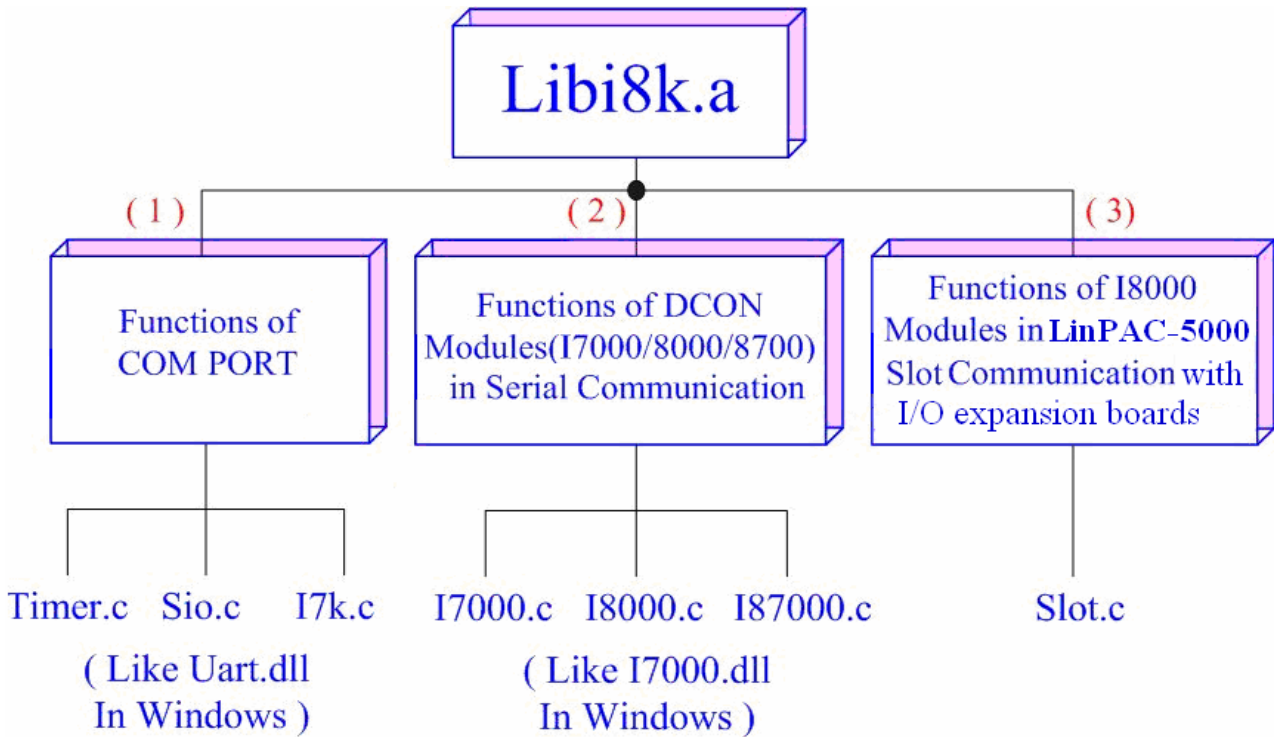

Structure of Libi8k.a

Fig. 6-1

Functions (1) and (2) in the Libi8k.a are the same as with the DCON.DLL Driver (including Uart.dll and I7000.dll) as used in the DCON modules (High profile I-7000/I-8000 /I-87000 in serial communication). You can refer to the DCON.DLL Driver manual which includes the functions on how to use DCON modules (<http://www.icpdas.com/products/>). The DCON.DLL Driver has already been wrapped into the Libi8k.a. Functions (3) of the Libi8k.a consist of the most important functions as they are specially designed for I-8000 modules in the LinPAC-51XX slots. They are different from functions (1) and (2) because the communication of I-8000 modules in the LinPAC-51XX slots are parallel and not serial. Therefore ICP DAS rewrote I8000.c to Slot.c especially for I-8000 modules in the LinPAC-51XX slots.

Here we will introduce all the functions for slot.c and they can be divided into eight parts for ease of use.

1. System Information Functions;
2. Watch Dog Timer Functions;
3. EEPROM Read/Write Functions;
4. Digital Input/Output Functions;
5. Analog Input Functions;
6. Analog Output Functions;

When using the development tools to develop applications, the **msw.h** file must be included in front of the source program, and when building applications, **libi8k.a** must be linked. If you want to control ICP DAS I/O remote modules like i7k, i8k and i87k **through COM1 or COM2 or COM3 of the LinPAC-51XX**, the functions are all the same with DCON DLL.

6.1 System Information Functions

■ Open_Slot

Description:

This function is used to open and initiate a specified slot in the LinPAC-51XX. The I/O expansion board(http://www.icpdas.com/products/PAC/up-5000/XW-board_Selection_Guide.htm) in the LinPAC-51XX will use this function. For example, if you want to send or receive data from a specified slot, this function must be called first. Then the other functions can be used later.

Syntax:

[C]
<code>int Open_Slot(int slot)</code>

Parameter:

slot : [Input] Specify the slot number in which the I/O module is plugged into.
(Range of slot: 0~1)

Return Value:

0 is for Success
Not 0 is for Failure

Example:

```
Int slot=1;  
Open_Slot(slot);  
// The first slot in the LinPAC-51XX will be open and initiated, and only for XW-board.
```

Remark:

■ Close_Slot

Description:

If you have used the function of `Open_Slot()` to open the specified slot in the LinPAC-51XX, you need to use the `Close_Slot()` function to close the specified slot in the LinPAC-51XX. The I/O expansion board in the LinPAC-51XX will use this function. For example, once you have finished sending or receiving data from a specified slot, this function would then need to be called.

Syntax:

```
void Close_Slot(int slot) [ C ]
```

Parameter:

slot : [Input] Specify the slot number in which the I/O module is plugged into.
(Range of slot: 0~1)

Return Value:

None

Example:

```
int slot=1;
Close_Slot(slot);
// The first slot in the LinPAC-51XX will be closed, and only for XW-board.
```

Remark:

■ Open_SlotAll

Description:

This function is used to open and initiate **all slots** in the LinPAC-51XX. For example, if you want to send or receive data from multiple slots, you can call this function to simplify your program. Then you can use the other functions later.

Syntax:

[C]
<code>int Open_SlotAll(void)</code>

Parameter:

None

Return Value:

0 is for Success

Not 0 is for Failure

Example:

```
Open_SlotAll();
```

```
// All slots in the LinPAC-51XX will be open and initiated.
```

Remark:

■ Close_SlotAll

Description:

If you have used the function `Open_SlotAll()` to open all the slots in the LinPAC-51XX, you can use the `Close_SlotAll()` function to close all the slots in the LinPAC-51XX. For example, once you are finish sending or receiving data from many slots, this function can be called to close all the slots rapidly.

Syntax:

```
void Close_SlotAll(void) [ C ]
```

Parameter:

None

Return Value:

None

Example:

```
Close_SlotAll();  
// All slots in the LinPAC-51XX will be closed.
```

Remark:

■ Open_Com

Description:

This function is used to configure and open the COM port. It must be **called once before** sending/receiving command through COM port. For example, if you want to send or receive data from a specified COM port, you need to call this function first. Then you can use the other series functions.

Syntax:

[C]

```
WORD Open_Com(char port, DWORD baudrate, char cData, char cParity, char cStop)
```

Parameter:

port : [Input] COM1, COM2, COM3..., COM255.
baudrate: [Input] 1200/2400/4800/9600/19200/38400/57600/115200
cDate : [Input] Data5Bit, Data6Bit, Dat7Bit, Data8Bit
cParity : [Input] NonParity, OddParity, EvenParity
cStop : [Input] OneStopBit, TwoStopBit

Return Value:

0 is for Success
Not 0 is for Failure

Example:

```
Open_Com(COM3, 9600, Data8Bit, NonParity, OneStopBit);
```

Remark:

■ Close_Com

Description:

This function is used to closes and releases the resources of the COM port computer recourse. And it must be **called before exiting the application program**. The Open_Com will return error message if the program exit without calling Close_Com function.

Syntax:

[C]
BOOL Close_Com(char port)

Parameter:

port : [Input] COM1,COM2, COM3...COM255.

Return Value:

None

Example:

```
Close_Com (COM3);
```

Remark:

■ Send_Receive_Cmd

Description:

This function is used to send a command string to RS-485 network and receive the response from RS-485 network. If the wChkSum=1, this function automatically adds the two checksum bytes into the command string and also check the checksum status when receiving response from the modules. Note that the end of sending string is added [0x0D] to mean the termination of every command.

Syntax:

```
[ C ]  
WORD Send_Receive_Cmd (char port, char szCmd[ ], char szResult[ ],  
WORD wTimeOut, WORD wChksum, WORD *wT)
```

Parameter:

port : [Input] 1=COM1, 2=COM2, 3=COM3..., 255=COM255.
szCmd: [Input] Sending command string
szResult : [Input] Receiving the response string from the modules
wTimeOut : [Input] Communicating timeout setting, the unit=1ms
wChkSum : [Input] 0=Disable, 1=Enable
*wT: [Output] Total time of send/receive interval, unit=1 ms

Return Value:

0 is for Success
Not 0 is for Failure

Example:

```
char m_port =1;  
DWORD m_baudrate=115200;  
WORD m_timeout=100;  
WORD m_chksum=0;  
WORD m_wT;  
char m_szSend[40], m_szReceive[40];  
int RetVal;  
m_szSend[0] = '$';  
m_szSend[1] = '0';  
m_szSend[2] = '0';  
m_szSend[3] = 'M';
```

```

m_szSend[4] = 0;
/* open device file */
Open_Slot(1);
RetVal = Open_Com(m_port, m_baudrate, Data8Bit, NonParity, OneStopBit);
if (RetVal >0)
{
    printf("Open COM%d failed!\n", m_port);
    return FAILURE;
}
RetVal = Send_Receive_Cmd(m_port, m_szSend, m_szReceive, m_timeout,
                          m_chksum, &m_wT);
if (RetVal)
{
    printf("Module at COM%d Address %d error !!!\n", m_port, m_szSend[2] );
    return FAILURE;
}
Close_Com (m_port);

```

■ Send_Cmd

Description:

This function only sends a command string to DCON series modules. If the wChkSum=1, it automatically **adds the two checksum bytes to the command string**. And then the end of sending string is further added [0x0D] to mean the termination of the command (szCmd). And this command string cannot include space char within the command string. For example: "\$01M 02 03" is user's command string. However, the actual command send out is "\$01M".

Syntax:

[C]
WORD Send_Cmd (char port, char szCmd[], WORD wTimeOut, WORD wChksum)

Parameter:

port : [Input] 1=COM1, 2=COM2, 3=COM3..., 255=COM255.
szCmd : [Input] Sending command string
wTimeOut : [Input] Communicating timeout setting, the unit=1ms
wChkSum : [Input] 0=Disable, 1=Enable

Return Value:

None

Example:

```
char m_port=1;
char m_szSend[40];
DWORD m_baudrate=115200;
WORD m_timeout=100, m_chksum=0;
m_szSend[0] = '$';
m_szSend[1] = '0';
m_szSend[2] = '0';
m_szSend[3] = 'M';
Open_Slot(2); // The module is plug in slot 2 and address is 0.
Open_Com(m_port, m_baudrate, Data8Bit, NonParity, OneStopBit);
Send_Cmd(m_port, m_szSend, m_timeout, m_chksum, &m_wT);
Close_Com (m_port);
```

Remark:

■ Receive_Cmd

Description:

This function is used to obtain the responses string from the modules in RS-485 network. And this function provides a response string without the last byte [0x0D].

Syntax:

```
[ C ]  
WORD Receive_Cmd (char port, char szResult[ ], WORD wTimeOut,  
                  WORD wChecksum)
```

Parameter:

port : [Input] 1=COM1, 2=COM2, 3=COM3..., 255=COM255.
szResult : [Output] Sending command string
wTimeOut : [Input] Communicating timeout setting, the unit=1ms
wChkSum : [Input] 0=Disable, 1=Enable

Return Value:

None

Example:

```
char m_port=3;  
char m_Send[40], m_szResult[40] ;  
DWORD m_baudrate=115200;  
WORD m_timeout=100, m_checksum=0;  
m_szSend[0] = '$';  
m_szSend[1] = '0';  
m_szSend[2] = '1';  
m_szSend[3] = 'M';  
m_szSend[4] = 0;  
Open_Com (m_port, m_baudrate, Data8Bit, NonParity, OneStopBit);  
Send_Cmd (m_port, m_szSend, m_timeout, m_checksum);  
Receive_Cmd (m_port, m_szResult, m_timeout, m_checksum);  
Close_Com (m_port);  
// Read the remote module:I-7016D , m_szResult : "!017016D"
```

Remark:

■ Send_Binary

Description:

Send out the command string by fix length, which is controlled by the parameter "iLen". The difference between this function and Send_cmd is that Send_Binary terminates the sending process by the string length "iLen" instead of the character "CR"(Carry return). Therefore, this function can send out command string with or without null character under the consideration of the command length. Besides, because of this function without any error checking mechanism (Checksum, CRC, LRC... etc.), users have to add the error checking information to the raw data by themselves if communication checking system is required. Note that this function is usually applied to communicate with the other device, but not for ICP DAS DCON (I-7000/8000/87K) series modules.

Syntax:

[C]
WORD Send_Binary (char port, char szCmd[], int iLen)

Parameter:

port : [Input] 1=COM1, 2=COM2, 3=COM3..., 255=COM255.
szCmd : [Input] Sending command string
iLen : [Input] The length of command string.

Return Value:

None

Example:

```
int m_length=4;
char m_port=3, char m_szSend[40];
DWORD m_baudrate=115200;
m_szSend[0] = '0';
m_szSend[1] = '1';
m_szSend[2] = '2';
m_szSend[3] = '3';
Open_Com(m_port, m_baudrate, Data8Bit, NonParity, OneStopBit);
Send_Binary(m_port, m_szSend, m_length);
Close_Com (m_port);
```

Remark:

■ Receive_Binary

Description:

This function is applied to receive the fix length response. The length of the receiving response is controlled by the parameter "iLen". The difference between this function and Receive_cmd is that Receive_Binary terminates the receiving process by the string length "iLen" instead of the character "CR"(Carry return). Therefore, this function can be used to receive the response string data with or without null character under the consideration of receiving length. Besides, because of this function without any error checking mechanism (checksum, CRC, LRC... etc.), users have to remove from the error checking information from the raw data by themselves if communication checking system is used. Note that this function is usually applied to communicate with the other device, but not for ICP DAS DCON (I-7000/8000/87K) series modules.

Syntax:

[C]

WORD Receive_Binary (char cPort, char szResult[], WORD wTimeOut,
WORD wLen, WORD *wT)

Parameter:

port : [Input] 1=COM1, 2=COM2, 3=COM3..., 255=COM255.
szResult : [Input] Receiving the response string from the modules
wTimeOut : [Input] Communicating timeout setting, the unit=1ms
wLen : [Input] The length of command string.
*wT: [Output] Total time of send/receive interval, unit=1 ms

Return Value:

None

Example:

```
int m_length=10;  
char m_port=3;  
char m_szSend[40];  
char m_szReceive[40];  
DWORD m_baudrate=115200;  
WORD m_wt;  
WORD m_timeout=10;  
WORD m_wlength=10;
```

```
m_szSend[0] = '0';
m_szSend[1] = '1';
m_szSend[2] = '2';
m_szSend[3] = '3';
m_szSend[4] = '4';
m_szSend[5] = '5';
m_szSend[6] = '6';
m_szSend[7] = '7';
m_szSend[8] = '8';
m_szSend[9] = '9';
Open_Com(m_port, m_baudrate, Data8Bit, NonParity, OneStopBit);
Send_Binary(m_port, m_szSend, m_length);           // send 10 character
Receive_Binary(char m_port, char m_szResult[], WORD m_timeout,
               WORD m_wlength, WORD &m_wt)        // receive 10 character
Close_Com (m_port);
```

Remark:

■ sio_open

Description:

This function is used to open and initiate a specified serial port in the LinPAC-51XX. The n-port modules in the LinPAC-51XX will use this function. For example, if you want to send or receive data from a specified serial port, this function must be called first. Then the other functions can be used later.

Syntax:

```
[ C ]  
int sio_open(const char *port, speed_t baudrate, tcflag_t data, tcflag_t parity,  
            tcflag_t stop)
```

Parameter:

port : [Input] device name: /dev/ttyS0, /dev/ttyS1.../dev/ttyS34
baudrate: [Input] B1200/ B2400/ B4800/ B9600/ B19200/ B38400/ B57600/
 B115200
date : [Input] DATA_BITS_5/ DATA_BITS_6/ DATA_BITS_7/ DATA_BITS_8
parity : [Input] NO_PARITY / ODD_PARITY / EVEN_PARITY
stop : [Input] ONE_STOP_BIT / TWO_STOP_BITS

Return Value:

This function returns int port descriptor for the port opened successfully.

ERR_PORT_OPEN is for Failure

Example:

```
#define COM_M1 "/dev/ttyS0" // Defined the first port for COM2(RS-485)  
char fd[5];  
fd[0]=sio_open(COM_M1, B9600, DATA_BITS_8, NO_PARITY,ONE_STOP_BIT);  
if (fd[0] == ERR_PORT_OPEN) {  
    printf("open port_m failed!\n");  
    return (-1);  
}  
// The first port will be opened.
```

Remark:

■ `sio_close`

Description:

If you have used the function of `sio_open()` to open the specified serial port in the LinPAC-51XX, you need to use the `sio_close()` function to close the specified serial port in the LinPAC-51XX. For example, once you have finished sending or receiving data from a specified serial port, this function would then need to be called.

Syntax:

[C]
<code>int sio_close(int port)</code>

Parameter:

port : [Input] device name: `/dev/ttyS0, /dev/ttyS1.../dev/ttyS34`

Return Value:

None

Example:

```
#define COM_M2 "/dev/ttyS1" // Defined the second port for COM3(RS-232)
char fd[5];
fd[0]=sio_open(COM_M2, B9600, DATA_BITS_8, NO_PARITY, ONE_STOP_BIT);
sio_close (fd[0]);
// The second port will be closed.
```

Remark:

■ `sio_set_noncan`

Description:

If you have used the function of `sio_open()` to open the specified serial port in the LinPAC-51XX, you need to use the `sio_close()` function to close the specified serial port in the LinPAC-51XX. For example, once you have finished sending or receiving data from a specified serial port, this function would then need to be called.

set a opened serial port to non-canonical mode

Syntax:

[C]
<code>int sio_set_noncan (int port)</code>

Parameter:

port : [Input] device name: /dev/ttyS0, /dev/ttyS1.../dev/ttyS34

Return Value:

None

Example:

```
#define COM_M2 "/dev/ttyS1" // Defined the second port for COM3(RS-232)
char fd[5];
fd[0]=sio_open(COM_M2, B9600, DATA_BITS_8, NO_PARITY,ONE_STOP_BIT);
sio_close (fd[0]);
// The second port will be closed.
```

Remark:

■ Read_SN

Description:

This function is used to retrieve the hardware serial identification number on the LinPAC-51XX main controller. This function supports the control of hardware versions by reading the serial ID chip

Syntax:

```
[ C ]  
void Read_SN(unsigned char serial_num[])
```

Parameter:

serial_num : [Output] Receive the serial ID number.

Return Value:

None

Example:

```
int slot ;  
unsigned char serial_num[8];  
Open_Slot(0);  
Read_SN(serial_num);  
printf("SN=%x%x%x%x%x%x%x%x\n",serial_num[0],serial_num[1], serial_num[2]  
      ,serial_num[3],serial_num[4],serial_num[5],serial_num[6],serial_num[7]);
```

Remark:

■ SetLED

Description:

This function is used to turn the LinPAC-51XX LED's on/off.

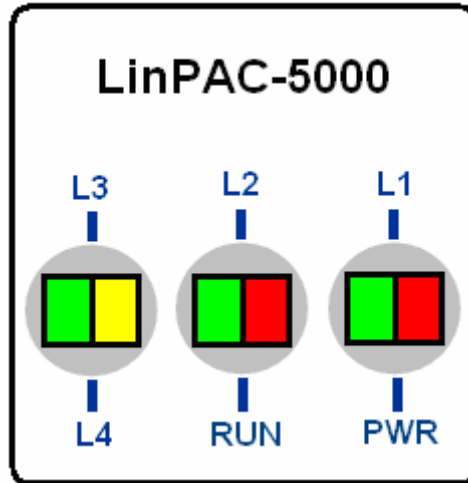

Address	L4	L3	L2	RUN/L5	PWR	L1
Color	Green	Yellow	Green	Red	Green	Red
Programmable	Yes	Yes	Yes	Yes	No	Yes
Function	None	None	None	Start	Power	None

Syntax:

[C]

```
void SetLED(unsigned int addr, unsigned int value)
```

Parameter:

addr : [Input] Range of programmable LED display is 1~5

value : [Input] **1** : Turn on the LED
0 : Turn off the LED

Return Value:

None

Example:

```
unsigned int addr,value;  
addr=4;  
value=1;  
SetLED(addr, value);  
// Turn on the LED4.
```

Remark:

■ GetBackPlaneID

Description:

This function is used to retrieve the back plane ID number in the LinPAC-51XX.

Syntax:

```
int GetBackPlaneID() [ C ]
```

Parameter:

None

Return Value:

Backplane ID number.

Example:

```
int id;  
id=GetBackPlaneID();  
printf("GetBackPlaneID =%d \n", id);  
// Get the LinPAC-51XX backplane id . Returned Value: GetBackPlaneID = 2
```

Remark:

■ GetRotaryID

Description:

This function is used to retrieve the rotary ID number in the LinPAC-51XX.

Syntax:

```
int GetRotaryID(int type, &id) [ C ]
```

Parameter:

slot : [input] number of slot.
id: [Output] Rotary ID number

Return Value:

0 is for Success
Not 0 is for Failure

SW	0	1	2	3	4	5	6	7	8	9
ID	47	46	45	44	43	42	41	40	39	38

Example:

```
int id, slot, type, wRetVal;  
switch(type){  
    case 1:  
        slot = 0;  
        break;  
    case 2: //Only for LinPAC-51XX  
        slot = 8;  
        break;  
    default:  
        slot = 0;  
        break;  
}  
wRetVal = Open_Slot(slot);  
if (wRetVal > 0) {  
    printf("open Slot%d failed!\n",slot);  
    return (-1);  
}  
id= GetRotaryID(type, &id);  
printf("GetRotaryID =%d \n",id); // Get the LinPAC-51XX rotary id. If user turn the rotary  
switch to the 1 position, would get the returned value: GetRotaryID = 78
```

Remark:

■ GetSDKversion

Description:

This function is used to retrieve the version of LinPAC-51XX SDK.

Syntax:

```
float GetSDKversion(void) [ C ]
```

Parameter:

None

Return Value:

Version number.

Example:

```
printf(" GetSDKversion = %4.2f \n ", GetSDKversion());  
// Get the LinPAC-51XX SDK version number.  
// Returned Value: GetSDKversion = 1.0
```

Remark:

■ GetNameOfModule

Description:

This function is used to retrieve the name of an XWboard series I/O module, which is plugged into a slot in the LinPAC-51XX. This function supports the collection of system hardware configurations.

Syntax:

```
[ C ]  
  
int GetNameOfModule_xw()
```

Parameter:

slot: [Input] Specify the slot number where the I/O module is plugged into.

Return Value:

I/O module ID. For Example, return XW107 if the XW107 plugin LP-5000.

Example:

```
int slot;  
int moduleID;  
Open_Slot(1);  
moduleID=GetNameOfModule_xw();  
Close_Slot(1);  
// The XW107 card plugged in slot 1 of LinPAC-51XX  
// Returned Value: moduleName=" XW107 "
```

Remark:

One LinPAC-51XX can only plug only one XWboard.



6.2 Watch Dog Timer Functions

■ EnableWDT

■ DisableWDT

Description:

This function can be used to enable the watch dog timer (WDT) and users need to reset WDT in the assigned time set by users. Or LinPAC will reset automatically.

Syntax:

```
[C]
void EnableWDT(unsigned int msecond)
void DisableWDT(void)
```

Parameter:

msecond: LinPAC will reset in the assigned time if users don't reset WDT.
The unit is mini-second.

Return Value:

None

Example:

```
EnableWDT(10000); //Enable WDT interval 10000ms=10s
while (getchar()=='10')
{
    printf("Refresh WDT\n");
    EnableWDT(10000); //Refresh WDT 10s
}
printf("Disable WDT\n");
DisableWDT();
```

Remark:

■ WatchDogSWEven

Description:

This function is used to read the LinPAC Reset Condition and users can reinstall the initial value according to the Reset Condition.

Syntax:

```
                                [C]  
unsigned int WatchDogSWEven (void)
```

Parameter:

None

Return Value:

Just see the last number of the return value – **RCSR** (Reset Controller Status Register).
For example : RCSR is “20009a4”, so just see the last number “4”. 4 is **0100** in bits and it means :

Bit 0 : **Hardware Reset** (Like : Power Off, Reset Button)

Bit 1 : **Software Reset** (Like : Type “Reboot” in command prompt)

Bit 2 : **WDT Reset** (Like : Use “EnableWDT(1000)”)

Bit 3 : **Sleep Mode Reset** (Not supported in the LinPAC)

Example:

```
printf("RCRS = %x\n", WatchDogSWEven() );
```

Remark:

■ ClearWDTSEven

Description:

This function is used to clear RCSR value.

Syntax:

```
[C]  
void ClearWDTSEven (unsigned int rcsr)
```

Parameter:

rcsr : Clear bits of RCSR. Refer to the following parameter setting :

1 : clear bit 0

2 : clear bit 1

4 : clear bit 2

8 : clear bit 3

F : clear bit 0 ~ bit 3

Return Value:

None

Example:

```
ClearWDTSEven(0xF) ; // Used to clear bit 0 ~ bit 3 of RCRS to be zero.
```

Remark:

6.3 EEPROM Read/Write Functions

■ Enable_EEP

Description:

This function is used to make EEPROM able to read or write. It must be used before using Read_EEP or Write_EEP. This EEPROM is divided into 256 blocks (0 to 255), and each block is 64 bytes in length from offset 0 to 63.

Syntax:

[C]
<code>void Enable_EEP(void)</code>

Parameter:

None

Return Value:

None

Example:

```
Enable_EEP();  
// After using this function, you can use Write_EEP or Read_EEP to write or read  
// data of EEPROM.
```

Remark:

■ Disable_EEP

Description:

This function is used to make EEPROM unable to read or write. You need to use this function after using Read_EEP or Write_EEP. Then it will protect you from modifying your EEPROM data carelessly.

Syntax:

```
void Disable_EEP(void) [ C ]
```

Parameter:

None

Return Value:

None

Example:

```
Disable_EEP();  
// After using this function, you will not use Write_EEP or Read_EEP to write or  
// read data of EEPROM.
```

Remark:

■ Read_EEP

Description:

This function will read one byte data from the EEPROM. There is a 16K-byte EEPROM in the main control unit in the LinPAC-51XX system. This EEPROM is divided into 256 blocks (0 to 255), and each block is 64 bytes in length from offset 0 to 63. This EEPROM with its accessing APIs provides another mechanism for storing critical data inside non-volatile memory.

Syntax:

```
[ C ]  
unsigned char Read_EEP(int block, int offset)
```

Parameter:

block : [Input] the block number of EEPROM.

offset: [Input] the offset within the block.

Return Value:

Data read from the EEPROM.

Example:

```
int block, offset;  
unsigned char data;  
data= ReadEEP(block, offset);  
// Returned value: data= read an 8-bit value from the EEPROM (block & offset)
```

Remark:

■ Write_EEP

Description:

To write one byte of data to the EEPROM. There is a 16K-byte EEPROM in the main control unit of the LinPAC-51XX system. This EEPROM is divided into 256 blocks (0 to 255), and each block is 64 bytes in length from the offset of 0 to 63. This EEPROM with its accessing APIs, provides another mechanism for storing critical data inside non-volatile memory.

Syntax:

```
[ C ]  
void Write_EEP(int block, int offset, unsigned char data)
```

Parameter:

block : [Input] the block number of EEPROM.
offset: [Input] the offset within the block.
Data: [Input] data to write to EEPROM.

Return Value:

None

Example:

```
int block, offset;  
unsigned char data=10;  
WriteEEP(block, offset, data);  
// Writes a 10 value output to the EEPROM (block & offset) location
```

Remark:

6.4 Digital Input/Output Functions

6.4.1 I-7000 series modules

■ DigitalOut

Description:

This function is used to output the value of the digital output module for I-7000 series modules.

Syntax:

```
[ C ]  
WORD DigitalOut(WORD wBuf[], float fBuf[], char szSend[], char szReceive[])
```

Parameter:

wBuf: WORD Input/Output argument talbe
wBuf[0] : [Input] COM port number, from 1 to 255
wBuf[1] : [Input] Module address, form 0x00 to 0xFF
wBuf[2] : [Input] Module ID, 0x7011/12/14/42/43/44/50/60/63/65/66/67/80
wBuf[3] : [Input] 0= Checksum disable; 1= Checksum enable
wBuf[4] : [Input] Timeout setting , normal=100 msecond
wBuf[5] : [Input] 16-bit digital output data
wBuf[6] : [Input] 0 → no save to szSend &szReceive
 1 → Save to szSend &szReceive
fBuf : Not used.
szSend : [Input] Command string to be sent to I-7000 series modules.
szReceive : [Output] Result string receiving from I-7000 series modules .

Return Value:

0 is for Success
Not 0 is for Failure

Example:

```
char szSend[80];  
char szReceive[80];  
float fBuf[12];  
WORD wBuf[12];  
WORD m_port=3;  
WORD m_address=1;  
WORD m_timeout=100;
```



```

WORD m_checksum=0;
Open_Com(COM3, 9600, Data8Bit, NonParity, OneStopBit);
wBuf[0] = m_port;
wBuf[1] = m_address;
wBuf[2] = 0x7050;
wBuf[3] = m_checksum;
wBuf[4] = m_timeout;
wBuf[5] = 0x0f;           // 8 DO Channels On
wBuf[6] = 0;
DigitalOut(wBuf, fBuf, szSend, szReceive);
Close_Com(COM3);

```

Remark:

■ **DigitalBitOut**

Description:

This function is used to set digital output value of the channel No. of I-7000 series modules. The output value is “0” or “1”.

Syntax:

[C]

WORD DigitalBitOut(WORD wBuf[], float fBuf[], char szSend[], char szReceive[])

Parameter:

- wBuf: WORD Input/Output argument talbe
- wBuf[0] : [Input] COM port number, from 1 to 255
- wBuf[1] : [Input] Module address, form 0x00 to 0xFF
- wBuf[2] : [Input] Module ID, 0x7042/43/44/50/60/63/65/66/67
- wBuf[3] : [Input] 0= Checksum disable; 1= Checksum enable
- wBuf[4] : [Input] Timeout setting , normal=100 msecond
- wBuf[5] : Not used
- wBuf[6] : [Input] 0 → no save to szSend &szReceive
1 → Save to szSend &szReceive
- wBuf[7] : [Input] The digital output channel No.
- wBuf[8] : [Input] Logic value(0 or 1)

fBuf : Not used.
szSend : [Input] Command string to be sent to I-7000 series modules.
szReceive : [Output] Result string receiving from I-7000 series modules .

Return Value:

0 is for Success

Not 0 is for Failure

Example:

```
char szSend[80];
char szReceive[80];
float fBuf[12];
WORD wBuf[12];
WORD m_port=3;
WORD m_address=1;
WORD m_timeout=100;
WORD m_checksum=0;
Open_Com(COM3, 9600, Data8Bit, NonParity, OneStopBit);
wBuf[0] = m_port;
wBuf[1] = m_address;
wBuf[2] = 0x7065;
wBuf[3] = m_checksum;
wBuf[4] = m_timeout;
wBuf[6] = 0;
wBuf[7] = 0x08;           //RL4 relay On
wBuf[8] = 1;
DigitalBitOut (wBuf, fBuf, szSend, szReceive);
Close_Com(COM3);
```

Remark:

■ DigitalOutReadBack

Description:

This function is used to read back the digital output value of I-7000 series modules.

Syntax:

```
[ C ]  
WORD DigitalOutReadBack(WORD wBuf[ ], float fBuf[ ],char szSend[ ],  
                        char szReceive[ ])
```

Parameter:

wBuf: WORD Input/Output argument talbe
wBuf[0] : [Input] COM port number, from 1 to 255
wBuf[1] : [Input] Module address, form 0x00 to 0xFF
wBuf[2] : [Input] Module ID, 0x7042/43/44/50/60/63/65/66/67/80
wBuf[3] : [Input] 0=Checksum disable; 1=Checksum enable
wBuf[4] : [Input] Timeout setting , normal=100 msecond
wBuf[5] : [Output] 16-bit digital output data read back
wBuf[6] : [Input] 0 → no save to szSend &szReceive
 1 → Save to szSend &szReceive
fBuf : Not used.
szSend : [Input] Command string to be sent to I-7000 series modules.
szReceive : [Output] Result string receiving from I-7000 series modules .

Return Value:

0 is for Success
Not 0 is for Failure

Example:

```
char szSend[80];  
char szReceive[80];  
float fBuf[12];  
WORD DO;  
WORD wBuf[12];  
WORD m_port=3;  
WORD m_address=1;  
WORD m_timeout=100;  
WORD m_checksum=0;  
Open_Com(COM3, 9600, Data8Bit, NonParity, OneStopBit);  
wBuf[0] = m_port;  
wBuf[1] = m_address;
```

```

wBuf[2] = 0x7050;
wBuf[3] = m_checksum;
wBuf[4] = m_timeout;
wBuf[6] = 0;
DigitalOutReadBack (wBuf, fBuf, szSend, szReceive);
DO=wBuf[5];
Close_Com(COM3);

```

Remark:

■ **DigitalOut_7016**

Description:

This function is used to set the digital output value of the specified channel No. of I-7016 module. If the parameter of wBuf[7] is “0”, it means to output the digital value through Bit0 and Bit1 digital output channels. If wBuf[7] is “1”, it means to output the digital value through Bit2 and Bit3 digital output channels.

Syntax:

[C]

WORD DigitalOut_7016(**WORD** wBuf[], **float** fBuf[], **char** szSend[], **char** szReceive[])

Parameter:

- wBuf: WORD Input/Output argument talbe
- wBuf[0] : [Input] COM port number, from 1 to 255
- wBuf[1] : [Input] Module address, form 0x00 to 0xFF
- wBuf[2] : [Input] Module ID, 0x7016
- wBuf[3] : [Input] 0= Checksum disable; 1= Checksum enable
- wBuf[4] : [Input] Timeout setting , normal=100 msecond
- wBuf[5] : [Input] 2-bit digital output data in decimal format
- wBuf[6] : [Input] 0 → no save to szSend &szReceive
1 → Save to szSend &szReceive
- wBuf[7] : [Input] 0 : Bit0, Bit1 output
1 : Bit2, Bit3 output
- fBuf : Not used.
- szSend : [Input] Command string to be sent to I-7000 series modules.
- szReceive : [Output] Result string receiving from I-7000 series modules .

Return Value:

0 is for Success

Not 0 is for Failure

Example:

```
char szSend[80];
char szReceive[80];
float fBuf[12];
WORD wBuf[12];
WORD m_port=3;
WORD m_address=1;
WORD m_timeout=100;
WORD m_checksum=0;
Open_Com(COM3, 9600, Data8Bit, NonParity, OneStopBit);
wBuf[0] = m_port;
wBuf[1] = m_address;
wBuf[2] = 0x7016;
wBuf[3] = m_checksum;
wBuf[4] = m_timeout;
wBuf[5] = 1;
wBuf[6] = 0;
wBuf[7] = 1;    // Set the Bit2, Bit3 digital output
DigitalOut_7016(wBuf, fBuf, szSend, szReceive);
Close_Com(COM3);
```

Remark:

■ DigitalIn

Description:

This function is used to obtain the digital input value from I-7000 series modules.

Syntax:

```
[ C ]  
WORD DigitalIn(WORD wBuf[], float fBuf[], char szSend[], char szReceive[])
```

Parameter:

wBuf: WORD Input/Output argument talbe
wBuf[0] : [Input] COM port number, from 1 to 255
wBuf[1] : [Input] Module address, form 0x00 to 0xFF
wBuf[2] : [Input] Module ID, 0x7041/44/50/52/53/55/58/60/63/65
wBuf[3] : [Input] 0= Checksum disable; 1= Checksum enable
wBuf[4] : [Input] Timeout setting , normal=100 msecond
wBuf[5] : [Output] 16-bit digital output data
wBuf[6] : [Input] 0 → no save to szSend &szReceive
 1 → Save to szSend &szReceive
fBuf : Not used.
szSend : [Input] Command string to be sent to I-7000 series modules.
szReceive : [Output] Result string receiving from I-7000 series modules .

Return Value:

0 is for Success
Not 0 is for Failure

Example:

```
char szSend[80];  
char szReceive[80];  
float fBuf[12];  
WORD DI;  
WORD wBuf[12];  
WORD m_port=3;  
WORD m_address=1;  
WORD m_timeout=100;  
WORD m_checksum=0;  
Open_Com(COM3, 9600, Data8Bit, NonParity, OneStopBit);  
wBuf[0] = m_port;  
wBuf[1] = m_address;  
wBuf[2] = 0x7050;
```

```

wBuf[3] = m_checksum;
wBuf[4] = m_timeout;
wBuf[6] = 0;
DigitalIn(wBuf, fBuf, szSend, szReceive);
DI=wBuf[5];
Close_Com(COM3);

```

Remark:

■ **DigitalInLatch**

Description:

This function is used to obtain the latch value of the high or low latch mode of digital input module.

Syntax:

```

[ C ]
WORD DigitalInLatch(WORD wBuf[], float fBuf[], char szSend[], char szReceive[])

```

Parameter:

- wBuf: WORD Input/Output argument talbe
- wBuf[0] : [Input] COM port number, from 1 to 255
- wBuf[1] : [Input] Module address, form 0x00 to 0xFF
- wBuf[2] : [Input] Module ID, 0x7041/44/50/52/53/55/58/60/63/65/66
- wBuf[3] : [Input] 0= Checksum disable; 1= Checksum enable
- wBuf[4] : [Input] Timeout setting , normal=100 msecond
- wBuf[5] : [Input] 0: low Latch mode ; 1:high Latch mode
- wBuf[6] : [Input] 0 → no save to szSend &szReceive
1 → Save to szSend &szReceive
- wBuf[7] : [Output] Latch value
- fBuf : Not used.
- szSend : [Input] Command string to be sent to I-7000 series modules.
- szReceive : [Output] Result string receiving from I-7000 series modules .

Return Value:

- 0 is for Success
- Not 0 is for Failure

Example:

```
char szSend[80];
char szReceive[80];
float fBuf[12];
WORD wBuf[12];
WORD m_port=3;
WORD m_address=1;
WORD m_timeout=100;
WORD m_checksum=0;
Open_Com(COM3, 9600, Data8Bit, NonParity, OneStopBit);
wBuf[0] = m_port ;
wBuf[1] = m_address ;
wBuf[2] = 0x7050;
wBuf[3] = m_checksum ;
wBuf[4] = m_timeout ;
wBuf[5] = 1;      // Set the high Latch mode
wBuf[6] = 0;
wBuf[7] = 0x03;  // Set the Latch value
DigitalInLatch(wBuf, fBuf, szSend, szReceive);
Close_Com(COM3);
```

Remark:

■ ClearDigitalInLatch

Description:

This function is used to clear the latch status of digital input module when latch function has been enable.

Syntax:

```
[ C ]  
WORD ClearDigitalInLatch(WORD wBuf[], float fBuf[],char szSend[],  
char szReceive[])
```

Parameter:

wBuf: WORD Input/Output argument talbe
wBuf[0] : [Input] COM port number, from 1 to 255
wBuf[1] : [Input] Module address, form 0x00 to 0xFF
wBuf[2] : [Input] Module ID, 0x7011/12/14/42/43/44/50/55/58/60/63/65/66/67
wBuf[3] : [Input] 0= Checksum disable; 1= Checksum enable
wBuf[4] : [Input] Timeout setting , normal=100 msecond
wBuf[5] : Not used.
wBuf[6] : [Input] 0 → no save to szSend &szReceive
1 → Save to szSend &szReceive
fBuf : Not used.
szSend : [Input] Command string to be sent to I-7000 series modules.
szReceive : [Output] Result string receiving from I-7000 series modules .

Return Value:

0 is for Success
Not 0 is for Failure

Example:

```
char szSend[80];  
char szReceive[80];  
float fBuf[12];  
WORD wBuf[12];  
WORD m_port=3;  
WORD m_address=1;  
WORD m_timeout=100;  
WORD m_checksum=0;  
Open_Com(COM3, 9600, Data8Bit, NonParity, OneStopBit);  
wBuf[0] = m_port;  
wBuf[1] = m_address;
```

```

wBuf[2] = 0x7050;
wBuf[3] = m_checksum;
wBuf[4] = m_timeout;
wBuf[6] = 0;
ClearDigitalInLatch(wBuf, fBuf, szSend, szReceive);
Close_Com(COM3);

```

Remark:

■ **DigitalInCounterRead**

Description:

This function is used to obtain the counter event value of the channel number of digital input module.

Syntax:

<p>[C]</p> <pre> WORD DigitalInCounterRead(WORD wBuf[], float fBuf[], char szSend[], char szReceive[]) </pre>
--

Parameter:

- wBuf: WORD Input/Output argument talbe
- wBuf[0] : [Input] COM port number, from 1 to 255
- wBuf[1] : [Input] Module address, form 0x00 to 0xFF
- wBuf[2] : [Input] Module ID, 0x7041/44/50/51/52/53/55/58/60/63/65
- wBuf[3] : [Input] 0= Checksum disable; 1= Checksum enable
- wBuf[4] : [Input] Timeout setting , normal=100 msecond
- wBuf[5] : [Input] The digital input Channel No.
- wBuf[6] : [Input] 0 → no save to szSend &szReceive
1 → Save to szSend &szReceive
- wBuf[7] : [Output] Counter value of the digital input channel No.
- fBuf : Not used.
- szSend : [Input] Command string to be sent to I-7000 series modules.
- szReceive : [Output] Result string receiving from I-7000 series modules .

Return Value:

0 is for Success

Not 0 is for Failure

Example:

```
char szSend[80];
char szReceive[80];
float fBuf[12];
WORD DI_counter;
WORD wBuf[12];
WORD m_port=3;
WORD m_address=1;
WORD m_timeout=100;
WORD m_checksum=0;
Open_Com(COM3, 9600, Data8Bit, NonParity, OneStopBit);
wBuf[0] = m_port;
wBuf[1] = m_address;
wBuf[2] = 0x7050;
wBuf[3] = m_checksum;
wBuf[4] = 100;
wBuf[5] = 0;           // Set the digital input channel No.
wBuf[6] = 0;
DigitalInCounterRead(wBuf, fBuf, szSend, szReceive);
DI_counter=wBuf[7];
Close_Com(COM3);
```

Remark:

■ ClearDigitalInCounter

Description:

This function is used to clear the counter value of the channel number of digital input module.

Syntax:

```
[ C ]  
WORD ClearDigitalInCounter(WORD wBuf[], float fBuf[],char szSend[],  
                           char szReceive[])
```

Parameter:

wBuf: WORD Input/Output argument talbe
wBuf[0] : [Input] COM port number, from 1 to 255
wBuf[1] : [Input] Module address, form 0x00 to 0xFF
wBuf[2] : [Input] Module ID, 0x7041/44/50/51/52/53/55/58/60/63/65
wBuf[3] : [Input] 0= Checksum disable; 1= Checksum enable
wBuf[4] : [Input] Timeout setting , normal=100 msecond
wBuf[5] : [Input] The digital input channel No.
wBuf[6] : [Input] 0 → no save to szSend &szReceive
 1 → Save to szSend &szReceive
fBuf : Not used.
szSend : [Input] Command string to be sent to I-7000 series modules.
szReceive : [Output] Result string receiving from I-7000 series modules .

Return Value:

0 is for Success
Not 0 is for Failure

Example:

```
char szSend[80];  
char szReceive[80];  
float fBuf[12];  
WORD wBuf[12];  
WORD m_port=3;  
WORD m_address=1;  
WORD m_timeout=100;  
WORD m_checksum=0;  
Open_Com(COM3, 9600, Data8Bit, NonParity, OneStopBit);  
wBuf[0] = m_port;  
wBuf[1] = m_address;
```

```

wBuf[2] = 0x7050;
wBuf[3] = m_checksum;
wBuf[4] = m_timeout;
wBuf[5] = 0;           // Set the digital input channel No.
wBuf[6] = 0;
ClearDigitalInCounter(wBuf, fBuf, szSend, szReceive);
Close_Com(COM3);

```

Remark:

■ **ReadEventCounter**

Description:

This function is used to obtain the value of event counter of I-7000 series modules. This function only supports I-7011, I-7012, I-7014 and I-7016 modules.

Syntax:

```

[ C ]
WORD ReadEventCounter(WORD wBuf[], float fBuf[],char szSend[],
char szReceive[])

```

Parameter:

- wBuf: WORD Input/Output argument talbe
- wBuf[0] : [Input] COM port number, from 1 to 255
- wBuf[1] : [Input] Module address, form 0x00 to 0xFF
- wBuf[2] : [Input] Module ID, 0x7011/12/14/16
- wBuf[3] : [Input] 0= Checksum disable; 1= Checksum enable
- wBuf[4] : [Input] Timeout setting , normal=100 msecond
- wBuf[5] : Not used
- wBuf[6] : [Input] 0 → no save to szSend &szReceive
1 → Save to szSend &szReceive
- wBuf[7] : [Output] The value of event counter
- fBuf : Not used.
- szSend : [Input] Command string to be sent to I-7000 series modules.
- szReceive : [Output] Result string receiving from I-7000 series modules .

Return Value:

0 is for Success

Not 0 is for Failure

Example:

```
char szSend[80];
char szReceive[80];
float fBuf[12];
WORD Counter;
WORD wBuf[12];
WORD m_port=3;
WORD m_address=1;
WORD m_timeout=100;
WORD m_checksum=0;
Open_Com(COM3, 9600, Data8Bit, NonParity, OneStopBit);
wBuf[0] = m_port;
wBuf[1] = m_address;
wBuf[2] = 0x7012;
wBuf[3] = m_checksum;
wBuf[4] = m_timeout;
wBuf[6] = 0;
ReadEventCounter (wBuf, fBuf, szSend, szReceive);
Counter=wBuf[7];
Close_Com(COM3);
```

Remark:

■ ClearEventCounter

Description:

This function is used to clear the value of event counter of I-7000 series modules. This function only supports I-7011, I-7012, I-7014 and I-7016 modules.

Syntax:

```
[ C ]  
WORD ClearEventCounter(WORD wBuf[], float fBuf[], char szSend[],  
                        char szReceive[])
```

Parameter:

wBuf: WORD Input/Output argument talbe
wBuf[0] : [Input] COM port number, from 1 to 255
wBuf[1] : [Input] Module address, form 0x00 to 0xFF
wBuf[2] : [Input] Module ID, 0x7011/12/14/16
wBuf[3] : [Input] 0= Checksum disable; 1= Checksum enable
wBuf[4] : [Input] Timeout setting , normal=100 msecond
wBuf[5] : Not used
wBuf[6] : [Input] 0 → no save to szSend &szReceive
 1 → Save to szSend &szReceive
fBuf : Not used.
szSend : [Input] Command string to be sent to I-7000 series modules.
szReceive : [Output] Result string receiving from I-7000 series modules .

Return Value:

0 is for Success
Not 0 is for Failure

Example:

```
char szSend[80];  
char szReceive[80];  
float fBuf[12];  
WORD wBuf[12];  
WORD m_port=3;  
WORD m_address=1;  
WORD m_timeout=100;  
WORD m_checksum=0;  
Open_Com(COM3, 9600, Data8Bit, NonParity, OneStopBit);  
wBuf[0] = m_port;  
wBuf[1] = m_address;
```

```
wBuf[2] = 0x7012;  
wBuf[3] = m_checksum;  
wBuf[4] = m_timeout;  
wBuf[6] = 0;  
ClearEventCounter (wBuf, fBuf, szSend, szReceive);  
Close_Com(COM3);
```

Remark:

6.5 Analog Input Functions

6.5.1 I-7000 series modules

■ AnalogIn

Description:

This function is used to obtain input value form I-7000 series modules.

Syntax:

```
[ C ]  
WORD AnalogIn (WORD wBuf[], float fBuf[],char szSend[],char szReceive[])
```

Parameter:

wBuf: WORD Input/Output argument talbe
wBuf[0] : [Input] COM port number, from 1 to 255
wBuf[1] : [Input] Module address, form 0x00 to 0xFF
wBuf[2] : [Input] Module ID, 0x7005/11/12/13/14/15/16/17/18/19/33
wBuf[3] : [Input] 0= Checksum disable; 1= Checksum enable
wBuf[4] : [Input] Timeout setting , normal=100 msecond
wBuf[5] : [Input] Channel number for multi-channel
wBuf[6] : [Input] 0 → no save to szSend & szReceive
 1 → Save to szSend & szReceive
fBuf : Float Input/Ouput argument table.
fBuf[0] : [Output] Analog input value return
szSend : [Input] Command string to be sent to I-7000 series modules.
szReceive : [Output] Result string receiving from I-7000 series modules .

Note : “wBuf[6]” is the debug setting. If this parameter is set as “1”, user can get whole command string and result string from szSend[] and szReceive[] respectively.

Return Value:

0 is for Success
Not 0 is for Failure

Example:

```
float A;  
float fBuf[12];  
char szSend[80];  
char szReceive[80];  
WORD wBuf[12];  
WORD m_port=3;
```

```
WORD m_address=1;
WORD m_timeout=100;
WORD m_checksum=0;
Open_Com(COM3, 9600, Data8Bit, NonParity, OneStopBit);
wBuf[0] = m_port;
wBuf[1] = m_address;
wBuf[2] = 0x7016;
wBuf[3] = m_checksum;
wBuf[4] = m_timeout;
wBuf[5] = 0;
wBuf[6] = 1;
AnalogIn (wBuf, fBuf, szSend, szReceive); // szSend="#02" , szReceive=">+001.9"
AI = fBuf[0]; // AI = 1.9
Close_Com(COM3);
```

Remark:

■ AnalogInHex

Description:

This function is used to obtain the analog input value in “Hexadecimal” form I-7000 series modules.

Syntax:

[C]

`WORD AnalogInHex (WORD wBuf[], float fBuf[],char szSend[],char szReceive[])`

Parameter:

- wBuf: WORD Input/Output argument talbe
 - wBuf[0] : [Input] COM port number, from 1 to 255
 - wBuf[1] : [Input] Module address, form 0x00 to 0xFF
 - wBuf[2] : [Input] Module ID, 0x7005/11/12/13/14/15/16/17/18/19/33
 - wBuf[3] : [Input] 0= Checksum disable; 1= Checksum enable
 - wBuf[4] : [Input] Timeout setting , normal=100 msecond
 - wBuf[5] : [Input] Channel number for multi-channel
 - wBuf[6] : [Input] 0 → no save to szSend & szReceive
1 → Save to szSend & szReceive
 - wBuf[7] : [Ouput] The analog input value in “Hexadecimal “ format
 - fBuf : Not used.
 - szSend : [Input] Command string to be sent to I-7000 series modules.
 - szReceive : [Output] Result string receiving from I-7000 series modules .
- Note** : Users have to use DCON utility to set up the analog input configuration of the module in hex format.

Return Value:

- 0 is for Success
- Not 0 is for Failure

Example:

```
float A;  
float fBuf[12];  
char szSend[80];  
char szReceive[80];  
WORD wBuf[12];  
WORD m_port=3;  
WORD m_address=1;  
WORD m_timeout=100;
```

```

WORD m_checksum=0;
Open_Com(COM3, 9600, Data8Bit, NonParity, OneStopBit);
wBuf[0] = m_port;
wBuf[1] = m_address;
wBuf[2] = 0x7012;
wBuf[3] = m_checksum;
wBuf[4] = m_timeout;
wBuf[5] = 0;
wBuf[6] = 1;
AnalogInHex (wBuf, fBuf, szSend, szReceive);
AI = wBuf[7];                // Hex format
Close_Com(COM3);

```

Remark:

■ AnalogInFsr

Description:

This function is used to obtain the analog input value in “FSR” format form I-7000 series modules. The “FSR” means “Percent” format.

Syntax:

[C]
WORD AnalogInFsr (WORD wBuf[], float fBuf[],char szSend[],char szReceive[])

Parameter:

wBuf: WORD Input/Output argument talbe

wBuf[0] : [Input] COM port number, from 1 to 255

wBuf[1] : [Input] Module address, form 0x00 to 0xFF

wBuf[2] : [Input] Module ID, 0x7005/11/12/13/14/15/16/17/18/19/33

wBuf[3] : [Input] 0= Checksum disable; 1= Checksum enable

wBuf[4] : [Input] Timeout setting , normal=100 msecond

wBuf[5] : [Input] Channel number for multi-channel

wBuf[6] : [Input] 0 → no save to szSend & szReceive
1 → Save to szSend &szReceive

fBuf : Float Input/Output argument table.

fBuf[0] : [Output] Analog input value return

szSend : [Input] Command string to be sent to I-7000 series modules.

szReceive : [Output] Result string receiving from I-7000 series modules .

Note : Users have to use DCON utility to set up the analog input configuration of the module in hex format.

Return Value:

0 is for Success

Not 0 is for Failure

Example:

```
float AI;
float fBuf[12];
char szSend[80];
char szReceive[80];
WORD wBuf[12];
WORD m_port=3;
WORD m_address=1;
WORD m_timeout=100;
WORD m_checksum=0;
Open_Com(COM3, 9600, Data8Bit, NonParity, OneStopBit);
wBuf[0] = m_port;
wBuf[1] = m_address;
wBuf[2] = 0x7012;
wBuf[3] = m_checksum;
wBuf[4] = m_timeout;
wBuf[5] = 0;
wBuf[6] = 1;
AnalogInFsr (wBuf, fBuf, szSend, szReceive);
AI = wBuf[7];
Close_Com(COM3);
```

Remark:

■ AnalogInAll

Description:

This function is used to obtain the analog input value of all channels form I-7000 series modules.

Syntax:

```
[ C ]  
WORD AnalogInAll (WORD wBuf[], float fBuf[],char szSend[],char szReceive[])
```

Parameter:

wBuf: WORD Input/Output argument talbe
wBuf[0] : [Input] COM port number, from 1 to 255
wBuf[1] : [Input] Module address, form 0x00 to 0xFF
wBuf[2] : [Input] Module ID, 0x7005/15/16/17/18/19/33
wBuf[3] : [Input] 0= Checksum disable; 1= Checksum enable
wBuf[4] : [Input] Timeout setting , normal=100 msecond
wBuf[6] : [Input] 0 → no save to szSend & szReceive
 1 → Save to szSend & szReceive
fBuf : Float Input/Output argument table.
fBuf[0] : [Output] Analog input value return of channel_0
fBuf[1] : [Output] Analog input value return of channel_1
fBuf[2] : [Output] Analog input value return of channel_2
fBuf[3] : [Output] Analog input value return of channel_3
fBuf[4] : [Output] Analog input value return of channel_4
fBuf[5] : [Output] Analog input value return of channel_5
fBuf[6] : [Output] Analog input value return of channel_6
fBuf[7] : [Output] Analog input value return of channel_7
szSend : [Input] Command string to be sent to I-7000 series modules.
szReceive : [Output] Result string receiving from I-7000 series modules .

Note : Users have to use DCON utility to set up the analog input configuration of the module in hex format.

Return Value:

0 is for Success
Not 0 is for Failure

Example:

```
float AI[12];  
float fBuf[12];  
char szSend[80];
```

```
char szReceive[80];
WORD wBuf[12];
WORD m_port=3;
WORD m_address=1;
WORD m_timeout=100;
WORD m_checksum=0;
Open_Com(COM3, 9600, Data8Bit, NonParity, OneStopBit);
wBuf[0] = m_port;
wBuf[1] = m_address;
wBuf[2] = 0x7017;
wBuf[3] = m_checksum;
wBuf[4] = m_timeout;
wBuf[6] = 1;
AnalogInAll (wBuf, fBuf, szSend, szReceive);
AI[0] = fBuf[0];
AI[0] = fBuf[1];
AI[0] = fBuf[2];
AI[0] = fBuf[3];
AI[0] = fBuf[4];
AI[0] = fBuf[5];
AI[0] = fBuf[6];
AI[0] = fBuf[7];
Close_Com(COM3);
```

Remark:

■ ThermocoupleOpen_7011

Description:

This function is used to detect the thermocouple state of I-7011 modules for the supporting type “J, K, T, E, R, S, B, N, C” is open or close. If the response value is “0”, thermocouple I-7011 is working in close state. If the response value is “1”, thermocouple I-7011 is working in open state. For more information please refer to user manual.

Syntax:

```
[ C ]  
WORD ThermocoupleOpen_7011(WORD wBuf[], float fBuf[],char szSend[],  
                             char szReceive[])
```

Parameter:

wBuf: WORD Input/Output argument talbe
wBuf[0] : [Input] COM port number, from 1 to 255
wBuf[1] : [Input] Module address, form 0x00 to 0xFF
wBuf[2] : [Input] Module ID, 0x7011
wBuf[3] : [Input] 0= Checksum disable; 1= Checksum enable
wBuf[4] : [Input] Timeout setting , normal=100 msecond
wBuf[5] : [Output] response value 0 → the thermocouple is close
 response value 1 → the thermocouple is open
wBuf[6] : [Input] 0 → no save to szSend & szReceive
 1 → Save to szSend & szReceive
fBuf : Not used.
szSend : [Input] Command string to be sent to I-7000 series modules.
szReceive : [Output] Result string receiving from I-7000 series modules .

Return Value:

0 is for Success
Not 0 is for Failure

Example:

```
WORD state;  
float fBuf[12];  
char szSend[80];  
char szReceive[80];  
WORD wBuf[12];  
WORD m_port=3;  
WORD m_address=1;
```



```

WORD m_timeout=100;
WORD m_checksum=0;
Open_Com(COM3, 9600, Data8Bit, NonParity, OneStopBit);
wBuf[0] = m_port;
wBuf[1] = m_address;
wBuf[2] = 0x7011;
wBuf[3] = m_checksum;
wBuf[4] = m_timeout;
wBuf[5] = 0;
wBuf[6] = 1;
ThermocoupleOpen_7011(wBuf, fBuf, szSend, szReceive);
state = wBuf[5];
Close_Com(COM3);

```

Remark:

■ SetLedDisplay

Description:

This function is used to configure LED display for specified channel of I-7000 analog input serial modules.

Syntax:

[C]
WORD SetLedDisplay (WORD wBuf[], float fBuf[], char szSend[], char szReceive[])

Parameter:

wBuf: WORD Input/Output argument talbe

wBuf[0] : [Input] COM port number, from 1 to 255

wBuf[1] : [Input] Module address, form 0x00 to 0xFF

wBuf[2] : [Input] Module ID, 0x7013/16/33

wBuf[3] : [Input] 0= Checksum disable; 1= Checksum enable

wBuf[4] : [Input] Timeout setting , normal=100 msecond

wBuf[5] : [Input] Set display channel

wBuf[6] : [Input] 0 → no save to szSend & szReceive
 1 → Save to szSend & szReceive
fBuf : Not used.
szSend : [Input] Command string to be sent to I-7000 series modules.
szReceive : [Output] Result string receiving from I-7000 series modules .

Return Value:

0 is for Success
Not 0 is for Failure

Example:

```
float fBuf[12];
char szSend[80];
char szReceive[80];
WORD wBuf[12];
WORD m_port=3;
WORD m_address=1;
WORD m_timeout=100;
WORD m_checksum=0;
Open_Com(COM3, 9600, Data8Bit, NonParity, OneStopBit);
wBuf[0] = m_port;
wBuf[1] = m_address;
wBuf[2] = 0x7033;
wBuf[3] = m_checksum;
wBuf[4] = m_timeout;
wBuf[5] = 1;           // Set channel 1 display
wBuf[6] = 1;
SetLedDisplay (wBuf, fBuf, szSend, szReceive);
Close_Com(COM3);
```

Remark:

■ GetLedDisplay

Description:

This function is used to get the current setting of the specified channel for LED display channel for specified channel of I-7000 analog input serial modules.

Syntax:

[C]
WORD GetLedDisplay (WORD wBuf[], float fBuf[],char szSend[], char szReceive[])

Parameter:

wBuf: WORD Input/Output argument talbe

wBuf[0] : [Input] COM port number, from 1 to 255

wBuf[1] : [Input] Module address, form 0x00 to 0xFF

wBuf[2] : [Input] Module ID, 0x7013/16/33

wBuf[3] : [Input] 0= Checksum disable; 1= Checksum enable

wBuf[4] : [Input] Timeout setting , normal=100 msecond

wBuf[5] : [Output] Current channel for LED display
0 = channel_0
1 = channel_1

wBuf[6] : [Input] 0 → no save to szSend & szReceive
1 → Save to szSend & szReceive

fBuf : Not used

szSend : [Input] Command string to be sent to I-7000 series modules.

szReceive : [Output] Result string receiving from I-7000 series modules .

Return Value:

0 is for Success

Not 0 is for Failure

Example:

```
WORD led;  
float fBuf[12];  
char szSend[80];  
char szReceive[80];  
WORD wBuf[12];  
WORD m_port=3;  
WORD m_address=1;  
WORD m_timeout=100;  
WORD m_checksum=0;  
Open_Com(COM3, 9600, Data8Bit, NonParity, OneStopBit);
```

```
wBuf[0] = m_port;  
wBuf[1] = m_address;  
wBuf[2] = 0x7033;  
wBuf[3] = m_checksum;  
wBuf[4] = m_timeout;  
wBuf[6] = 1;  
GetLedDisplay (wBuf, fBuf, szSend, szReceive);  
Led = wBuf[5];  
Close_Com(COM3);
```

Remark:

6.6 Analog Output Functions

6.6.1 I-7000 series modules

■ AnalogOut

Description:

This function is used to obtain analog value from analog output module of I-7000 series modules.

Syntax:

```
[ C ]  
WORD AnalogOut(WORD wBuf[], float fBuf[],char szSend[], char szReceive[])
```

Parameter:

wBuf: WORD Input/Output argument talbe
wBuf[0] : [Input] COM port number, from 1 to 255
wBuf[1] : [Input] Module address, form 0x00 to 0xFF
wBuf[2] : [Input] Module ID, 0x7016/21/22/24
wBuf[3] : [Input] 0= Checksum disable; 1= Checksum enable
wBuf[4] : [Input] Timeout setting , normal=100 msecond
wBuf[5] : [Input] The analog output channel number
wBuf[6] : [Input] 0 → no save to szSend &szReceive
 1 → Save to szSend &szReceive
fBuf : Float Input/Ouput argument table.
fBuf[0] : [Input] Analog output value
szSend : [Input] Command string to be sent to I-7000 series modules.
szReceive : [Output] Result string receiving from I-7000 series modules.

Return Value:

0 is for Success
Not 0 is for Failure

Example:

```
float fBuf[12];  
char szSend[80];  
char szReceive[80];  
WORD wBuf[12];  
WORD m_port=3;  
WORD m_address=1;  
WORD m_timeout=100;
```

```
WORD m_checksum=0;
Open_Com(COM3, 9600, Data8Bit, NonParity, OneStopBit);
wBuf[0] = m_port;
wBuf[1] = m_address;
wBuf[2] = 0x7016;
wBuf[3] = m_checksum;
wBuf[4] = m_timeout;
// wBuf[5] = 0; // I-7016 no used
wBuf[6] = 1;
fBuf[0] = 3.5 // Excitation Voltage output +3.5V
AnalogOut (wBuf, fBuf, szSend, szReceive); "
Close_Com(COM3);
```

Remark:

■ AnalogOutReadBack

Description:

This function is used to obtain read back the analog value of analog output modules of I-7000 series modules. There are two types of read back functions, as described in the following :

1. Last value is read back by \$AA6 command
2. Analog output of current path is read back by \$AA8 command

Syntax:

```
[ C ]  
WORD AnalogOutReadBack(WORD wBuf[], float fBuf[],char szSend[],  
                        char szReceive[])
```

Parameter:

wBuf: WORD Input/Output argument talbe
wBuf[0] : [Input] COM port number, from 1 to 255
wBuf[1] : [Input] Module address, form 0x00 to 0xFF
wBuf[2] : [Input] Module ID, 0x7016/21/22/24
wBuf[3] : [Input] 0= Checksum disable; 1= Checksum enable
wBuf[4] : [Input] Timeout setting , normal=100 msecond
wBuf[5] : [Input] 0 : command \$AA6 read back
 1 : command \$AA8 read back

Note 1) When the module is I-7016: Don't care.
 2) When the module is I-7021/22, analog output of current path read back (\$AA8)
 3) When the module is I-7024, the updating value in a specific Slew rate (\$AA8)
 (For more information, please refer to I-7021/22/24 manual)

wBuf[6] : [Input] 0 → no save to szSend &szReceive
 1 → Save to szSend &szReceive
wBuf[7] : [Input] The analog output channel No. (0~3) of module I-7024
 No used for single analog output module
fBuf : Float Input/Ouput argument table.
fBuf[0] : [Output] Analog output read back value
szSend : [Input] Command string to be sent to I-7000 series modules.
szReceive : [Output] Result string receiving from I-7000 series modules.

Return Value:

0 is for Success

Not 0 is for Failure

Example:

```
Float Volt;
float fBuf[12];
char szSend[80];
char szReceive[80];
WORD wBuf[12];
WORD m_port=3;
WORD m_address=1;
WORD m_timeout=100;
WORD m_checksum=0;
Open_Com(COM3, 9600, Data8Bit, NonParity, OneStopBit);
wBuf[0] = m_port;
wBuf[1] = m_address;
wBuf[2] = 0x7021;
wBuf[3] = m_checksum;
wBuf[4] = m_timeout;
wBuf[5] = 0;                // $AA6 command
wBuf[6] = 1;
wBuf[7] = 1;
AnalogOutReadBack (wBuf, fBuf, szSend, szReceive);
Volt = fBuf[0];            // Receive: "!01+2.57" excitation voltage , Volt=2.57
Close_Com(COM3);
```

Remark:

■ AnalogOutHex

Description:

This function is used to obtain analog value of analog output modules through Hex format.

Syntax:

[C]

`WORD AnalogOutHex(WORD wBuf[], float fBuf[],char szSend[], char szReceive[])`

Parameter:

wBuf: WORD Input/Output argument talbe

wBuf[0] : [Input] COM port number, from 1 to 255

wBuf[1] : [Input] Module address, form 0x00 to 0xFF

wBuf[2] : [Input] Module ID, 0x7021/21P/22

wBuf[3] : [Input] 0= Checksum disable; 1= Checksum enable

wBuf[4] : [Input] Timeout setting , normal=100 msecond

wBuf[5] : [Input] The analog output channel number
(No used for single analog output module)

wBuf[6] : [Input] 0 → no save to szSend &szReceive
1 → Save to szSend &szReceive

wBuf[7] : [Input] Analog output value in Hexadecimal data format

fBuf : Not used.

szSend : [Input] Command string to be sent to I-7000 series modules.

szReceive : [Output] Result string receiving from I-7000 series modules.

Return Value:

0 is for Success
Not 0 is for Failure

Example:

```
float fBuf[12];
char szSend[80];
char szReceive[80];
WORD wBuf[12];
WORD m_port=3;
WORD m_address=1;
WORD m_timeout=100;
WORD m_checksum=0;
Open_Com(COM3, 9600, Data8Bit, NonParity, OneStopBit);
```

```

wBuf[0] = m_port;
wBuf[1] = m_address;
wBuf[2] = 0x7022;
wBuf[3] = m_checksum;
wBuf[4] = m_timeout;
wBuf[5] = 1;           // channel 1
wBuf[6] = 1;
wBuf[7] = 0x250
AnalogOutHex (wBuf, fBuf, szSend, szReceive);
Close_Com(COM3);

```

Remark:

■ AnalogOutFsr

Description:

This function is used to obtain analog value of analog output modules through % of span data format. This function only can be used after analog output modules is set as “FSR” output mode.

Syntax:

[C]
WORD AnalogOutFsr(WORD wBuf[], float fBuf[],char szSend[], char szReceive[])

Parameter:

wBuf: WORD Input/Output argument talbe

wBuf[0] : [Input] COM port number, from 1 to 255

wBuf[1] : [Input] Module address, form 0x00 to 0xFF

wBuf[2] : [Input] Module ID, 0x7021/21P/22

wBuf[3] : [Input] 0= Checksum disable; 1= Checksum enable

wBuf[4] : [Input] Timeout setting , normal=100 msecond

wBuf[5] : [Input] The analog output channel number
(No used for single analog output module)

wBuf[6] : [Input] 0 → no save to szSend &szReceive
1 → Save to szSend &szReceive

fBuf : Float Input/Output argument table.

FBuf[0] : [Input] Analog output value in % of Span data format.
szSend : [Input] Command string to be sent to I-7000 series modules.
szReceive : [Output] Result string receiving from I-7000 series modules.

Return Value:

0 is for Success

Not 0 is for Failure

Example:

```
float fBuf[12];
char szSend[80];
char szReceive[80];
WORD wBuf[12];
WORD m_port=3;
WORD m_address=1;
WORD m_timeout=100;
WORD m_checksum=0;
Open_Com(COM3, 9600, Data8Bit, NonParity, OneStopBit);
wBuf[0] = m_port;
wBuf[1] = m_address;
wBuf[2] = 0x7022;
wBuf[3] = m_checksum;
wBuf[4] = m_timeout;
wBuf[5] = 1;           // channel 1
wBuf[6] = 1;
fBuf[0] = 50
AnalogOutFsr (wBuf, fBuf, szSend, szReceive);  ”
Close_Com(COM3);
```

Remark:

■ AnalogOutReadBackHex

Description:

This function is used to obtain read back the analog value of analog output modules in Hex format for I-7000 series modules. There are two types of read back functions, as described in the following :

1. Last value is read back by \$AA6 command
2. Analog output of current path is read back by \$AA8 command

Syntax:

```
[ C ]  
WORD AnalogOutReadBackHex(WORD wBuf[], float fBuf[],char szSend[],  
                           char szReceive[])
```

Parameter:

wBuf: WORD Input/Output argument talbe

wBuf[0] : [Input] COM port number, from 1 to 255

wBuf[1] : [Input] Module address, form 0x00 to 0xFF

wBuf[2] : [Input] Module ID, 0x7021/21P/22

wBuf[3] : [Input] 0= Checksum disable; 1= Checksum enable

wBuf[4] : [Input] Timeout setting , normal=100 msecond

wBuf[5] : [Input] 0 : command \$AA6 read back
 1 : command \$AA8 read back

wBuf[6] : [Input] 0 → no save to szSend &szReceive
 1 → Save to szSend &szReceive

wBuf[7] : [Input] The analog output channel No.
 No used for single analog output module

wBuf[9] : [Output] Analog output value in Hexadecimal data format.

fBuf : Not used.

szSend : [Input] Command string to be sent to I-7000 series modules.

szReceive : [Output] Result string receiving from I-7000 series modules.

Return Value:

0 is for Success
Not 0 is for Failure

Example:

```
WORD Volt;  
float fBuf[12];  
char szSend[80];
```

```
char szReceive[80];
WORD wBuf[12];
WORD m_port=3;
WORD m_address=1;
WORD m_timeout=100;
WORD m_checksum=0;
Open_Com(COM3, 9600, Data8Bit, NonParity, OneStopBit);
wBuf[0] = m_port;
wBuf[1] = m_address;
wBuf[2] = 0x7021;
wBuf[3] = m_checksum;
wBuf[4] = m_timeout;
wBuf[5] = 0;                // command $AA6
wBuf[6] = 1;
wBuf[7] = 0;
AnalogOutReadBackHex (wBuf, fBuf, szSend, szReceive);
Volt = wBuf[9];
Close_Com(COM3);
```

Remark:

■ AnalogOutReadBackFsr

Description:

This function is used to obtain read back the analog value of analog output modules through % of span data format for I-7000 series modules. There are two types of read back functions, as described in the following :

1. Last value is read back by \$AA6 command
2. Analog output of current path is read back by \$AA8 command

Syntax:

```
[ C ]  
WORD AnalogOutReadBackFsr(WORD wBuf[], float fBuf[],char szSend[],  
char szReceive[])
```

Parameter:

wBuf: WORD Input/Output argument talbe

wBuf[0] : [Input] COM port number, from 1 to 255

wBuf[1] : [Input] Module address, form 0x00 to 0xFF

wBuf[2] : [Input] Module ID, 0x7021/21P/22

wBuf[3] : [Input] 0= Checksum disable; 1= Checksum enable

wBuf[4] : [Input] Timeout setting , normal=100 msecond

wBuf[5] : [Input] 0 : command \$AA6 read back
1 : command \$AA8 read back

wBuf[6] : [Input] 0 → no save to szSend &szReceive
1 → Save to szSend &szReceive

wBuf[7] : [Input] The analog output channel No.
No used for single analog output module

fBuf : Float input/output argument table.

fBuf[0] : [Output] Analog output value in % Span data format.

szSend : [Input] Command string to be sent to I-7000 series modules.

szReceive : [Output] Result string receiving from I-7000 series modules.

Return Value:

0 is for Success
Not 0 is for Failure

Example:

```
float Volt;  
float fBuf[12];  
char szSend[80];
```

```
char szReceive[80];
WORD wBuf[12];
WORD m_port=3;
WORD m_address=1;
WORD m_timeout=100;
WORD m_checksum=0;
Open_Com(COM3, 9600, Data8Bit, NonParity, OneStopBit);
wBuf[0] = m_port;
wBuf[1] = m_address;
wBuf[2] = 0x7021;
wBuf[3] = m_checksum;
wBuf[4] = m_timeout;
wBuf[5] = 0;                // command $AA6
wBuf[6] = 1;
wBuf[7] = 0;
AnalogOutReadBackFsr (wBuf, fBuf, szSend, szReceive);
Volt = fBuf[0];
Close_Com(COM3);
```

Remark:

6.7 Error Code Explanation

Error Code	Explanation
0	NoError
1	FunctionError
2	PortError
3	BaudrateError
4	DataError
5	StopError
6	ParityError
7	ChecksumError
8	ComPortNotOpen
9	SendThreadCreateError
10	SendCmdError
11	ReadComStatusError
12	StrCheck Error
13	CmdError
14	X
15	TimeOut
16	X
17	ModuleId Error
18	AdChannelError
19	UnderRang
20	ExceedRange
21	InvalidateCounterValue
22	InvalidateCounterValue
23	InvalidateGateMode
24	InvalidateChannelNo
25	ComPortInUse

7. Demo of LinPAC-51XX Modules With C Language

In this section, we will focus on examples for the description and application of the control functions on the I-7000/I-8000/I-87k series modules for use in the LinPAC-51XX. After you install the LinPAC-51XX SDK, all these demo programs as below are in the path of “**c:/cygwin/LinCon8k/examples**”.

7.1 I-7k Modules DIO Control Demo

This demo – **i7kdio.c** will illustrate how to control DI/DO with the I-7050 module (8 DO channels and 7 DI channels). The address and baudrate of the I-7050 module in the RS-485 network are 02 and 9600 separately.

The result of this demo allows the DO channels 0 ~ 7 output and DI channel 2 input. The source code of this demo program is as follows:

```
#include<stdio.h>
#include<stdlib.h>
#include "msw.h"

char szSend[80], szReceive[80], ans;
WORD wBuf[12];
float fBuf[12];

/* ----- */
int main()
{
    int wRetVal;
    // Check Open_Com2
    wRetVal = Open_Com(COM2, 9600, Data8Bit, NonParity, OneStopBit);
    if (wRetVal > 0) {
        printf("open port failed!\n");
        return (-1);
    }
}
```

```

// ***** 7050 DO && DI Parameter *****
wBuf[0] = 2;           // COM Port
wBuf[1] = 0x02;       // Address
wBuf[2] = 0x7050;     // ID
wBuf[3] = 0;          // CheckSum disable
wBuf[4] = 100;        // TimeOut , 100 msecond
wBuf[5] = 0x0f;       // 8 DO Channels On
wBuf[6] = 0;          // string debug
// 7050 DO Output
wRetVal = DigitalOut(wBuf, fBuf, szSend, szReceive);
if (wRetVal)
    printf("DigitalOut_7050 Error !, Error Code=%d\n", wRetVal);

printf("The DO of 7050 : %u \n", wBuf[5]);

// 7050 DI Input
DigitalIn(wBuf, fBuf, szSend, szReceive);
printf("The DI of 7050 : %u \n", wBuf[5]);

Close_Com(COM2);
return 0;
}

```

Follow the below steps to achieve the desired results :

STEP 1 : (**Write i7kdio.c**)

Copy the above source code and save it with the name - i7kdio.c or get the file from C:\cygwin\LinCon8k\examples\i7k.

STEP 2 : (**Compile i7kdio.c to i7kdio.exe**)

Here we will introduce two methods to accomplish step 2.

< **Method One** > **Using Batch File (lcc.bat)**

Execute Start>Programs>ICPDAS>LinPAC-51XX SDK> LinPAC-51XX Build Environment to open LinPAC-51XX SDK and change the path to C:\cygwin\LinCon8k\examples\i7k. Then type **lcc i7kdio** to compile i7kdio.c to i7kdio.exe. (refer to Fig. 7-1)

```

C:\LinPAC-51XX Build Environment
C:\Documents and Settings\Eduard\Desktop>CMD.EXE /k c:\cygwin\lincon8k\setenv.bat
----- LinPAC-51XX SDK Environment Configure -----
Target      :ICPDAS          (Arm based)
Work Directory :C:\Cygwin\LinCon8k
C:\cygwin\LinCon8k>cd examples/i7k
C:\cygwin\LinCon8k\examples\i7k>lcc i7kdio
Compile ok!
C:\cygwin\LinCon8k\examples\i7k>dir/w
Volume in drive C has no label.
Volume Serial Number is 6CF3-2221

Directory of C:\cygwin\LinCon8k\examples\i7k

[.]          [..]          i7kaio.c      i7kaio.exe   i7kdio.c     i7kdio.exe
          4 File(s)          549,049 bytes
          2 Dir(s)  13,700,902,912 bytes free
C:\cygwin\LinCon8k\examples\i7k>

```

Fig. 7-1

< Method Two > Using Compile Instruction

If you choose this method, change the path to C:\cygwin\LinCon8k\examples\i7k and then type arm-linux-gcc -I../include -lm -o i7kdio.exe i7kdio.c ../lib/libi8k.a to compile i7kdio.c to i7kdio.exe. (refer to Fig. 7-2)

```

C:\LinPAC-51XX Build Environment
C:\Documents and Settings\Eduard\Desktop>CMD.EXE /k c:\cygwin\lincon8k\setenv.bat
----- LinPAC-51XX SDK Environment Configure -----
Target      :ICPDAS          (Arm based)
Work Directory :C:\Cygwin\LinCon8k
C:\cygwin\LinCon8k>cd examples/i7k
C:\cygwin\LinCon8k\examples\i7k>arm-linux-gcc -I../include -lm -o i7kdio.exe
i7kdio.c ../lib/libi8k.a
C:\cygwin\LinCon8k\examples\i7k>dir/w
Volume in drive C has no label.
Volume Serial Number is 6CF3-2221

Directory of C:\cygwin\LinCon8k\examples\i7k

[.]          [..]          i7kaio.c      i7kaio.exe   i7kdio.c     i7kdio.exe
          4 File(s)          549,049 bytes
          2 Dir(s)  13,700,501,504 bytes free
C:\cygwin\LinCon8k\examples\i7k>

```

Fig. 7-2

STEP 3 : (Transfer i7kdio.exe to the LinPAC-51XX)

Here we introduce two methods for achieving this purpose.

< Method One > Using FTP Software

(1) Open a FTP Software and add a ftp site of the LinPAC-51XX. The **User_Name** and **Password** default value is “ root ”. Then click the “**Connect**” button to connect to the ftp server of the LinPAC-51XX. (refer to Fig.7-3).

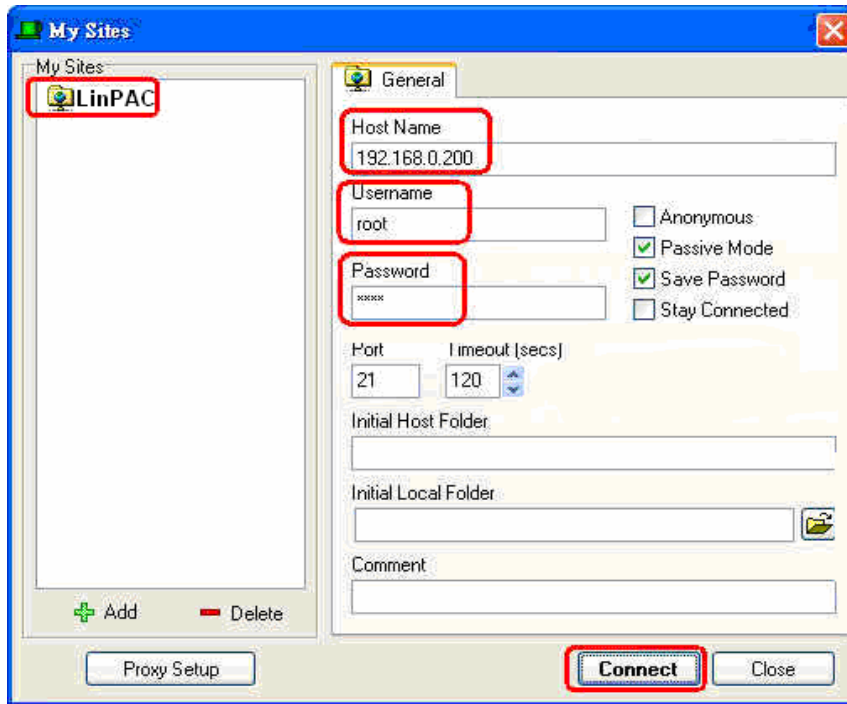

Fig.7-3

(2) Upload the file – **i7kdio.exe** to the LinPAC-51XX. (refer to Fig.7-4).

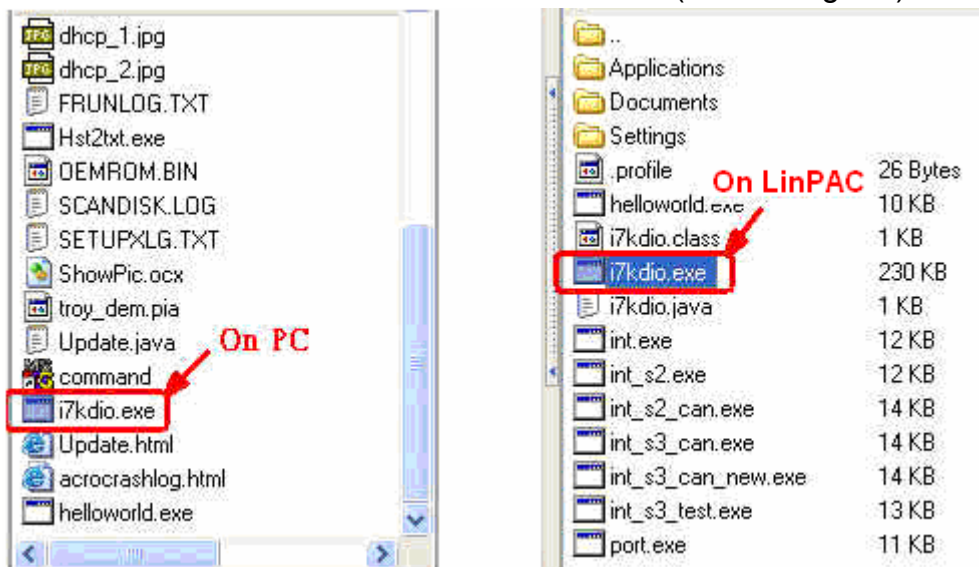

Fig.7-4

(3) Choose i7kdio.exe in the LinPAC-51XX and click the right mouse button to choose the “ **Permission** ”option. Then type 777 into the Numeric blank textbox. (refer to Fig.7-5 and refer to Fig.7-6).

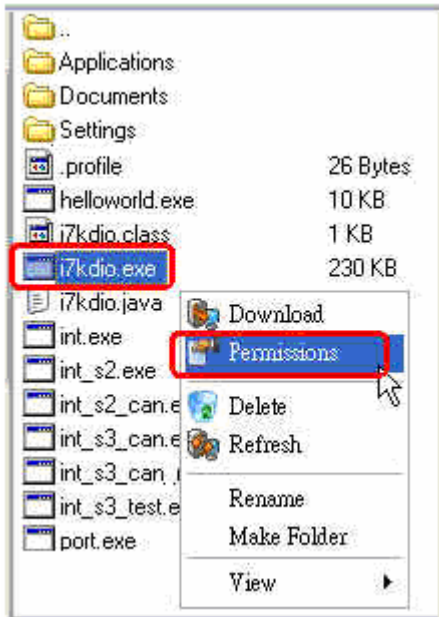

Fig.7-5

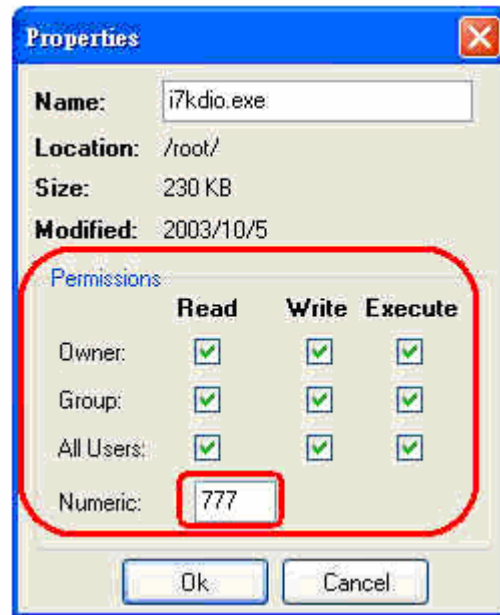

Fig.7-6

< Method Two > Using DOS Command Prompt

Open DOS Command Prompt and type ftp IP Address of LinPAC-51XX in order to connect to the ftp server of the LinPAC-51XX. Then input **User Name** and **Password (root** is the default value) to login to the LinPAC-51XX. Type **bin** to make the file transference in “binary” mode.

Then type put c:/cygwin/lincon8k/examples/i7k/i7kdio.exe i7kdio.exe to transfer the i7kdio.exe to the LinPAC-51XX. After the “Transfer complete” message appears, the process of transference would have been completed.(refer to Fig. 7-7)

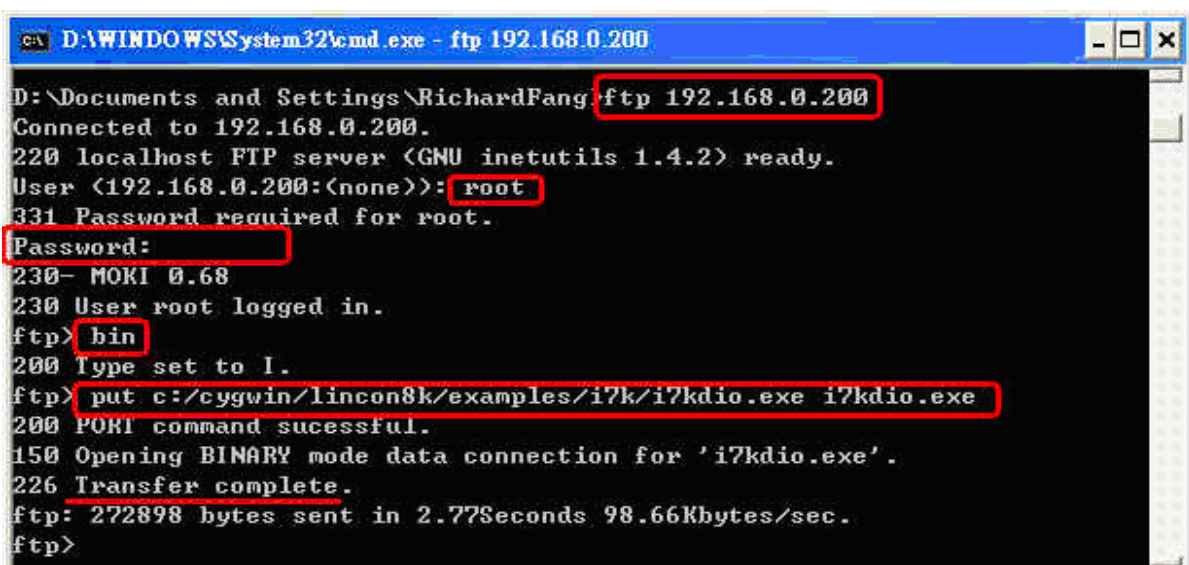

Fig. 7-7

STEP 4 : (Telnet to the LinPAC-51XX to execute i7kdio.exe)

Type telnet IP Address of LinPAC-51XX into the remote control the LinPAC-51XX and input your **User Name** and **Password** (**root** is the default value) to login to the LinPAC-51XX. And then type chmod 777 i7kdio.exe to make i7kdio.exe executable. Type i7kdio.exe to execute i7kdio.exe. (refer to Fig. 7-8 and Fig. 7-9)

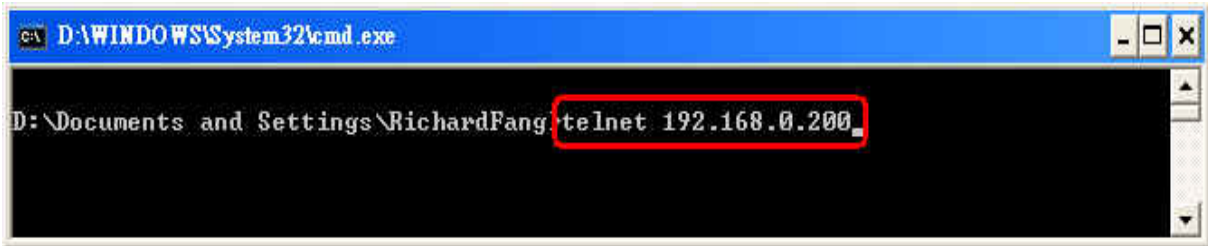

Fig. 7-8

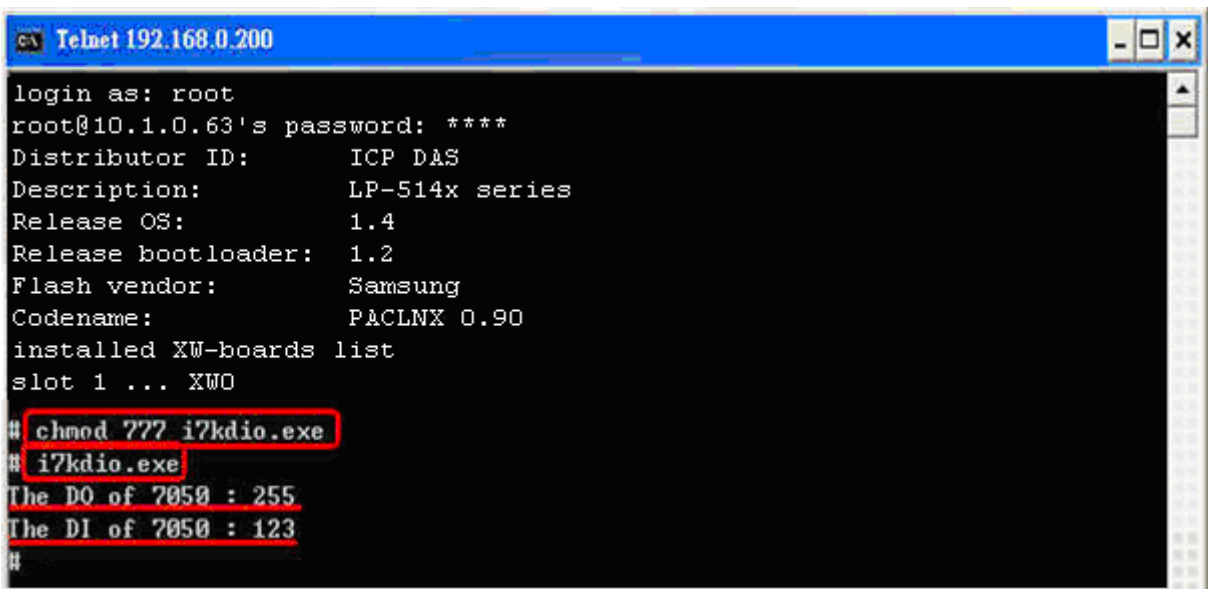

Fig. 7-9

“ **The DO of I-7050 : 255 (= 2^8-1)**” means DO channel 0 ~ 7 will output and “ **The DI of I-7050 : 123 (= $127-2^2$)**” means there is input in DI channel 2.

7.2 I-7k Modules AIO Control Demo

This demo – **i7kaio.c** will illustrate how to control the AI/AO with the I-7017 (8 AI channels) and I-7021 modules (1 AO channel). The address for the I-7021 and I-7017 modules are in the RS-485 network where 05 and 03 are separate and the baudrate is 9600.

The result of this demo allows the I-7021 module's AO channel to output 3.5V and the I-7017 's AI channel 2 to input. The source code of this demo program is as follows :

```
#include<stdio.h>
#include<stdlib.h>
#include "msw.h"

char szSend[80], szReceive[80];
WORD wBuf[12];
float fBuf[12];
/* ----- */

int main()
{
    int i,j, wRetVal;
    DWORD temp;

    wRetVal = Open_Com(COM2, 9600, Data8Bit, NonParity, OneStopBit);
    if (wRetVal > 0) {
        printf("open port failed!\n");
        return (-1);
    }

    //--- Analog output ---- **** 7021 -- AO ****
    i = 0;
    wBuf[0] = 2;           // COM Port
    wBuf[1] = 0x05;        // Address
    wBuf[2] = 0x7021;      // ID
    wBuf[3] = 0;           // CheckSum disable
    wBuf[4] = 100;         // TimeOut , 100 msecond
    //wBuf[5] = i;         // Not used if module ID is 7016/7021
                           // Channel No.(0 to 1) if module ID is 7022
                           // Channel No.(0 to 3) if module ID is 7024

    wBuf[6] = 0;           // string debug
    fBuf[0] = 3.5;         // Analog Value
```

```

wRetVal = AnalogOut(wBuf, fBuf, szSend, szReceive);
if (wRetVal)
    printf("AO of 7021 Error !, Error Code=%d\n", wRetVal);
else
    printf("AO of 7021 channel %d = %f \n",i,fBuf[0]);

//--- Analog Input ----   ****   7017 -- AI   ****
j = 1;
wBuf[0] = 2;                // COM Port
wBuf[1] = 0x03;             // Address
wBuf[2] = 0x7017;           // ID
wBuf[3] = 0;                // CheckSum disable
wBuf[4] = 100;              // TimeOut , 100 msecond
wBuf[5] = j;                // Channel of AI
wBuf[6] = 0;                // string debug
wRetVal = AnalogIn(wBuf, fBuf, szSend, szReceive);

if (wRetVal)
    printf("AI of 7017 Error !, Error Code=%d\n", wRetVal);
else
    printf("AI of 7017 channel %d = %f \n",j,fBuf[0]);

Close_Com(COM2);

return 0;
}

```

All the steps from programming to execution are the same as those in the section 7.1. The result of execution refers to Fig. 7-10.

```

Telnet 192.168.0.200
login as: root
root@10.1.0.63's password: ****
Distributor ID:      ICP DAS
Description:         LP-514x series
Release OS:          1.4
Release bootloader:  1.2
Flash vendor:        Samsung
Codename:            PACLNx 0.90
installed XW-boards list
slot 1 ... XWO
# i7kaio.exe
AO of 7021 channel 0 = 3.500000
AI of 7012 channel 1 = 3.500000

```

Fig. 7-10

7.3 Conclusion of Module Control Demo

Fig. 7-17 is the table of communication functions for the I-7000/I-8000/I-87000 modules in different locations. When using the ICP DAS modules in the LinPAC-51XX, this table will be helpful to let users understand which functions of communication should be used.

Module Location Communication Functions	I-87k in Expansion Unit	I-8k or I-87k in I-8000 Controller	I-7k
Open_Com()	✓	✓	✓
Close_Com()	✓	✓	✓

Fig. 7-17

Fig. 7-18 is the table of source files for the I-7000/I-8000/I-87000 modules in different locations. When plug-in ICP DAS modules in the LinPAC-51XX, this table will be helpful to let users understand which source files of the libi8k.a should be called.

Module Location Source File	I7000.c	I8000.c	I87000.c
I-7K	✓		
I-8K or I-87K in I-8000 Controller		✓	
I-87K in Expansion Unit			✓

Fig. 7-18

7.4 Timer Function Demo

If users want to use “**Timer**” function in the LinPAC-51XX, please refer to the demo – timer.c and time2.c in the SDK — (C:\cygwin\LinCon8k\examples\common). **timer.c** is for the execution period between 0.5~10 ms (Real-Time) and **timer2.c** is for the execution period more than 10 ms (General).

8. Introduction of LinPAC-51XX Serial Ports

This section describes the function of the three serial ports (RS-232/RS-485 interface) in the LinPAC-51XX embedded controller (see Fig 8-1). The information in this section is organized as follows:

- **COM1 Port** – Internal communication with the XW-board modules
- **COM2 Port** – RS-485 (D2+,D2-) ; 2500V_{DC} isolation
- **COM3 Port** – RS-232 (RXD, TXD and GND) ; Non-isolation
- **Console Port** – RS-232 (RXD, TXD, and GND) ; Non-isolation (For console)

COM port	Definitions in LinPAC-51XX SDK	Device name	Default baudrate
None	COM1	None	115200
1 (RS-232/console)	None	ttySA0	115200
2 (RS-485)	COM2	ttyS0	9600
3 (RS-232)	COM3	ttyS1	115200

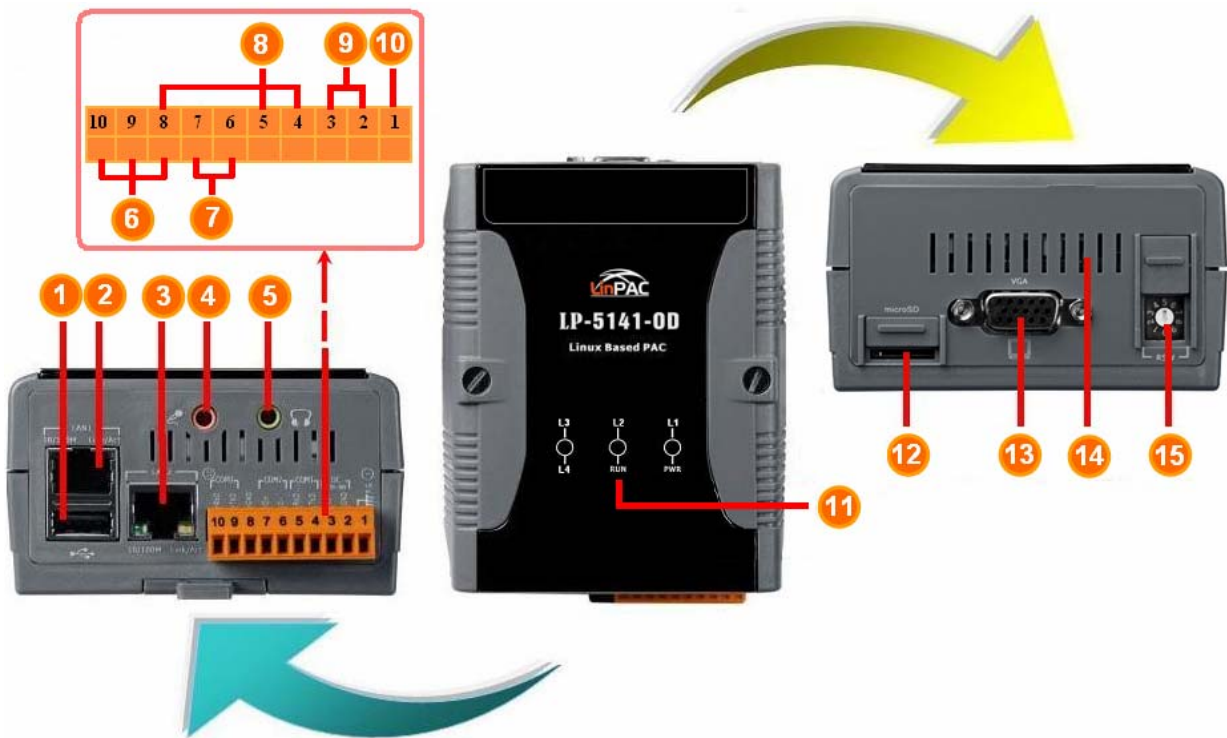

1	USB Port	6	COM 1 (RS-232)	11	LED Indicator
2	Ethernet Port 1	7	COM 2 (RS-485)	12	microSD socket
3	USB Port	8	COM 3 (RS-232)	13	VGA Port
4	Microphone-In	9	Power	14	XWboard (optional)
5	Earphone-Out	10	Frame Ground	15	Operating Modes Selector

Fig. 8-1

User can try the **stty** command to query or setting COM port. For example, to modify baudrate 9600 to 115200 via COM2 port:

```
# stty -F /dev/ttyS0 ispeed 115200 ospeed 115200
```

8.1 Introduction of COM1 Port of LinPAC-51XX

COM1 is an internal I/O expansion port of the LinPAC-51XX. This port is used to connect the I/O expansion board(XW-board) plugged into the LinPAC-51XX embedded controller. Users must use the serial command to control the I/O expansion board. For controlling the I/O expansion board, you must input the Com-port parameters and call the **Open_Com** function to open the com1 port based on the appropriate settings. This is like the serial address, and you can send out the control commands to the I/O module which is plugged into this slot. Therefore the module's serial address for its slot is **0**. A detailed example is provided below:

For Example:

```
int slot=1;
unsigned char port=1;
// for all modules in com1 port of LinPAC-51XX
DWORD baudrate=115200;
char data=8, parity=0, stopbit=1 ;
Open_Slot(slot);
Open_Com(port, baudrate, data, parity, stopbit);
// send command...
Close_Com(port);
Close_Slot(slot);
```

8.2 Introduction of COM2 Port of LinPAC-51XX

This COM2 port provides RS-485 serial communication (DATA+ and DATA-) and is located on bottom-right corner in the LinPAC-51XX. You can connect to the RS-485 device with modules like the I-7000 serial modules(DCON Module) via this port. That is, you can control the ICP DAS's modules directly from this port with any converter. ICP DAS will provide very easy to use functions with libi8k.a and then you can easily handle the I-7000 series modules. Below is an example of the program code demo.

❑ Test by C language:

```
unsigned char port=2; data=8, parity=0, stopbit=1;
DWORD baudrate=9600;
Open_Com(port, baudrate, data, char parity, stopbit);
// send command...
Close_Com(port);
```

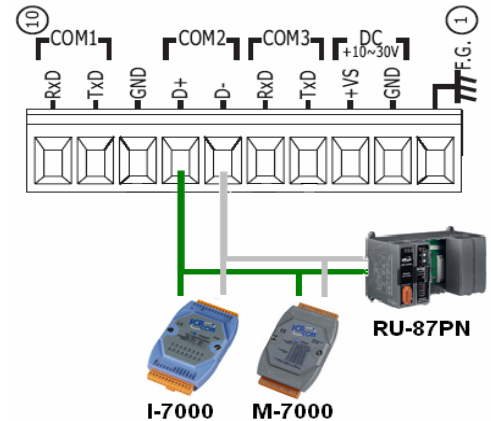

❑ Test in command line: (PC ↔ i-7520 ↔ COM2 of LinPAC-51XX)

A) Open “**Hyper Terminal**” of PC to monitor the process of update and the default COM2 port setting is 9600, 8, N, 1

B) Send data via COM2 port:

In LinPAC-51XX:

Type command: **echo send-485>/dev/ttyS0**

And, user can see the “send-485” in “Hyper Terminal” of PC

C) Receive data via COM2 port:

In LinPAC-51XX: Type command: **cat /dev/ttyS0**

In PC: User can enter some words in “Hyper Terminal” of PC, and user can see some words in LinPAC-51XX at same time.

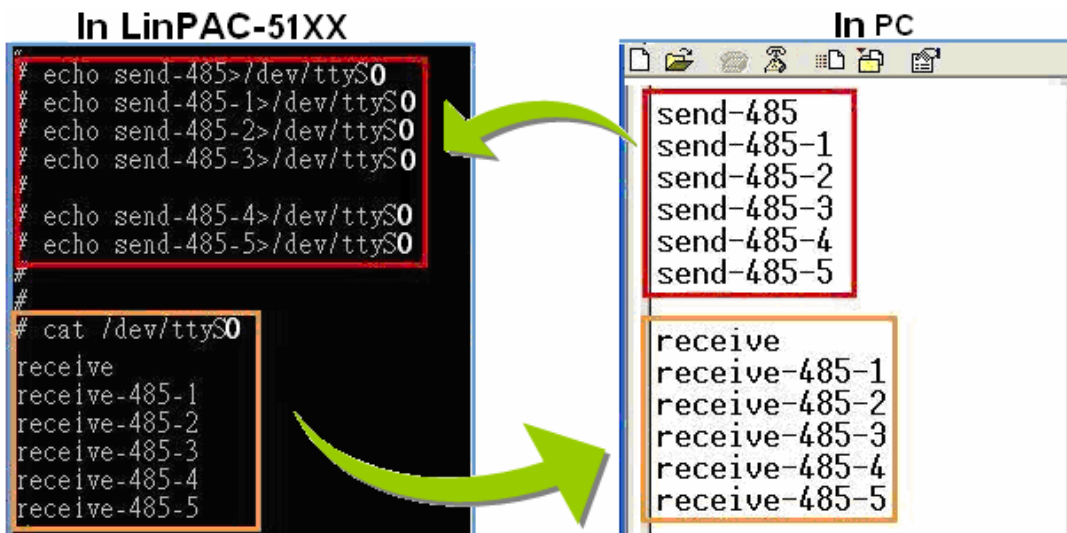

8.3 Introduction of COM3 Port of LinPAC-51XX

This COM3 port is located on the right-upper corner on the LinPAC-51XX. It is a standard **RS-232** serial port, and it provides TXD, RXD, GND, non-isolated. It can also connect to the I-7520 module in order to provide a general RS-485 communication. The COM3 port can also connect to a wireless modem so that it can be controlled from a remote device. The application example and code is demonstrated below:

❑ Test by C language:

```
unsigned char port=3; data=8, parity=0, stopbit=1;
DWORD baudrate=9600;
Open_Com(port, baudrate, data, parity, stopbit);
// send command...
Close_Com(port);
```

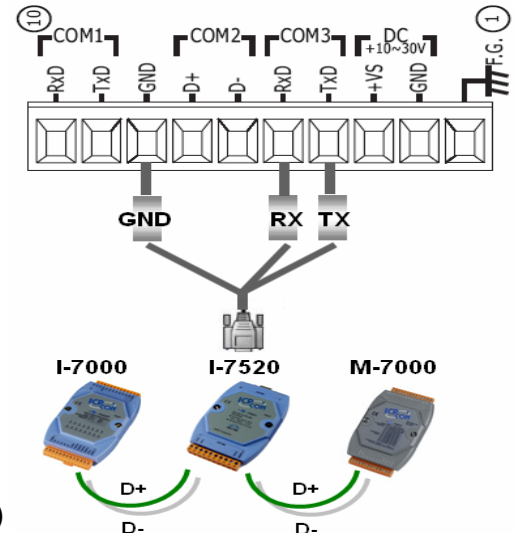

❑ Test in command line: (PC ↔ COM3 of LinPAC-51XX)

A) Open “**Hyper Terminal**” of PC to monitor the process of update and the default COM3 port setting is 9600, 8, N, 1

B) Send data via COM3 port:

In LinPAC-51XX:

Type command: **echo send-232>/dev/ttyS1**

And, user can see the “send-232” in “Hyper Terminal” of PC

C) Receive data via COM3 port:

In LinPAC-51XX: Type command: **cat /dev/ttyS1**

In PC: User can enter some words in “Hyper Terminal” of PC, and user can see some words in LinPAC-51XX.

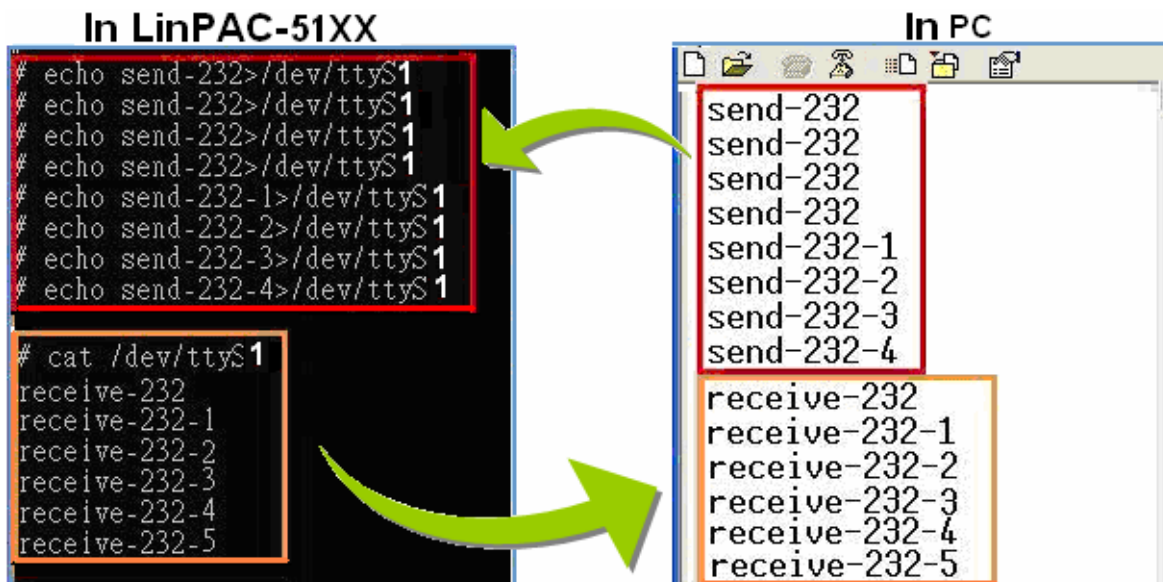

9. LinPAC-51XX Library Reference in C Language

In this chapter, all the functions of **libi8k.a** will be listed to allow users to be able to look them up quickly.

9.1 List Of System Information Functions

```
int Open_Slot(int slot)
void Close_Slot(int slot)
int Open_Slot(void)
void Close_SlotAll(void)
void ChangeToSlot(char slot)
WORD Open_Com(char port, DWORD baudrate, char cData, char cParity, char cStop)
BOOL Close_Com(char port)
WORD Send_Receive_Cmd (char port, char szCmd[ ], char szResult[ ], WORD wTimeOut,
                       WORD wChksum, WORD *wT)
WORD Send_Cmd (char port, char szCmd[ ], WORD wTimeOut, WORD wChksum)
WORD Receive_Cmd (char port, char szResult[ ], WORD wTimeOut, WORD wChksum)
WORD Send_Binary(char port, char szCmd[ ], int iLen)
WORD Receive_Binary(char cPort, char szResult[], WORD wTimeOut, WORD wLen,
                   WORD *wT)

int sio_open(int slot)
int sio_close(int slot)
int sio_set_noncan(int port)
int GetModuleType(char slot)
void Read_SN(unsigned char serial_num[] )
int GetNameOfModule(char slot)
void setLED(unsigned int addr, unsigned int value)
int GetBackPlaneID()
int GetRotaryID()
float GetSDKversion(void)
```

9.2 List Of Digital Input/Output Functions

9.2.1 For I-7000 modules via serial port

`WORD` DigitalOut(`WORD` wBuf[], `float` fBuf[], `char` szSend[], `char` szReceive[])

`WORD` DigitalBitOut(`WORD` wBuf[], `float` fBuf[], `char` szSend[], `char` szReceive[])

`WORD` DigitalOutReadBack(`WORD` wBuf[], `float` fBuf[],`char` szSend[], `char` szReceive[])

`WORD` DigitalOut_7016(`WORD` wBuf[], `float` fBuf[], `char` szSend[],`char` szReceive[])

`WORD` DigitalIn(`WORD` wBuf[], `float` fBuf[], `char` szSend[], `char` szReceive[])

`WORD` DigitalInLatch(`WORD` wBuf[], `float` fBuf[], `char` szSend[], `char` szReceive[])

`WORD` ClearDigitalInLatch(`WORD` wBuf[], `float` fBuf[],`char` szSend[],`char` szReceive[])

`WORD` DigitalInCounterRead(`WORD` wBuf[], `float` fBuf[], `char` szSend[],`char` szReceive[])

`WORD` ClearDigitalInCounter(`WORD` wBuf[], `float` fBuf[],`char` szSend[],`char` szReceive[])

`WORD` ReadEventCounter(`WORD` wBuf[], `float` fBuf[],`char` szSend[],`char` szReceive[])

`WORD` ClearEventCounter(`WORD` wBuf[], `float` fBuf[], `char` szSend[],`char` szReceive[])

9.3 List Of Watch Dog Timer Functions

`void` EnableWDT(`unsigned int` msecond)

`void` DisableWDT(`void`)

`unsigned int` WatchDogSWEven(`void`)

`void` ClearWDTSWEven(`unsigned int` rcsr)

9.4 List Of EEPROM Read/Write Functions

`void` Enable_EEP(`void`)

`void` Disable_EEP(`void`)

`unsigned char` Read_EEP(`int` block, `int` offset)

`void` Write_EEP(`int` block, `int` offset, `unsigned char` data)

9.5 List Of Analog Input Functions

9.5.1 For I-7000 modules via serial port

`WORD` AnalogIn(wBuf, fBuf, szSend, szReceive)

`WORD` AnalogInHex(wBuf, fBuf, szSend, szReceive)

`WORD` AnalogInFsr (wBuf, fBuf, szSend, szReceive)

WORD AnalogInAll (wBuf, fBuf, szSend, szReceive)
WORD ThermocoupleOpen_7011(wBuf, fBuf, szSend, szReceive)
WORD SetLedDisplay (wBuf, fBuf, szSend, szReceive)
WORD GetLedDisplay (wBuf, fBuf, szSend, szReceive)

9.6 List Of Analog Output Functions

9.6.1 For I-7000 modules via serial port

WORD AnalogOut(wBuf, fBuf, szSend, szReceive);
WORD AnalogOutReadBack(wBuf, fBuf, szSend, szReceive)
WORD AnalogOutHex(wBuf, fBuf, szSend, szReceive)
WORD AnalogOutFsr(wBuf, fBuf, szSend, szReceive)
WORD AnalogOutReadBackHex(wBuf, fBuf, szSend, szReceive)
WORD AnalogOutReadBackFsr(wBuf, fBuf, szSend, szReceive)

10. Additional Support

In this chapter, ICP DAS provides extra module supported and instructions to enhance LinPAC-51XX functionality and affinity.

10.1 GUI Funtion Support

Now “X-window“ is supported the **VGA** solution and when the LinPAC-51XX boot up, the GUI like “**Windows screen**” will show up. The most important thing is that users can write GUI programs and run them in the LinPAC-51XX. The GUI Library in the LinPAC-51XX is provided with **GTK+ v1.2 & v2.0** Library. Therefore users can design their own “**SCADA**” screen by the GTK+ Library in the LinPAC-51XX. In the meanwhile, we provide some GUI demo programs to control I/O modules of ICP DAS and assist users to develop own GUI programs quickly. These demo programs are placed in the path – **C:\cygwin\LinCon8k\examples\gui** after users install the LinPAC-51XX SDK. (Refer to the Fig. 10-1)

Except GTK+ GUI Function, “**Java GUI**” is also supported in the LinPAC-51XX. So if users are familiar with Java, users can also use Java to develop own GUI programs. But just Awe and Swing v1.1 elements below are supported in the LinPAC-51XX. To execute Java GUI program – Stylepad.jar in the LinPAC-51XX, users just type in “**java -jar Stylepad.jar -cp .:Stylepad.jar**”. Then it will take some time to run up the Java GUI program.

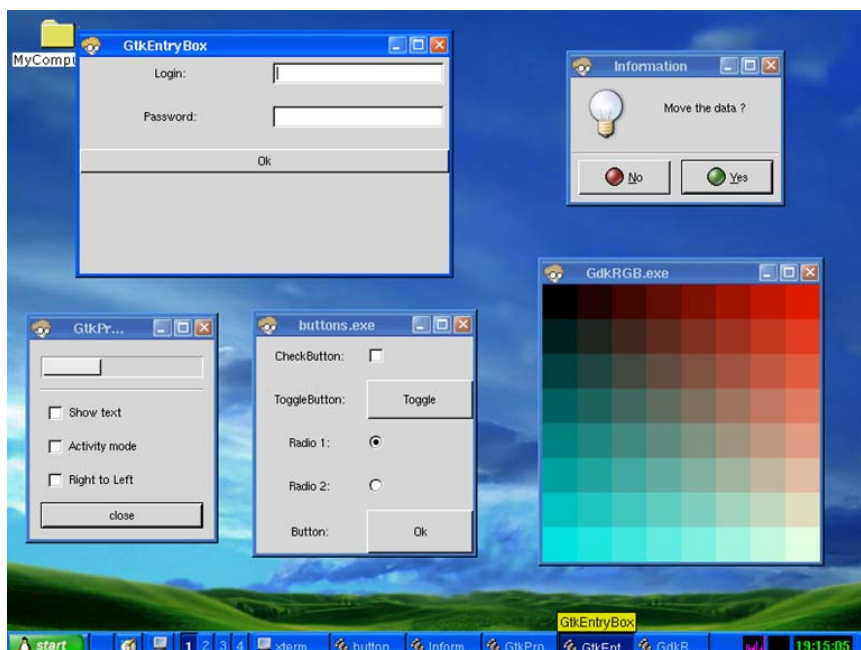

Fig. 10-1

10.1.1 Disable X-window

LinPAC-51XX can boot without loading X-window by the steps as follows :

- (1) Type “**cd /etc/rc2.d**” to into default run level.
- (2) Type ”**ls -al**” to see the S98Xserver link into ../init.d/startx.
- (3) Type ”**mv S98Xserver Xs98Xserver**” to rename the S98Xserver for turn off X-window. Then exit and reboot LinPAC-51XX.

10.1.2 Enable X-window

If you type the “**ls -al /etc/rc2.d**” that can fine the link about ../init.d/startx, and then type the “**mv XS98Xserver S98Xserver** “ to rename the Xs98Xserver for turn on X-window or else if you can't fine any link about ../init.d/startx, and please follow the below steps :

- (1) Type “**cd /etc/rc2.d**” to into default run level.
- (2) Type ”**ln -s ../init.d/startx /etc/rc2.d/S98Xserver**” to make a symbolic link into the script file of X-window for turn on X-window. Then exit and reboot LinPAC-51XX.

10.2 ScreenShot Support

There is a screenshot program – “**fbshot**” built in to let users to catch the LinPAC-51XX screen conveniently. Users just type in “**fbshot -d /dev/fb0 /mnt/hda/catch1.png**” and the screen will be caught and saved to the file – /mnt/hda/catch1.png. If users want to take a look the picture, just type in “**vi /mnt/hda/catch1.png**”. (Note : vi is placed in the path : /mnt/hda/opt/bin so users need to plug microSD card in the LinPAC-51XX first.) If users want to know the detailed parameters of fbshot, just type in “**fbshot -help**”.

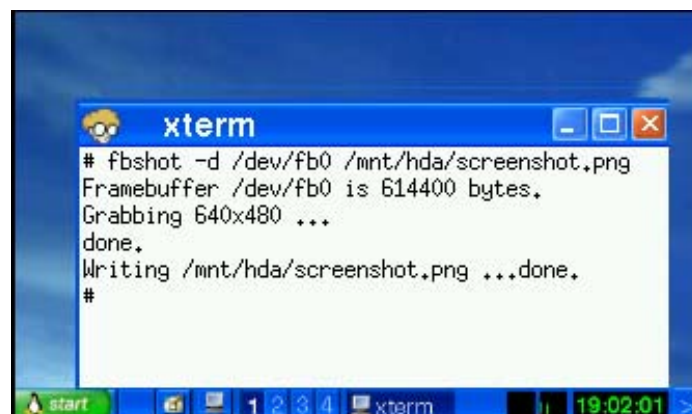

10.3 WebCAM Support

WebCAM is also supported in the LinPAC-51XX and Logitech brand works successfully now. Other brands will need to do a test. Please follow the steps to make the Webcam work smoothly :

- (1) Connect the webcam to the LinPAC-51XX with “**USB Interface**”.
- (2) Reboot the LinPAC-51XX.
- (3) Open a “**Command Prompt**”. Type in “**insmod pwc.ko**” to load the gqcam program decompressor and then type in “**gqcam**” to see the webcam screen. If users want to know the detailed parameters of gqcam, just type in “**gqcam –help**”.

To catch the picture through webcam, users can use gqcam program to do that. Please follow the steps as below :

- (1) Click “**File/Save Image...**”
- (2) At “**Gqcam: Save Image**” screen, input the path and file name in the “**File Field**” and then click “OK” button.

10.4 Touch Screen Support

There are five steps to adjusting the touch screen calibration with LinPAC-51XX:

STEP1: Make sure the **usbtouchscreen.ko** and **penmount.ko** were mounted. (Refer to the Fig. 10-2)

```
# lsmod
Module                Size  Used by    Tainted: P
tsdev                 10024  0
usbtouchscreen       9284   0
penmount              3968   0
8250                  29204  0
8250_linpac           2656   0 [permanent]
slot                  35788  0
pxamci                8352   0
dm9000x              276180  0
#
```

Fig. 10-2

STEP2: Make sure the microSD card was mounted, which is include **opt** dictionary.
(Refer to the Fig. 10-3)

```
# mount
rootfs on / type rootfs (rw)
/dev/root on / type jffs2 (rw)
proc on /proc type proc (rw)
sysfs on /sys type sysfs (rw)
tmpfs on /var type tmpfs (rw)
shmfs on /dev/shm type tmpfs (rw)
usbfs on /proc/bus/usb type usbfs (rw)
/dev/mmcblk0p1 on /mnt/hda type vfat (rw,umask=0022,dmasks=0022,codepage=cp437,iocharset=iso8859-1)
/dev/ram0 on /mnt/ramfs type minix (rw)
#
```

Fig. 10-3

STEP3: Users can edit the file : **/etc/init.d/fbman** to modify the setting as below:

- ❑ When users open the file : **/etc/init.d/fbman**, users can see the following lines :

```
#!/usr/sbin/fbset -n 640x480-60
```

```
/usr/sbin/fbset -n 800x600-70
```

It means that the resolution setting is 800*600.

- ❑ If users want to change the setting to be **640*480**, just remove the “#” mark in line 2 and add the “#” mark in line 1. Please see the following setting result :

```
#!/usr/sbin/fbset -n 640x480-60
```

```
#!/usr/sbin/fbset -n 800x600-70
```

STEP4: We are providing the calibration program to test and get the calibration date.(Refer to the Fig. 10-4)

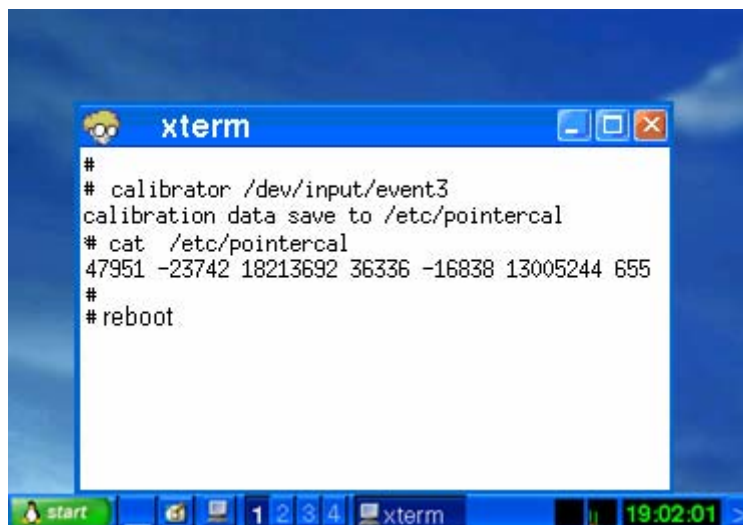

```
xterm
#
# calibrator /dev/input/event3
calibration data save to /etc/pointercal
# cat /etc/pointercal
47951 -23742 18213692 36336 -16838 13005244 655
#
#reboot
```

Fig. 10-4

STEP5: After rebooting the LinPAC-51XX, then the setting will work.

10.5 Network Support

There are many network functions already built in the LinPAC-51XX. Here are the network functions supported in the LinPAC-51XX :

(1) Support UpnP :

UpnP is “**Universal Plug and Play**” and allows automatic discovery and control of services available on the network from other devices without user intervention. Devices that act as servers can advertise their services to clients. Client systems, known as control points, can search for specific services on the network. When they find the devices with the desired services, the control points can retrieve detailed descriptions of the devices and services and interact from that point on.

(2) Support VPN

VPN is “**Virtual Private Network**” and describes a network that includes secure remote access for client computers. It can be explained best by looking at its parts. “**Virtual**” describes the fact that the network doesn’t need to be physically connected directly. The “**Private**” confirms that the data is encrypted and can only be viewed by a defined group. The last word, “**Network**” means that the users configured for VPN can be connected and share files or information. So it’s extremely difficult for anyone to snoop on confidential information through VPN. (Refer to the Fig. 10-5)

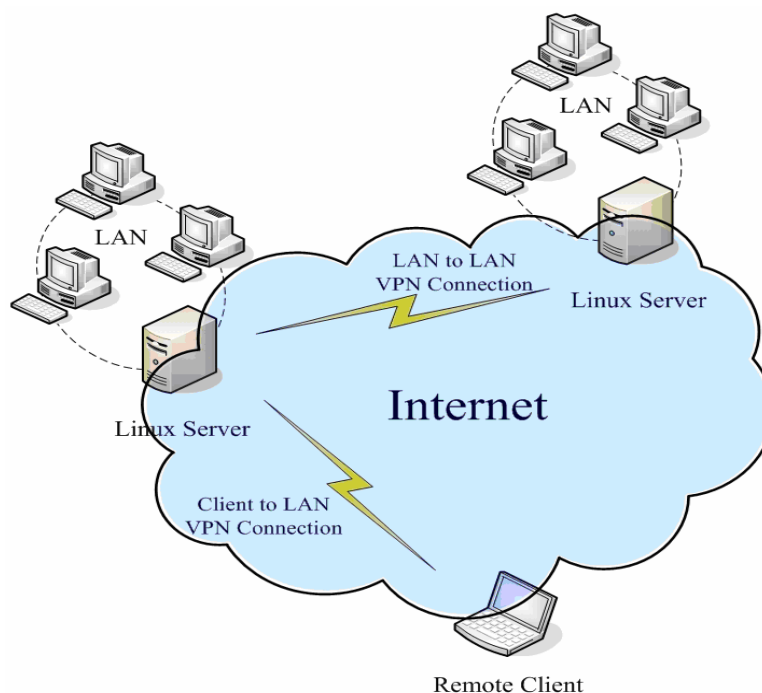

Fig. 10-5

(3) Support QoS

QoS is “**Quality of Service**”. It means when the kernel has several packets to send out over a network device, it has to decide which ones to send first, which ones to delay, and which ones to drop. With Linux QoS subsystem, it is possible to make very flexible traffic control. Let users be able to control flow rate of assigned port to improve the network quality.

(4) Support Wireless LAN

“**Wireless communication**” is a networking technology allowing the connection of computers without any wires and cables, mostly using **radio** technology (and sometime **infrared**). It’s called LAN because the range targeted is small (generally within an office, a building, a store, a small campus, a house...). This technology is slowly growing and Linux is able to take advantage of some of the wireless networks available.

If users plug wireless card in the LinPAC-51XX, users need to modify ***/etc/network/interfaces***.

(5) Support Dual LAN

Dual LAN means that users can combine wireless and cable network together through LinPAC-51XX. Therefore the communication between Cable LAN and Wireless LAN. If one of these LANs can connect to internet, then all the PC can connect to internet. (Refer to Fig. 10-6)

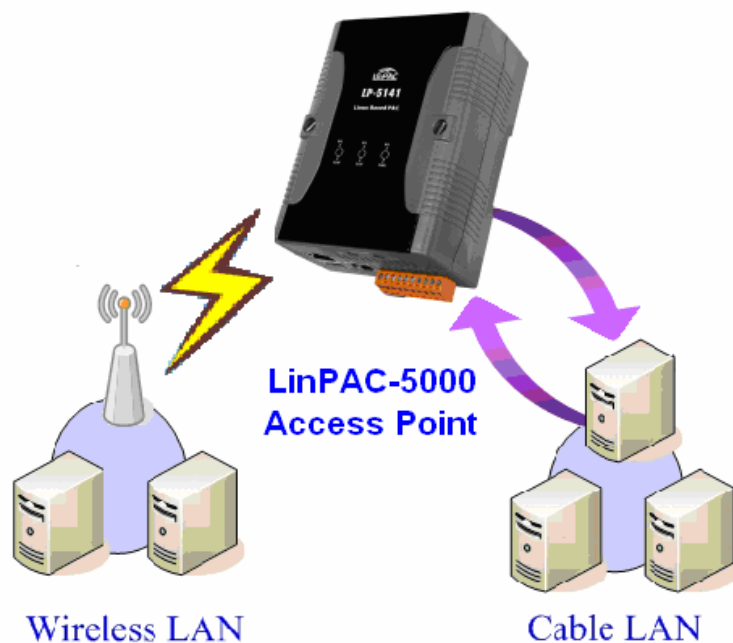

Fig. 10-6

(6) Support BlueTooth

The Bluetooth wireless technology is a worldwide specification for a small-form factor, low-cost radio solution that provides links between mobile computers, mobile phones, other portable handheld devices, and connectivity to the Internet. Now “BlueZ” is built in the LinPAC-51XX and provides support for the core Bluetooth layers and protocols. It is flexible, efficient and uses a modular implementation.

(7) Support Modem / GPRS / ADSL

GPRS modem selection guide:

Module	Install loadable kernel module	Execute command
GTM-201-USB	/lib/modules/2.6.19/sim5218.ko	pppd call 3g &
GTM-201-RS232	/lib/modules/2.6.19/ftdi_sio.ko	pppd call wavecom &

For more information, please refer to: http://m2m.icpdas.com/m2m_layer2_gprs.html

The following describes the operation of the GPRS modem for example: GTM-201-RS232.

□ Part 1

If users want to connect the GPRS modem to the COM3 of LinPAC-8000, users should modify [/etc/ppp/peers/wavecom](#) to define COM port first. Please follow the steps as below to connect the GTM-201-RS232(GPRS Modem) with RS-232 interface:

(1) Type “ **vi /etc/ppp/peers/wavecom** ”

(2) To find the “Serial device to which the GPRS phone is connected:” statement, and add device name of COM port.

(3) Type “ **:wq** ” to save and quit the script. (Refer to the Fig. 10-7)

Note: For support 2G GPRS Modem with, please install loadable kernel module—**ftdi_sio.ko** by **insmod** command.

```
# Serial device to which the GPRS phone is connected:
# /dev/ttyS0 for serial port (COM1 in Windows),
# /dev/ircomm0 for IrDA,
# /dev/ttyUB0 for Bluetooth (Bluez with rfcmm running) and
# /dev/ttyUSB0 for USB
#/dev/ttyS34 # serial port one
#/dev/ttyS0 # serial port one
/dev/ttyS1 # serial port two → Connect the gprs to the COM3
#/dev/ircomm0 # IrDA serial port one
#/dev/rfcomm0 # Bluetooth serial port one
#/dev/ttyUSB0 # USB serial device, for example Orange SPV
```

Fig. 10-7

❑ Part 2

According to the GPRS chip default baud rate is “115200” bps, GPRS module and device node such as /dev/ttyS2, both of them should have same baudrate. User can use ‘stty’ command to set the input and output speed of the device node.

```
# login 1
linpac-8000 login: root
Password:
MOKI 0.90
Jan  3 18:01:25 login[1240]: root login on 'console'
-sh: can't access tty; job control turned off
installed modules list
slot 1 ... 8112
# insmod /lib/modules/2.6.19/ftdi_sio.ko 2
drivers/usb/serial/usb-serial.c: USB Serial support registered for FTDI USB
Serial Device
usbcore: registered new interface driver ftdi_sio
drivers/usb/serial/ftdi_sio.c: v1.4.3:USB FTDI Serial Converters Driver
# stty -F /dev/ttyS2 ispeed 115200 ospeed 115200 3
# stty -F /dev/ttyS2
speed 115200 baud;
intr = ^C; quit = ^\; erase = ^?; kill = ^U; eof = ^D; eol = <undef>;
eol2 = <undef>; start = ^Q; stop = ^S; susp = ^Z; rprnt = ^R; werase = ^W;
lnext = ^V; flush = ^O; min = 1; time = 0;
-brkint -imaxbel
```

Fig. 10-8

Before startup GPRS, you have to take down the network interface of eth0 and eth1, remove the net cable, and type in “ifdown eth0” or “ifdown eth1” to stop it.

Type in “pppd call wavecom &” and then LinPAC-51XX will be connected to the internet automatically. Remember that the network interface of LinPAC should stop first. If users type in “ifconfig” will see the “ppp0” section.

```
# ifconfig
eth0  Link encap:Ethernet HWaddr 00:90:E0:AB:CD:12
UP BROADCAST RUNNING MULTICAST  MTU:1500 Metric:1
RX packets:0 errors:0 dropped:0 overruns:0
TX packets:3 errors:0 dropped:0 overruns:0
collisions:0 txqueuelen:1000
RX bytes:0 (0.0 B) TX bytes:1770 (1.7 KiB)
Interrupt:41 Base address:0x8000

eth1  Link encap:Ethernet HWaddr 00:90:E0:AB:CD:13
UP BROADCAST RUNNING MULTICAST  MTU:1500 Metric:1
RX packets:0 errors:0 dropped:0 overruns:0
TX packets:3 errors:0 dropped:0 overruns:0
collisions:0 txqueuelen:1000
RX bytes:0 (0.0 B) TX bytes:1770 (1.7 KiB)
Interrupt:114 Base address:0xc000

lo    Link encap:Local Loopback
inet addr:127.0.0.1 Mask:255.0.0.0
UP LOOPBACK RUNNING  MTU:16384 Metric:1
RX packets:0 errors:0 dropped:0 overruns:0 frame:0
TX packets:0 errors:0 dropped:0 overruns:0
collisions:0 txqueuelen:0
RX bytes:0 (0.0 B) TX bytes:0 (0.0 B)

ppp0  Link encap:Point-to-Point Protocol
inet addr:111.81.57.21 P-t-P:10.64.64.64 Mask:255.255.255.255
UP POINTOPOINT RUNNING NOARP MULTICAST MTU:1500 Metric:1
RX packets:8 errors:0 dropped:0 overruns:0 frame:0
TX packets:7 errors:0 dropped:0 overruns:0 carrier:0
collisions:0 txqueuelen:3
RX bytes:186 (186.0 B) TX bytes:129 (129.0 B)
```

Fig. 10-9

See the routing table below and let's try connecting:

```
# route 1
Kernel IP routing table
Destination Gateway Genmask Flags Metric Ref Use Iface
192.200.1.21 * 255.255.255.255 UH 0 0 0 ppp0
default 192.200.1.21 0.0.0.0 UG 0 0 0 ppp0
#
# ftp ftp.speed.hinet.net 2
Connected to ftp.speed.hinet.net.
220- Welcome to HiNet SpeedTest FTP site.
220- (ftp.speed.hinet.net)
220
Name (ftp.speed.hinet.net:root): ftp
331 Please specify the password.
Password:
230 Login successful.
Remote system type is UNIX.
Using binary mode to transfer files.
ftp> by
221 Goodbye.
#
```

Fig. 10-10

[ADSL]

Users need to type in “**adsl-setup**” first to setup ADSL options. After that, users need to type in “**adsl-connect**” to make LinPAC-51XX connect to the internet. If users want to stop adsl connection, just type in “**adsl-stop**”.

(8) Support Firewall (iptables function)

A firewall can controls outside access to a local network, locking out intruders to ensure your systems and data safe on the inside, even against an intentional attack from outside network.

(9) Provide Web Browser

Users can see the Web Page by using the Web Browser built in the LinPAC-51XX. Just type in “**dillo**” to open the web browser and input the web site address. (Refer to Fig 10-11) (Note : dillo is placed in the path : /mnt/hda/opt/bin so users need to plug microSD Card in the LinPAC first, and .)



Fig 10-11

(10) Provide Apache Server

The Web Server – “**Apache Server**” has been built in the LinPAC-51XX and it will be started automatically when boot up. These files are placed in the path – **/opt/apache2**. Users can type like “<http://192.168.0.200>” to connect to the web server in the LinPAC-51XX. If it returns a successful web page, it means that the web server in the LinPAC-51XX has been started. The index web page of Apache Server is in the path : “**/opt/apache2/htdocs/**” .

These files placed in the microSD card are full functions of Apache Server. So if users want to use other function of Apache Server that are not supported in the LinPAC-51XX, users just copy them to the path : **/opt/apache2** and reboot.

10.6 Audio Function

LinPAC-51XX support audio function— MAD(MP3 Audio Recorder, MAD), the MP3 Audio Recorder is a powerful sound recording and playing program. With it user can record sound from microphone and play sound form speaker. Recorded sound can be saved in Wav-file, MP3, WMA format, etc. There are three major types of audio functions:

❑ Volume adjustment

The **smixer** is a command-line and scriptable program to control and display the mixer volume levels on a sound card in LinPAC-51XX. If users want to adjust the MIC/Speaker volume, Please follow the steps:

(1) Type “**vi /etc/smixer.conf**” to adjust volume of Mic, lgain, Spkr, Rec, etc.

(2) Type “**smixer -a /etc/smixer.conf**” to set settings from file.

If users want to know the detailed parameters of madplay, just type in “**smixer help**” or refer to <http://centerclick.org/programs/smixer/man.html>.

❑ Sound player

In LinPAC-51XX, the **madplay** is a command-line MPEG audio decoder and player. After users download music files into LinPAC-51XX, please refer to the following ways for play:

(1) Type “**madplay test.mp3 -q**” to normal.

(2) Type “**madplay test.mp3 -q -a +10**” to increase 10 decibels.

(3) Type “**madplay test.mp3 -q -a -10**” to decrease 10 decibels.

If users want to know the detailed parameters of madplay, just type in “**madplay -help**”

❑ Sound recorder

Please follow the steps to make the sound recoder function work smoothly:

(1) Type “**cat /dev/dsp > /dev/dsp**” to listen to the speaker from microphone.

(2) Type “**cat /dev/dsp > /var/test.wav**” to save file from microphone recorder.

(3) Type “**cat /var/test.wav > /dev/dsp**” to listen to the test.wav from speaker.

Note: This function can not support LP-5131 and LP-5141.

10.7 USB to RS-232 Support

LinPAC-51XX support USB to RS-232 converter— I-7560 for example. The I-7560 contains a Windows serial com port via it's USB connection and is compatible with new and legacy RS-232 devices. USB Plug-and-Play allows easy serial port expansion and requires no IRQ, DMA, or I/O port resources. (http://www.icpdas.com/products/Remote_IO/i-7000/i-7560.htm)

Please follow the steps to make the USB to RS-232 converter work smoothly :

- (1) Connect the I-7560 to the LinPAC-51XX with “**USB Interface**”.
- (2) Power on.
- (3) Open a “**Command Prompt**”. Type in “**insmod pl2303.ko**” to load the program decompressor.
- (4) Upon successfully insmodding, a new **/dev/ttyUSB0** serial device is created, user can use “**echo**” and “**cat**” command to send and receive message as below.



```
10.1.0.38 [44x21]
# echo 7560_com3>/dev/ttyUSB0
# echo 7560_com3>/dev/ttyUSB0
# echo 7560_com3>/dev/ttyUSB0
# echo 7560_com3>/dev/ttyUSB0
#
# echo 7560_com2>/dev/ttyUSB0
# echo 7560_com2>/dev/ttyUSB0
# echo 7560_com2>/dev/ttyUSB0
# echo 7560_com2>/dev/ttyUSB0
#

10.1.0.38 [47x21]
7560_com3
7560_com3
7560_com3
7560_com3
7560_com2
7560_com2
7560_com2
7560_com2
7560_com2
```

10.8 Other Optional Function

These optional functions are listed below all supported in the LinPAC-51XX. Users can choose which function to be used in the LinPAC-51XX and just copy the corresponding file directory to the “**opt**” directory of microSD card. Then reboot LinPAC-51XX and the function users choose will work automatically.

(1) Support MySQL

MySQL is a small database server and it is “Relational DataBase Management System (RDBMS)”. By using MySQL, users can add or delete data easily and it is open source and supports many platforms, like UNIX、Linux or Windows operating system. If users want to use MySQL in the LinPAC-51XX, check the “**mysql**” directory in the /opt directory of microSD card, and user can choose one of the following:

a) Manual	b) Auto
<pre># mysql_install_db # mysqld_safe --user=root & # mysql</pre>	<pre># cd /etc/rc2.d # ln -s ../init.d/mysql.server S88mysql # cd /etc/rc0.d # ln -s ../init.d/mysql.server K15mysql # cd /etc/rc6.d # ln -s ../init.d/mysql.server K15mysql # reboot # mysql</pre>

```
# mysql
Welcome to the MySQL monitor.  Commands end with ; or \g.
Your MySQL connection id is 1 to server version: 4.1.10

Type 'help;' or '\h' for help. Type '\c' to clear the buffer.

mysql>
mysql>
```

Fig 10-12

Please refer to the following steps to compile a mysql demo program by SDK toolchain:

- 1) Download mysql directory from /opt directory of microSD card to C:\cygwin\opt\
- 2) Coding a demo program in C:\cygwin\LinCon8k\examples
- 3) Double click the "[LinPAC-51XX Build Environment](#)" to compile applications.
- 4) To compile:

```
C:\cygwin\LinCon8k\examples> arm-linux-gcc -I..\..\opt\mysql\include\mysql\
-L..\..\opt\mysql\lib\mysql\ insert_test.c -o insert_test.exe -lmysqlclient
```

(2) Support PHP

PHP is a kind of “open source script language” and used to design active web page. When PHP combined with MySQL are cross-platform. It means that users can develop in Windows and serve on a Linux platform. (Refer to Fig 10-13)

PHP has been built in the LinPAC-51XX kernel so users just boot up LinPAC-51XX and can use PHP directly in the LinPAC-51XX.

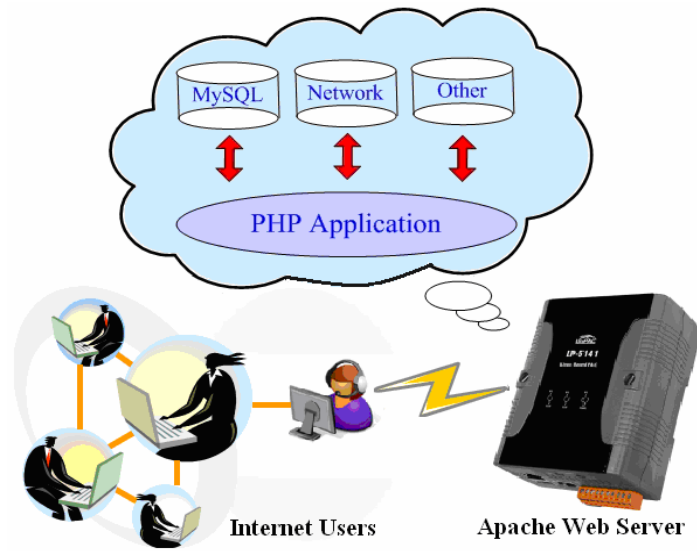

Fig 10-13

(3) Support Perl

Perl (Practical Extraction and Report Language) is also a “open source script language“ and has been built in the LinPAC-51XX kernel so users just boot up LinPAC-51XX and can use Perl directly in the LinPAC-51XX.

Appendix A. Service Information

This appendix will show how to contact ICP DAS when you have problems in the LinPAC-51XX or other products.

Internet Service :

The [internet service](#) provided by ICP DAS will be satisfied and it includes [Technical Support](#), [Driver Update](#), [OS_Image](#), [LP-5000 SDK](#) and [User's Manual Download](#) etc. Users can refer to the following web site to get more information:

1. **ICP DAS Web Site:** <http://www.icpdas.com.tw/>
2. **Software Download:** <http://www.icpdas.com/download/index.htm>
3. **Java Supported Document :** <http://www.icpdas.com/download/java/index.htm>
4. **E-mail for Technical Support:** service@icpdas.com or service.icpdas@gmail.com

Manual Revision :

Manual Edition	Revision Date	Revision Details
v1.0	2010. 11	1. Modify the LP-5000 SDK installation path 2. Add demo description in chapter 7
V1.1	2010. 12	1. Add mysql description 2. Add microSD card instruction 3. Add 4.2.3 scan and repair microSD card 4. Add e-mail account (gmail) 5. Add quick installation guide for Linux 6. Add USB to serial support
V1.2	2011. 12	1. Add SDK guide in Linux PC 2. Add detailed description for GPRS usage
V1.3	2012. 02	1. Update 8250_linpac.ko and modify the COM port definition in chapter 8
V1.4	2012. 06	1. Rename the product name and change the FTP download site. 2. Add Touch screen support