PROFI-8155/PROFI-8255

User Manual



Warranty

All products manufactured by ICP DAS are warranted against defective materials for a period of one year from the date of delivery to the original purchaser.

Warning

ICP DAS assumes no liability for damages consequent to the use of this product. ICP DAS reserves the right to change this manual at any time without notice. The information furnished by ICP DAS is believed to be accurate and reliable. However, no responsibility is assumed by ICP DAS for its use, or for any infringements of patents or other rights of third parties resulting from its use.

Copyright

Copyright 2008 by ICP DAS Co., LTD. All rights reserved worldwide.

Trademark

The names used for identification only may be registered trademarks of their respective companies.

List of Revision

Date	Author	Version	Revision
2008/10	Jeff Ma	1.0	Release

Table of Content

1.	Introduction	4
1.1.	Overview	4
1.2.	Applications	4
1.3.	Features	5
1.4.	Specifications	6
1.5.	Modules Support	7
2.	Hardware	8
2.1.	PROFI-8155/8255 Hardware Structure	8
2.2.	Bus Wiring	9
2.3.	PROFIBUS Cable and Transmission Distance	10
2.4.	Status Indicator	11
2.5.	Connector	13
2.6.	Watchdog mechanism	14
2.7.	Node Address	15
2.8.	Baud rate support	17
3.	PROFIBUS DP System	18
3.1.	The flow chart of the DP-slave	18
3.2.	Power On / Reset – Rotary switch	19
3.3.	Parameterization Data	20
	System parameters	20
	Module parameters for I-8K module	20
	Module Parameter for i-87K module:	21
	Module Parameter for Output modules:	24
3.4.	Wait Configuration	26
	Configuration Data	26
3.5.	Data Exchange	30
	Numeric Representation	30
	Byte Order and Data Address	43
3.6.	Diagnostic Message Report	53
3.7.	DP-V1 Acyclic Service	56
3.8.	Establish connection with PROFI-8X55	61
3.9.	Telegram cycle of data exchange	62
4.	PROFI-8X55 Guideline (Based on Step 7)	64
4.1.	Preprocessing	64
5.	GSD File	68

1. Introduction

1.1. Overview

PROFIBUS is an open, digital communication system with a wide range of applications, particularly in the fields of factory automation and process automation. PROFIBUS is suitable for both fast, time-critical applications and complex communication tasks. PROFIBUS-DP is a famous protocol that enables simple, fast, cyclic and deterministic process data exchange between Master and assigned Slave.

The PROFI-8155/8255 Remote I/O Unit is specially designed for the slave device of PROFIBUS DP protocol. It supports up to 1/2 I/O slots for ICP DAS i-8k series, i-87k Low Profile series and i-87k High Profiles series I/O modules. In addition, we also provide the hot-swap function for i-87k High Profiles series I/O modules. To setup PROFIBUS network, users can choose and configure I/O modules by using the GSD file without any other setting tools.

1.2. Applications

- Industrial Automation
- Factory Automation
- Process Automation
- Etc...

1.3. Features

Protocol & Hierarchy	DP-V0 & DP-V1 Slave
Supports Transmission Rate (Kbps)	9.6, 19.2, 45.45, 93.75, 187.5, 500, 1500, 3000, 6000, 12000
Transmission Rate Setting	detected automatically
Address Setting	0~126 set by Rotary Switches SSA-telegram set by DP-Master(Class 2)
Indicators	PWR, ERR, and RUN LEDs
I/O modules Configuration	Configured by GSD file
Supports I/O modules hot-swap	I-87K High Profile series
Network Isolation Protection	High Speed iCoupler
DC Isolation Protection	3000VDC on PROFIBUS side
4KV ESD Protection	Contact for each terminal
Number of Channel of Diag.	32
Device-Related Diag. Type	Offline Detection

1.4. Specifications

Model	PROFI-8155	PROFI-8255
CPU	80186, 80MHz	
Flash	512K Bytes	
SRAM	512K Bytes	
EEPROM	2K Bytes	
Watch Dog Timer	CPU Built-in	
Com1	RS-232(F/W update port at JP1)	
PROFIBUS Interface	9-pin D-Sub(Female)	
PROFIBUS Controller	Siemens SPC3	
PROFIBUS Transceiver	ADI ADM2486 iCoupler Isolated Transceiver	
Transmission Rate	Up to 12Mbps	
I/O Expansion Slot	1 Slots	2 Slots
Power Requirement	10V ~ 30V	
Power Supply	8W	
Power Consumption	3W	
Operating Temperature	-25°C ~ +75°C	
Storage Temperature	-30°C ~ +85°C	
Humidity	5% ~ 95% No-Condensing	
Dimensions	65x115x90 mm	95x115x90 mm

1.5. Modules Support

Type	Module Name	Type	Module Name
DI	i-8040 / i-8051 / i-8052 / i-8053 / i-8058 i-87040 / i-87051 / i-87052 / i-87053 / i-87058 i-87040W / i-87046W / i-87051W / i-87052W / i-87053W / i-87053W-A5 / i-87058W / i-87059W	AI	i-8017H / i-8017HS i-87013 / i-87017 / i-87018 i-87013W / i-87015 /i-87015P/ i-87017W / i-87017W-A5 / i-87017R / i-87017RC / i-87018R / i-87018Z / i-87019R
DO	i-8037 / i-8041 / i-8056 / i-8057 / i-8060 / i-8064 / i-8065 / i-8066 / i-8068 / i-8069 i-87041 / i-87057 / i-87064 / i-87065 / i-87066 / i-87068 / i-87069 i-87041W / i-87057W / i-87064W / i-87065W / i-87066W / i-87068W / i-87069W	AO	i-8024 i-87022 / i-87024 / i-87026 i-87024W
DI/O	i-8042 / i-8050 / i-8054 / i-8055 / i-8063 / i-8077 i-87054 / i-87055 / i-87063 i-87054W / i-87055W / i-87063W	Counter / Frequency	i-8080 i-87082 i-87082W

2. Hardware

2.1. PROFI-8155/8255 Hardware Structure

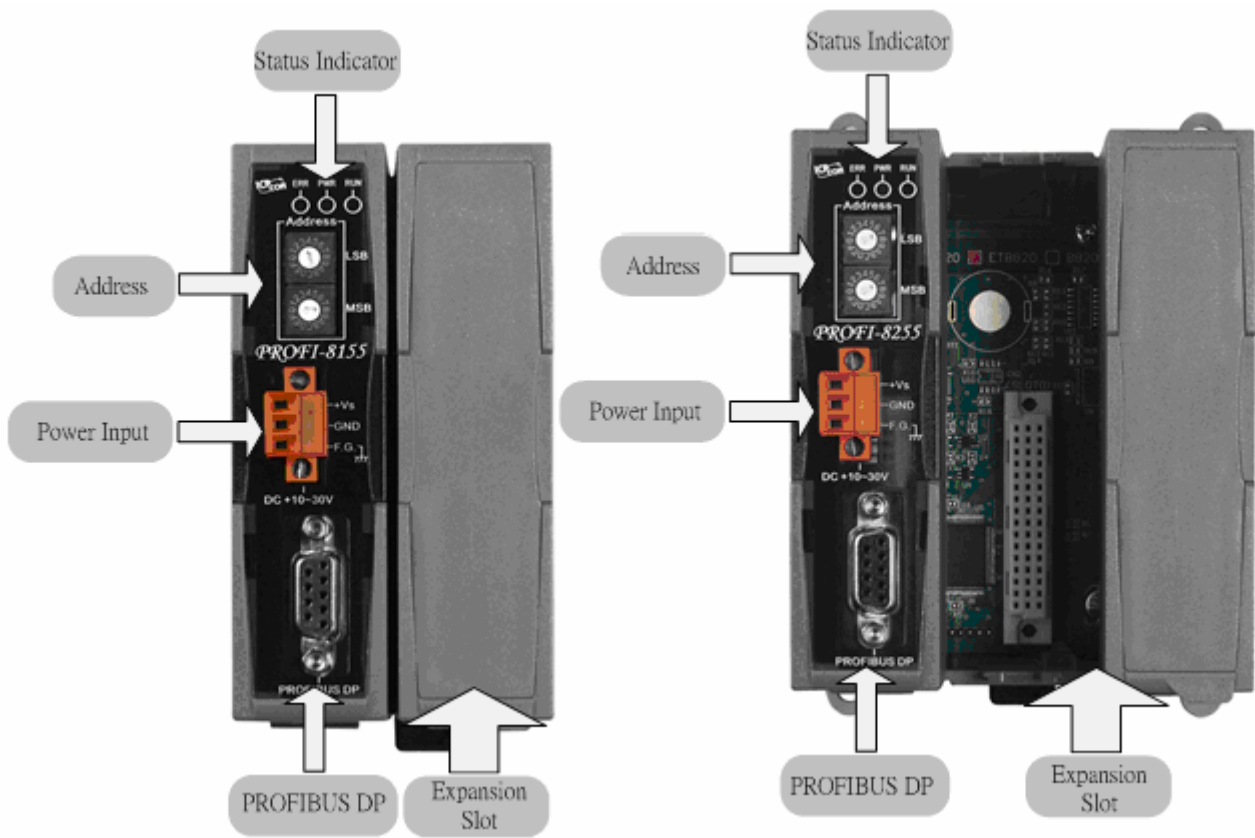

2.2. Bus Wiring

In order to minimize the reflection effect of the signal transmission, PROFIBUS device has to fit with an active terminal resistor at both first node and last node, as shown below

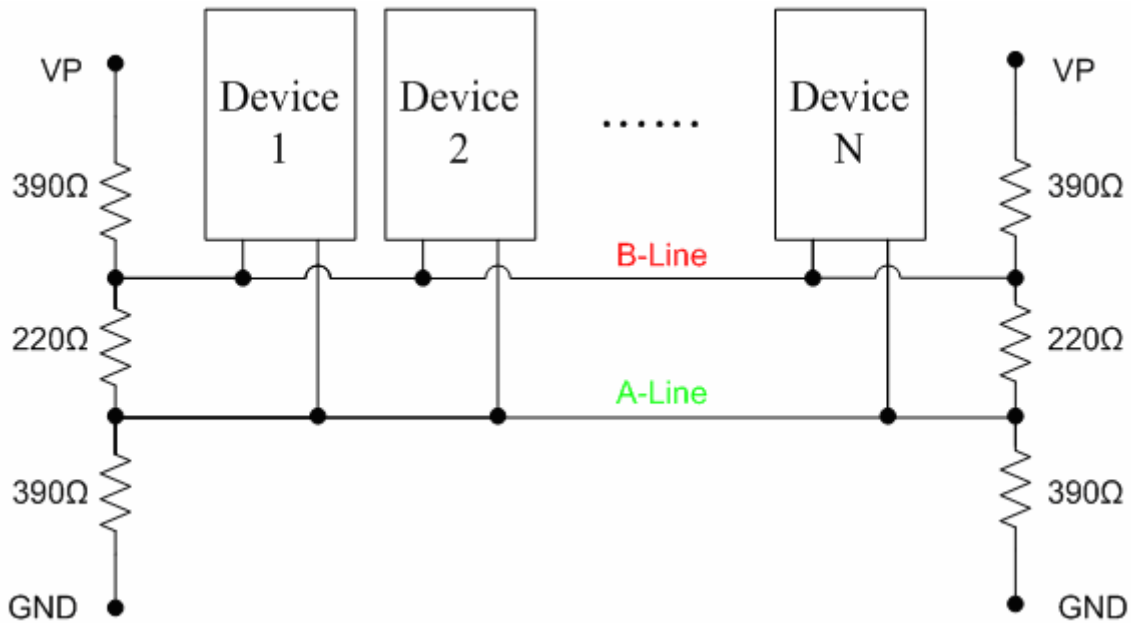

However, the number of station in PROFIBUS network is also restricted. According to PROFIBUS specification, it is up to 32 stations connected in a PROFIBUS segment. If more than 32 stations are connected, the PROFIBUS repeater must be used to link the individual bus segments.

2.3. PROFIBUS Cable and Transmission Distance

The PROFIBUS cable with following properties has different transmission distance with respect to different transmission rate, shown in the following table

1. Impedance : 135~165Ω
2. Capacity : lower than 30 pF/m
3. Loop resistance : lower than 110Ω/Km
4. Wire diameter : larger than 0.65mm
5. Core cross-section : larger than 0.34mm²

Transmission Rate(Kbps)	Transmission Distance per Segment (meter)
9.6, 19.2, 45.45, 93.75	1200
187.5	1000
500	400
1500	200
3000, 6000, 12000	100

2.4. Status Indicator

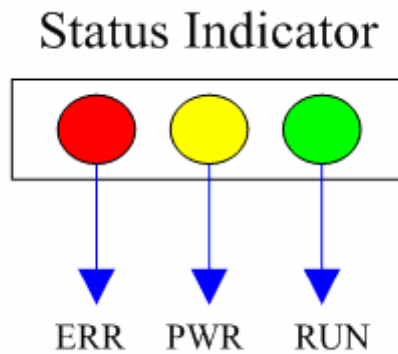

PROFI-8x55 provide three types of status indicators, they are PWR LED (yellow), ERR LED (red) and RUN LED (green). When the power is supplied to PROFI-8x55, PWR LED will turn on; Before PROFI-8x55 gets into the data exchange state, ERR LED will turn on or flash; If CHK_CFG procedure is finished, RUN LED will turn on and ERR LED will turn off. The table below explains the relationship between linking status and recommend solutions.

Status Indicator	Meaning	Recommend solution
ERR ON & RUN OFF	PROFI-8x55 is offline with no valid baud rate (offline mode*)	Check the address setting of PROFI-8x55 and DP-master.
ERR Flash (10Hz)	PROFI-8x55 detects baud rate, but is still offline.(stop mode*)	Check the DP-Master is ready to communicate with PROFI-8x55.
ERR Flash (2Hz)	PROFI-8x55 Prm is Fault.(Note 1)	Check the setting of PROFI-8x55 in the master interface and make sure of the consistency.
ERR Flash (1Hz)	PROFI-8x55's Cfg is fault(Note 2)	Same as above
ERR ON & RUN ON	PROFI-8x55 is in clear mode*.	Sets the DP-Master from clear mode to operation mode
ERR OFF & RUN ON	PROFI-8x55 is in operation mode*.	
PWR & ERR Flash together(1Hz)	PROFI-8x55 detect module(s) offline	Find the reason of the fault of corresponding module.
PWR & ERR Flash Interlace(2Hz)	Diag Exist (Diag. Msg. Request)	Check the Input/Output value that if exceed/under the limit

Note 1: “Prm Fault” is the abbreviation of “Parameter Fault”; It means that the number of parameter data which receive from DP-Master is not consistency with DP-Slave (PROFI-8x55), and it could due to the difference between module installation and master setting.

Note 2:“Cfg Fault” is the abbreviation of “Configuration Fault”, it means that the number of configuration data which receive from DP-Master is not consistency with DP-Slave (PROFI-8x55), and it could due to the wrong order of installation.

Note *: there are four kinds of state in PROFIBUS DP Master.

1. Offline mode: Master not active on the bus.
2. Stop mode: Master only transmit token on the bus, and PROFIBUS DP is not active.
3. Clear mode: DP Master active, but all output are zero or set to fail-safe state.
4. Operate mode: DP Master full active.

Note: Diag. Exist mean that PROFI-8x55 detected the I/O value (analog signal) of the module exceed or under the limitation of corresponding module, or detected the line-broken of the temperature-sensor that should connect to the module.

2.5. Connector

The connector of PROFI-8x55 is shown below

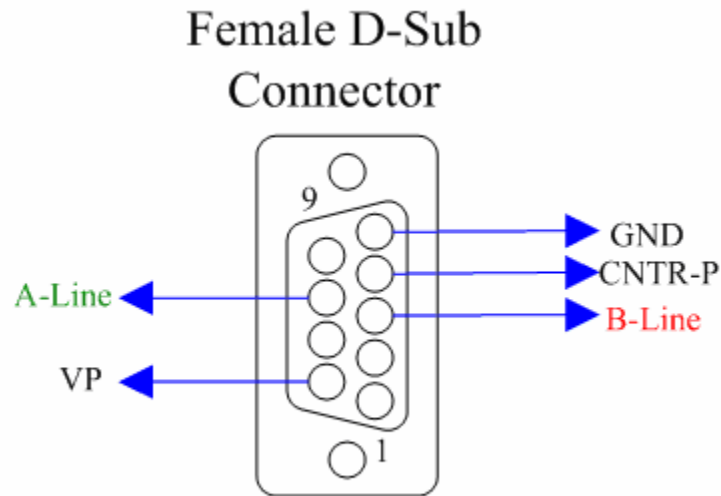

Pin No.	Signal	Meaning
3	B-Line	Receive/Transmit data - plus
4	CNTR-P	Repeater control signal, RTS signal
5	GND	Power ground of bias terminator
6	VP	Power 5 volt of bias terminator
8	A-Line	Receive/Transmit data - minus

Note: The connector of PROFI-8x55 has no terminators; users must use the cable connector that contain bias-terminator inside. The power of the bias-terminator provide by PROFI-8x55 or other end-device.

2.6. Watchdog mechanism

PROFI-8x55 has a built-in watchdog timer to monitor the linking status with Master. In order to ensure an error-free connection, watchdog mechanism divides into three stages.

In the first stage, watchdog detects the start delimiter whether valid or not after the status of power supplied or system reset. If no SD1 telegram, SD2 telegram, or SD3 telegram are received completely, PROFI-8x55 will change the baud rate and continues detecting the correct baud rate. This stage is called “Baud Search”.

If the watchdog has detected a valid SD telegram, it goes into the second stage. In this stage, the watchdog monitors the integrity of the telegram. When watchdog timer is expired and PROFI-8x55 doesn't receive the complete telegram, PROFI-8x55 will go to “Baud Search” state. This stage is called “Baud Control”.

After PROFI-8x55 finished initializing, PROFI-8x55 waits for receiving the Set_Prm telegram. If PROFI-8x55 receives the Set_Prm telegram with “WD_On=1”, then watchdog goes into DP_Control and monitors the telegram in Twd time. Otherwise, watchdog retains in the “Baud Control” state. This stage is called “DP_Control”.

Besides the watchdog mechanism mentioned above, i-87K modules with analog output or digital output have their own host watchdog to monitor the status of PROFI-8x55. If PROFI-8x55 lost the control of DP-Master (due to any unpredictable fault), it can't send a specific watchdog command to flush the watchdog timer of i-87K modules. Then the module will switch to safe mode, and wait for resetting. There are three kinds of safe-value at safe-mode, they are “retain last valid value”, “clear output”, and “switch to substitute value”. Although i-8K support this safe-mechanism, but it has no ability to process the fail safe value output by itself in case of MCU broken.

2.7. Node Address

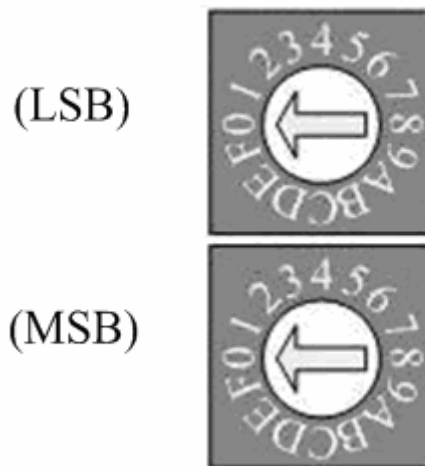

The figure shown above is the hexadecimal rotary switches. It dominates the node (station) address of PROFI-8x55 in PROFIBUS. The switch which labeled MSB is high nibble of address and the other one is low nibble of address.

According to PROFIBUS specification, the station address which from 0 to 126 is valid, and the address 126 is a special address that supports remote setting by SSA telegram from Class 2 DP-Master. PROFI-8x55 applies the setting of rotary switch as its address if the address is valid. While the address is invalid, PROFI-8x55 loads the pre-saved value from EEPROM. Moreover, if the address is invalid (126) again, PROFI-8x55 awaits the SSA telegram and applies it. (Note: If you want to clear the setting stored at EEPROM, you just adjust rotary switch to FF before the power supplied).

Rotary Switch(dec)	Pre-saved address (EEPROM)	SSA Telegram	PROFI-8x55 Station Address
0~125	Don't care	No Accept	Rotary Switch
126~254	0~125	No Accept	Pre-saved address (EEPROM)
	126 (default)	Accept with address 0~125	SSA Telegram and save address to EEPROM
	127~254	impossible	N/A
255	Clear to 126	Accept with address 0~125	SSA Telegram and save address to EEPROM

Note 1: Only one DP-Slave station with address 126 permitted in the bus.

Note 2: if you want to change the station address after data exchange, PROFI-8455 should return to Wait-Prm state and wait for one second to apply the new address.

2.8. Baud rate support

PROFI-8x55 supports the entire baud rates of PROFIBUS. They are 9.6Kbps, 19.2Kbps, 45.45Kbps, 187.5Kbps, 500Kbps, 1.5Mbps, 3Mbps, 6Mbps, and 12Mbps. Because PROFI-8X55 has a functionality of auto-baud rate detection, users needn't to set the baud rate of PROFI-8x55.

Note: Many baud rates only are supported by the particular cable or speed. For the details, please refer to the above section “**PROFIBUS Cable and Transmission Distance**”

3. PROFIBUS DP System

3.1. The flow chart of the DP-slave

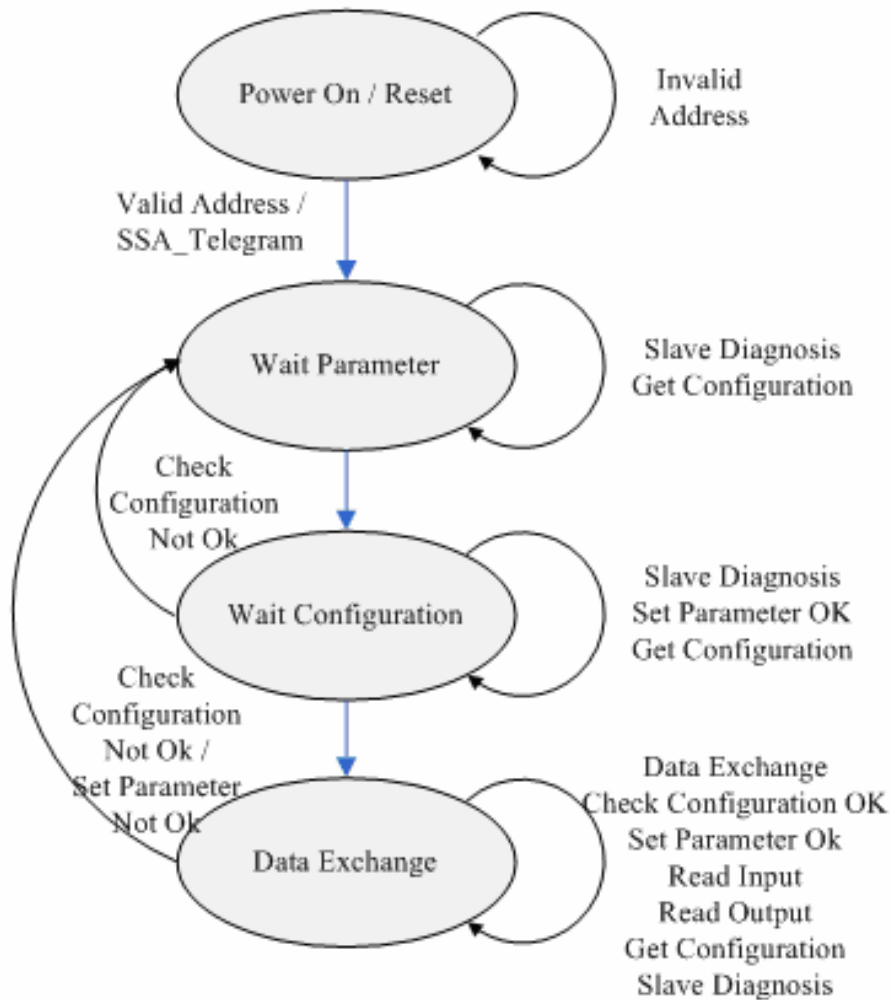

Before DP-Slave switch to data exchange state, it employs some telegrams to initialize and establish the connection with DP-Master. These telegrams include Slave Diagnosis (Slave_Diag), Set Parameter (Set_Prm), Check Configuration (Chk_Cfg), Slave Diagnosis, Data Exchange (Data_Exch) and optional global control (GC). The explanation is as follows:

3.2. Power On / Reset – Rotary switch

While the power of PROFI-8x55 supplied, PROFI-8x55 loads the value of rotary switch first and decides to apply it or not by according to mechanism as follows. If the address of rotary switch is smaller than 126, PROFI-8x55 applies the value directly. PROFI-8x55 loads the pre-saved address from EEPROM, if the address of rotary switch is larger than 126 but smaller than 255. If the address stored at EEPROM is equal to 126 again, PROFI-8x55 will wait for the Set_Slave_Add(SSA) telegram. A special address 255 is used for recovering address 126 to EEPROM in case of error SSA_telegram setting or other cases. For details, please refer to the next chapter. The figure below shows the state flow of Wait SSA.

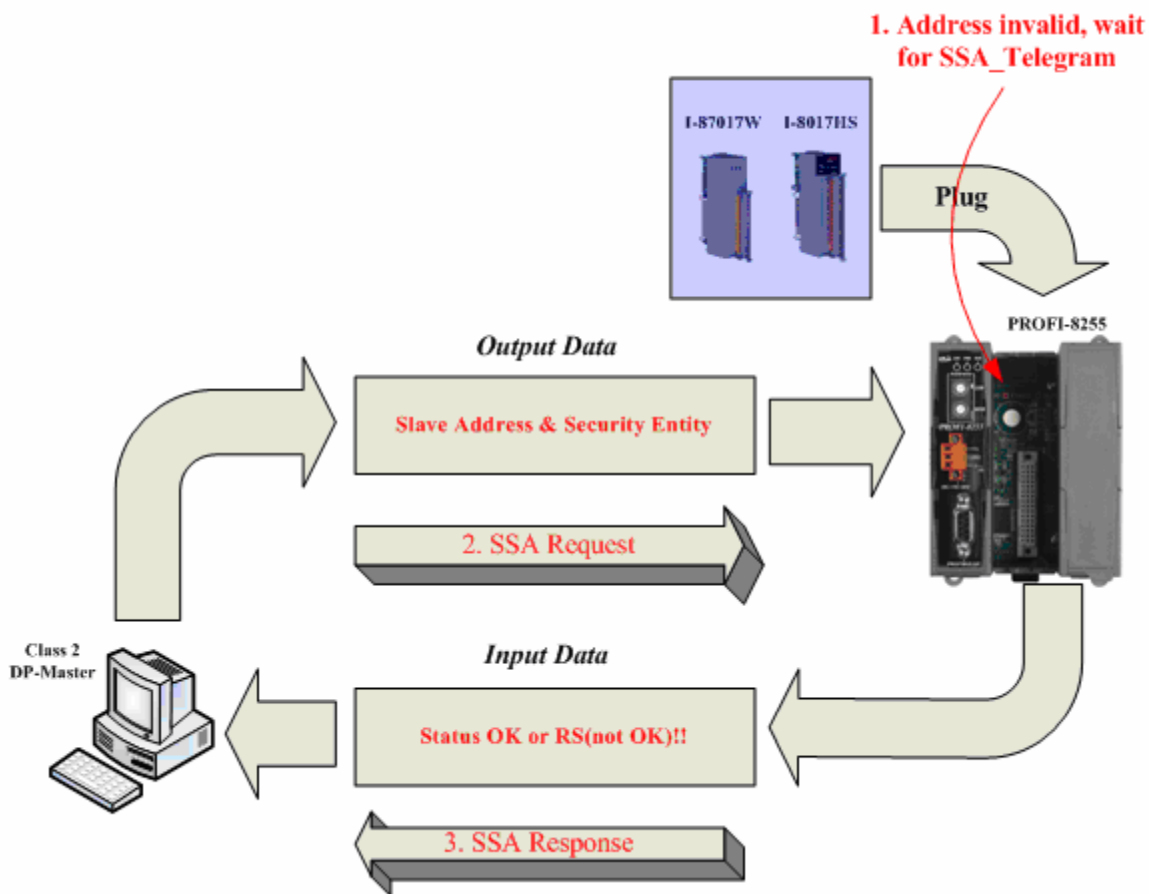

3.3. Parameterization Data

In order to establish the connection completely, the DP-Slave should obtain enough information from the DP-Master. The DP-Slave applies the parameterization data to the I/O module of DP-Slave. DP-master divided these parameters into two parts: one is master-related parameter, and another one is module-related parameter. Master-related parameters provide the common setting between DP-Master and DP-Slave (e.g. Byte-Order). Module-related parameters provide the fundamental setting of the I/O modules in DP-Slave. If the parameters have been applied successfully, DP-state will switch to wait configuration, otherwise return to wait parameter.

PROFI-8x55 has two kinds of parameter data. First kind of parameters is the system data, and another one is I/O module data. In i-8K modules, there is no I/O module parameter except for i-8017H(S), i-8024, i-8050 and i-8080. In i-87K modules, every module has their own parameters to determine the data format and operation mode. We will describe the I/O modules individually in next section.

System parameters

1. Byte-Order

The memory allocation is according to the slot identifier. Therefore, the I/O module at slot 0 will allocate first, slot 1 in next and so on. Byte order is an important factor related to the memory allocation. Big-endian byte order (Motorola format) allocates more significant byte in lower memory address. On the other hand, little-endian Byte order (Intel format) allocates more significant byte in higher memory address.

For example, the integer which value is 0x0400(hex) will allocates 0x40(hex) in the first byte of the memory allocated to the integer and 0x00(hex) in the second byte.

Module parameters for I-8K module

i-8017H(S)

i-8017 is a standard analog input module; it requires the parameter of “Data Format”, “Data Range” and “Diag Enable” to establish the connection completely. In order to reduce the length of parameter data, PROFI-8x55 encapsulates this information into one byte per channel. So there are 8 bytes data for i-8017H and 16 bytes for i-8017HS.

Data range mean the measurement type (voltage, current) and range

(-10v to 10v or 4mA to 20mA). Data format can be selected either engineer unit format or hexadecimal format. “Diag Enable” is a flag that determines PROFI-8455 whether diagnostic message will report or not.

i-8024:

i-8024 is similar to i-8017H(S) , please refer to i-8017H(S) .

i-8050:

i-8050 is a programmable digital input/output module with 16 programmable I/O. It is different from the other digital modules. Before using i-8050, MCU must configure it first. PROFI-8x55 provides a 2-byte parameter to configure i-8050. The first byte controls the direction (Input or Output) of channel 15 to channel 8, and the second byte correspond to channel 7 to channel 0. As mentioned above, digit ‘1’ represents input and ‘0’ represents output.

i-8080:

i-8080 is a counter/frequency module with 30 bytes parameter. PROFI-8x55 divides these parameters into 2 parts; First part is only for frequency mode, which are updated period of auto mode, low-frequency mode, and high frequency respectively. Another part is for both Frequency and Counter mode, which are XOR-Register, Channel Mode, Frequency Band, Filter Enabled, and Low Pass Filter Pulse Width respectively. Note that if frequency band selected inappropriately, it will induce to incorrect measurement. For example, if an input signal is 80 KHz and frequency band is set to low frequency band with 1000ms update period, then it will measure 65.536 KHz instead of 80 KHz. Therefore selecting an appropriate frequency band is necessary. For the detail, please refer to i-8080 user manual. In additional, PROFI-8x55 provides another parameter that chooses the trigger type of count clear. User can choose one of them if needed.

Note: i-8080 hardware counter is 16 bit and maximum counter value is 65535. PROFI-8x55 uses the software method to expand this bound to 2^{48} , so user should pay attention to some limitations.

Module Parameter for i-87K module:

Before using i-87K module with PROFI-8x55, it must be initialized the

configuration. Unlike i-8K module, i-87K module uses the serial interface to communicate with MCU. In the following section, we will introduce the module parameters of i-87K briefly.

1. Type Code: Every operation mode has a unique type code in i-87K module. Its range is from 0 to 128. This code dominates the module's behaviors which are voltage input, current input, temperature input, digital I/O and so on. In general, most AI modules support parts of type code. For example, i-87017 supports type code 0x08 to 0x0D for voltage input.
2. Data Format: PROFI-8x55 provides four kinds of data format to broaden the applicability. They are engineer unit format, Hexadecimal format, percentage of full scale and Ohm in engineer unit. Most i-87K modules support the first three formats, and the last format is only supported by i-87013 and i-87015.

Besides the essential parameter mentioned above, a number of modules have some additional parameter.

Analog Module, e.g. i-87013, i-87015, i-87017, i-87017R, i-87017RC, i-87017ML, i-87018, i-87018R, i-87018Z, i-87019R, i-87022, i-87024 and i-87026, have an additional parameter "Diag Enable" to determine whether diagnosis report or not.

Among the analog modules, most of them share a common type code. It means that every channel operates at the same mode, and this manner will narrow its applicability. ICP DAS provides a number of modules supporting individual channel configuration to solve this problem; Analog Input modules i-87015, i-87018Z and i-87019R provide individual channel configuration. In contrast to analog input module, analog output modules i-87022 and i-87026 also support.

In **Counter/Frequency module** i-87082, type-code is fixed to 0x80, and its parameters are divided into several parts, as shown below:

1. Frequency Gate Time: Frequency gate time is also called "sampling period". It controls the signal-passing time. The counter takes effect during this period only, when AC-signal

supplied. After this period has elapsed, PROFI-8x55 transforms this count into appropriate count or frequency immediately and available in INPUT buffer.

2. High Level Trigger Voltage: It is the threshold of the minimum input voltage of logic “1” at the non-isolated input. The default value is 24(2.4 volt).
3. Gate Mode: Gate mode is like frequency gate time. The difference between them is that gate mode is for counter mode and frequency gate time is for frequency mode. Gate mode with 0 is low active which means the count-signal take into account if GATE pin is connected to logic “0”. Gate mode with 1 is like Gate mode with 0, but the mode is high active. Gate mode with 2 disables gate control and GATE pin is regardless.
4. Low Level Trigger Voltage: It is the threshold of the maximum input voltage of logic “0” at the non-isolated input. The default value is 8(0.8 volt).
5. Input Mode: This parameter is used to select the input type(isolated or non-isolated). The Isolated input is used to isolate the electromagnetic interference. The Isolated input uses photo-couple to pass the On/Off signal to i-87082 and the non-isolated input is directly accepted the input signal into i-87082.
6. Filter Enabled: Digital filter is provided by i-87082, and it can be enabled by setting this parameter to “Enable”.
7. Trigger Type of Channel 1 & 0: Trigger type is a parameter that control the polarity(Level Trigger) and direction(Edge Trigger) of “Clear”, ”Start”, “Stop” command. The default setting is Rising Edge Trigger. i-87082 can accept command only when the state of the function selection is changed from 0(Disable) to 1(Start) or 2(Stop) or 3(Clear). On the other hand, i-87082 accepts command only with the value of the function selection larger than 0 when the setting is High Level Trigger.

-
8. High Level Pulse Width: This parameter is an important factor of digital filter. It dominates the minimum pulse width that i-87082 can accept. If pulse width is shorter than that, it will be filtered. Otherwise, it can pass through. For example, if there is a signal 200 KHz with duty cycle 50% and high level pulse width is set to 3us, so measurement signal is limited to 166 KHz. The signal has been filtered, because the signal with 200 KHz has the pulse width of 2.5us and it is smaller than 3us.

Note: Formula of Maximum Frequency is equal to the inverse of pulse width divided by duty cycle.

9. Low Level Pulse Width: This parameter is the same as High Level Pulse width. Please refer to High Level Pulse Width.
10. Preset Count of Counter N: The preset count is a parameter with four bytes length. Preset count loaded when clear command issued or module reset. The range of this parameter is between 0 and 2^{32} . Notice that this setting will not be cleared by clear command. It only can be modified by Set_Prm telegram.
11. Maximum Count of Counter N: Maximum count is the threshold of the overflow. If the count value reaches this threshold, the channel will overflow and halt for clear. Otherwise, the counter continues counting. There is the difference between i-87082 and i-8080. The overflow presentation in i-8080 is an integer with 16 bits length just only one bit in i-87082.
- Note: When overflow flag is not cleared by users, counter will be held until clear command is issued. As soon as the channel overflows, the diagnostic message will reported.

Module Parameter for Output modules:

The output modules consist of Analog Output modules and Digital Output modules. They are different from the Input modules. Output modules have the Safe Value output mechanism. They output the Safe Value while PROFIBUS-DP has been changed to stop mode (or offline mode). The safe value can make

sure of the correctness of operating. There are three modes in safe value for users: Retain Last Value, Clear Output and Switch to Substitute Value.

Retain Last Value is that PROFI-8x55 retain the last valid output value for the corresponding channel.

Clear Output clear the corresponding channel to analog zero volt, analog zero ampere or digit logic "0".

Substitute Value follows Safe Mode Selection in module parameter, it must be obey the data range of corresponding data format and type-code.

The following figure shows the state flow of Wait Parameter.

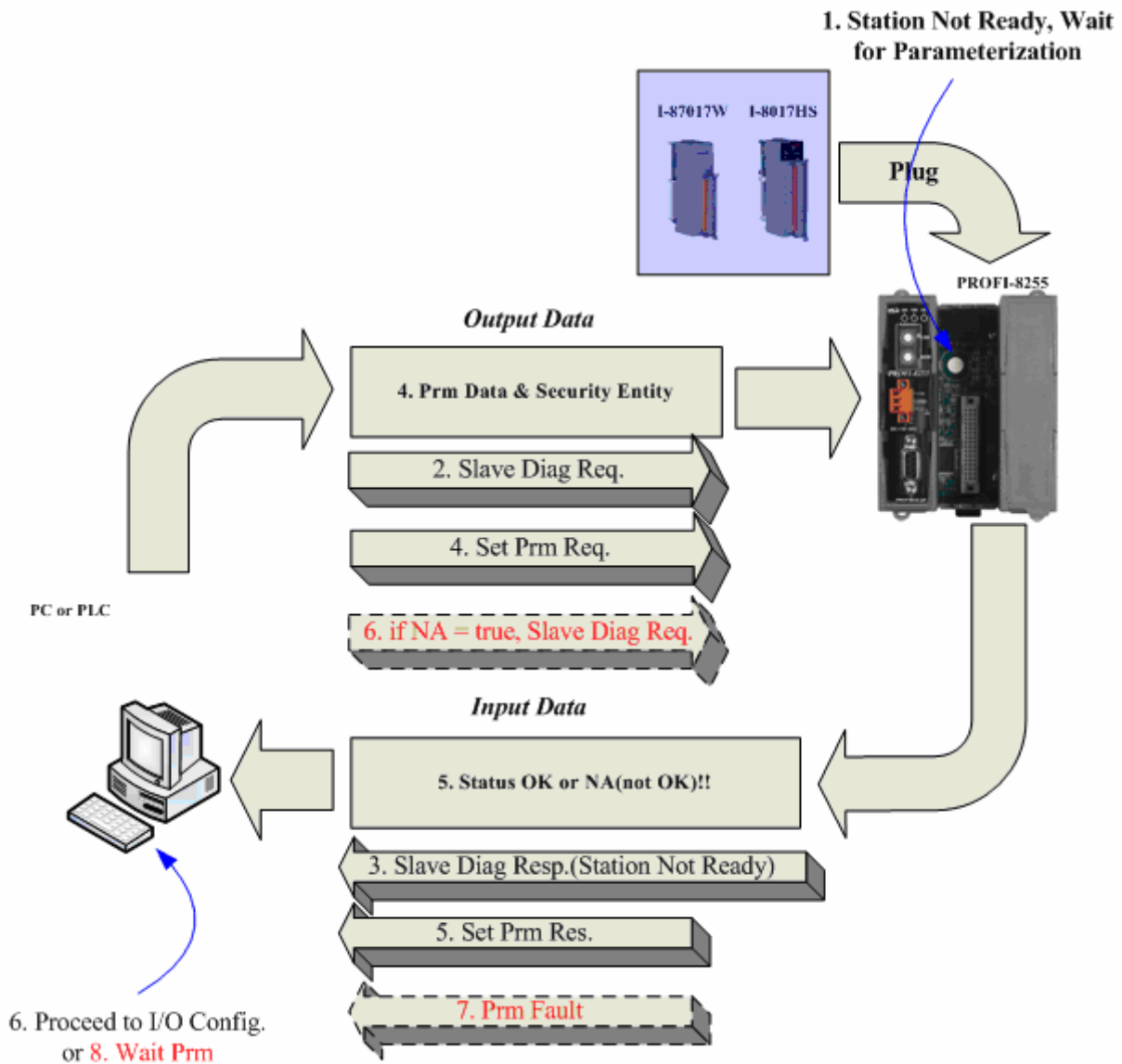

3.4. Wait Configuration

Configuration data is consisting of module-identifier. The main purpose is to check the configuration data from DP-Master against the stored one in PROFI-8x55. If these configuration data is coincident between PROFI-8x55 and DP-master, the DP-mode of PROFI-8x55 will switch from wait configuration to data exchange. Otherwise, PROFI-8x55 will report “Configuration Fault” and switch from wait configuration to wait parameter again.

Configuration Data

Configuration data specifies the number of input/output bytes of PROFI-8x55. PROFI-8x55 applies this information to allocate appropriate number of memory space for the module plugged in I/O expansion slot on PROFI-8x55. The maximum number of Input byte is 136 and 32 bytes for output. It is not permitted to exceed this quantity. The following table shows the module name and corresponding input byte, output byte and configuration code.

Module name	Input Length	Output Length	Cfg Code
i-8017HS – S ¹	16 Byte(8*2)	0	0x57
i-8017H(S) – D ²	32 Byte(16*2)	0	0x5F
i-8024	0	8 Byte	0x63
i-8037	0	2 Byte	0x21
i-8040	4 Byte	0	0x13
i-8041	0	4 Byte	0x23
i-8042	2 Byte	2 Byte	0x31
i-8050	2 Byte	2 Byte	0x31
i-8051	2 Byte	0	0x11
i-8052	1 Byte	0	0x10
i-8053	2 Byte	0	0x11
i-8054	1 Byte	1 Byte	0x30
i-8055	1 Byte	1 Byte	0x30
i-8056	0 Byte	2 Byte	0x21
i-8057	0 Byte	2 Byte	0x21
i-8058	1 Byte	0	0x10
i-8060	0	1 Byte	0x20

i-8063	1 Byte	1 Byte	0x30
i-8064	0	1 Byte	0x20
i-8065	0	1 Byte	0x20
i-8066	0	1 Byte	0x20
i-8068	0	1 Byte	0x20
i-8069	0	1 Byte	0x20
i-8077	1 Byte	1 Byte	0x20
i-8080	48Byte(8*6)	1 Byte	0xC0,0x00,0x2F
i-87013	8 Byte(4*2)	0	0x53
i-87015(P)	14 Byte(7*2)	0	0x56
i-87017(R)	16 Byte(8*2)	0	0x57
i-87017RC	16 Byte(8*2)	0	0x57
i-87017ML	16 Byte(8*2)	0	0x57
i-87018(R)	16 Byte(8*2)	0	0x57
i-87018(R) (w/ CJC Read/Offset)	18 Byte(8*2+2 ^{@1})	2 Byte(0+2 ^{@2})	0x57,0xC0,0x01, 0x40
i-87018Z	20 Byte(10*2)	0	0x59
i-87018Z (w/ CJC Read/Offset)	22 Byte (10*2+2 ^{@1})	3 Byte(0+3 ^{@2})	0x59,0xC0,0x02, 0x40
i-87019R	16 Byte(8*2)	0	0x57
i-87019R (w/ CJC Read/Offset)	18 Byte(8*2+2 ^{@1})	3 Byte(0+3 ^{@2})	0x57,0xC0,0x02, 0x40
i-87022	0	4 Byte(2*2)	0x61
i-87024	0	8 Byte(4*2)	0x63
i-87026	0	4 Byte(2*2)	0x61
i-87040(W)	4 Byte	0	0x13
i-87040(W)(w/ Cnt)	68 Byte(4+32*2)	5 Byte(0+4)	0x13,0xC0,0x03, 0x5F
i-87041(W)	0	4 Byte	0x23
i-87046W	2 Byte	0	0x11
i-87046W(w/ Cnt)	34 Byte(2+16*2)	2Byte(0+2)	0x11,0xC0,0x01, 0x4F
i-87051(W)	2 Byte	0	0x11
i-87051(W)(w/ Cnt)	34 Byte(2+16*2)	2 Byte(0+2)	0x11,0xC0,0x01, 0x4F
i-87052(W)	1 Byte	0	0x10
i-87052(W)(w/ Cnt)	17 Byte(1+8*2)	1 Byte(0+1)	0x10,0xC0,0x00, 0x47

i-87053(W)	2 Byte	0	0x11
i-87053(W)(w/ Cnt)	34 Byte(2+16*2)	2 Byte(0+2)	0x11,0xC0,0x01, 0x4F
i-87054(W)	1 Byte	1 Byte	0x30
i-87054(W)(w/ Cnt)	17 Byte(1+8*2)	2 Byte(1+1)	0x30,0xC0,0x00, 0x47
i-87055(W)	1 Byte	1 Byte	0x30
i-87055(W)(w/ Cnt)	17 Byte(1+8*2)	2 Byte(1+1)	0x30,0xC0,0x00, 0x47
i-87057(W)	0	2 Byte	0x21
i-87058(W)	1 Byte	0	0x10
i-87058(W)(w/ Cnt)	17 Byte(1+8*2)	1 Byte(0+1)	0x10,0xC0,0x00, 0x47
i-87059W	1 Byte	0	0x10
i-87059W(w/ Cnt)	17 Byte(1+8*2)	1 Byte(0+1)	0x10,0xC0,0x00, 0x47
i-87063(W)	1 Byte	1 Byte	0x30
i-87063(w/ Cnt)	9 Byte(1+4*2)	2 Byte(1+1)	0x30,0xC0,0x00, 0x43
i-87064(W)	0	1 Byte	0x20
i-87065(W)	0	1 Byte	0x20
i-87066(W)	0	1 Byte	0x20
i-87068(W)	0	1 Byte	0x20
i-87069(W)	0	1 Byte	0x20
i-87082(W)	9 Byte	1 Byte(1 OR 1)	0x53,0x10,0x20

-S¹ means single-end input mode

-D² means differential input mode

- Data length of analog input module = channel number * data length per channel.

-Data length of digital input module = the length of basic input data + channel number * data length of counter per channel.

-Data length of digital output module = the length of basic output data + optional data length of clear command.

-OR means DO data have combined with Clear command into one byte.

-@¹ means the data length of CJC temperature.

-@² means the data length of CJC offset setting command.

The figure is shown below the state flow of Wait Configuration.

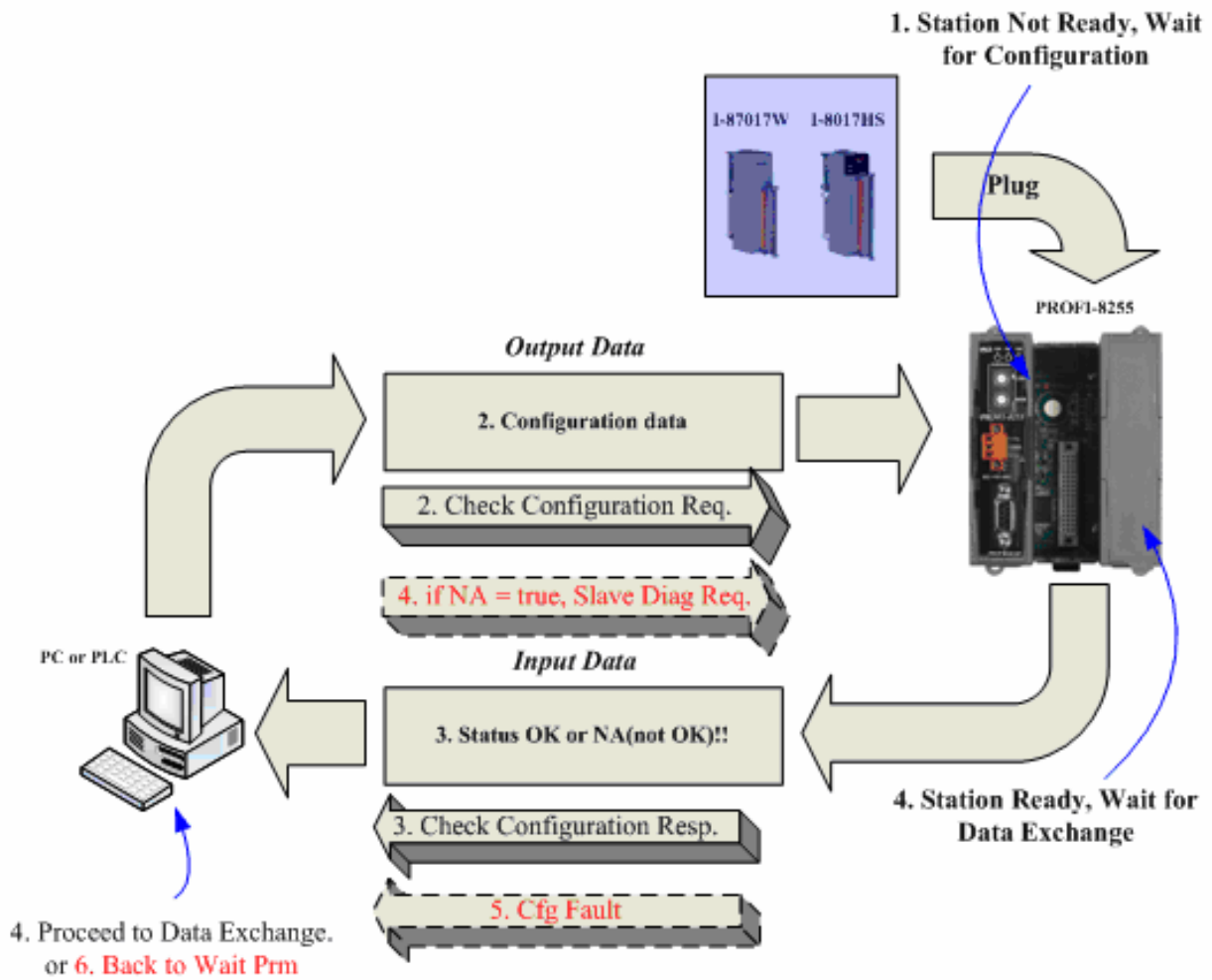

3.5. Data Exchange

After the parameterization and configuration processes have been accomplished, PROFI-8X55 exchanges I/O data with the DP-Master cyclically. In following section, we introduce the Numeric Representation and Byte Order briefly.

Numeric Representation

Among Analog Input modules or Analog Output modules, there are many numeric representations, include Engineer-Unit, Hexadecimal, Percentage of Full Scale and Ohm in Engineer-Unit. We will introduce the numeric representation in i-8K module and i-87K module.

i-8K Series

Analog Input Module (i-8017H, i-8017HS)

+/- 10 V :

The range for Engineer-Unit: -10000~10000(mV)

The range for 2's complement hexadecimal: 0000~1FFF (0v ~ 10v),
2000~3FFF (-10v~1.22mV)

Conversion from Engineer-Unit to 2's complement hexadecimal:

$$HexValue = \frac{EngineerValue}{10000} \times 8192 - 1 \quad \text{if } 0 \leq EngineerValue \leq 10000$$

$$HexValue = \frac{EngineerValue}{10000} \times 8192 + 16384 \quad \text{if } -10000 \leq EngineerValue < 0$$

Measurement Value	Decimal	Hexadecimal
+10v(Engineer mode)	10000	0x2710
0v(Engineer mode)	0	0x0000
-10v(Engineer mode)	-10000	0xD8F0
+10v(Hex mode)	8191	0x1FFF
+5v(Hex mode)	4095	0x1000
0v(Hex mode)	0	0x0000
-5v(Hex Mode)	12288	0x3000
-10v(Hex mode)	8192	0x2000

+/- 5 V :

The range for Engineer-Unit: -5000~5000(mV)

The range for 2's complement hexadecimal: 0000~1FFF (0v ~ 5v),
2000~3FFF (-5v~0.61mV)

Conversion from Engineer-Unit to 2's complement hexadecimal:

$$\text{HexValue} = \frac{\text{EngineerValue}}{5000} \times 8192 - 1 \quad \text{if } 0 \leq \text{EngineerValue} \leq 5000$$

$$\text{HexValue} = \frac{\text{EngineerValue}}{5000} \times 8192 + 16384 \quad \text{if } -5000 \leq \text{EngineerValue} < 0$$

Measurement Value	Decimal	Hexadecimal
+5v(Engineer mode)	5000	0x1388
0v(Engineer mode)	0	0x0000
-5v(Engineer mode)	-5000	0xEC78
+5v(Hex mode)	8191	0x1FFF
+2.5v(Hex mode)	4095	0x1000
0v(Hex mode)	0	0x0000
-2.5v(Hex mode)	12288	0x3000
-5v(Hex Mode)	8192	0x2000

+/- 2.5 V :

The range for Engineer-Unit: -2500~2500(mV)

The range for 2's complement hexadecimal: 0000~1FFF (0v ~ 2.5v),
2000~3FFF (-2.5v~0.3mV)

Conversion from Engineer-Unit to 2's complement hexadecimal:

$$\text{HexValue} = \frac{\text{EngineerValue}}{2500} \times 8192 - 1 \quad \text{if } 0 \leq \text{EngineerValue} \leq 2500$$

$$\text{HexValue} = \frac{\text{EngineerValue}}{2500} \times 8192 + 16384 \quad \text{if } -2500 \leq \text{EngineerValue} < 0$$

Measurement Value	Decimal	Hexadecimal
+2.5v(Engineer mode)	2500	0x09C4
0v(Engineer mode)	0	0x0000
-2.5v(Engineer mode)	-2500	0xF63C
+2.5v(Hex mode)	8191	0x1FFF
+1.25v(Hex mode)	4095	0x1000
0v(Hex mode)	0	0x0000
-1.25v(Hex mode)	12288	0x3000
-2.5v(Hex Mode)	8192	0x2000

+/- 1.25 V :

The range for Engineer-Unit: -1250~1250(mV)

The range for 2's complement hexadecimal: 0000~1FFF (0v ~ 1.25v),
2000~3FFF (-1.25v~0.15mV)

Conversion from Engineer-Unit to 2's complement hexadecimal:

$$HexValue = \frac{EngineerValue}{1250} \times 8192 - 1 \quad \text{if } 0 \leq EngineerValue \leq 1250$$

$$HexValue = \frac{EngineerValue}{1250} \times 8192 + 16384 \quad \text{if } -1250 \leq EngineerValue < 0$$

Measurement Value	Decimal	Hexadecimal
+1.25v(Engineer mode)	1250	0x04E2
0v(Engineer mode)	0	0x0000
-1.25v(Engineer mode)	-1250	0xFB1E
+1.25v(Hex mode)	8191	0x1FFF
+0.675v(Hex mode)	4095	0x1000
0v(Hex mode)	0	0x0000
-0.675v(Hex mode)	12288	0x3000
-1.25v(Hex Mode)	8192	0x2000

+/- 20 mA :

The range for Engineer-Unit: -20000~20000(mV)

The range for 2's complement hexadecimal: 0000~1FFF (0mA ~
20mA), 2000~3FFF (-20mA ~ -2.44uA)

Conversion from Engineer-Unit to 2's complement hexadecimal:

$$HexValue = \frac{EngineerValue}{20000} \times 8192 - 1 \quad \text{if } 0 \leq EngineerValue \leq 20000$$

$$HexValue = \frac{EngineerValue}{20000} \times 8192 + 16384 \quad \text{if } -20000 \leq EngineerValue < 0$$

Measurement Value	Decimal	Hexadecimal
20mA(Engineer mode)	20000	0x4E20
10mA(Engineer mode)	10000	0x2710
0v(Engineer mode)	0	0x0000
20mA(Hex mode)	8191	0x1FFF
10mA(Hex mode)	4095	0x1000
0v(Hex mode)	0	0x0000

Analog output module (I-8024) :

+/- 10 V :

The range for Engineer-Unit: -10000~10000(mV)

The range for 2's complement hexadecimal: 0000~7FFF (0v ~ 10v),
8000~FFFF (-10v~0.3mV)

Conversion from Engineer-Unit to two's complement hexadecimal:

$$HexValue = \frac{EngineerValue}{10000} \times 32768 - 1 \quad \text{if } 0 \leq EngineerValue \leq 10000$$

$$HexValue = \frac{EngineerValue}{10000} \times 32768 + 65536 \quad \text{if } -10000 \leq EngineerValue < 0$$

Measurement Value	Decimal	Hexadecimal
10v(Engineer mode)	10000	0x2710
0v(Engineer mode)	0	0x0000
-10v(Engineer mode)	-10000	0xD8F0
10v(Hex mode)	32767	0x7FFF
0v(Hex mode)	0	0x1000
-10v(Hex mode)	-32768	0x8000

+ 20mA :

The range for Engineer-Unit: -20000~20000(mV)

The range for 2's complement hexadecimal: 0000~7FFF (0v ~ +20mA)

Conversion from Engineer-Unit to 2's complement hexadecimal:

$$HexValue = \frac{EngineerValue}{20000} \times 32768 - 1$$

Measurement Value	Decimal	Hexadecimal
20mA(Engineer mode)	20000	0x4E20
0mA(Engineer mode)	0	0x0000
20mA(Hex mode)	32767	0x7FFF
0mA(Hex mode)	0	0x0000

i-87K Module

i-87K I/O modules are serial communication-based, they provide various data formats. For example, Engineer-Unit, Percentage of Full Scale, 2's Complement Hexadecimal and Ohm format are supported in these modules. The relationship between the measurement type and the measurement unit is represented in the following table.

Type	Conditions	Unit
Voltage/Current	$-10V \leq \text{Voltage} \leq 10V$ $20mA \geq \text{Current} \geq -20mA$	milli-Volt(mV) micro-Ampere(μA)
Voltage	$\text{Voltage} \geq 10V$ or $\text{Voltage} \leq -10V$	Volt(V)
Temperature	RTD/Pt/Ni/Cu-RTD/Thermocouple	0.1 Degree Celsius
Resistor	RTD/Pt/Ni/Cu-RTD/Thermocouple	0.1 Ohm(0.1 Ω)

i-87013 and i-87015 Analog Input Module

Type-Code	Input Range	Data Format	Max.	Min
20	Pt-100 (a = 0.00385) -100°C to 100°C	Engineer Unit	+1000	-1000
		% of FSR	+10000	-10000
		2's complement HEX	7FFF	8000
		Ohm	+1385	+0602
21	Pt-100 (a = 0.00385) 0°C to 100°C	Engineer Unit	+1000	+0000
		% of FSR	+10000	+00000
		2's complement HEX	7FFF	0000
		Ohm	+1385	+1000
22	Pt-100 (a = 0.00385) 0°C to 200°C	Engineer Unit	+2000	+0000
		% of FSR	+10000	+00000
		2's complement HEX	7FFF	0000
		Ohm	+1758	+1000
23	Pt-100 (a = 0.00385) 0°C to 600°C	Engineer Unit	+6000	+0000
		% of FSR	+10000	+00000
		2's complement HEX	7FFF	0000
		Ohm	+3135	+1000
24	Pt-100 (a = 0.003916) -100°C to 100°C	Engineer Unit	+1000	-1000
		% of FSR	+10000	-10000
		2's complement HEX	7FFF	8000
		Ohm	+1391	+0595

25	Pt-100 (a = 0.003916) 0°C to 100°C	Engineer Unit	+1000	+0000
		% of FSR	+10000	+00000
		2's complement HEX	7FFF	0000
		Ohm	+1391	+1000
26	Pt-100 (a = 0.003916) 0°C to 200°C	Engineer Unit	+2000	+0000
		% of FSR	+10000	+00000
		2's complement HEX	7FFF	0000
		Ohm	+1771	+1000
27	Pt-100 (a = 0.003916) 0°C to 600°C	Engineer Unit	+6000	+0000
		% of FSR	+10000	+00000
		2's complement HEX	7FFF	0000
		Ohm	+3172	+1000
28	Nickel 120 -80°C to 100 °C	Engineer Unit	+1000	-0800
		% of FSR	+10000	-08000
		2's complement HEX	7FFF	999A
		Ohm	+2006	+1206
29	Nickel 120 0°C to 100°C	Engineer Unit	+1000	+0000
		% of FSR	+10000	+00000
		2's complement HEX	7FFF	0000
		Ohm	+2006	+1206
2A	Pt-1000(a = 0.00385) -200°C to 600°C	Engineer Unit	+6000	-2000
		% of FSR	+10000	-03333
		2's complement HEX	7FFF	D556
		Ohm	+31371	+01852
2B ^{*1}	Cu 100 (a = 0.00421) -20°C to 150°C	Engineer Unit	+1500	-0200
		% of FSR	+10000	-01333
		2's complement HEX	7FFF	EEEE
		Ohm	+1631	+0915
2C ^{*1}	Cu 100 a = 0.00421 0°C to 200°C	Engineer Unit	+2000	0000
		% of FSR	+10000	-00000
		2's complement HEX	7FFF	0000
		Ohm	+1677	+0903
2D ^{*1}	Cu 1000 a = 0.00421 -20°C to 150°C	Engineer Unit	+1500	-0200
		% of FSR	+10000	-01333
		2's complement HEX	7FFF	EEEE
		Ohm	+16317	+09156
2E ^{*2}	Pt 100 a = 0.00385 -200°C to +200°C	Engineer Unit	+2000	-2000
		% of FSR	+10000	-10000

		2's complement HEX	7FFF	8000
		Ohm	+1758	+0184
2F ^{*2}	Pt 100 a = 0.003916 -200°C to +200°C	Engineer Unit	+2000	-2000
		% of FSR	+10000	-10000
		2's complement HEX	7FFF	8000
		Ohm	+1771	+0171
80 ^{*2}	Pt 100 a = 0.00385 -200°C to +600°C	Engineer Unit	+6000	-2000
		% of FSR	+10000	-03333
		2's complement HEX	7FFF	D556
		Ohm	+3135	+0184
81 ^{*2}	Pt 100 a = 0.003916 -200°C to +600°C	Engineer Unit	+6000	-2000
		% of FSR	+10000	-03333
		2's complement HEX	7FFF	D556
		Ohm	+3172	+0171

* 1: Type 2B, 2C and 2D are only available with i-87015.

* 2: Type 2E, 2F, 80 and 81 are only available with the i-87015 firmware version A1.10 and later, i-87013 firmware version B1.3 and later.

i-87017/i-87017R Analog Input Module

Type-Code	Input Range	Data Format	Max.	Min
08	-10V to +10V	Engineer Unit	+10000	-10000
		% of FSR	+10000	-10000
		2's Complement HEX	7FFF	8000
09	-5V to +5V	Engineer Unit	+50000	-50000
		% of FSR	+10000	-10000
		2's Complement HEX	7FFF	8000
0A	-1V to +1V	Engineer Unit	+10000	-10000
		% of FSR	+10000	-10000
		2's Complement HEX	7FFF	8000
0B	-500mV to +500mV	Engineer Unit	+500	-500
		% of FSR	+10000	-10000
		2's Complement HEX	7FFF	8000
0C	-150mV to +150mV	Engineer Unit	+150	-150
		% of FSR	+10000	-10000
		2's Complement HEX	7FFF	8000
0D	-20mA to +20mA	Engineer Unit	+20000	-20000

		% of FSR	+10000	-10000
		2's Complement HEX	7FFF	8000

i-87017RC Analog Input Module

Type-Code	Input Range	Data Format	Max.	Min
07	-4mA to +20mA	Engineer Unit	+04000	+20000
		% of FSR	+10000	-10000
		2's Complement HEX	7FFF	8000
0D	-20mA to +20mA	Engineer Unit	+20000	-20000
		% of FSR	+10000	-10000
		2's Complement HEX	7FFF	8000
1A	+0A to +20mA	Engineer Unit	+00000	+20000
		% of FSR	+10000	-10000
		2's Complement HEX	7FFF	8000

i-87017ML Analog Input Module

Type-Code	Input Range	Data Format	Max.	Min
1B	-150V to +150V	Engineer Unit	+150	-150
		% of FSR	+10000	-10000
		2's Complement HEX	7FFF	8000
1C	-50V to +50V	Engineer Unit	+50	-50
		% of FSR	+10000	-10000
		2's Complement HEX	7FFF	8000

i-87018/i-87018R Analog Input Module

Type-Code	Input Range	Data Format	Max.	Min
00	-15mV to +15mV	Engineer Unit	+15	-15
		% of FSR	+10000	-10000
		2's Complement HEX	7FFF	8000
01	-50mV to +50mV	Engineer Unit	+50	-50
		% of FSR	+10000	-10000
		2's Complement HEX	7FFF	8000
02	-100mV to +100mV	Engineer Unit	+100	-100
		% of FSR	+10000	-10000
		2's Complement HEX	7FFF	8000
03	-500mV to +500mV	Engineer Unit	+500	-500

		% of FSR	+10000	-10000
		2's Complement HEX	7FFF	8000
04	-1V to +1V	Engineer Unit	+10000	-10000
		% of FSR	+10000	-10000
		2's Complement HEX	7FFF	8000
05	-25V to +25V	Engineer Unit	+25000	-25000
		% of FSR	+10000	-10000
		2's Complement HEX	7FFF	8000
06	-20mA to +20mA	Engineer Unit	+20000	-20000
		% of FSR	+10000	-10000
		2's Complement HEX	7FFF	8000
0E	J Type	Engineer Unit	+7600	-2100
		% of FSR	+10000	-02763
		2's Complement HEX	7FFF	DCA2
0F	K Type	Engineer Unit	+13720	-02700
		% of FSR	+10000	-01968
		2's Complement HEX	7FFF	E6D0
10	T Type	Engineer Unit	+4000	-2700
		% of FSR	+10000	-06750
		2's Complement HEX	7FFF	A99A
11	E Type	Engineer Unit	+10000	-02700
		% of FSR	+10000	-02700
		2's Complement HEX	7FFF	DD71
12	R Type	Engineer Unit	+17680	+00000
		% of FSR	+10000	+00000
		2's Complement HEX	7FFF	0000
13	S Type	Engineer Unit	+17680	+00000
		% of FSR	+10000	+00000
		2's Complement HEX	7FFF	0000
14	B Type	Engineer Unit	+18200	+00000
		% of FSR	+10000	+00000
		2's Complement HEX	7FFF	0000
15	N Type	Engineer Unit	+13000	-02700
		% of FSR	+10000	-02077
		2's Complement HEX	7FFF	E56B

16	C Type	Engineer Unit	+23200	+00000
		% of FSR	+10000	+00000
		2's Complement HEX	7FFF	0000
17	L Type	Engineer Unit	+8000	-2000
		% of FSR	+10000	-02500
		2's Complement HEX	7FFF	E000
18	M Type	Engineer Unit	+1000	-2000
		% of FSR	+05000	-10000
		2's Complement HEX	4000	8000
19	L Type DIN43710	Engineer Unit	+9000	-2000
		% of FSR	+10000	-02222
		2's Complement HEX	7FFF	E38F

i-87019R Analog Input Module

Type-Code	Input Range	Data Format	Max.	Min
00	-15mV to +15mV	Engineer Unit	+15	-15
		% of FSR	+10000	-10000
		2's Complement HEX	7FFF	8000
01	-50mV to +50mV	Engineer Unit	+50	-50
		% of FSR	+10000	-10000
		2's Complement HEX	7FFF	8000
02	-100mV to +100mV	Engineer Unit	+100	-100
		% of FSR	+10000	-10000
		2's Complement HEX	7FFF	8000
03	-500mV to +500mV	Engineer Unit	+500	-500
		% of FSR	+10000	-10000
		2's Complement HEX	7FFF	8000
04	-1V to +1V	Engineer Unit	+10000	-10000
		% of FSR	+10000	-10000
		2's Complement HEX	7FFF	8000
05	-2.5V to +2.5V	Engineer Unit	+25000	-25000
		% of FSR	+10000	-10000
		2's Complement HEX	7FFF	8000
06	-20mA to +20mA	Engineer Unit	+20000	-20000
		% of FSR	+10000	-10000

		2's Complement HEX	7FFF	8000
08	-10V to +10V	Engineer Unit	+10000	-10000
		% of FSR	+10000	-10000
		2's Complement HEX	7FFF	8000
09	-5V to +5V	Engineer Unit	+50000	-50000
		% of FSR	+10000	-10000
		2's Complement HEX	7FFF	8000
0A	-1V to +1V	Engineer Unit	+10000	-10000
		% of FSR	+10000	-10000
		2's Complement HEX	7FFF	8000
0B	-500mV to +500mV	Engineer Unit	+500	-500
		% of FSR	+10000	-10000
		2's Complement HEX	7FFF	8000
0C	-150mV to +150mV	Engineer Unit	+150	-150
		% of FSR	+10000	-10000
		2's Complement HEX	7FFF	8000
0D	-20mA to +20mA	Engineer Unit	+20000	-20000
		% of FSR	+10000	-10000
		2's Complement HEX	7FFF	8000
0E	J Type	Engineer Unit	+7600	-2100
		% of FSR	+10000	-02763
		2's Complement HEX	7FFF	DCA2
0F	K Type	Engineer Unit	+13720	-02700
		% of FSR	+10000	-01968
		2's Complement HEX	7FFF	E6D0
10	T Type	Engineer Unit	+4000	-2700
		% of FSR	+10000	-06750
		2's Complement HEX	7FFF	A99A
11	E Type	Engineer Unit	+10000	-02700
		% of FSR	+10000	-02700
		2's Complement HEX	7FFF	DD71
12	R Type	Engineer Unit	+17680	+00000
		% of FSR	+10000	+00000
		2's Complement HEX	7FFF	0000
13	S Type	Engineer Unit	+17680	+00000

		% of FSR	+10000	+00000
		2's Complement HEX	7FFF	0000
14	B Type	Engineer Unit	+18200	+00000
		% of FSR	+10000	+00000
		2's Complement HEX	7FFF	0000
15	N Type	Engineer Unit	+13000	-02700
		% of FSR	+10000	-02077
		2's Complement HEX	7FFF	E56B
16	C Type	Engineer Unit	+23200	+00000
		% of FSR	+10000	+00000
		2's Complement HEX	7FFF	0000
17	L Type	Engineer Unit	+8000	-2000
		% of FSR	+10000	-02500
		2's Complement HEX	7FFF	E000
18	M Type	Engineer Unit	+1000	-2000
		% of FSR	+05000	-10000
		2's Complement HEX	4000	8000
19	L Type DIN43710	Engineer Unit	+9000	-2000
		% of FSR	+10000	-02222
		2's Complement HEX	7FFF	E38F

i-87022 Analog Output Module

Type-Code	Input Range	Data Format	Max.	Min
0	0mA to 20mA	Engineer Unit	20000	00000
		% of FSR	+10000	+00000
		Hexadecimal	FFF	000
1	4 mA to 20mA	Engineer Unit	20000	04000
		% of FSR	+10000	+00000
		Hexadecimal	FFF	000
2	0V to 10V	Engineer Unit	10000	00000
		% of FSR	+10000	+00000
		Hexadecimal	FFF	000

i-87026 Analog Output Module

Type-Code	Input Range	Data Format	Max.	Min
0	0 mA to 20mA	Engineer Unit	20000	00000
		% of FSR	+10000	+00000
		Hexadecimal	FFFF	0000
1	4 mA to 20mA	Engineer Unit	20000	04000
		% of FSR	+10000	+00000
		Hexadecimal	FFFF	0000
2	0V to 10V	Engineer Unit	10000	00000
		% of FSR	+10000	+00000
		Hexadecimal	FFFF	0000

i-87024 Analog Output(Only support Engineer Unit)

Type-Code	Input Range	Data Format	Max.	Min
30	0 mA to 20mA	Engineer Unit	+20000	+00000
31	4 mA to 20mA	Engineer Unit	+20000	+04000
32	0V to 10V	Engineer Unit	+10000	+00000
33	-10V to 10V	Engineer Unit	+10000	-10000
34	0V to 5V	Engineer Unit	+05000	+00000
35	-5V to 5V	Engineer Unit	+05000	-05000

Byte Order and Data Address

i-8K Series & i-87K Series - General Digital Input / Output

The general digital input or output module arrange its data with big-endian in follow (i-8040 or i-87040).



The little-endian is shown as follows.



i-87K Series - Digital Input w/ Counter

The i-87K digital input modules not only provide a basic input function but also have a function of counter which maximum count can be up to 65535. You can choose it which label “i-870XX w/ Counter Func.” in GSD file. The figure shows below is data arrangement of i-87040 w/ Counter.

Data Arrangement of Digital Input w/ Counter: Input Part

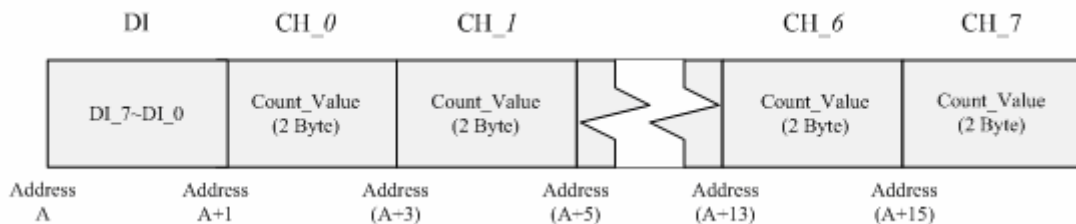

Data Arrangement of Digital Input w/ Counter: Output Part

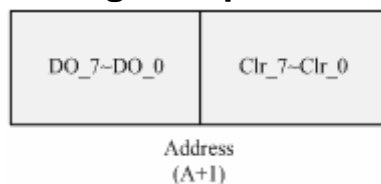

i-8K Series & i-87K Series – General Analog Input (w/o CJC Read/Offset) and Analog Output

Analog module transforms the continuous signal or discrete signal into another type signal. Discrete signal always 2 byte per channel. For example, the following figure shows data arrangement of i-87024(i-8024).

Note: The order of I/O data is ranked by channel's identifier, so the channel with lower ID has priority over the channel with higher ID.

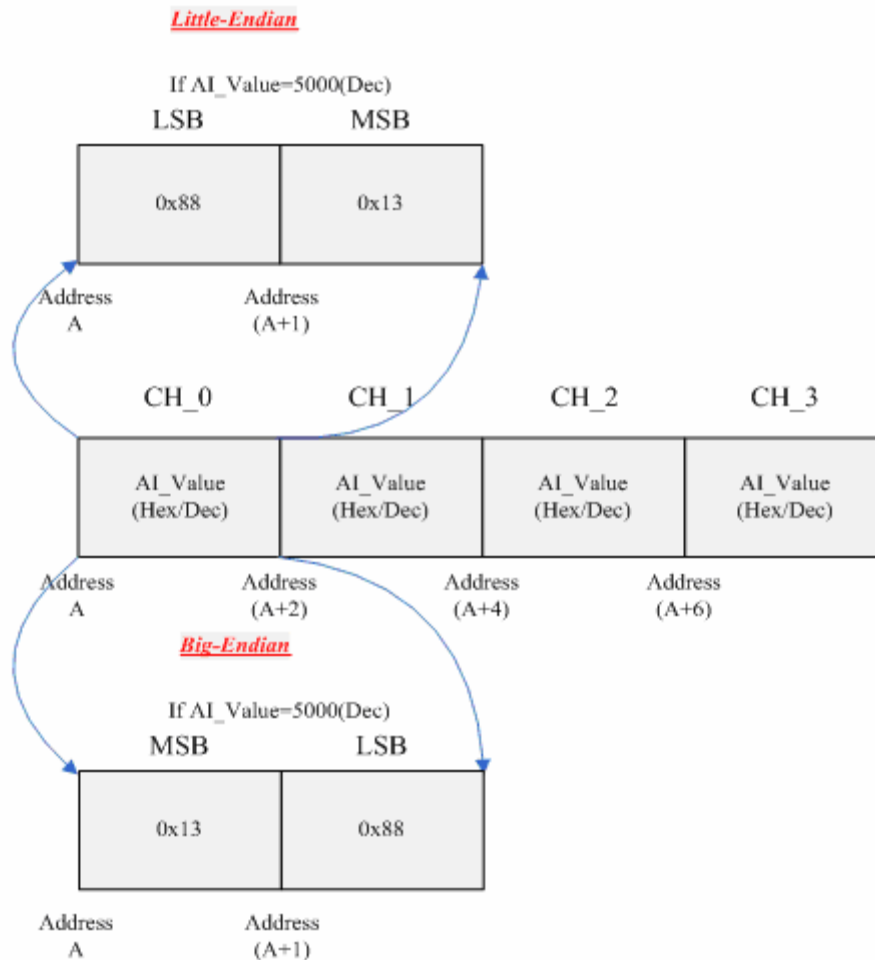

i-8K Series & i-87K Series – General Analog Input (w/ CJC Read/Offset)

The temperature is a kind of analog signals. i-87K modules(i-87013, i-87015, i-87018 and i-87019) provide several solutions to measure the different sensors or range. Most of temperature sensor return the absolute value, but the thermocouple is different, it return the relative-value between hot-junction and cold junction. The thermocouples measure the temperature difference between hot junction point and cold junction point. But the ordinary thermocouples have no cold-junction point so it can not measure the accuracy

temperature using hot junction point only. In order to solve this problem, i-87K modules which use thermocouple to measure temperature support the Cold Junction Compensation by an internal temperature sensor. Although CJC's problem has been dealt, there is a problem still remained. The problem is that CJC temperature sensor has some varieties compare to practical temperature. Therefore, PROFI-8x55 provides a byte to calibration this difference. The following figure is data arrangement of i-87024 w/ CJC Read/Offset.

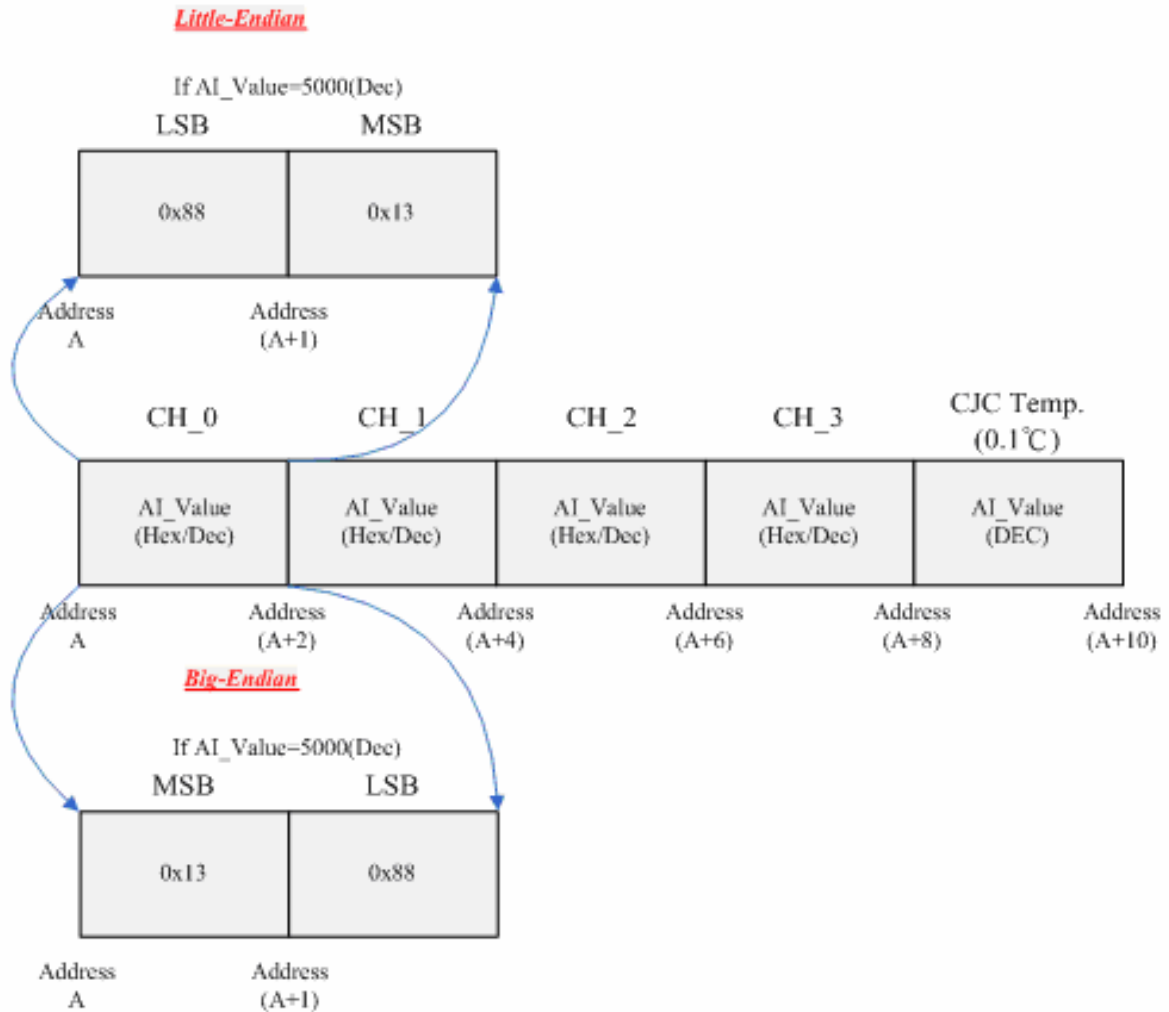

The bytes of CJC offset detail describes as follows. There are two kinds of data length, 2 bytes and 3 bytes. The data length with 2 byte is used in module without individual channel configure and the data length with 3 byte is used in module with individual channel configure.

Bit Arrangement of CJC-Offset using Big-Endian

Bit.	Byte0.3~0	Byte1.7	Byte1.6	Byte1.5	Byte 1.4~Byte2.0
Func.	Chn.Sel.	Ena/Disa	Reserved	Sign	Offset-Value(0.01°C)

Bit Arrangement of CJC-Offset using Little-Endian

Bit.	Byte2.3~0	Byte1.7	Byte1.6	Byte1.5	Byte 1.4~Byte0.0
Func.	Chn.Sel.	Ena/Disa	Reserved	Sign	Offset-Value

Func.	Meaning	Description
Chn.Sel.(8bits) *	Channel Selection(0~8)	CJC Calibration Channel
Ena/Disa(1bit)	Enable/Disable	CJC Calibration Enable
Reserved(1bit)	Reserved	
Sign(1bit)	Sign (0 -> Pos, 1-> Neg)	Plus or minus offset value to calibration temperature
Offset-Value (13bit)	Offset value	Offset value compare to practice temperature

*: This field only available in i-87019R. "Chn.Sel." from 0 to 7 is corresponding to channel 0 to channel 7 and Chn.Sel. 8 is a broadcast channel ID that available to all channel.

Note: The maximum offset for i-87019R is 4096 and its unit is 0.01°C; The maximum offset for i-87108Z is 127 and its unit is 0.1°C

Note: While Enable/Disable is set ("1"), the calibration works.

Note: The length of output data in i-87018(R/W) is 2 bytes, and 3 bytes for i-87019R and i-87018Z.

i-8K Series & i-87K Series – Counter/Frequency

i-8080 and i-87082 are counter/frequency module, the differences described in the following table.

Module Name	i-8080	i-87082
Count Range	0~2 ⁴⁸ (Count+Overflow)	0~2 ³² (Count)
Frequency Range	0~450KHz	0~100KHz
Overflow	0~2 ¹⁶	0~1
Channel Number	8(Up & Freq) or 4(others)	2

The following figure shows the data arrangement of input data. It includes the normal count (4 Bytes) and overflow count (2bytes).

Data arrangement of input part in i-8080 module

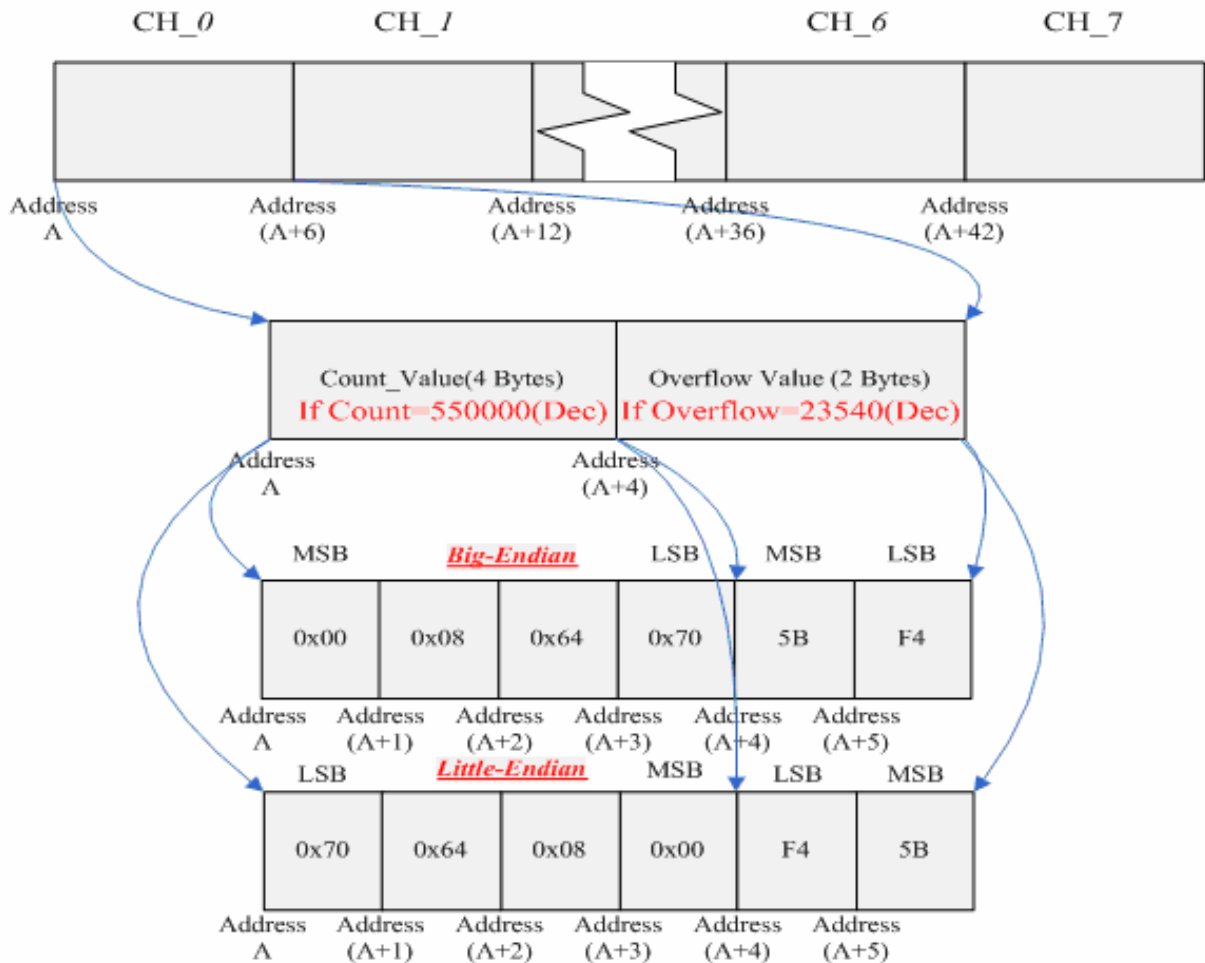

There are nine input bytes in i-87082. The last byte indicates the status of the counter, and the others are the count value of each channel. The bit arrangement of the last input byte is shown below

i-87082 – bit arrangement of the last input byte (Overflow)

Bit.	Bit7	Bit6	Bit5	Bit4	Bit3	Bit2	Bit1	Bit0	
Func.	Reserved					CH1.Overflow	CH0.Overflow		

The following figure shows the data arrangement of the input bytes in i-87082 module.

i-87082 - Data arrangement of the input bytes (Cnt/Freq)

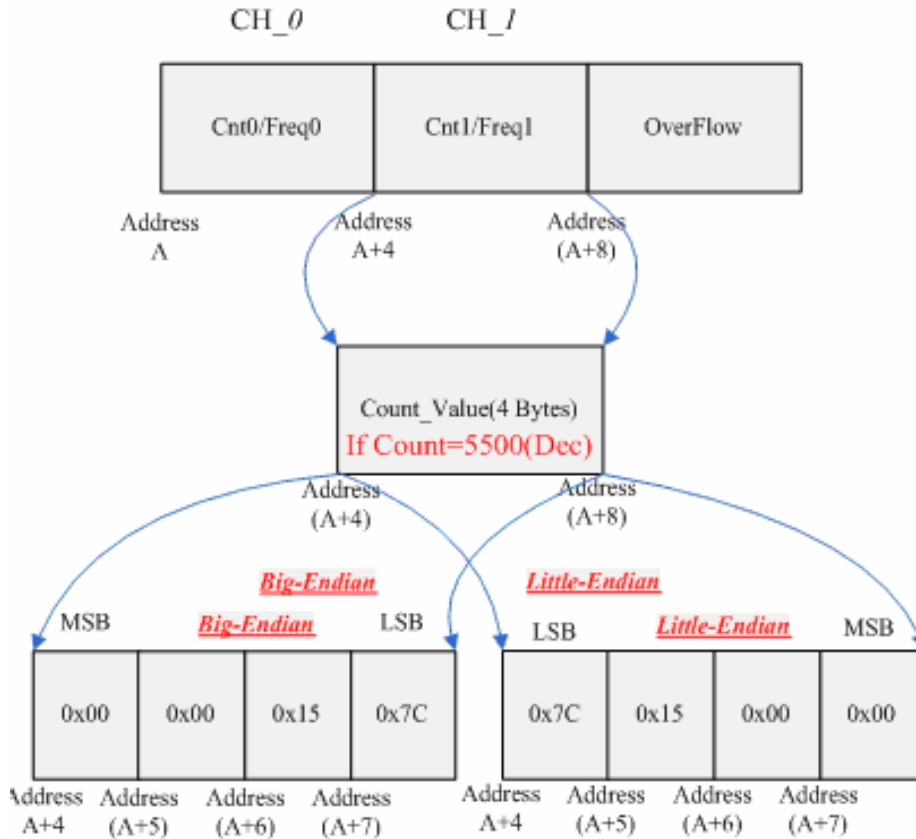

There is an additional function in both of i-8080 and i-87082. It is “Clear Count” command. The clear command of i-8080 is the same as i-87082. It just set the corresponding bit to “1”(Level-trigger) or set it from “0” to “1” (Edge-trigger) then the corresponding channel count will clear soon, as show below.

Bit Arrangement of Output Data in i-8080(1 Byte)

Bit.	7	6	5	4	3	2	1	0
Func.	Clr7	Clr6	Clr5	Clr4	Clr3	Clr2	Clr1	Clr0

Func.	Meaning	Description
ClrN	Clear Count of Channel N	Clear both overflow and count value

i-87082 provide more functionality than i-8080. They are “Start Count” and ”Stop Count”. These functionalities increase the applicability of i-87082 module. For more detail description, please refer to the following table.

i-87082 output data (1 Byte)

Bit	7	6	5	4	3	2	1	0
Func.	E-DO.1	E-DO.0	DO.1	DO.0	C1.S1	C1.S0	C0.S1	C0.S0

Func.	Meaning	Descriptions
E-DO.1	Enable DO.1	Enable=1, DO.1 is output. Enable=0, No output.
E-DO.0	Enable DO.0	Enable=1, DO.0 is output. Enable=0, No output.
DO.1	Digital Output CH1	Digital Output value of Channel 1.
DO.0	Digital Output CH0	Digital Output value of Channel 0.
C1.S1	Channel 1 Func.Sel. 1	Channel 1 Function Selection.
C1.S0	Channel 1 Func.Sel. 0	See table below.
C0.S1	Channel 0 Func.Sel. 1	Channel 0 Function Selection.
C0.S0	Channel 0 Func.Sel. 0	See table below.

Func.S1	Func.S0	Function
0	0	No Action(Disable)
0	1	Stop counting
1	0	Start counting
1	1	Clear count

Statistic Table of i-8K & i-87K

The following table shows the memory allocation of standard I/O and Counter / Frequency module, and we divide this table into four parts: The first table describes each function's meaning. The second table shows the input allocation of standard I/O, the third table shows the output allocation of standard I/O and the last part shows the Input/Output memory allocation of the Counter/Frequency module. We have simplified the following tables. The remainders of the table must be deduced by users.

Function Description Table

Function Name	Meaning
D _{a~b}	Digital I/O Value(bit a~b)
A.N _{a~b}	Analog Value of Channel N(bit a~b)
C.N _{a~b}	Count Value of Channel N(bit a~b)
CJC _{a~b}	CJC Temperature(bit a~b)
Clr _{a~b}	Clear Command(bit a~b)
OvN _{a~b}	Overflow Indicator(bit a~b)

Standard I/O – input memory allocation

Meas.Type	DI		DI w/ Count		AI		AI w/ CJC.read	
	Big	Little	Big	Little	Big	Little	Big	Little
BYTE.0	D _{24~31}	D _{0~7}	D _{24~31}	D _{0~7}	A.0 _{8~15}	A.0 _{0~7}	A.0 _{8~15}	A.0 _{0~7}
BYTE.1	D _{16~23}	D _{8~15}	D _{16~23}	D _{8~15}	A.0 _{0~7}	A.0 _{8~15}	A.0 _{0~7}	A.0 _{8~15}
BYTE.2	D _{8~15}	D _{16~23}	D _{8~15}	D _{16~23}	A.1 _{8~15}	A.1 _{0~7}	A.1 _{8~15}	A.1 _{0~7}
BYTE.3	D _{0~7}	D _{24~31}	D _{0~7}	D _{24~31}	A.1 _{0~7}	A.1 _{8~15}	A.1 _{0~7}	A.1 _{8~15}
BYTE.4			C.0 _{8~15}	C.0 _{0~7}	A.2 _{8~15}	A.2 _{0~7}	A.2 _{8~15}	A.2 _{0~7}
BYTE.5			C.0 _{0~7}	C.0 _{8~15}	A.2 _{0~7}	A.2 _{8~15}	A.2 _{0~7}	A.2 _{8~15}
BYTE.6			C.1 _{8~15}	C.1 _{0~7}	A.3 _{8~15}	A.3 _{0~7}	A.3 _{8~15}	A.3 _{0~7}
BYTE.7			C.1 _{0~7}	C.1 _{8~15}	A.3 _{0~7}	A.3 _{8~15}	A.3 _{0~7}	A.3 _{8~15}
BYTE.8			C.2 _{8~15}	C.2 _{0~7}	A.4 _{8~15}	A.4 _{0~7}	A.4 _{8~15}	A.4 _{0~7}
BYTE.9			C.2 _{0~7}	C.2 _{8~15}	A.4 _{0~7}	A.4 _{8~15}	A.4 _{0~7}	A.4 _{8~15}
BYTE.10			C.3 _{8~15}	C.3 _{0~7}	A.5 _{8~15}	A.5 _{0~7}	A.5 _{8~15}	A.5 _{0~7}
BYTE.11			C.3 _{0~7}	C.3 _{8~15}	A.5 _{0~7}	A.5 _{8~15}	A.5 _{0~7}	A.5 _{8~15}
BYTE.12			C.4 _{8~15}	C.4 _{0~7}	A.6 _{8~15}	A.6 _{0~7}	A.6 _{8~15}	A.6 _{0~7}
BYTE.13			C.4 _{0~7}	C.4 _{8~15}	A.6 _{0~7}	A.6 _{8~15}	A.6 _{0~7}	A.6 _{8~15}
BYTE.14			C.5 _{8~15}	C.5 _{0~7}	A.7 _{8~15}	A.7 _{0~7}	A.7 _{8~15}	A.7 _{0~7}
BYTE.15			C.5 _{0~7}	C.5 _{8~15}	A.7 _{0~7}	A.7 _{8~15}	A.7 _{0~7}	A.7 _{8~15}
BYTE.16			C.6 _{8~15}	C.6 _{0~7}			CJC _{8~15}	CJC _{0~7}
BYTE.17			C.6 _{0~7}	C.6 _{8~15}			CJC _{0~7}	CJC _{8~15}

Standard I/O – output memory allocation

Meas.Type	DO		DI w/ Count		AO		AI w/ CJC.offset	
	Big	Little	Big	Little	Big	Little	Big	Little
BYTE.0	D _{24~31}	D _{0~7}	clr _{24~31}	clr _{0~7}	A.0 _{8~15}	A.0 _{0~7}	ChnSel	offset _{7~0}
BYTE.1	D _{16~23}	D _{8~15}	clr _{16~23}	clr _{8~15}	A.0 _{0~7}	A.0 _{8~15}	Ena& offset _{8~15}	Ena& offset _{8~15}
BYTE.2	D _{8~15}	D _{16~23}	clr _{8~15}	clr _{16~23}	A.1 _{8~15}	A.1 _{0~7}	offset _{7~0}	ChnSel
BYTE.3	D _{0~7}	D _{24~31}	clr _{0~7}	clr _{24~31}	A.1 _{0~7}	A.1 _{8~15}		
BYTE.4					A.2 _{8~15}	A.2 _{0~7}		
BYTE.5					A.2 _{0~7}	A.2 _{8~15}		
BYTE.6					A.3 _{8~15}	A.3 _{0~7}		
BYTE.7					A.3 _{0~7}	A.3 _{8~15}		
BYTE.8					A.4 _{8~15}	A.4 _{0~7}		
BYTE.9					A.4 _{0~7}	A.4 _{8~15}		
BYTE.10					A.5 _{8~15}	A.5 _{0~7}		
BYTE.11					A.5 _{0~7}	A.5 _{8~15}		

Counter/Frequency memory allocation

Meas.Type	i-8080.Inp.		i-8080.Outp.		i-87082.Inp		i-87082.Outp	
	Big	Little	Big	Little	Big	Little	Big	Little
BYTE.0	C0 _{24~31}	C0 _{0~7}	Clr _{0~7}	Clr _{0~7}	C0 _{24~31}	C0 _{0~7}	E-DO.1 /E-DO.2 /DO.1 /DO.0 /C1.S1 /C1.S0 /C0.S1 /C0.S0	E-DO.1 /E-DO.2 /DO.1 /DO.0 /C1.S1 /C1.S0 /C0.S1 /C0.S0
BYTE.1	C0 _{16~23}	C0 _{8~15}			C0 _{16~23}	C0 _{8~15}		
BYTE.2	C0 _{8~15}	C0 _{16~23}			C0 _{8~15}	C0 _{16~23}		
BYTE.3	C0 _{0~7}	C0 _{24~31}			C0 _{0~7}	C0 _{24~31}		
BYTE.4	Ov0 _{8~15}	Ov0 _{0~7}			C1 _{24~31}	C1 _{0~7}		
BYTE.5	Ov0 _{0~7}	Ov0 _{8~15}			C1 _{16~23}	C1 _{8~15}		
BYTE.6	C1 _{24~31}	C1 _{0~7}			C1 _{8~15}	C1 _{16~23}		
BYTE.7	C1 _{16~23}	C1 _{8~15}			C1 _{0~7}	C1 _{24~31}		
BYTE.8	C1 _{8~15}	C1 _{16~23}			Ov0 _{0~1}	Ov0 _{0~1}		
BYTE.9	C1 _{0~7}	C1 _{24~31}						
BYTE.10	Ov1 _{8~15}	Ov1 _{0~7}						
BYTE.11	Ov1 _{0~7}	Ov1 _{8~15}						
BYTE.12	C2 _{24~31}	C2 _{0~7}						
BYTE.13	C2 _{16~23}	C2 _{8~15}						
BYTE.14	C2 _{8~15}	C2 _{16~23}						
BYTE.15	C2 _{0~7}	C2 _{24~31}						
BYTE.16	Ov2 _{8~15}	Ov2 _{0~7}						
BYTE.17	Ov2 _{0~7}	Ov2 _{8~15}						

The following figures describe the state flow of data exchange. The first figure shows the state flow of data exchange. There are four modules (i-87018Z, i-87024, i-87017W and i-87082) plugged in PROFI-8x55.

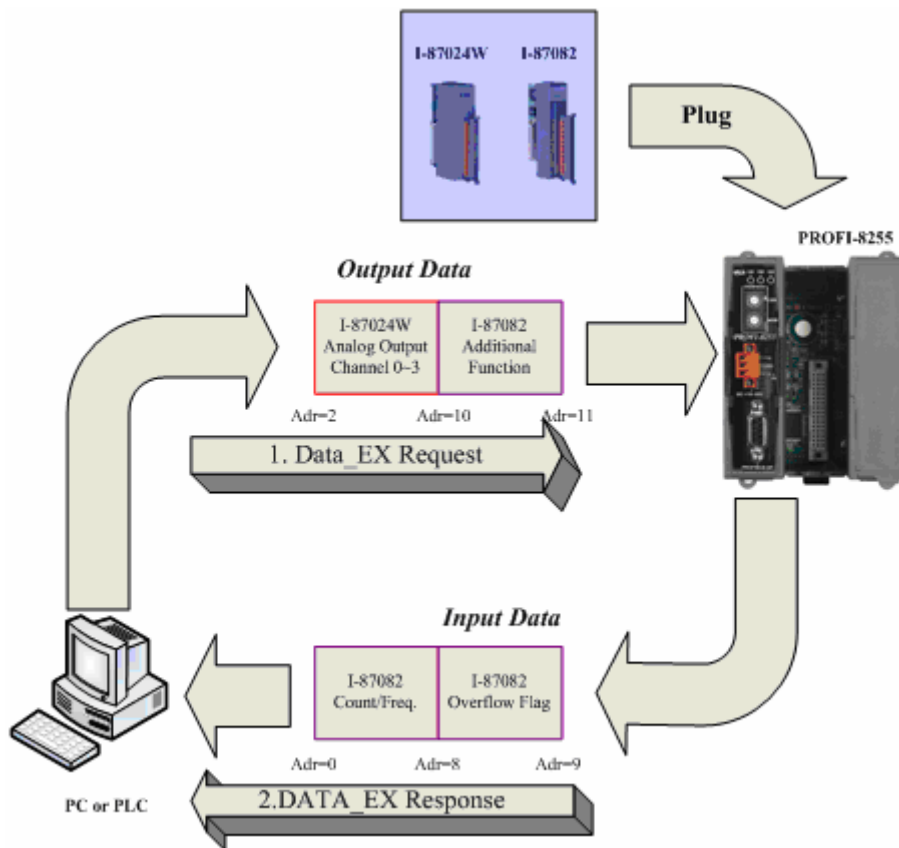

The second figure shows another state flow of data exchange. There is no output module that installation in PROFI-8x55 and only input module install.

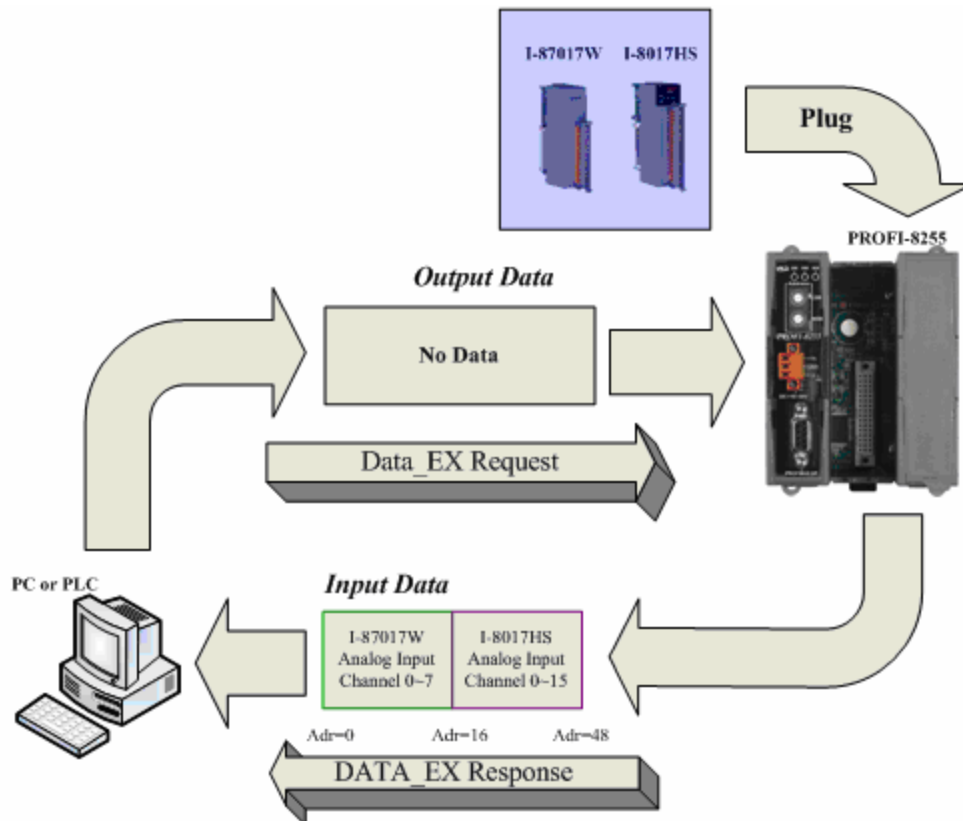

3.6. Diagnostic Message Report

The diagnostic messages report to DP-Master when the DP-Slave has errors or the unusual event occurs. Usually, It report diagnosis due to following standard channel-related event. Error code "2","3","5","6","7" and "8" are supported by PROFI-8x55.

Error Code	Error Type
0	Reserved
1	Short Circuit
2	Under-voltage
3	Over-voltage
4	overload
5	Over-temperature
6	Line/wire Break(Sensor Only)
7	Upper Limit Value Exceeded(Current)
8	Lower Limit Value Exceeded(Current, Sensor)
9	Error
10~15	Reserved
16~31	Manufacture Specific/Device-Related

PROFI-8x55 provides diagnosis report for Analog I/O and Counter/Frequency module. In Analog I/O module, the reason of diagnosis reports is that the input/output/count exceeds the default maximum value/minimum value or temperature sensor line break. In Counter/Frequency modules (I-87082 only), it usually due to the count exceeds the setting of "Maximum Count of Counter N" that set by Set_Prm telegram.

In PROFI-8155/8255, the number of channel-related diagnostic message is limit to 32. The diagnostic messages large than 104 bytes (39 channel-related diagnoses) will be ignore.

The channel-related diagnosis has been described above. There is another kind of diagnosis provided by PROFI-8x55; it called device-related diagnosis. The device-related diagnosis in PROFI-8x55 is "Module Offline". When the module is unplugged or breakdown, PROFI-8x55 will report the error with device-related diagnosis. The error-ID and corresponding meaning is shown in following table.

Error ID	Meaning
1	Slot 0- Module Offline
2	Slot 1- Module Offline

Several offline modules can be detected at the same time. PROFI-8155/8255 combines these Error-IDs into one byte and return to DP-Master once. For example, we know that all the modules in PROFI-8x55 disconnect (offline) when DP-Master gets a device-related diagnosis with error code "3". There are two examples that describe different error or warning event as follows. The first example is about that the I-87082 module unplugged and the diagnostic message reports. The following figure can shows the report process.

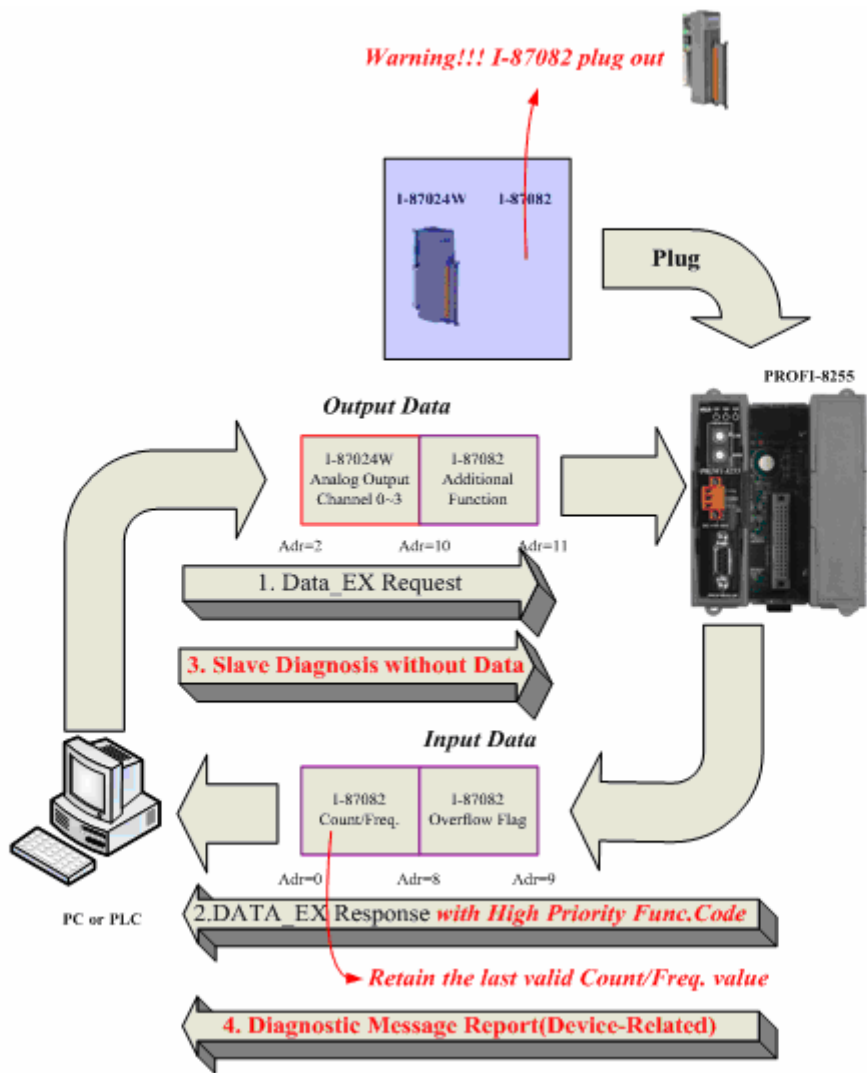

The second example is about the input value of channel 0 of I-8017W is larger than threshold value, and the diagnostic message reports. The following figure can shows the report process.

Warning!!! Input value of channel 0 is larger than threshold

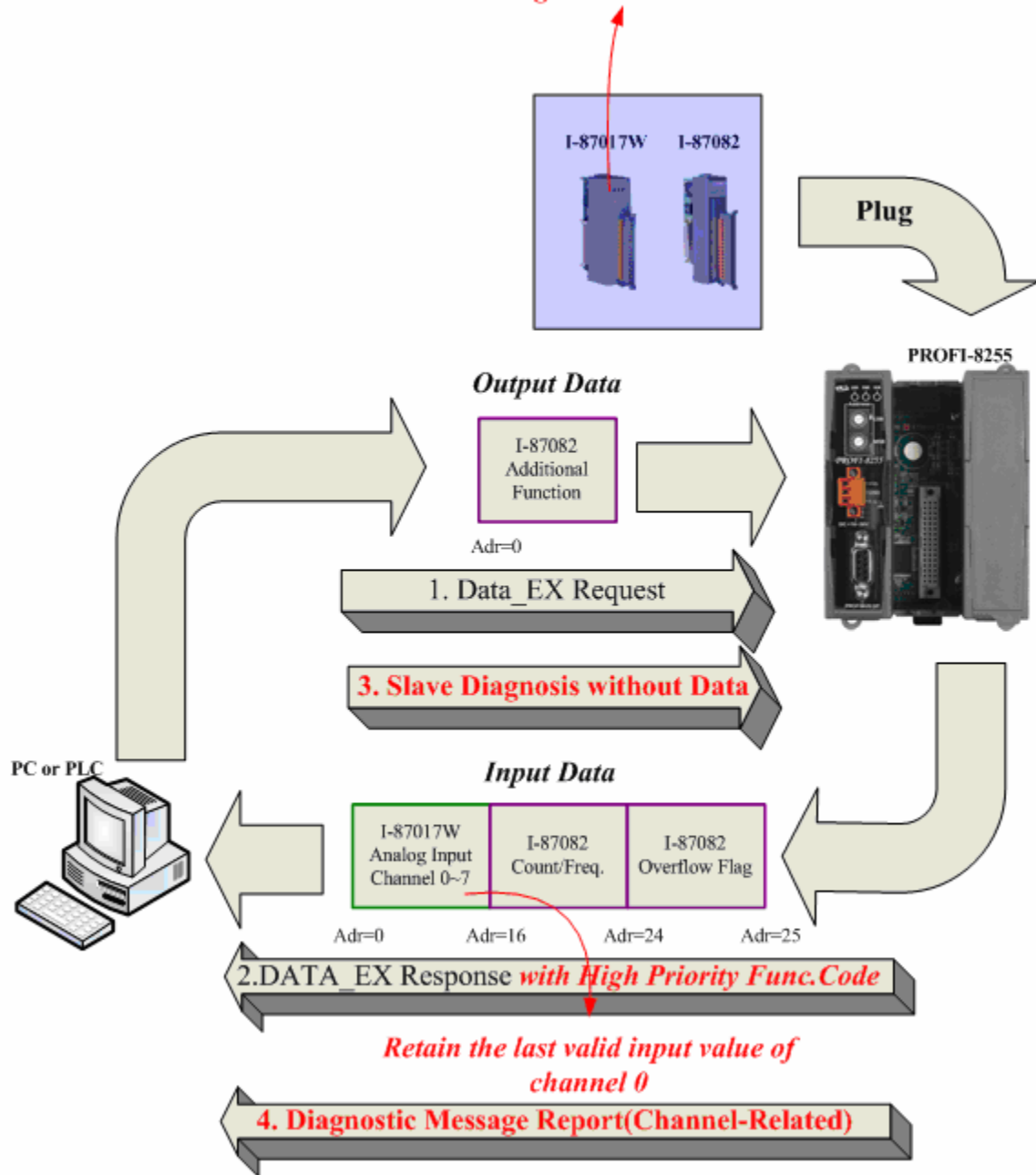

3.7. DP-V1 Acyclic Service

DP-V1 is the extension of DP-V0, it extends the original cyclic data exchange to acyclic one. Traditional data-exchange exploits default SAP for cyclic data-exchange. In DP-V1, Additional SAPs(49, 50, 51) for acyclic service, The SAP 49 is Resource Manager for manage each class 2 connection; The SAPs 50 and 51 are Read/Write/Alarm Ack access point for class 1 connection.

Class 1 Master is a device which cyclic data-exchange with DP-Slave. SAP 51 generally serve as Read/Write and Alarm Acknowledge, and SAP 50 optionally serve as Alarm Acknowledge for accelerate the reaction-time of Read/Write service. In case of frequent read/write service, alarm acknowledge must be independent from read/write service; In case of infrequent read/write, alarm acknowledge can shared SAP 51 with Read/Write.

DP-V1 slave provide a unique acyclic service entry SAP 49, this SAP called Resource Manager. Resource Manager play the role of coordinator, it coordinate multiple remote connection at one time. Before acyclic data-exchange, class 2 master send an initiate request to SAP49, then resource manager search for an available SAP(48~0) to response these information to Class 2 Master. After Class 2 Master receives initiate response, it applies the new SAP to request information you want. In contract to C1 Master, C2-Master supports Data-Transport service for read & write at one cycle. If DP-V1 services were no more need, Class 2 Master sent the Abort request to terminate the connection. During the connection, DP-Slave start watchdog timer to monitor the C2 DP-V1 telegram (C2-Init, C2-Abort, C2-Write, C2-Read, C2-DataTransport, C2-IDLE). If watchdog timer didn't clear by C2-IDLE, DP-slave will terminate this connection automatically.

The Information in DP-V1 is addressing by Slot and Index, Length is used to indicate the read/write length. Length in Write must be match with specification in DP-Slave, otherwise it will return "Invalid length". The information addressing use non-exist slot or index, it will return "Invalid slot" or "Invalid Index", for details, please refer to DP-Extension Specification.

DP-V1 services supported by PROFI-8155/8255 are Read and Write service, Alarm_Ack and Data_Transport didn't supported. List shown below is the Service-Index mapping table.

Slot ID	Index ID	R/W Feature	Addressing Information
0	0	R	Device Identifier
	1	R	Device Name
	2	R	Device Firmware Version
	3	R	Common Parameter(Byte Order)
1~2	4	R	The Number of Installed Module
	1	R	Module Name
	2	R(i-87K)	Module Firmware Version
	3	R	I/OType
	4	R	Input Data Length
	5	R	Output Data Length
	6	R	Data Format
	7	R	Operation Mode(Type-Code)
	8~15	N/A	Reserved
	16	R	Input Data of All Channel
	17	R	Input Data of Status (CJC's Temp.,DI's Count)
	18	R	Output Data of All Channel
	19	R	Output Data of Control (DI w/ Cnt Clear, CJC Compens., i-87082,i-8080 Clear Command)
	20~31	N/A	Reserved
	32	R	Digital Input or Analog Input of Channel 0
33~63	R	Analog Input of Channel 1 ~ 31	
64	R	Digital Ouput or Analog Output of Channel 0	
65~95	R	Analog Output of Channel 1 ~ 31	
96	R(i-87K)	Digital Safe-Value Analog Safe-Value of Channel 0	
97~127	R(i-87K)	Analog Safe-Value of Channel 1~31	
128	R/W(i-87K)	Digital Power-On Value Analog Power-On Value of Channel 0	
129~159	R/W(i-87K)	Analog Power-On Value of Channel 1~31	
128~133	0~255	R/W	Read/Write EEPROM(Block 0~5)
134~135	0~255	R	Read EEPROM (Block 6~7)

Slot 0 represent the main control unit of PROFI-8155/8255, Slot 1~2 represent the I/O module in expansion slots. If user access the Slot that

module not support or not installed, the PROFI-8155/8255 report “Invalid Slot” to user.

Device identifier is the series-number that device register to PNO, it is unique and only available on PROFI-8155/8255.

Device name is PROFI-8155 if the device has one expansion slot, and device name is PROFI-8255 if the device has two expansion slots.

Device firmware version is 1.00 at release, and 1.01, 1.02, etc. at revision.

Following information are only available in Slot 1/2. Module Name is the format of 870xx or 80xx. Module firmware version is only available in i-87K Module. The firmware version is the format of Ax.xx or Bx.xx.

I/O type classified i-8K and i-87K module into 5 categories, shown below

I/O Type	Digital Inp.	Digital Outp.	Analog Inp.	Analog Outp.	Cnt&Freq
Type ID	1	2	4	8	16

Input/Output Data Length is the length of memory space allocated to expansion modules. It excludes the length of the fields of CJC Read/Write and i-87K DI Clear command.

Data format totally classified into 4 categories, they are Engineering-Units, Percentage of Full Scale, Hexadecimal format, Ohm Unit(RTD, Thermister only). Details described follow

Data Format	Engineering(0)	% of F.S.(1)	Hex(2)	Ohm(3)
i-8K	■		■	
i-87K	■	■	■	■

Note: ■ represent supported.

The operation mode of i-87K modules that called type code in website refers to ICP DAS’s Product website. For i-8K modules, the operation mode show below

i-8024 Operation Mode

Operation Mode	0	1	2
Operation Range	$\pm 10V$	0~20mA	0~20000uA (Engineer only)

i-8017H(S) Operation Mode

Operation Mode	0	1	2	3	4
Operation Range	$\pm 10V$	$\pm 5V$	$\pm 2.5V$	$\pm 1.25V$	$\pm 20mA$

i-8080 Operation Mode

Operation Mode	0	1	2	3
Operation Type	Dir/Pulse (4Ch)	Up/Down (4Ch)	Frequency (8Ch)	Up (8Ch)

Index large than 32 was used to indexing general-purpose I/O related information. Any Class 2 DP-Master can access the I/O data using these indices by MSAC2 telegram. Beside the Power-On Value, all the others were read only.

Index from 32 to 63 mapped the Input data from the corresponding module to the DP-V1 buffer. Data Address and Byte Order obey the DP-V0 setting, beside the special status signal.

i-87018(R/W/Z) as well as i-87019R both provide the function of CJC temperature reading. In order to indexing this information, the index of CJC temperature is 40 in i-87018-series module, and the index is 42 in i-87019R module.

i-87K digital input modules contain a low-frequency(100Hz) counter for each channel. For access these counter, user just accesses the index that equal to 32 plus desired channel number.

Index from 64 to 95 mapped the output data from the corresponding module to the DP-V1 buffer. Data Address and Byte Order obey the DP-V0 setting, beside the special control signal.

“Counter Clear” is an output for i-8080, this information can access by Index 64. “Counter Start/Stop/Clear” as well as “2 Bit’s Digital Output” were combine into one byte in 87082(W), this information can access by Index 64. i-87K Digital Input Module with Counter functionality also have “Counter Clear”

command that access by index 64(Pure Input Module) or index 65(Input/Output module). i-87K module that support thermocouple Input provide CJC temperature calibration that can be access by Index 64.

Safe Value of i-87K output module only support DP-V1 read service. Write service is forbiddance, because of safe-value setting of parameter data. The safe-value of analog module or digital module can be access by index 96 to index 127. Notice that i-87082(W) 2 bits' output not supported safe-value output.

Power-On Value is a mechanism that prevents non-regular operation that DP-Slave just Power-On and not in Data-Exchange procedure. Power-On Value valid for the interval of Data-Exchange before and Power-On after. This information can be access by index 128~160.

Slot from 128 to 137 is used for access the EEPROM of PROFI-8155/8255. There is 2 kilo-byte memory space, 256 byte reserved for OS, 256 byte used to store PROFI-8x55 setting, the remainder 1.5Kbyte can be read/write by user. The upper 512Byte mentioned above only supported DP-V1 read service. The maximum length of each accessing limit to 64 byte, and read service can cross different block, but write service can't.

3.8. Establish connection with PROFI-8X55

Before establish the connection between DP-Master and PROFI-8x55, user should conform to the following step first.

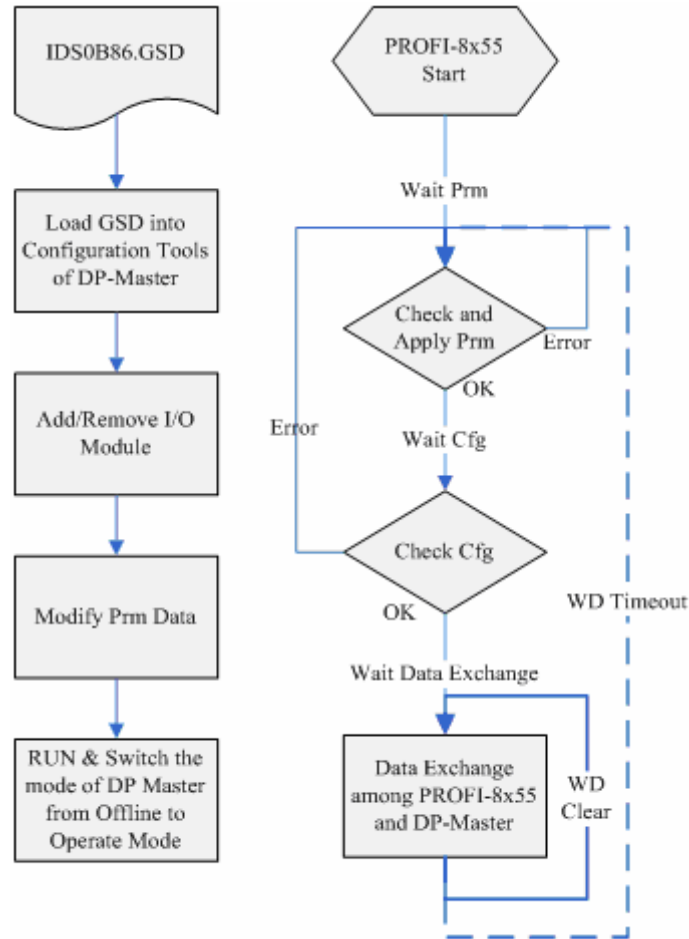

First, users must load the electronic device description file (GSD file) of the PROFI-8x55 into the DP-Master, and then set the parameters of the modules plugged in PROFI-8x55 respectively. Finally change your DP-master from Offline state to Operate state. While DP-Master changes to operate mode, PROFI-8x55 will initial the modules. Then PROFI-8x55 allocates the memory space and waits for Set_Prm telegram. The next stage is waiting for Chk_Cfg telegram in order. If there is no error occurs, PROFI-8x55 proceeds into data exchange state. Users can observe the status indicator LED to know the state of PROFI-8x55. At the meantime, if there is any error occurs, PROFI-8x55 will return to wait parameterization.

3.9. Telegram cycle of data exchange

If you want to know the round-trip time of a data exchange telegram, you must know how a byte enveloped into a serial stream. In series communication, the byte transmission includes start bit, stop bit, data field and optional parity. According to the PROFIBUS specification, there is no parity bit in transmission. Therefore, one data byte will be encoded to 11 bits. Consequently, the telegram cycle time of data exchange will calculate as follow.

$$T = (\text{Output data Bit Time (header include)} + \text{Station Reaction Bit Time} + \text{Input Data Bit Time (header include)} + \text{Bus Idle Bit Time} + \text{Sync-Bit Time}) * \text{Transmission Time per Bit.}$$

$$\text{Output Data Bit Time (header include)} = (9 + \text{length of output data in Byte}) * 11$$

Station Reaction Time = Any Value that large than Min.Tsdr and smaller than Max.Tsdr

There is look up table between Baud Rate and Max.Tsdr. (This information is in GSD file)

Baud Rate(in bit per second)	Max.Tsdr (in Tbit)
9600	60
19,200	60
454,500	60
937,500	60
187,500	60
500,000	100
1,500,000	150
3,000,000	250
6,000,000	450
12,000,000	800

$$\text{Input Data Bit Time (header include)} = (9 + \text{length of input data in Byte}) * 11$$

$$\text{Bus Idle Time} = \max (T_{\text{SYN}} + T_{\text{SM}} , \min T_{\text{SDR}} , T_{\text{SDI}})$$

For details, please refer to PROFIBUS Specification.

Sync. Bit Time = 33 (constant)

Transmission Time per Bit = the inverse of Baud Rate.

For example:

The data transmission time with 15 bytes output data and 30 bytes input data in 12Mbps is calculated as follows.

Parameter : $T_{\text{SYN}}=33$ Tbits

$T_{\text{ID1}}=75$ Tbits (1.5M BR)

$T_{\text{SDR}}=30$ Tbits (1.5M BR)

Min_Slave_Interval = 1

The time is as follows.

$$T = ((9+15) * 11 + 30 + (9+30) * 11 + 33 + 75) / 12 * 10^6 = 69.25\mu\text{S}$$

4. PROFI-8X55 Guideline (Based on Step 7)

In this chapter, we make a demo with PROFI-8X55 and the DP-Master of Siemens S7-300. The demo is shown how to apply the PROFI-8X55 in a realistic system.

4.1. Preprocessing

1. Insert New Object->PROFIBUS:

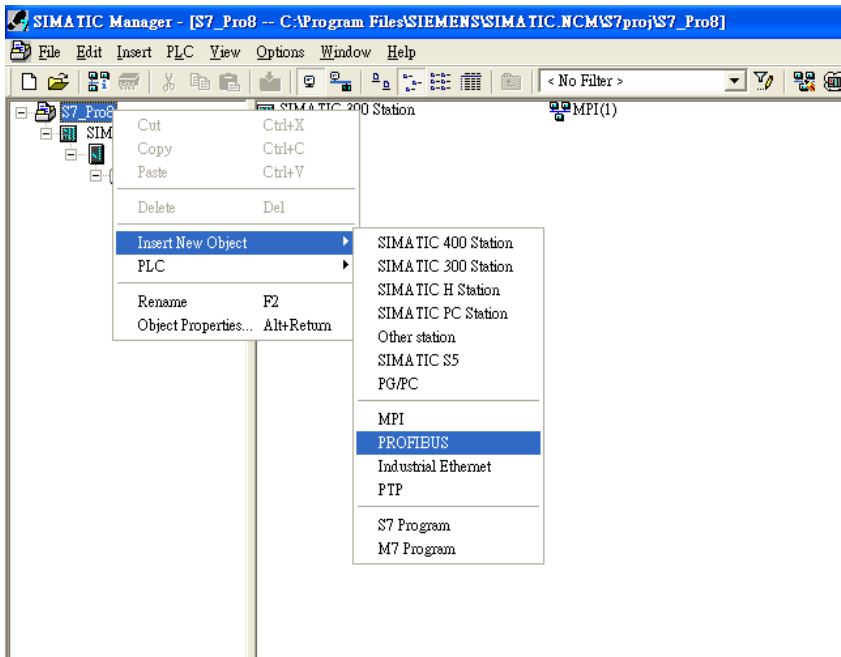

2. Enter Hardware Configuration: Double-Click SIMATIC 300 Station->Hardware

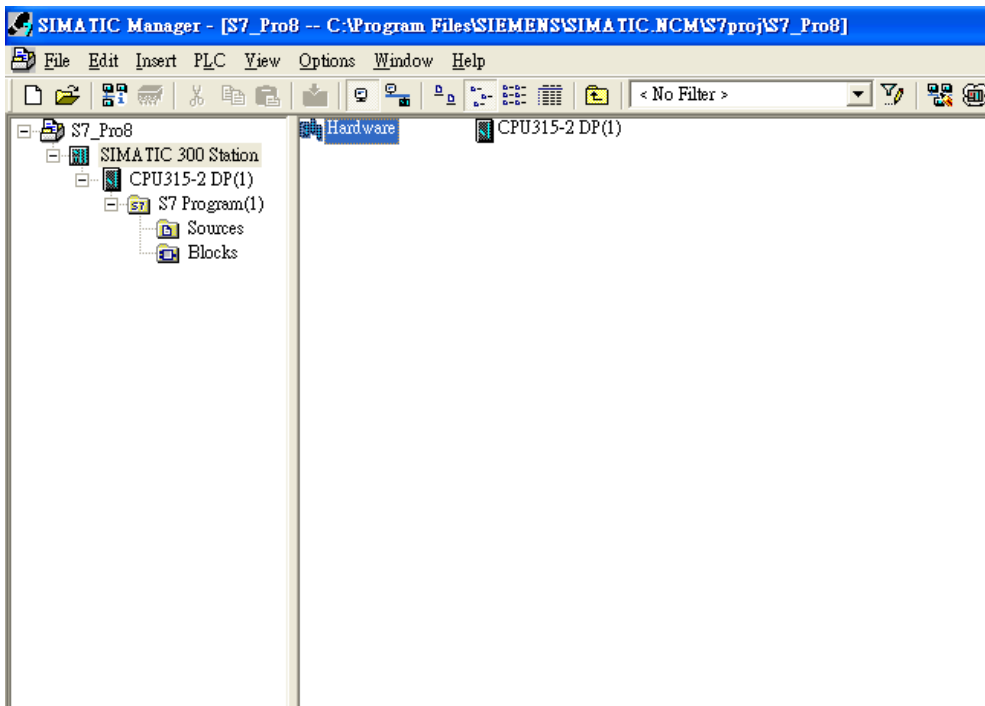

3. Add DP-Master to PROFIBUS network:
 Right-Click “DP”, Select “ Add Master System” and Modify Network
 Parameter.

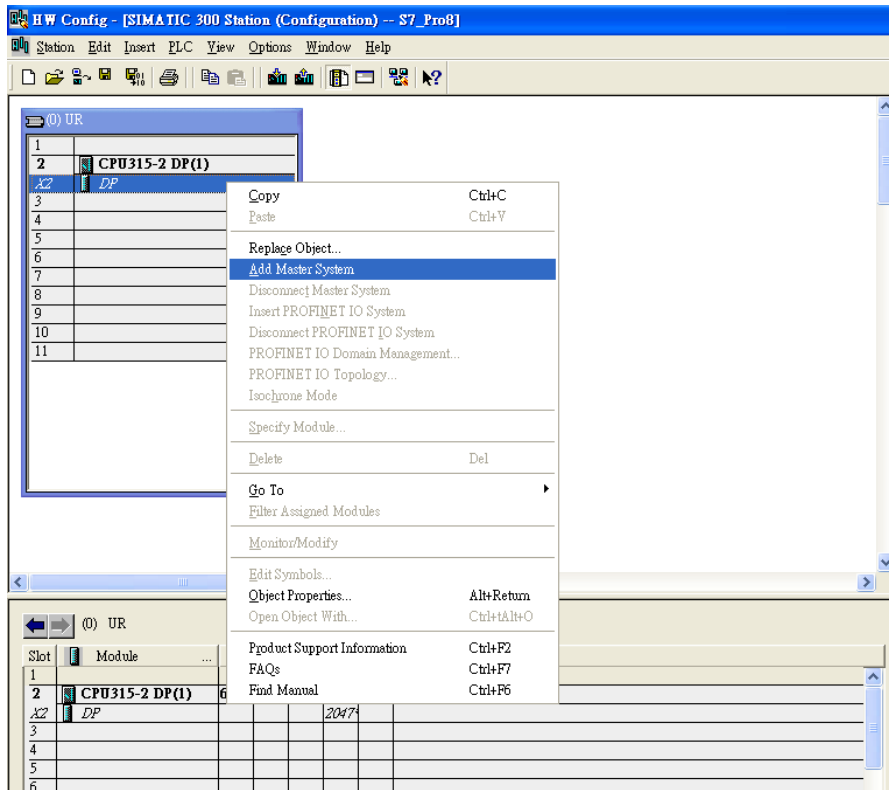

4. Add GSD into Step7:
 Select “Options”->”Install GSD file”, then located & Install GSD file.

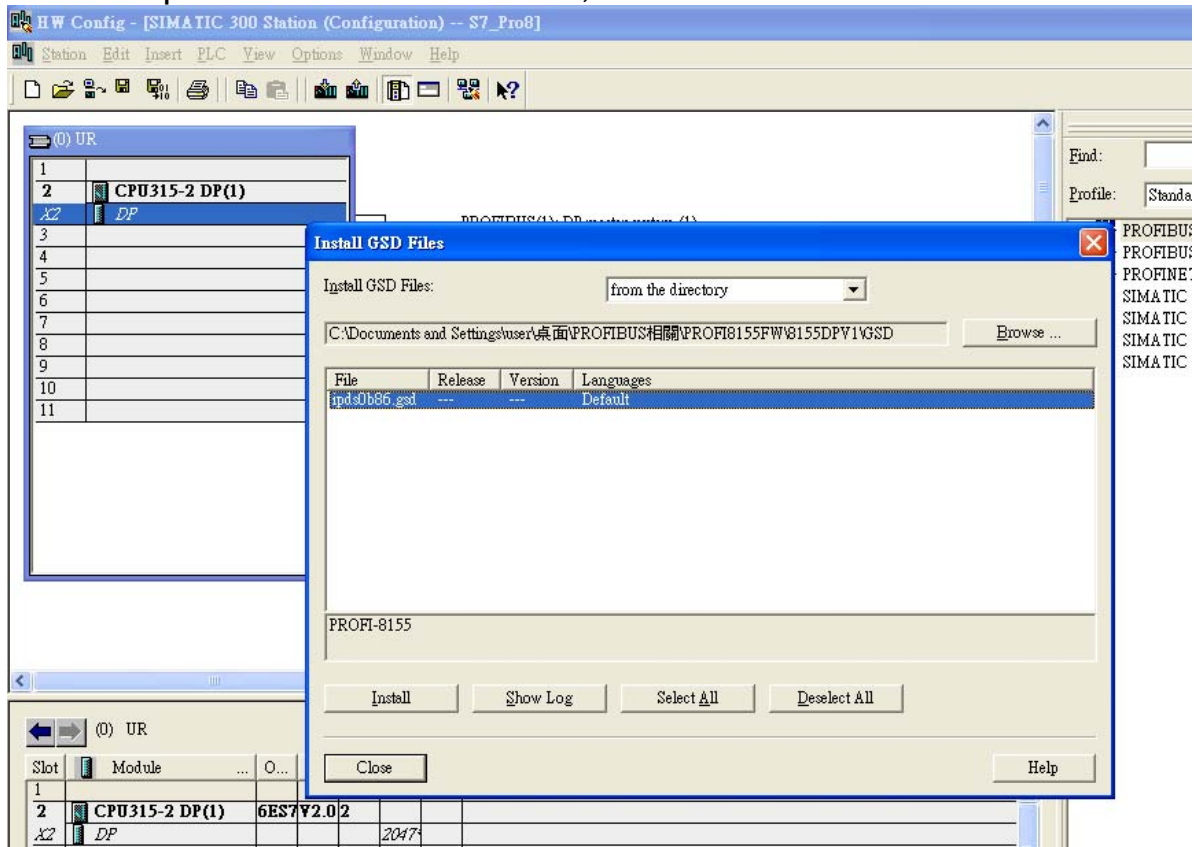

5. Add Module into PROFI-8155/8255:

1. Add module(s):

Add the module(s) you want to use. In this example, we choose i-8017H and i-8024.

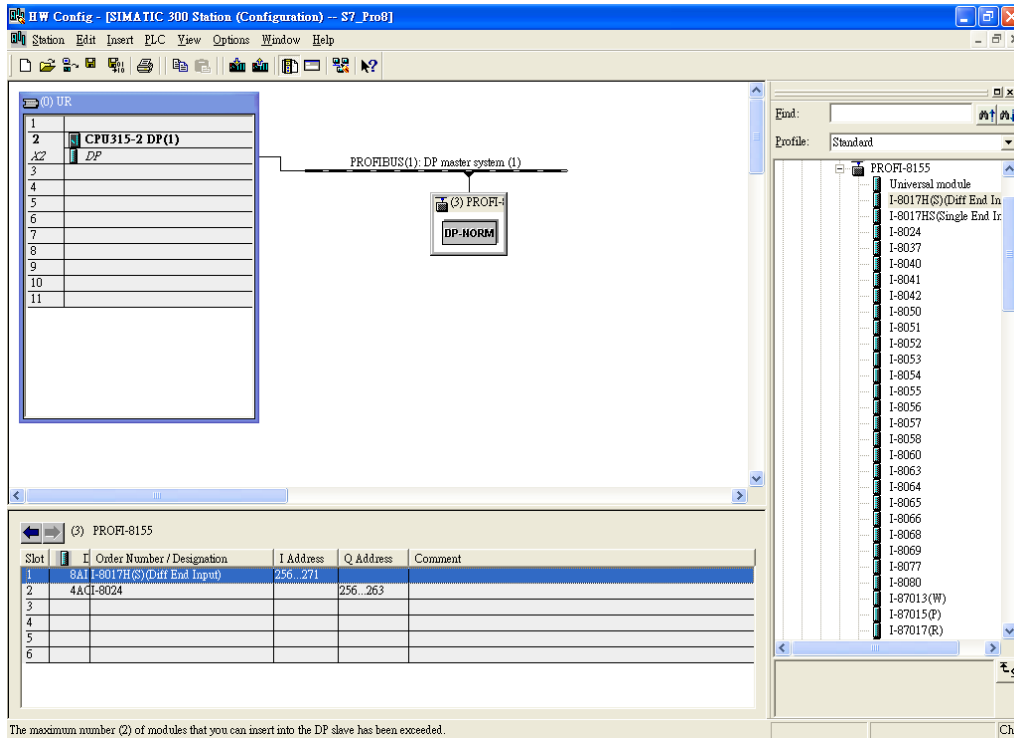

Slot	Order Number / Designation	I Address	Q Address	Comment
1	8AI I-8017H(S)(Diff End Input)	256..271		
2	4AI I-8024		256..263	
3				
4				
5				
6				

The maximum number (2) of modules that you can insert into the DP slave has been exceeded.

2. Modify parameter data :

Click <Parameter Data> button in right-up corner of the windows, and modify the “Common” and “Module” parameter by your preference. In this example, we use default setting.

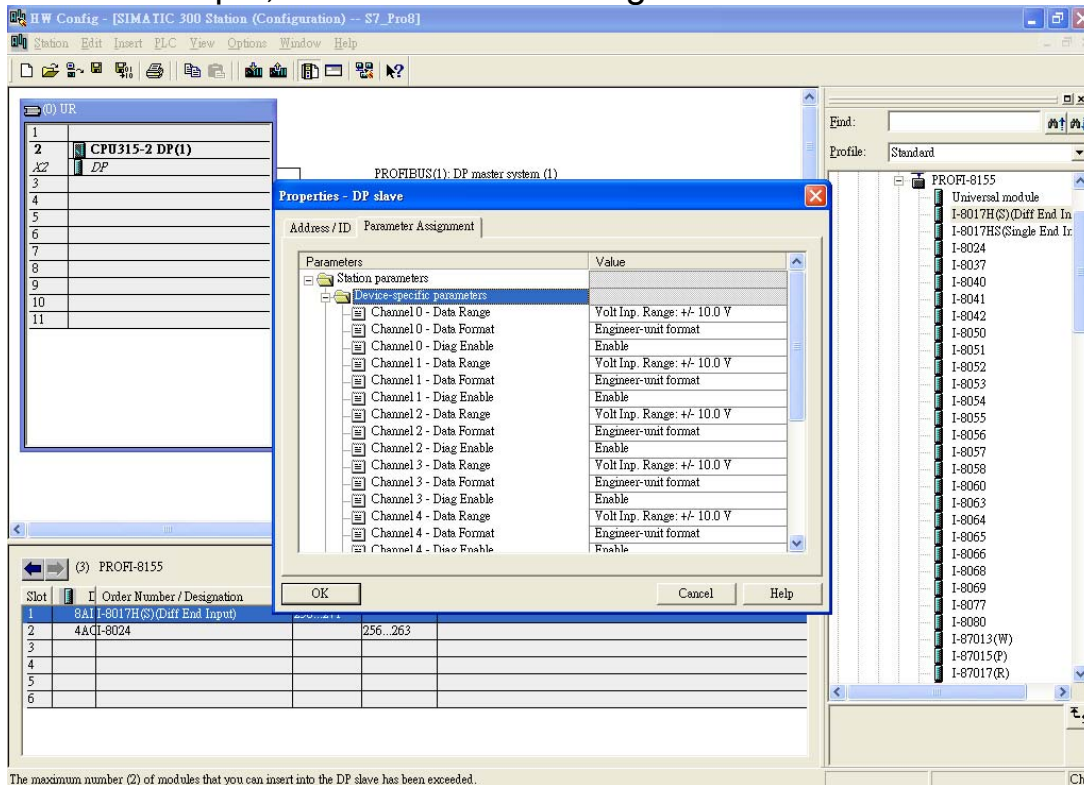

Parameters	Value
Station parameters	
Device-specific parameters	
Channel 0 - Data Range	Volt Inp. Range: +/- 10.0 V
Channel 0 - Data Format	Engineer-unit format
Channel 0 - Diag Enable	Enable
Channel 1 - Data Range	Volt Inp. Range: +/- 10.0 V
Channel 1 - Data Format	Engineer-unit format
Channel 1 - Diag Enable	Enable
Channel 2 - Data Range	Volt Inp. Range: +/- 10.0 V
Channel 2 - Data Format	Engineer-unit format
Channel 2 - Diag Enable	Enable
Channel 3 - Data Range	Volt Inp. Range: +/- 10.0 V
Channel 3 - Data Format	Engineer-unit format
Channel 3 - Diag Enable	Enable
Channel 4 - Data Range	Volt Inp. Range: +/- 10.0 V
Channel 4 - Data Format	Engineer-unit format
Channel 4 - Diag Enable	Enable

The maximum number (2) of modules that you can insert into the DP slave has been exceeded.

-
6. Download the network configuration to DP-Master :
Click "PLC" -> "Download" to download the network setting into S7-300.

 7. Install Module(s):
In this example, we plug i-8017H and i-8024 into expansion slot in PROFI-8X55 in order.

 8. Adjust the rotary switches:
In previous step, we modify the address of DP-Slave to "1", so we must adjust the rotary switches to 01 on the panel of PROFI-8x55.

 9. Power supplied :
Plug the power terminator with 24VDC to PROFI-8X55.

5. GSD File

A GSD is a readable ASCII text file and contains both general and device-specific specifications for communication. Each of the entries describes a feature that is supported by a device. A GSD replaces the previously conventional manuals and supports automatic checks for input errors and data consistency, even during the configuration phase.

PROFI-8X55 GSD file is located at ICPDAS Product CD and the following web site

ftp://ftp.icpdas.com.tw/pub/cd/fieldbus_cd/profibus/remote%20io/profi-8155/gsd/