

tM-752N Series User Manual

Tiny Addressable Serial Converter

Ver. 1.1.1/ Aug. 2014



SUPPORTS

Module includes tM-7521 and tM-7522.

WARRANTY

All products manufactured by ICP DAS are warranted against defective materials for a period of one year from the date of delivery to the original purchaser.

WARNING

ICP DAS assumes no liability for damages consequent to the use of this product. ICP DAS reserves the right to change this manual at any time without notice. The information furnished by ICP DAS is believed to be accurate and reliable. However, no responsibility is assumed by ICP DAS for its use, nor for any infringements of patents or other rights of third parties resulting from its use.

COPYRIGHT

Copyright © 2013 by ICP DAS. All rights are reserved.

TRADEMARK

Names are used for identification only and may be registered trademarks of their respective companies.

CONTACT US

If you have any question, please feel to contact us. We will give you quick response within 2 workdays.

Email: service@icpdas.com, service.icpdas@gmail.com

TABLE OF CONTENTS

- PACKING LIST 4**
- MORE INFORMATION 4**
- 1. INTRODUCTION..... 5**
 - 1.1 ADDRESSABLE RS-232 CONVERTER..... 6
 - 1.2 RESPONSES FROM RS-232 DEVICES CAN BE ADDRESSABLE..... 6
 - 1.3 ONBOARD 1 KB QUEUE BUFFER 6
 - 1.4 WEB SERVER 7
- 2. HARDWARE INFORMATION 8**
 - 2.1 SPECIFICATIONS 8
 - 2.2 FEATURES..... 9
 - 2.3 SELECTION GUIDE 9
 - 2.4 FRONT VIEW 10
 - 2.5 DIMENSIONS 13
 - 2.6 PIN ASSIGNMENTS 14
 - 2.7 WIRING NOTES 15
- 3. SETTING UP THE TM-752N 16**
 - STEP 1: CONNECTING THE POWER AND HOST PC 16
 - STEP 2: RUN THE ESEARCH UTILITY 18
 - STEP 3: SEARCH FOR THE TM-752N MODULE 19
 - STEP 4: CONFIGURE THE NETWORK SETTINGS..... 19
 - STEP 5: TESTING YOUR TM-752N MODULE 20
- 4. WEB CONFIGURATION 22**
 - 4.1 LOGGING ON TO THE TM-752N WEB SERVER 22
 - 4.2 HOME PAGE 24
 - 4.3 NETWORK SETTING..... 25
 - 4.3.1 Network and Miscellaneous Settings..... 25
 - 4.3.2 IP Address Selection 25
 - 4.3.3 General Configuration Settings..... 28
 - 4.3.4 Restore Factory Defaults 29

4.4	SERIAL PORT SETTINGS.....	30
4.4.1	Port1 Settings	30
4.5	FILTER.....	32
4.5.1	Filter Settings.....	32
4.6	CHANGE PASSWORD.....	33
4.7	LOGOUT.....	33
5.	COMMAND SETS	34
5.1	COMMAND SETS TABLE.....	34
5.1.1	\$AAA[addr].....	35
5.1.2	\$AABN[baud rate]	36
5.1.3	\$AADN[data-bit].....	38
5.1.4	\$AAPN[parity-bit].....	40
5.1.5	\$AAON[stop-bit].....	42
5.1.6	\$AA6[name]	44
5.1.7	\$AA7.....	45
5.1.8	\$AAC[delimiter].....	46
5.1.9	[delimiter]AA[bypass].....	48
5.1.10	\$AAKV.....	49
5.1.11	\$AATN[CrLfmode].....	51
5.1.12	\$AAM.....	53
5.1.13	\$AAU.....	54
5.1.14	\$AAJN[timeout].....	56
5.1.15	\$AAEV.....	58
6.	TYPICAL APPLICATIONS	60
6.1	APPLICATION 1	60
6.2	APPLICATION 2	61
6.3	APPLICATION 3	62

PACKING LIST

The shipping package includes the following items:

- One tM-752N series hardware module
- One printed Quick Start Guide
- One DC Connector Power cable

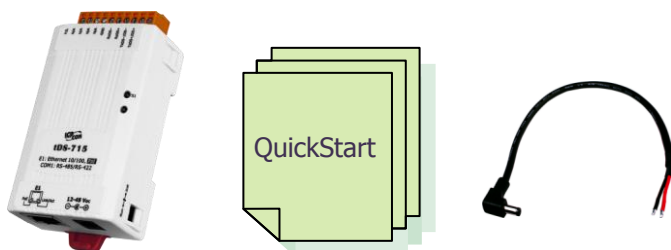

Note!!

If any of these items are missing or damaged, please contact the local distributor for more information. Save the shipping materials and cartons in case you want to ship the module in the future.

MORE INFORMATION

Documentation

<http://ftp.icpdas.com/pub/cd/tinymodules/napdos/tM-752N/document/>

Firmware

<http://ftp.icpdas.com/pub/cd/tinymodules/napdos/tM-752N/firmware/>

eSearch Utility

<http://ftp.icpdas.com/pub/cd/tinymodules/napdos/software/esearch/>

tM-752N Product Page

http://www.icpdas.com/root/product/solutions/industrial_communication/gateway/tm-752n.html

1. Introduction

Nowadays, a great number of RS-232 devices for both automation and information transfer are being used in industrial applications, and linking these devices is very important in the modern situation. The devices are usually located at a distance from the Host PC, meaning that linking via multiple serial cards is inefficient. ICPDAS tM-752N series products have been developed to provide an effective link between multiple RS-232 devices via a single RS-485 network. This network protocol offers stability, reliability and simple cabling while delivering a low-cost, easy-to-maintain product.

To achieve maximum space savings, the tM-752N is offered in an amazingly small form-factor that enables it to be easily installed anywhere, even directly attached to a serial device or embedded into a machine. The tM-752N features a powerful 32-bit MCU, offers true IEEE 802.3af-compliant (classification, Class 1) Power-over-Ethernet (PoE) functionality using a standard category 5 Ethernet cable that allows it to receive power from a PoE switch such as the NS-205PSE. If there is no PoE switch available on site, the tM-752N can accept power input from a DC adapter.



1.1 Addressable RS-232 Converter

Most RS-232 devices don't support individual device addressing. To overcome this limitation, ICPDAS tM-752N series modules assign a unique address to any RS-232 device installed on an RS-485 network. When the Host PC sends a command to the RS-485 network a device address can be attached to the command. The destination tM-752N module will then remove the address field and pass the remaining commands to the destination RS-232 device. Responses from the local RS-232 devices will be returned to the Host PC via the tM-752N module.

1.2 Self-Tuner ASIC Inside

The built-in Self-Tuner ASIC on an RS-485 port can automatically detect and control the send/receive direction of the RS-485 network. Consequently, there is no need for application programs to be concerned with direction control of the RS-485 network.

1.3 Onboard 1 KB Queue Buffer

tM-752N series modules are equipped with a 1KB queue buffer for its local serial port. All input data can be stored in the queue buffer until the Host PC has time to read it. These features allow the Host PC to be linked to thousands of RS-232 devices without any loss of data.

1.4 Web Server

Web server enables configuration of the tM-752N via a standard web browser interface, e.g. Internet Explorer, Firefox or Mozilla, etc. This means that it is easy to check the configuration of the tM-752N via web interface instead of using console commands, thereby reducing the user's learning curve.



tM-752N Series

[Home](#) | [Port1](#) | [Network Setting](#) | [Filter](#) | [Change Password](#) | [Logout](#)

Status & Configuration

Model Name:	tM-752N	Alias Name:	0457
Firmware Version:	v1.0.4 [Jul.13, 2012]	MAC Address:	00-0D-E0-80-00-36
IP Address:	10.0.8.100	System Address:	0x00 (0)
Initial Switch:	OFF	System Timeout: (Serial Watchdog, Seconds)	300

Current port settings:

Port Settings	Port 1
Baud Rate (bps):	115200
Data Size (bits):	8
Parity:	None
Stop Bits (bits):	1
Flow Control:	None
Serial Ending Chars:	-
Port ID:	0x00 (0)
Delimiter:	:
Response Timeout (ms):	1000
Continue Response Timeout (ms):	-

Copyright © 2009 ICP DAS Co., Ltd. All rights reserved

2. Hardware Information

2.1 Specifications

Model	tM-7521	tM-7522
System		
CPU	32-bit MCU	
Communication Interface		
Ethernet	10/100 Base-TX, 8-pin RJ-45 x 1, (Auto-negotiating, Auto-MDI/MDIX, LED indicator) PoE (IEEE 802.3af, Class 1)	
COM1	2-wire RS-485	2-wire RS-485
COM2	5-wire RS-232	3-wire RS-232
COM3	-	3-wire RS-232
Self-Tuner	Yes, automatic RS-485 direction control	
RS-485	Bias Resistor	Yes, 10 K Ω
	Node	32 (max.)
UART	16c550 or compatible	
COM Port Format		
Baud Rate	115200 bps Max.	
Data Bit	5, 6, 7, 8	
Parity	None, Odd, Even, Mark, Space	
Stop Bit	1, 2	
General		
Power Input	PoE: IEEE 802.3af, Class 1 DC jack: +12 ~ 48 V _{DC}	
Power Consumption	0.05 A @ 24 V _{DC}	
Connector	10-Pin Removable Terminal Block x 1	
Mounting	DIN-Rail	
Flammability	Fire Retardant Materials (UL94-V0 Level)	
Operating Temperature	-25° ~ 75°C	
Storage Temperature	-30° ~ 80°C	
Humidity	10 ~ 90% RH, non-condensing	

2.2 Features

- Built-in “Addressable RS-232 Converter” firmware
- Contains a powerful 32-bit MCU
- 10/100 Base-TX Ethernet, RJ-45 x1
(Auto-negotiating, auto MDI/MDIX, LED Indicators)
- Includes redundant power inputs: PoE (IEEE 802.3af, Class 1) and DC jack
- Allows automatic RS-485 direction control
- Supports UDP responder for device discovery
- Allows easy firmware update via the Ethernet
- Built-in Web server for easy configuration
- Terminal block connector for easy wiring
- Tiny form-factor and low power consumption
- RoHS compliant and no Halogen
- Made from high-grade fire-retardant materials (UL94-V0 Level)
- Cost-effective

2.3 Selection Guide

Model	CPU	Ethernet	Baud Rate	COM1	COM2	COM3
tM-7521	32-bit MCU	10/100 Base-TX, PoE	115200 bps	2-wire RS-485	5-wire RS-232	-
tM-7522				2-wire RS-485	3-wire RS-232	3-wire RS-232
3-Wire RS-232: RxD, TxD, GND (Non-isolated) 5-Wire RS-232: RxD, TxD, CTS, RTS, GND (No-isolated) 2-Wire RS-485: DATA+, DATA-, GND (Non-isolated)						

2.4 Front View

Here is a brief overview of the tM-752N series module components and a description.

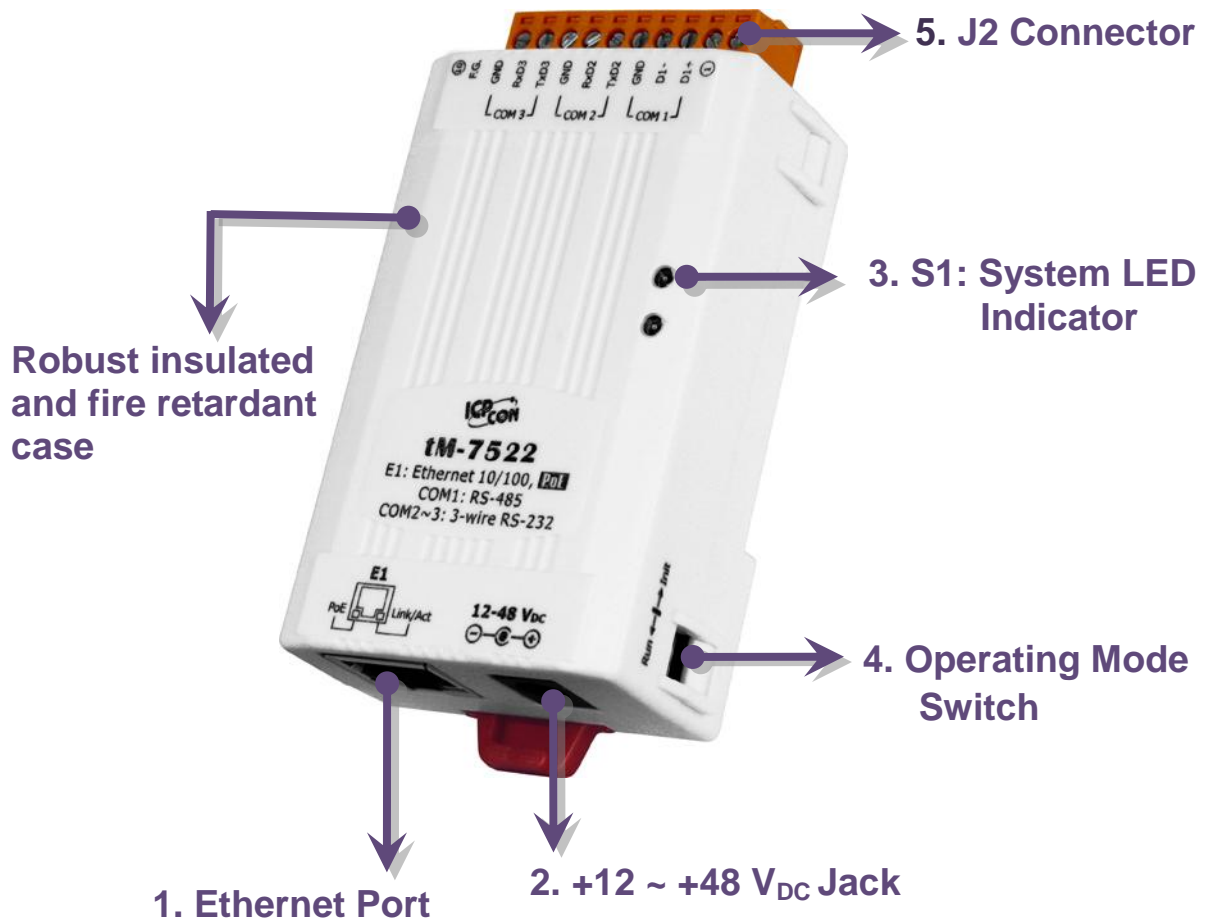

1. PoE and Ethernet RJ-45 Jack:

The tM-752N is equipped with a RJ-45 jack that is used as the 10/100 Base-TX Ethernet port and features networking capability. When an Ethernet link is detected and an Ethernet packet is received, the **Link/Act LED (Orange)** indicator will be illuminated. When power is supplied via PoE (Power-over-Ethernet), the **PoE LED (Green)** indicator will be illuminated.

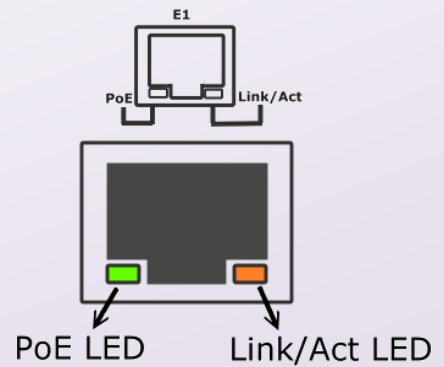

2. +12 V_{DC} ~ +48 V_{DC} Jack:

The tM-752N is equipped with a +12 ~ +48 V_{DC} jack that is used as the power supply. If there is no PoE switch available on site, the tM-752N will accept power input from a DC adapter.

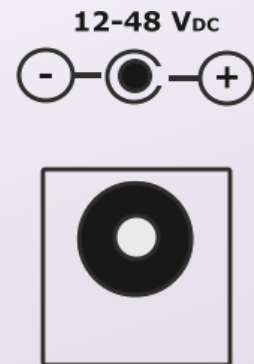

3. S1: System LED Indicator:

Once power is supplied to the tM-752N, the system LED indicator will be illuminated as follows:

Function	System LED Behavior
Running Firmware	ON
Network Ready	Flashing per 3seconds
Serial Port busy	Flashing per 0.2 seconds

4. Operating Mode Switch:

Init Mode: Uses factory settings and allows firmware update.

Run Mode: Uses customer settings.

In the tM-752N series, the operating mode Switch is in the Run position by default. When updating the tM-752N firmware, the switch needs to be moved from the Run position to the Init position. The Switch must be returned to the Run position after the update is complete.

 **Note: Requires reboot after change mode.**

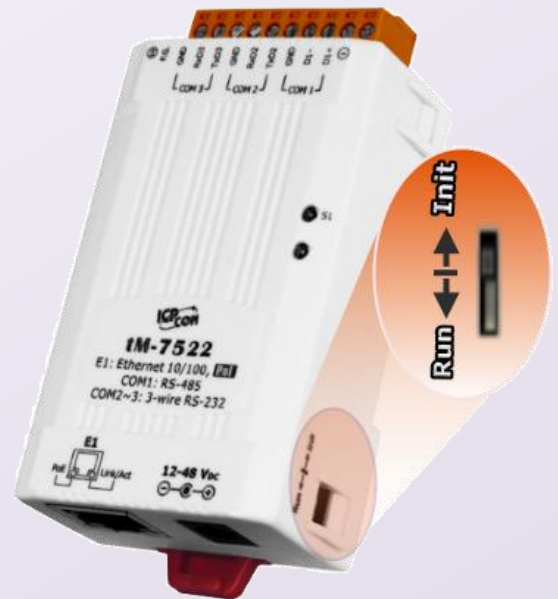

5. Serial COM Ports:

The numbers of serial COM Ports depend on the types of tM-752N modules. For more detailed information regarding the pin assignments of the Serial COM ports, please refer to [Section 2.6 “Pin Assignments”](#).

2.5 Dimensions

tM-7521/tM-7522 Dimensions:

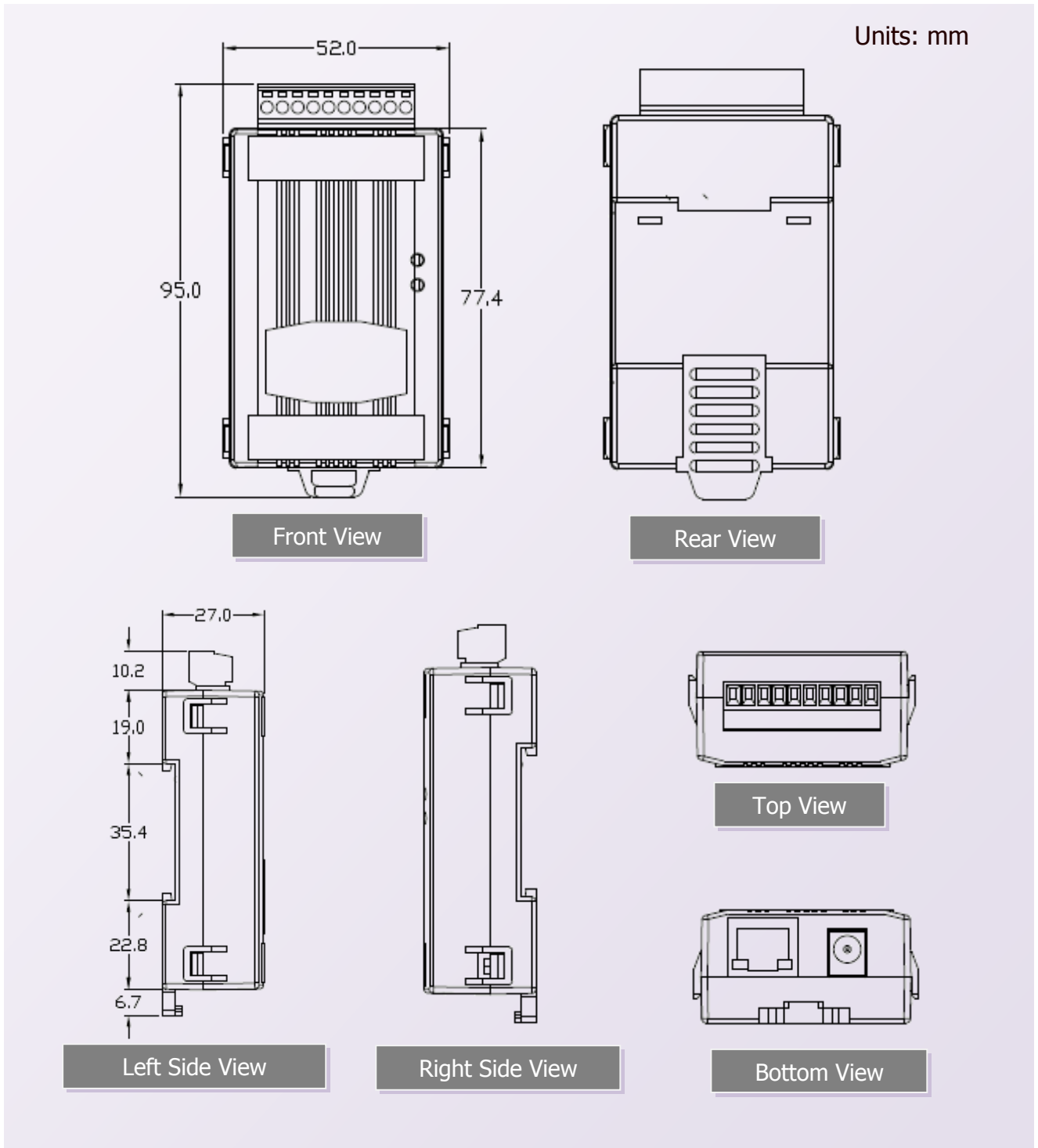

2.6 Pin Assignments

tM-7521 Pin Assignments

1-Port 2-Wire RS-485 and 1-Port
5-Wire RS-232 Module

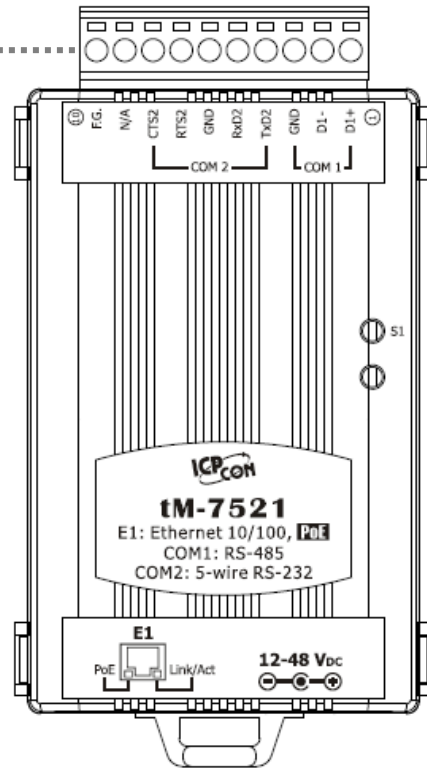
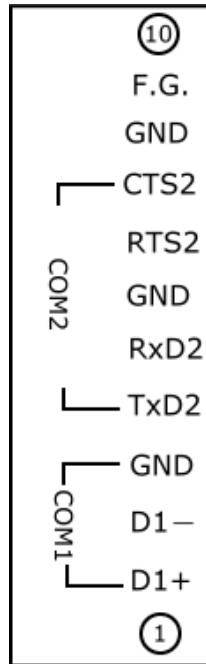

tM-7522 Pin Assignments

1-Port 2-Wire RS-485 and 2-Port
3-Wire RS-232 Module

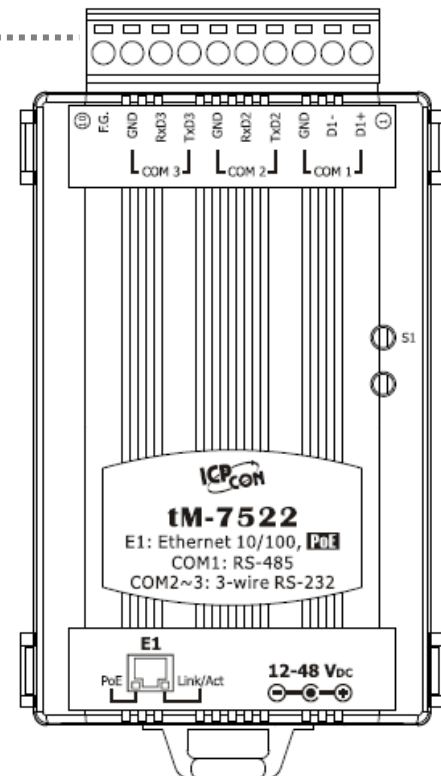
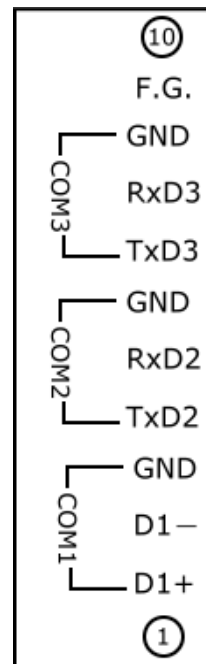

2.7 Wiring Notes

RS-232 Wiring Connection

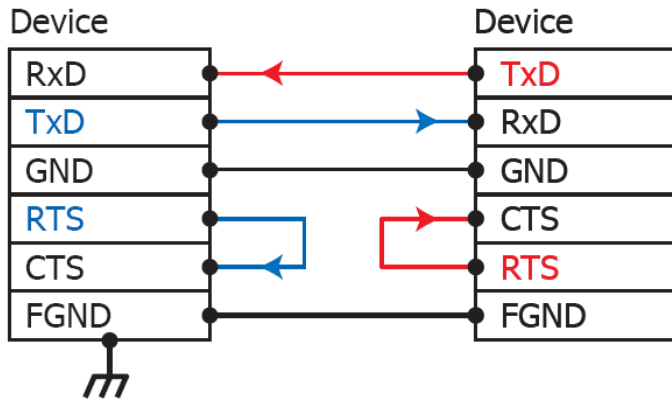

Note:

1. For 3-Wire RS-232 connections, it is recommended that unused signals such as RTS/CTS and DTR/DSR are shorted, since some systems may still check the status of CTS and DSR.
2. FGND is the frame ground that provides a path to earth ground for ESD protection.

RS-485 Wiring Connection

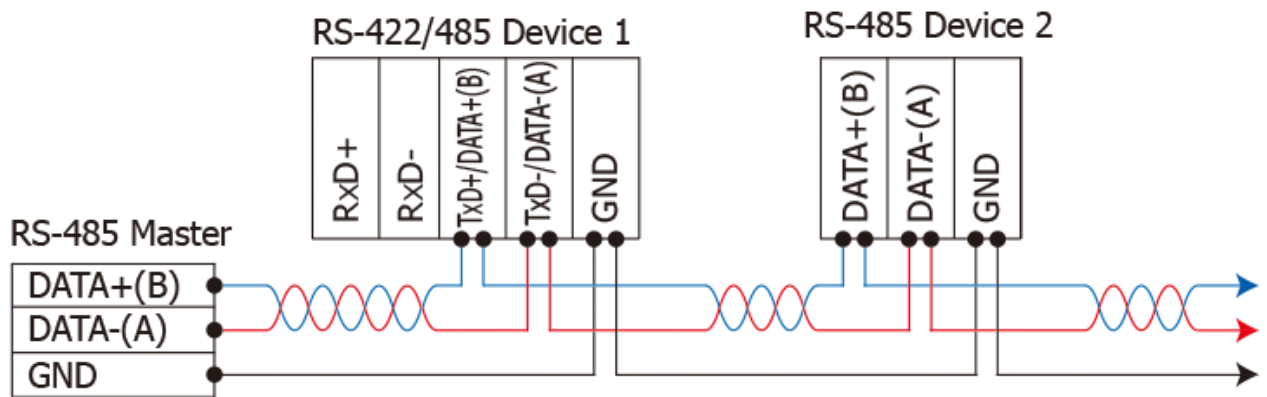

2-wire Only Device

- Note:** 1. Usually, you have to connect all signal grounds of RS-485 devices together to reduce common-mode voltage between devices.
2. Twisted-pair cable must be used for the DATA+/- wires.
 3. Both two ends of the cable may require a termination resistor connected across the two wires (DATA+ and DATA-). Typically 120 Ω resistors are used.
 4. The Data+ and B pins are positive-voltage pins, and Data- and A pins are negative-voltage pins in the above figure. The B/A pins may be defined in another way depending on devices, please check it first.

3. Setting up the tM-752N

Prepare for device:

- Hub/Switch: NS-205PSE or NS-205 (optional)
- Isolated RS-232 to RS-422/485 converter module: I-7520 module (optional)

Step 1: Connecting the power and Host PC

1. Check Init/Run switch is on “Run” position.



2. Connect both the tM-752N and your computer to the same sub network or the same Ethernet Switch, and power the tM-752N on. Make sure the System LED indicator is flashing.

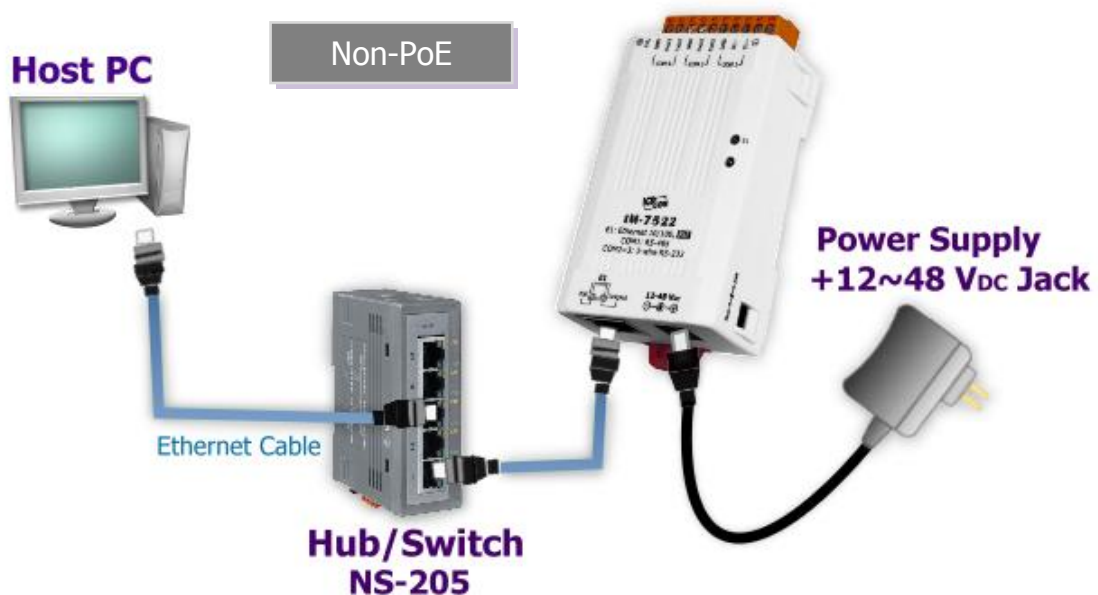

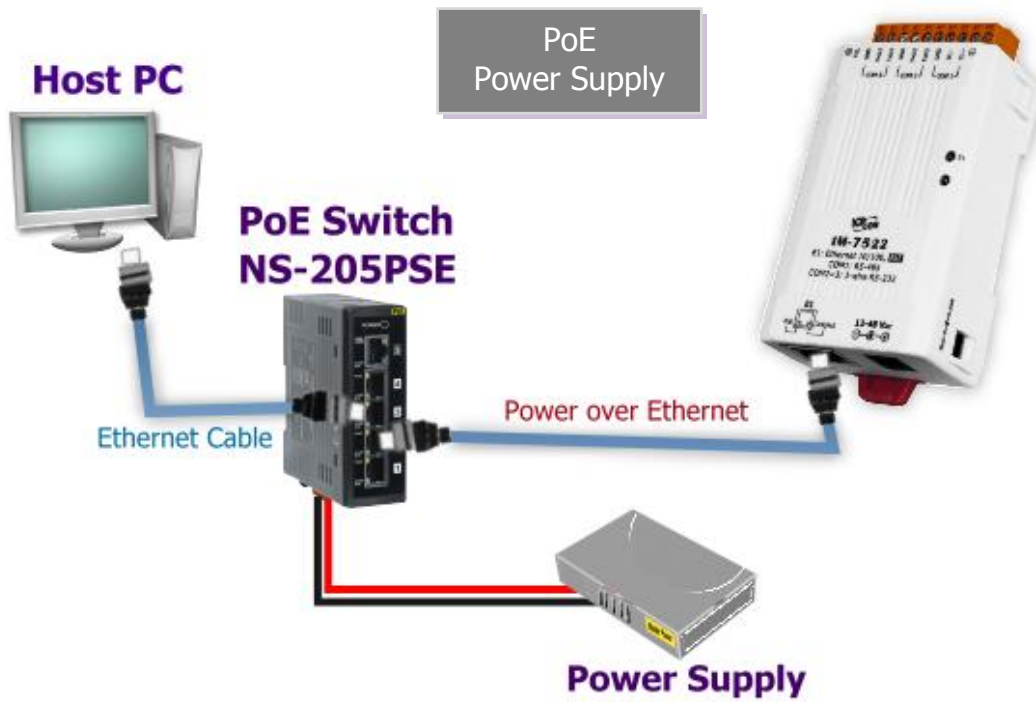

3. Perform a test wiring check as follows:

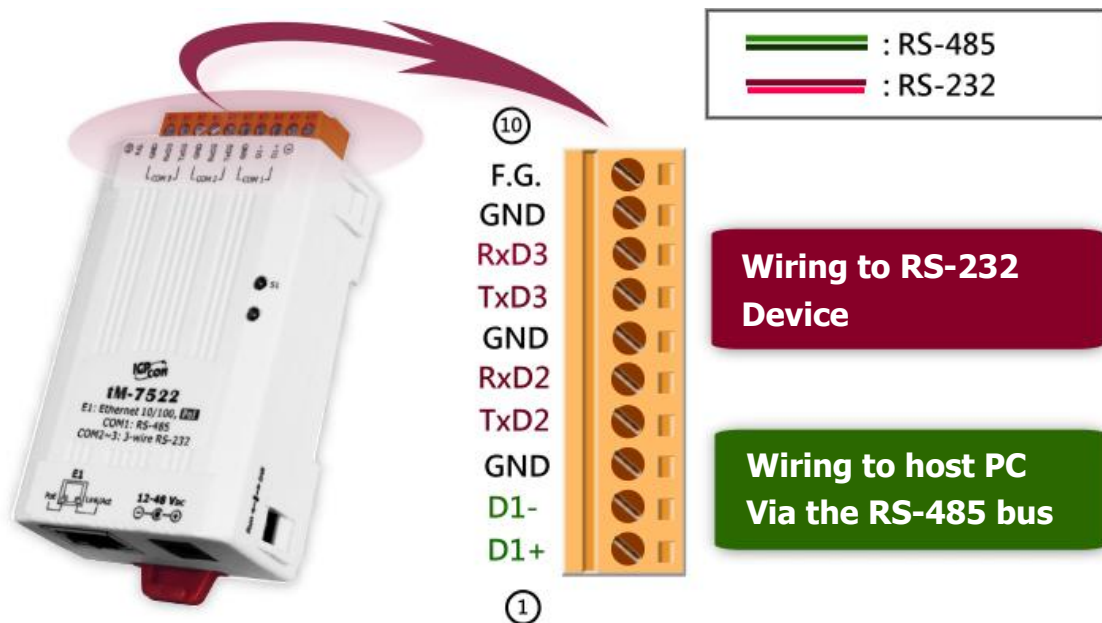

4. Connecting to **Multiple Remote RS-232 Devices** as follows:

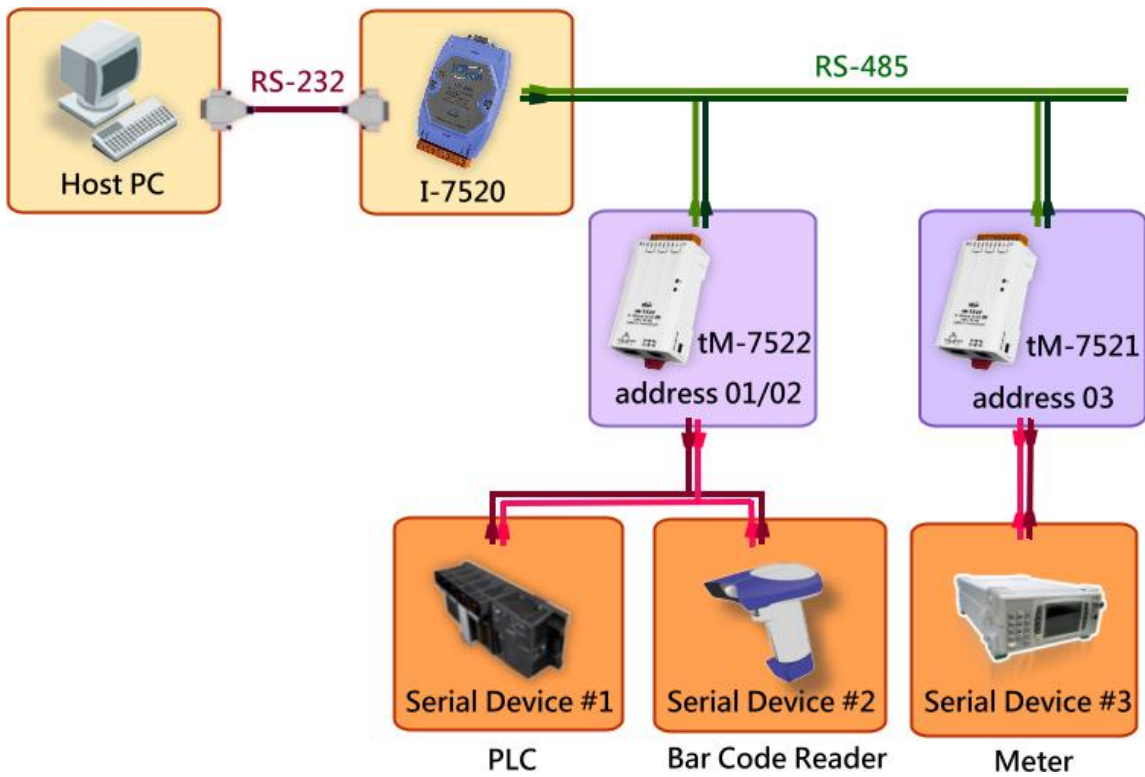

Step 2: Run the eSearch Utility

The eSearch Utility can be obtained from our FTP site:

<http://ftp.icpdas.com/pub/cd/tinymodules/napdos/software/esearch/>



Step 3: Search for the tM-752N module

Click the “Search Servers” button to search for your tM-752N module.

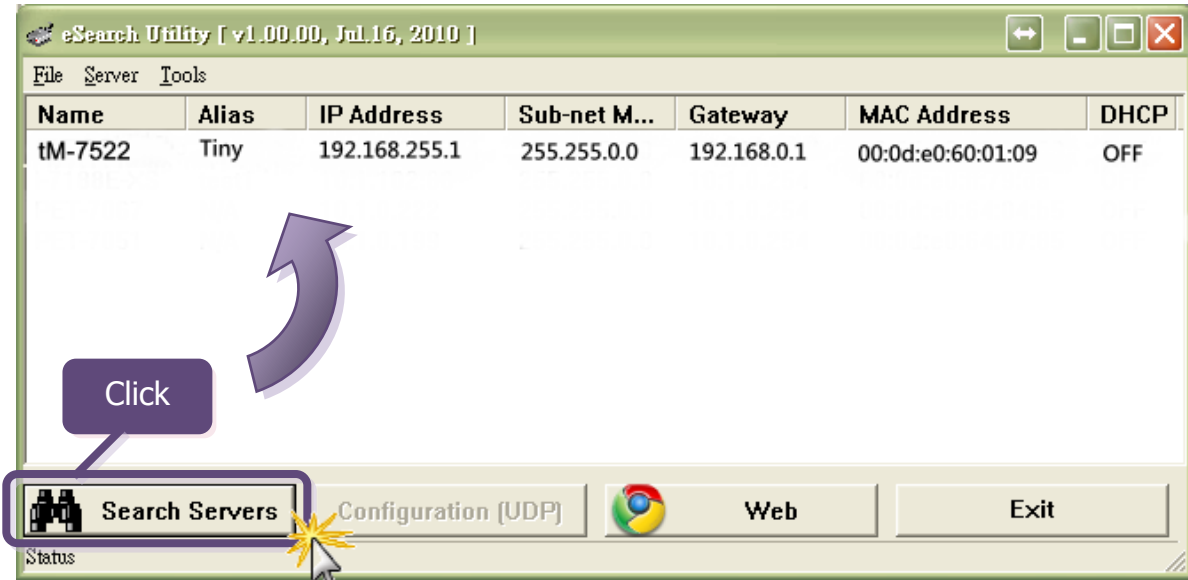

Step 4: Configure the network settings

1. tM-752N series module are IP-based devices that may not be suitable for your network using a default IP address. Therefore, you must first assign a new IP address to the tM-752N module depending on your network settings.

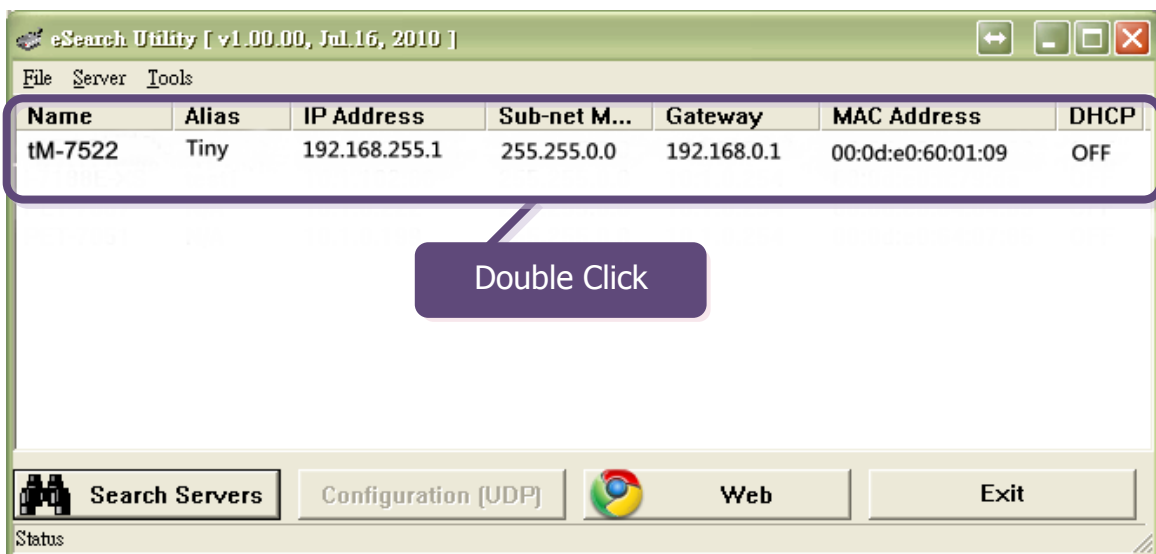

2. Contact your Network Administrator to obtain the correct network configuration information such as **IP/Mask/Gateway**. Enter the network settings and then click **“OK”**. The tM-752N will use the new settings within 2 seconds.

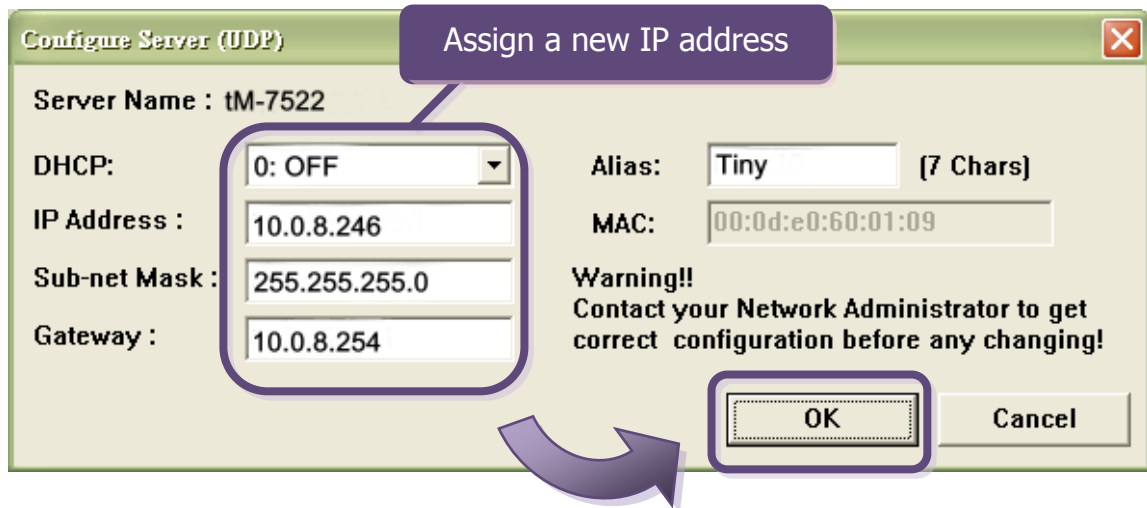

Step 5: Testing your tM-752N module

1. Execute your hyper terminal program or our **“Terminal.exe”**.

The Terminal.exe can be obtained from our FTP site:

<http://ftp.icpdas.com/pub/cd/tinymodules/napdos/software/>

2. Check that the configuration of the COM Port is correct and then click the **“Open COM”** button.

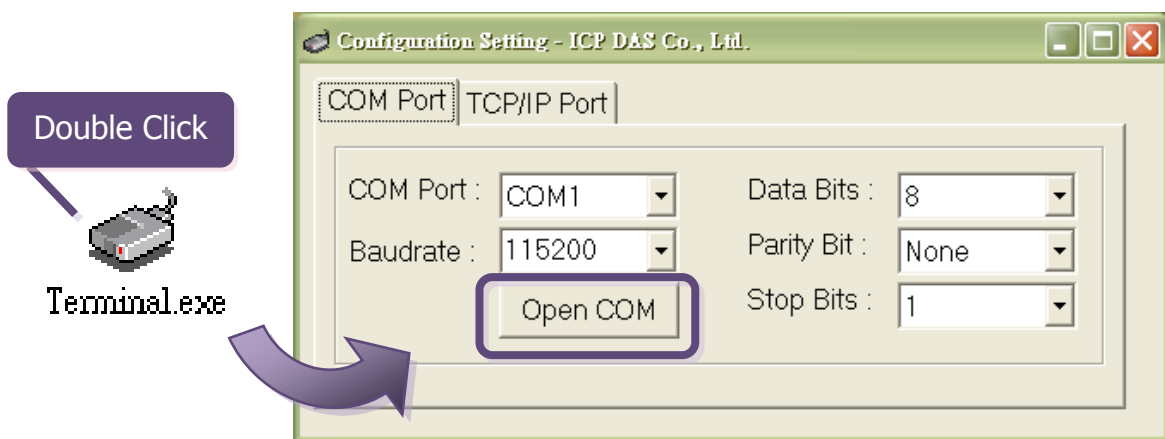

3. Type a string in the send field then click the **“Send”** button. If a response is received, it will be displayed in the received field.

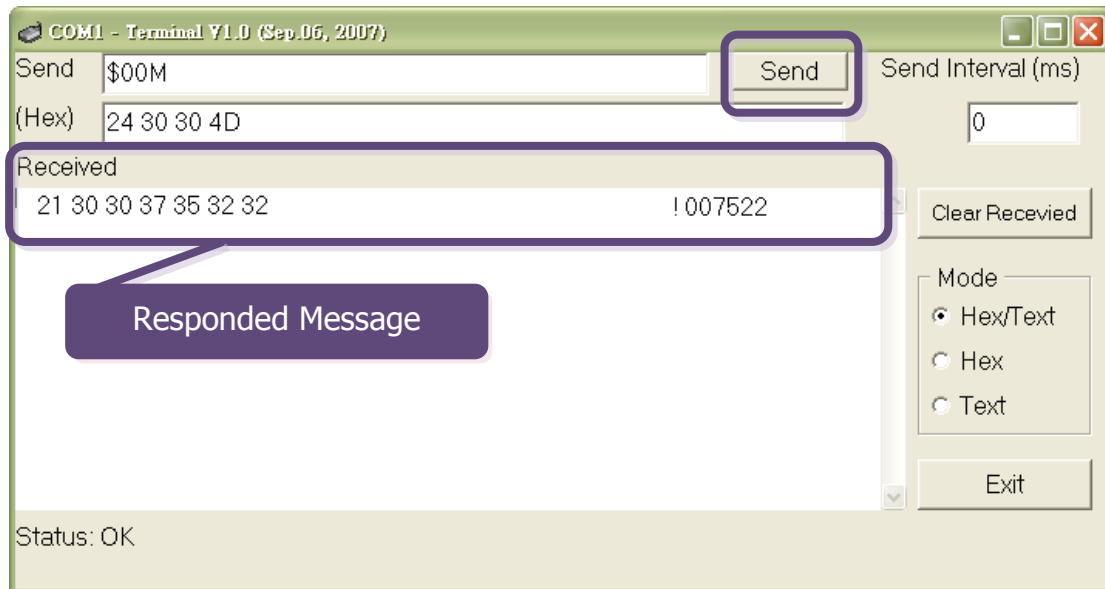

Note: For more detailed information regarding the command sets, please refer to [Section 5 “Command Sets”](#).

4. Web Configuration

The tM-752N module can be configured via serial port (refer to [chapter 5](#)) and also can be configured via web browser after its network is setting and functioning correctly.

4.1 Logging on to the tM-752N Web Server

You can log onto the tM-752N web server from any computer that has Internet access.

Step 1: Open a browser

Mozilla Firefox, Google Chrome and Internet Explorer, for example are reliable and popular internet browsers that can be used to configure tM-752N modules.



Step 2: Type the URL address of the tM-752N

Make sure you have correctly configured the network settings for the tM-752N, or refer to [Section 3 “Setting up the tM-752N”](#).



Step 3: Enter the password

After entering the IP address, the login dialog page will be displayed. Enter the password, and then click the “**Submit**” button to enter the configuration web page.

The factory default password is:

Item	Default
Login password	admin

tM-752N Series

[Home](#) | [Port1](#) | [Network Setting](#) | [Filter](#) | [Change Password](#) | [Logout](#)

The system is logged out.
To enter the web configuration, please type password in the following field.

Login password:

Step 4: Welcome to tM-752N Web Server

After logging onto the tM-752N web server, the main page will appear.

tM-752N Series

[Home](#) | [Port1](#) | [Network Setting](#) | [Filter](#) | [Change Password](#) | [Logout](#)

Status & Configuration

Model Name:	tM-752N	Alias Name:	0457
Firmware Version:	v1.0.4 [Jul.13, 2012]	MAC Address:	00-0D-E0-80-00-36
IP Address:	10.0.8.100	System Address:	0x00 (0)
Initial Switch:	OFF	System Timeout (Serial Watchdog, Seconds):	300

Current port settings:

Port Settings	Port 1
Baud Rate (bps):	115200
Data Size (bits):	8
Parity:	None
Stop Bits (bits):	1
Flow Control:	None
Serial Ending Chars:	-
Port ID:	0x00 (0)
Delimiter:	:
Response Timeout (ms):	1000

Copyright © 2009 ICP DAS Co., Ltd. All rights reserved

4.2 Home Page

The Home link connects to the main page, which contains two parts.

tM-752N Series

Home
[Port1](#) | [Port2](#) | [Network Setting](#) | [Filter](#) | [Change Password](#) | [Logout](#)

The first part of this page provides basic information about the tM-752N hardware and software.

Status & Configuration

Model Name: tM-7521	Alias Name: Tiny
Firmware Version: v1.0.0 [Sep.02, 2011]	MAC Address: 00-0D-E0-80-12-22
IP Address: 10.1.0.47	System Address: 0x00 (0)
Initial Switch: OFF	System Timeout (Serial Watchdog, Seconds): 300

The second part of this page provides the status of the port settings.

Current port settings:

Port Settings	Port 1	Port 2
Baud Rate (bps):	115200	115200
Data Size (bits):	8	8
Parity:	None	None
Stop Bits (bits):	1	1
Flow Control:	None	None
Serial Ending Chars:	-	-
Port ID:	0x00 (0)	0x00 (0)
Delimiter:	:	:
Response Timeout (ms):	1000	1000
Continue Response Timeout (ms):	-	0

4.3 Network Setting

tM-752N Series

[Home](#) | [Port1](#) | [Port2](#) | Network Setting | [Filter](#) | [Change Password](#) | [Logout](#)

4.3.1 Network and Miscellaneous Settings

- Check the model name and the software information.
- The software information includes the following items:
Firmware Version, Model Name, IP Address, Initial Switch, MAC Address, and System Timeout.

Network and Miscellaneous Settings	
Model Name: tM-7521	Alias Name: Tiny
Firmware Version: v1.0.0 [Sep.02, 2011]	MAC Address: 00-0D-E0-80-12-22
IP Address: 10.1.0.47	System Address: 0x00 (0)
Initial Switch: OFF	System Timeout (Serial Watchdog, Seconds) 300



After updating the tM-752N firmware, you can check the version information on this page.

4.3.2 IP Address Selection

The **Address Type**, **Static IP Address**, **Subnet Mask** and **Default Gateway** items are the most important network settings and should always correspond to the LAN definition. If they do not match, the tM-752N module will not operate correctly. If the settings are changed while the module is operating, any links to Virtual COM Port based applications currently in use will be lost and an error will occur.

IP Address Selection

Address Type:	DHCP/AutoIP <input type="button" value="v"/>			
Static IP Address:	<input type="text" value="0"/>	<input type="text" value="0"/>	<input type="text" value="0"/>	<input type="text" value="0"/>
Subnet Mask:	<input type="text" value="0"/>	<input type="text" value="0"/>	<input type="text" value="0"/>	<input type="text" value="0"/>
Default Gateway:	<input type="text" value="0"/>	<input type="text" value="0"/>	<input type="text" value="0"/>	<input type="text" value="0"/>
MAC Address:	<input type="text" value="00-0D-E0-80-12-22"/> (Format: FF-FF-FF-FF-FF-FF)			
<input type="button" value="Update Settings"/>				

Item Descriptions:

Item	Description
Address Type	Static IP: If you don't have a DHCP server in your network, you can configure the network settings manually. Please refer to the Section "4.3.2.1 Manually Configuration"
	DHCP/AutoIP: Dynamic Host Configuration Protocol (DHCP) is a network application protocol that automatically assigns an IP address to each device. Please refer to Section 4.3.2.2 "Dynamic Configuration"
Static IP Address	Each tM-752N on the network must have a unique IP address. This item used to assign specific IP address.
Subnet Mask	The Subnet Mask indicates which portion of the IP address is used to identify the local network or subnet.
Default Gateway	A gateway (or router) is a system that is used to connect an individual network with one or more additional networks.
MAC Address	The User-defined MAC address.
Update Settings	Click this button to save the new settings to the tM-752N.

Network settings can be configured using either dynamic configuration or manual configuration, as per the following instructions:

4.3.2.1 Manual Configuration

When using manual configuration, you have to assign all the network settings in the following manner:

- Step 1: Select “**Static IP**” as the address type
- Step 2: Enter the appropriate **network settings**
- Step 3: Click the “**Update Settings**” button to finish the configuration

Address Type:	Static IP	Step1
Static IP Address:	10 . 0 . 8 . 246	Step2
Subnet Mask:	255 . 255 . 255 . 0	
Default Gateway:	10 . 0 . 8 . 254	
MAC Address:	00-0D-B0-80-00-04	(Format: FF-FF-FF-FF-FF-FF)
		Update Settings Step3

4.3.2.2 Dynamic Configuration

Dynamic configuration is very easy to perform. If you have a DHCP server, the network address can be dynamically configured in the following manner:

- Step 1: Select “**DHCP/AutoIP**” as the address type
- Step 2: Click the “**Update Settings**” button to finish the configuration

Address Type:	DHCP/AutoIP	Step1
Static IP Address:	10 . 0 . 8 . 246	
Subnet Mask:	255 . 255 . 255 . 0	
Default Gateway:	10 . 0 . 8 . 254	
MAC Address:	00-0D-B0-80-00-04	(Format: FF-FF-FF-FF-FF-FF)
		Update Settings Step2

4.3.3 General Configuration Settings

The General Configuration Settings provides functions allowing items such as the Alias Name, System Timeout value, and Auto-logout value to be configured.

General Configuration Settings

System Address (ID)	<input type="text" value="0x00"/>
Enable Checksum	<input type="text" value="0"/> (0: Disable, 1: Enable)
Enable Response Prefix	<input type="text" value="0"/> (0: Disable, 1: Enable)
Alias Name:	<input type="text" value="Tiny"/> (Max. 18 chars)
System Timeout: (Network Watchdog)	<input type="text" value="300"/> (30 ~ 65535 seconds, Default= 300, Disable= 0)
Web Auto-logout	<input type="text" value="10"/> (1 ~ 65535 minutes, Default= 10, Disable= 0)
<input type="button" value="Update Settings"/>	

Item Descriptions:

Item	Description	Default
System Address	A module address (Net ID) for tM-752N module	0
Enable Checksum	Add a checksum in the last field of message 0 = Disable (default); 1 = Enable;	0
Enable Response Prefix	Add the prefix code in front of response message	0
Alias Name	Each tM-752N can be allocated a unique Alias name so that it can be identified the network.	Tiny
System Timeout (Network Watchdog)	If no communication occurs for a certain period in serial port, the system will be rebooted based on the configured system timeout value. Settings range: 30 ~ 65535 (seconds); Disabled = 0;	300
Web Auto-logout	If there is no action for a certain period in the web server, user account will be logout. Settings range: 1 ~ 65535 (minutes); Disable = 0;	10
Update Settings	Click this button to save the new settings to the tM-752N.	

4.3.4 Restore Factory Defaults

To reset the settings to their factory defaults, follow these steps:

- Step 1: Click the “**Restore Defaults**” button to reset the configuration.
- Step 2: Click the “**OK**” button in the message dialog box.
- Step 3: Check whether the tM-752N is reset to factory default settings for use with the eSearch.exe. Refer to [Section 3 “Setting up the tM-752N”](#).

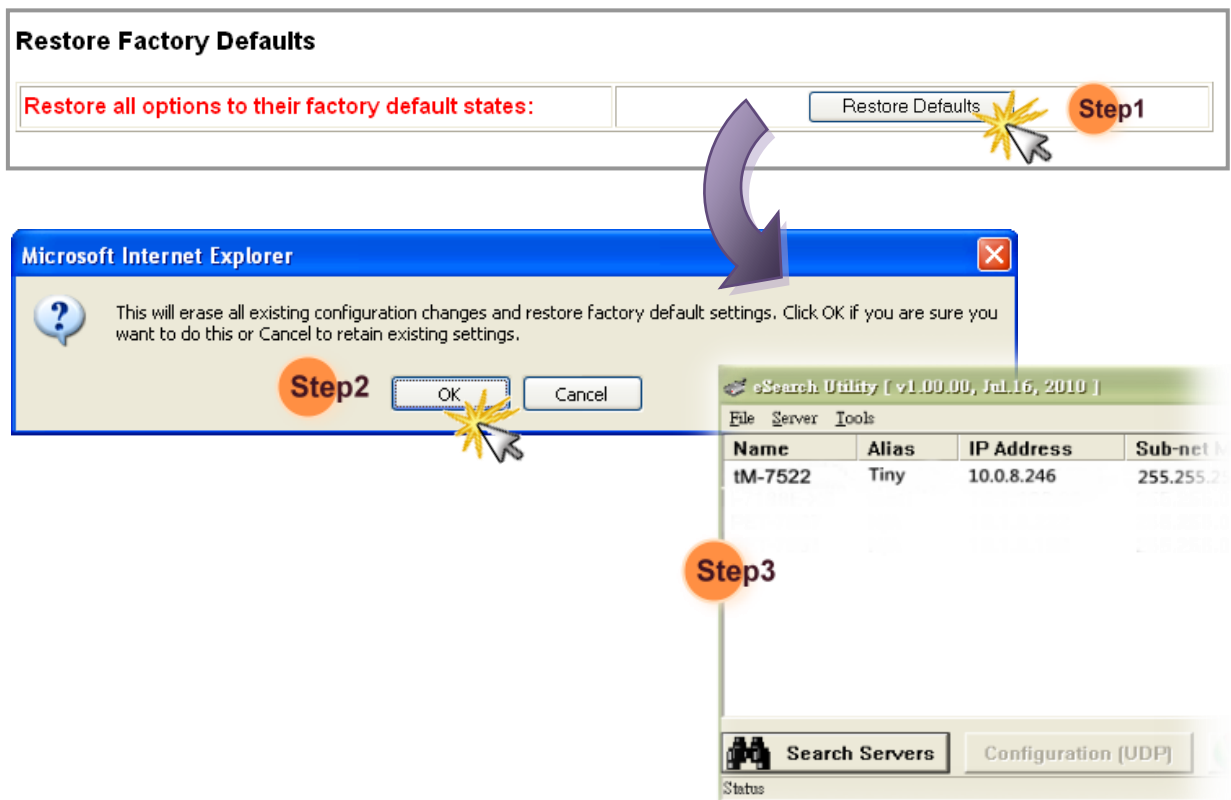

Default Settings:

Item	Factory Default Settings
IP	192.168.255.1
Gateway	192.168.0.1
Mask	255.255.0.0

4.4 Serial Port Settings

tM-752N Series

[Home](#)
Port1
Port2
[Network Setting](#) | [Filter](#) | [Change Password](#) | [Logout](#)

4.4.1 Port1 Settings

Check the tM-752N hardware and software information.

Model Name: tM-7521	Alias Name: Tiny
Firmware Version: v1.0.0 [Sep.02, 2011]	MAC Address: 00-0D-E0-80-12-22
IP Address: 10.1.0.47	System Address: 0x00 (0)
Initial Switch: OFF	System Timeout (Serial Watchdog, Seconds): 300

The port settings provide the following functions:

These are 5 modes in ending-chars pattern.

Mode 0: 0x0D ; Mode 1: 0x0D,0x0A ; Mode 2: 0x0A,0x0D ; Mode 3: 0x0A ;

Mode 4: No Ending-Chars; Mode 5: User-defined (Byte count, Chars)

Port Settings	Current	Updated
Baud Rate (bps):	115200	<input type="text" value="115200"/> <input type="button" value="v"/> bits/S
Data Size (bits):	8	<input type="text" value="8"/> <input type="button" value="v"/> bits/character
Parity:	None	<input type="text" value="None"/> <input type="button" value="v"/>
Stop Bits(bits):	1	<input type="text" value="1"/> <input type="button" value="v"/>
Flow Control:	None	<input type="text" value="None"/> <input type="button" value="v"/>
Serial Ending Chars:	4	<input type="text" value="None"/> <input type="button" value="v"/> <input type="text" value="0"/> (e.g.:
Delimiter:	:	<input type="text" value=":"/> (Can't use "\$%#@ ~?>")
Port ID:	0x00	(=System ID)
Response Timeout(ms):	1000	<input type="text" value="1000"/> ms (Default= 300 ms, Disable=
Continue Response Timeout(ms):	0	<input type="text" value="0"/> ms (Default= 100 ms, Disable=
<input type="button" value="Submit"/>		

Item Descriptions:

Item	Description	Default
Baud Rate (bps)	Sets the Baud Rate for the COM ports.	115200
Data Size (bits)	Sets the Data Size for the COM ports.	8
Parity	Sets the Parity for the COM ports.	None
Stop Bits (bits)	Sets the Stop Bits for the COM ports.	1
Flow Control	Sets the Flow Control for the COM ports.	None
Serial Ending Chars	<p>The tM-752N can determine the end of the data immediately after the ending-chars pattern is identified from the incoming serial data.</p> <p>There are some different modes can be used: Mode 0 → 0x0D (CR) Mode 1 → 0x0D+0x0A (CR+LF) Mode 2 → 0x0A+0x0D (LF+CR) Mode 3 → 0x0A (LF) Mode 4 → None (Disabled) Mode 5 → User-Defined (Note: Mode 5 can only set in web configuration)</p> <p>The number of User-defined ending-char can be 1~2 chars. For example: 1 char: 1,0x0D; 2 chars: 2,0x0D,0x0A</p>	4
Delimiter	This is a special symbol, placed in the front of command/response message, can be used to identify the legality of message.	:
Port ID	The Port ID (port address) can be used to identify each RS-232 port; the value is the increasing value of System address.	0
Response Timeout	<p>For Port 1 (RS-485) in end character mode is "4" (it means that No end character), wait for this timeout to elapse without receiving any further data in order to determine the end of the command.</p> <p>For Port 2 and 3 (RS-232), wait for this timeout to elapse without receiving any data.</p>	1000
Continue Response Timeout	<p>Timeout value between chars of response data.</p> <p>Only used for Port 2 and 3 (RS-232) in end character mode is "4" (it means that No end character),</p> <p>If the time between receiving a new character and last one is smaller this timeout, this character can be seem as part of a response.</p>	0

4.5 Filter

tM-752N Series

[Home](#) | [Port1](#) | [Port2](#) | [Network Setting](#) | **Filter** | [Change Password](#) | [Logout](#)

For detailed network and miscellaneous settings description, refer to [section 4.3.1 “Network and Miscellaneous Settings”](#).

4.5.1 Filter Settings

This filter settings page is used to query or edit IP filter list. The IP filter list restricts the access of packets based on the IP header. If one or more IP address are saved into the IP filter table, only clients whose IP is specified in the IP filter list can access the tM-752N.

Filter Settings:

IP Filter List	IP Address
IP1:	0.0.0.0
IP2:	0.0.0.0
IP3:	0.0.0.0
IP4:	0.0.0.0
IP5:	0.0.0.0

Add . . . To The List
 Delete IP#
 Delete ALL
 Save to Flash

Item Descriptions:

Item	Description
Add “IP” to the list	Adds an IP address to the IP filter list
Delete IP# “number”	Deletes IP# from the IP filter list
Delete All	Deletes all items from the IP filter list
Save to Flash	Save a new IP filter list to the Flash
Submit	Click this button to save the new settings to the tM-752N

4.6 Change Password

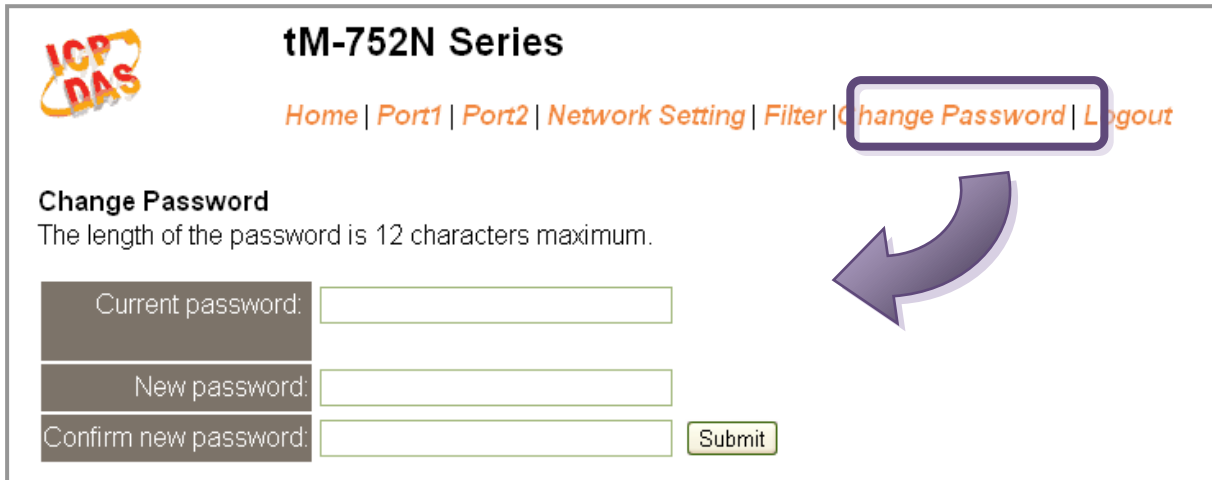

ICP DAS **tM-752N Series**

[Home](#) | [Port1](#) | [Port2](#) | [Network Setting](#) | [Filter](#) | **Change Password** | [Logout](#)

Change Password
The length of the password is 12 characters maximum.

Current password:

New password:

Confirm new password:

Item Descriptions:

Item	Description
Current password	Enter the old password (default is admin)
New password	Enter the new password
Confirm new password	Enter the new password again
Submit	Click this button to save the new settings to the tM-752N.

4.7 Logout

Click the “**Logout**” tag to log out from the system and return to the login page.

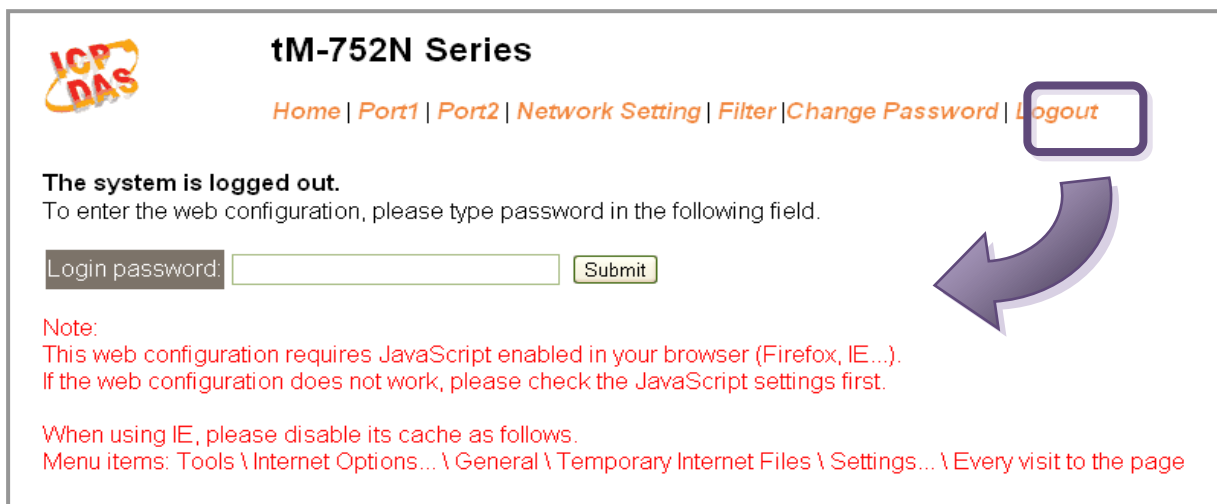

ICP DAS **tM-752N Series**

[Home](#) | [Port1](#) | [Port2](#) | [Network Setting](#) | [Filter](#) | [Change Password](#) | **Logout**

The system is logged out.
To enter the web configuration, please type password in the following field.

Login password:

Note:
This web configuration requires JavaScript enabled in your browser (Firefox, IE...).
If the web configuration does not work, please check the JavaScript settings first.

When using IE, please disable its cache as follows.
Menu items: Tools \ Internet Options... \ General \ Temporary Internet Files \ Settings... \ Every visit to the page

5. Command Sets

5.1 Command Sets Table

- Address Table (“AA” means the modules address)

Model	Module Address	COM1 Address	COM2 Address	COM3 Address
tM-7521	AA	AA	AA	-
tM-7522	AA	AA	AA	AA+1

- Command Sets Table:

Section	Command	Response	Description
5.1.1	\$AAA[addr]	!AA	Read/Set the module Address
5.1.2	\$AABN[baud rate]	!AA[baud rate]	Read/Set the Baud Rate for COM-1/2/3
5.1.3	\$AADN[data-bit]	!AA[data-bit]	Read/Set the Data Bit for COM-1/2/3
5.1.4	\$AAPN[parity-bit]	!AA[parity-bit]	Read/Set the Parity Bit for COM-1/2/3
5.1.5	\$AAON[stop-bit]	!AA[stop-bit]	Read/Set the Stop Bit for COM-1/2/3
5.1.6	\$AA6[ID]	!AA	Set the alias name string for COM-2/3
5.1.7	\$AA7	!AA[ID]	Read the alias name string for COM-2/3
5.1.8	\$AAC[delimiter]	!AA[delimiter]	Read/Set the delimiter for COM-2/3
5.1.9	(delimiter)AA(bypass)	Depend on device	Bypass the data string to COM-2/3
5.1.10	\$AAKV	!AA[checksum]	Read/Set the checksum status of COM1 (RS485)
5.1.11	\$AATN[CrLfmode]	!AA[CrLfmode]	Read/Set the end char which is used to judge the end of command/response for COM1/2/3
5.1.12	\$AAM	!AA[name]	Read the module name
5.1.13	\$AAU	[data]	Read data from the RS-232 COM port buffer.
5.1.14	\$AAJN	!AA[timeout]	Reads/Sets the delay time before determining whether the end of a Command/response has been sent/received
5.1.15	\$AAEV	!AA(status)	Read/Set prefixed address status on the response

5.1.1 \$AAA[addr]

■ **Description:** This function reads/sets the module address.

■ **Syntax:**

\$AAA[chk](CrLf)	Reads the module address stored in the Flash
\$AAA[addr][chk](CrLf)	Sets the module address

[Request]

Byte 1	Byte 2-3	Byte 4	Byte 5-6	Byte 7-8	Byte 9-10	Note
\$	AA	A	[chk]	(CrLf)	-	Read
			[addr]	[chk]	(CrLf)	Write
<p>\$ Delimiter character</p> <p>AA 2-character module address in Hex format. The valid range is from 00~FF</p> <p>[chk] 2-character checksum. If the checksum is disabled → no [chk]</p> <p>(CrLf) End Character</p>						

[Response]

Byte 1	Byte 2-3	Byte 4-5	Byte 6-7	Note
!	AA	[chk]	(CrLf)	Valid
?				Invalid
<p>! Delimiter character indicating a valid command</p> <p>? Delimiter character indicating an invalid command</p> <p>AA 2-character module address in Hex format</p> <p>[chk] 2-character checksum. If the checksum is disabled → no [chk]</p> <p>(CrLf) End Character</p> <p>If No response → syntax error, communication error, or address error</p>				

■ **Example:**

e.g.	Command	Response
1	\$01A02(CrLf)	!01(CrLf)
	The module address 01 is changed to 02.	
2	\$02AA0(CrLf)	!02(CrLf)
	The module address 02 is changed to A0.	
3	\$A0A(CrLf)	!A0(CrLf)
	The module address is A0.	

5.1.2 \$AABN[baud rate]

■ **Description:** This function reads/sets the Baud Rate for COM 1/2/3.

■ **Syntax:**

\$AABN [chk](CrLf)	Reads the Baud Rate for COM 1/2/3 stored in the Flash
\$AABN [baud rate][chk](CrLf)	Sets the Baud rate for COM 1/2/3

[Request]

Byte 1	Byte 2-3	Byte 4	Byte 5	Byte 6-7	Byte 8-9	Byte 10-11	Note
\$	AA	B	N	[chk]	(CrLf)	-	Read
				[baud rate]	[chk]	(CrLf)	Write
<p>\$ Delimiter character</p> <p>AA 2-character port address in Hex format. The valid range is from 00~FF</p> <p>N 0 = Read/Set the Baud Rate for the COM 1 1 = Read/Set the Baud Rate for the COM 2/3</p> <p>[baud rate] Valid values are 1200/2400/4800/9600/19200/38400/57600/115200</p> <p>[chk] 2-character checksum. If the checksum is disabled → no [chk]</p> <p>(CrLf) End Character</p>							

[Response]

Byte 1	Byte 2-3	Byte 4-6	Byte 7-8	Byte 9-10	Note
!	AA	[baud rate]	[chk]	(CrLf)	Read

Byte 1	Byte 2-3	Byte 4-5	Byte 6-7	Note
!	AA	[chk]	(CrLf)	Valid
?				Invalid

!	Delimiter character indicating a valid command
?	Delimiter character indicating an invalid command
AA	2-character port address in Hex format
[baud rate]	Valid values are 1200/2400/4800/9600/19200/38400/57600/115200
[chk]	2-character checksum. If the checksum is disabled → no [chk]
(CrLf)	End Character
If No response → syntax error, communication error, or address error	

- **Example:**
 (Assume the module address of tM-752N is 01)

e.g.	Command	Response
1	\$01B0(CrLf)	!0157600(CrLf)
	Read the COM1 (RS-485) Baud Rate.	
2	\$01B19600(CrLf)	!01(CrLf)
	Changes the COM2 (RS-232) Baud Rate to 9600 bps.	
3	\$02B138400(CrLf)	!02(CrLf)
	Changes the COM3 (RS-232) Baud Rate to 38400 bps.	

5.1.3 \$AADN[data-bit]

■ **Description:** This function reads/sets the data bit for COM 1/2/3.

■ **Syntax:**

\$AADN [chk](CrLf)	Reads the data bit for COM 1/2/3 stored in the Flash
\$AADN [data-bit][chk](CrLf)	Sets the data bit for COM 1/2/3

[Request]

Byte 1	Byte 2-3	Byte 4	Byte 5	Byte 6-7	Byte 8-9	Byte 10-11	Note
\$	AA	D	N	[chk]	(CrLf)	-	Read
				[data-bit]	[chk]	(CrLf)	Write
<p>\$ Delimiter character</p> <p>AA 2-character port address in Hex format. The valid range is from 00~FF</p> <p>N 0 = Reads/Sets the data bit for the COM 1 1 = Reads/Sets the data bit for the COM 2/3</p> <p>[data-bit] Valid values are 5/6/7/8</p> <p>[chk]: 2-character checksum. If the checksum is disabled → no [chk]</p> <p>(CrLf): End Character</p>							

[Response]

Byte 1	Byte 2-3	Byte 4	Byte 5-6	Byte 7-8	Note
!	AA	[data-bit]	[chk]	(CrLf)	Read

Byte 1	Byte 2-3	Byte 4-5	Byte 6-7	Note
!	AA	[chk]	(CrLf)	Valid
?				Invalid
<p>! Delimiter character indicating a valid command</p> <p>? Delimiter character indicating an invalid command</p> <p>AA 2-character port address in Hex format</p> <p>[chk] 2-character checksum. If the checksum is disabled → no [chk]</p> <p>(CrLf) End Character</p> <p>If no response → syntax error, communication error, or address error</p>				

- **Example:**
 (Assume the module address of tM-752N is 01)

e.g.	Command	Response
1	\$01D08(CrLf)	!01(CrLf)
	Changes the data bit to 8 for the COM1 (RS-485)	
2	\$01D17(CrLf)	!01(CrLf)
	Changes the data bit to 7 for the COM2 (RS-232)	
3	\$02D17(CrLf)	!02(CrLf)
	Changes the data bit to 7 for the COM3 (RS-232)	

5.1.4 \$AAPN[parity-bit]

- **Description:** This function reads/sets the parity bit for COM 1/2/3.

- **Syntax:**

\$AAPN[chk](CrLf)	Reads the parity bit for COM 1/2/3 stored in the Flash
\$AAPN[parity-bit][chk](CrLf)	Sets the parity bit for COM 1/2/3

[Request]

Byte 1	Byte 2-3	Byte 4	Byte 5	Byte 6-7	Byte 8-9	Note
\$	AA	P	N	[chk]	(CrLf)	Read

Byte 1	Byte 2-3	Byte 4	Byte 5	Byte 6	Byte 7-8	Byte 9-10	Note
\$	AA	P	N	[parity-bit]	[chk]	(CrLf)	Write

\$	Delimiter character						
AA	2-character port address in Hex format. The valid range is from 00~FF 0 = Reads/Sets						
N	the parity bit for the COM 1						
	1 = Reads/Sets the parity bit for the COM 2/3						
[parity-bit]	0=NONE, 1=EVEN, 2=ODD, 3=MARK, 4=SPACE						
[chk]	2-character checksum. If the checksum is disabled → no [chk]						
(CrLf)	End Character						

[Response]

Byte 1	Byte 2-3	Byte 4	Byte 5-6	Byte 7-8	Note
!	AA	[parity-bit]	[chk]	(CrLf)	Read

Byte 1	Byte 2-3	Byte 4-5	Byte 6-7	Byte 8-9	Note
!	AA	[chk]	(CrLf)	-	Valid
?					Invalid

!	Delimiter character indicating a valid command				
?	Delimiter character indicating an invalid command				
AA	2-character port address in Hex format				
[chk]	2-character checksum. If the checksum is disabled → no [chk]				
(CrLf)	End Character				
If No response → syntax error, communication error, or address error					

■ **Example:**

(Assume the module address of tM-752N is 01)

e.g.	Command	Response
1	\$01P00(CrLf)	!01(CrLf)
	Changes parity-bit to NONE for COM1 (RS-485)	
2	\$01P10(CrLf)	!01(CrLf)
	Changes parity-bit to NONE for COM2 (RS-232)	
3	\$02P11(CrLf)	!02(CrLf)
	Changes parity-bit to EVEN for COM3 (RS-232)	

5.1.5 \$AAON[stop-bit]

■ **Description:** This function reads/sets the stop bit for COM 1/2/3.

■ **Syntax:**

\$AAON[chk](CrLf)	Reads the stop bit of COM 3 stored in the Flash
\$AAON[stop-bit][chk](CrLf)	Sets the stop bit for COM 3

[Request]

Byte 1	Byte 2-3	Byte 4	Byte 5	Byte 6-7	Byte 8-9	Note
\$	AA	O	N	[chk]	(CrLf)	Read

Byte 1	Byte 2-3	Byte 4	Byte 5	Byte 6	Byte 7-8	Byte 9-10	Note
\$	AA	O	N	[stop-bit]	[chk]	(CrLf)	Write

\$ Delimiter character
 AA 2-character port address in Hex format. The valid range is from 00~FF
 N 0 = Reads/Sets the stop bit for the COM 1
 1 = Reads/Sets the stop bit for the COM 2/3
 [stop-bit] Valid values are 1/2
 [chk] 2-character checksum. If the checksum is disabled → no [chk]
 (CrLf) End Character

[Response]

Byte 1	Byte 2-3	Byte 4	Byte 5-6	Byte 7-8	Note
!	AA	[stop-bit]	[chk]	(CrLf)	Read

Byte 1	Byte 2-3	Byte 4-5	Byte 6-7	Byte 8-9	Note
!	AA	[chk]	(CrLf)	-	Valid
?					Invalid

! Delimiter character indicating a valid command
 ? Delimiter character indicating an invalid command
 AA 2-character port address in Hex format
 [chk] 2-character checksum. If the checksum is disabled → no [chk]
 (CrLf) End Character

If no response → syntax error, communication error, or address error

- **Example:**
 (Assume the module address of tM-752N is 01)

e.g.	Command	Response
1	\$01O12(CrLf)	!02(CrLf)
	Changes the stop bit to 2 for the COM2 (RS-232)	
2	\$02O12(CrLf)	!03(CrLf)
	Changes the stop bit to 2 of the COM3 (RS-232)	

5.1.6 \$AA6[name]

- **Description:** This function sets the alias-name string for COM 2/3. Max-number of characters = 15.

- **Syntax:**

\$AA6[ID][chk](CrLf)	Sets the alias-name string for COM 2/3
----------------------	--

[Request]

Byte 1	Byte 2-3	Byte 4	Byte 5-12	Byte 13-14	Byte 15-16
\$	AA	6	[name]	[chk]	(CrLf)
\$	Delimiter character				
AA	2-character port address in the Hex format. The valid range is from 00~FF				
[name]	Alias-name string, (Max-number of character is 15)				
[chk]	2-character checksum. If the checksum is disabled → no [chk]				
(CrLf)	End Character				

[Response]

Byte 1	Byte 2-3	Byte 4-5	Byte 6-7	Note
!	AA	[chk]	(CrLf)	Valid
?				Invalid
!	Delimiter character indicating a valid command			
?	Delimiter character indicating an invalid command			
AA	2-character port address in Hex format			
[chk]	2-character checksum. If the checksum is disabled → no [chk]			
(CrLf)	End Character			
If no response → syntax error, communication error, or address error				

- **Example:**

(Assume the module address of tM-752N is 01)

e.g.	Command	Response
1	\$016Temperature1(CrLf)	!01(CrLf)
	Set alias-name of COM2 (RS-232) as "Temperature 1".	
2	\$026HP34401A-1(CrLf)	!02(CrLf)
	Set alias-name of COM3 (RS-232) as "HP34401A-1".	

5.1.7 \$AA7

- **Description:** This function reads the alias-name string for COM 2/3.

- **Syntax:**

\$AA7[chk](CrLf)

Reads the alias-name string for COM 2/3

[Request]

Byte 1	Byte 2-3	Byte 4	Byte 5-6	Byte 7-8
\$	AA	7	[chk]	(CrLf)
\$	Delimiter character			
AA	2-character port address in Hex format. The valid range is from 00~FF			
[chk]	2-character checksum. If the checksum is disabled → no [chk]			
(CrLf)	End Character			

[Response]

Byte 1	Byte 2-3	Byte 4-10	Byte 11-12	Byte 13-14	Note
!	AA	[name]	[chk]	(CrLf)	Read

Byte 1	Byte 2-3	Byte 4-5	Byte 6-7	Note
?	AA	[chk]	(CrLf)	Invalid

! Delimiter character indicating a valid command
 ? Delimiter character indicating an invalid command
 AA 2-character port address in Hex format
 (name) Alias-name string. Maximum number of characters=15
 [chk] 2-character checksum. If the checksum is disabled → no [chk]
 (CrLf) End Character

If no response → syntax error, communication error, or address error

- **Example:**

(Assume the module address of tM-752N is 01)

e.g.	Command	Response
1	\$017(CrLf)	!01Temperature1(CrLf)
	The alias name for the RS-232 (COM2) is Temperature1	
2	\$027(CrLf)	!02HP34401A-1(CrLf)
	The alias name for the RS-232 (COM3) is HP34401A-1	

5.1.8 \$AAC[delimiter]

- **Description:** This reads/sets the delimiter for COM 2/3.

- **Syntax:**

\$AAC[chk](CrLf)	Reads the delimiter for COM 2/3 stored in the Flash
\$AAC[delimiter][chk](CrLf)	Sets the delimiter for COM 2/3

[Request]

Byte 1	Byte 2-3	Byte 4	Byte 5-6	Byte 7-8	Note	
\$	AA	C	[chk]	(CrLf)	Read	
Byte 1	Byte 2-3	Byte 4	Byte 5	Byte 6-7	Byte 8-9	Note
\$	AA	C	[delimiter]	[chk]	(CrLf)	Write
\$	Delimiter character					
AA	2-character port address in Hex format. The valid range is from 00~FF					
[delimiter]	Default delimiter is :					
[chk]	2-character checksum. If the checksum is disabled → no [chk]					
(CrLf)	End Character					

[Response]

Byte 1	Byte 2-3	Byte 4	Byte 5-6	Byte 7-8	Note
!	AA	[delimiter]	[chk]	(CrLf)	Read
Byte 1	Byte 2-3	Byte 4-5	Byte 6-7	Note	
!	AA	[chk]	(CrLf)	Valid	
?				Invalid	
!	Delimiter character indicating a valid command				
?	Delimiter character indicating an invalid command				
AA	2-character port address in Hex format				
[chk]	2-character checksum. If the checksum is disabled → no [chk]				
(CrLf)	End Character				
If no response → syntax error, communication error ,or address error					

- **Example:**
 (Assume the module address of tM-752N is 01)

e.g.	Command	Response
1	\$01C(CrLf)	!01:(CrLf)
	Reads the delimiter for the COM2 (RS-232)	
2	\$02C*(CrLf)	!02:(CrLf)
	Changes the delimiter for the COM3 (RS-232)	
Notes: (1) The delimiter of COM 2/3 can be different. (2) The default delimiter is “ : ” (3) The delimiter cannot be “ \$ ”, “ ~ ”, “ # ”, “ @ ”, “ % ”, “ CR & LF ”		

5.1.9 [delimiter]AA[bypass]

- **Description:** This function bypasses the data string to COM 2/3.

- **Syntax:**

(delimiter)**AA**(pass)[chk](CrLf) Bypasses the data string to COM 2/3

[Request]

Byte 1	Byte 2-3	Byte 4 - n	Byte (n+1) - (n+2)	Byte (n+3) - (n+4)
(delimiter)	AA	(bypass)	[chk]	(CrLf)
AA	2-character port address in Hex format. The valid range is from 00~FF			
(bypass)	The data string sent to COM 2/3			
[chk]	2-character checksum. If the checksum is disabled → no [chk]			
(CrLf)	End Character			

[Response]

The response received will depend on the device used.

- **Example:**

(Assume the module address of tM-752N is 01.

The delimiters for COM2/3 are “:” and “*”, respectively)

e.g.	Command	Response
1	:01abcde(CrLf)	Depends on the device
	Send abcde to COM2	
2	*02test(CrLf)	Depends on the device
	Send test to COM3	

5.1.10 \$AAKV

■ **Description:** This function reads/sets the checksum status.

■ **Syntax:**

\$AAK[chk](CrLf)	Reads the checksum status stored in the Flash
\$AAKV[chk](CrLf)	Sets the checksum status

[Request]

Byte 1	Byte 2-3	Byte 4	Byte 5-6	Byte 7-8	Note	
\$	AA	K	[chk]	(CrLf)	Read	
Byte 1	Byte 2-3	Byte 4	Byte 5	Byte 6-7	Byte 8-9	Note
\$	AA	K	[V]	[chk]	(CrLf)	Write
\$	Delimiter character					
AA	2-character module address in Hex format. The valid range is from 00~FF					
V	0 = checksum disabled 1 = checksum enabled					
[chk]	2-character checksum. If the checksum is disabled → no [chk]					
(CrLf)	End Character					

[Response]

Byte 1	Byte 2-3	Byte 4	Byte 5-6	Byte 7-8	Note
!	AA	[V]	[chk]	(CrLf)	Read
Byte 1	Byte 2-3	Byte 4-5	Byte 6-7	Note	
!	AA	[chk]	(CrLf)	Valid	
?				Invalid	
!	Delimiter character indicating a valid command				
?	Delimiter character indicating an invalid command				
AA	2-character module address in Hex format				
V	0 = checksum disabled 1 = checksum enabled				
[chk]	2-character checksum. If the checksum is disabled → no [chk]				
(CrLf)	End Character				
If no response: → syntax error, communication error, or address error					

■ **Example:**

(Assume the module address of tM-752N is 01.)

e.g.	Command	Response
1	\$01K000(CrLf)	!0182(CrLf)
	Disables the checksum chk: 00,82	
2	\$01K1(CrLf)	!01(CrLf)
	The checksum is enabled	
<p>Notes: The checksum enable/disable function is valid for COM1, since the checksum is used in communication between tm-752N and host PC. Not for serial devices!</p>		

5.1.11 \$AATN[CrLfmode]

- **Description:** This function reads/sets what the characters are as judging the end of command or response string.

- **Syntax:**

\$AATN[chk](CrLf)	Reads the setting value of CrLfmode stored in the Flash
\$AATN(CrLfmode)[chk](CrLf)	Sets the setting value of CrLfmode for the command/response string

[Request]

Byte 1	Byte 2-3	Byte 4	Byte 5	Byte 6-7	Byte 8-9	Note
\$	AA	T	N	[chk]	(CrLf)	Read

Byte 1	Byte 2-3	Byte 4	Byte 5	Byte 6	Byte 7-8	Byte 9-10	Note
\$	AA	T	N	[CrLfmode]	[chk]	(CrLf)	Write

\$	Delimiter character						
AA	2-character port address in Hex format. The valid range is from 00~FF						
N	0 = Reads/Sets the CrLfmode value of the COM 1 1 = Reads/Sets the CrLfmode value of the COM 2/3						
(CrLfmode)	0 = (CrLf)=0x0D (CR) 1 = (CrLf)=0x0D+0x0A (CR+LF) 2 = (CrLf)=0x0A+0x0D (LF+CR) 3 = (CrLf)=0x0A (LF) 4 = No end character						
[chk]	2-character checksum. If the checksum is disabled →no [chk]						
(CrLf)	End Character						

[Response]

Byte 1	Byte 2-3	Byte 4	Byte 5-6	Byte 7-8	Note
!	AA	[CrLfmode]	[chk]	(CrLf)	Read

Byte 1	Byte 2-3	Byte 4-5	Byte 6-7	Note
!	AA	[chk]	(CrLf)	Valid
?				Invalid

!	Delimiter character indicating a valid command
?	Delimiter character indicating an invalid command
AA	2-character port address in Hex format
[chk]	2-character checksum. If the checksum is disabled →no [chk]
(CrLf)	End Character
If No response → syntax error, communication error, or address error	

■ **Example:**

(Assume the module address of tM-752N is 01.)

e.g.	Command	Response
1	\$01T0(CrLf)	!014(CrLf)
	The end char for COM1 is no end character	
2	\$01T1(CrLf)	!011(CrLf)
	The end char for COM2 is 0x0D+0x0A	
3	\$02T1(CrLf)	!022(CrLf)
	The end char for COM3 is 0x0A	

Notes:
The default CrLfmode = 4 → ie.the default (CrLf)=NONE for all port.

5.1.12 \$AAM

- **Description:** This function reads the module name.

- **Syntax:**

\$AAM[chk](CrLf)	Reads the module name
------------------	-----------------------

[Request]

Byte 1	Byte 2-3	Byte 4	Byte 5-6	Byte 7-8	Note
\$	AA	M	[chk]	(CrLf)	Read
\$	Delimiter character				
AA	2-character Hex module address, The valid range is from 00~FF				
[chk]	2-character checksum. If the checksum is disabled → no [chk]				
(CrLf)	End Character				

[Response]

Byte 1	Byte 2-3	Byte 4-6	Byte 7-8	Byte 9-10	Note
!	AA	(name)	[chk]	(CrLf)	Read

Byte 1	Byte 2-3	Byte 4-5	Byte 6-7	Note
?	AA	[chk]	(CrLf)	Invalid

!	Delimiter character indicating a valid command				
?	Delimiter character indicating an invalid command				
AA	2-character Hex module address				
(name)	4 or 5-character value/string denoting the module name				
[chk]	2-character checksum. If the checksum is disabled → no [chk]				
(CrLf)	End Character				

If no response → syntax error, communication error, or address error

- **Example:**

e.g.	Command	Response
1	\$01M(CrLf)	!017521(CrLf)
	The name of module 01 is 7521	
2	\$02M(CrLf)	!027522(CrLf)
	The name of module 02 is 7522	

5.1.13 \$AAU

■ **Description:**

Most RS-232 devices are passive and obey the rules of the request-reply protocol. If they do not receive any commands, they will not send any messages out. However, more and more active devices are developed to send out message automatically. So, ICPDAS tM-752N controllers are designed with a 1-KB queue buffer on each RS-232 port to store these active messages until the Host PC has time to read it. The feature allows the Host PC linking with hundreds of RS-232 devices without any loss of data in short period.

Buffer operation rules:

Rule 1: The buffer is enabled after being powered-on.

Rule 2: The (delimiter) AA command disables the buffer operation for that port.

Rule 3: After disabling the buffer, the controller will wait for X seconds (=Response timeout,) for a response from the RS-232 device. The response will then be transferred to COM1. If no message is received, the buffer will be re-enabled.

■ **Syntax:**

\$AAU[chk](CrLf)

Reads data from the RS-232 COM port buffer

[Request]

Byte 1	Byte 2-3	Byte 4	Byte 5-6	Byte 7-8	Note
\$	AA	U	[chk]	(CrLf)	Read
\$	Delimiter character				
AA	2-character port address in Hex format. The valid range is from 00~FF				
[chk]	2-character checksum. If the checksum is disabled → no [chk]				
(CrLf)	End Character				

[Response]

Byte 1 – n	Byte (n+1) – (n+2)	Byte (n+3) – (n+4)	Note
!	AA	(name)	Read

Byte 1	Byte 2-3	Byte 4-5	Byte 6-7	Note
?	AA	[chk]	(CrLf)	Invalid

!	Delimiter character indicating a valid command			
?	Delimiter character indicating an invalid command			
AA	2-character port address in Hex format			
[chk]	2-character checksum. If the checksum is disabled → no [chk]			
(CrLf)	End Character			
If no response → The buffer is empty, syntax error or communication error, or address error				

■ **Example:**

e.g.	Command	Response
1	\$01U(CrLf)	data1(CrLf)
	Retrieves “data1” from the buffer of the port that is addressed 01	
2	\$01U(CrLf)	data2
	Retrieves another data: “data2” from the buffer of the port that is addressed 01	
3	\$02U(CrLf)	
	No data in the buffer of the port that is addressed 02	

5.1.14 \$AAJN[timeout]

■ **Description:**

The function reads/sets the delay time before determining whether the end of a Command/response has been sent and received.

If the timeout value for the RS-232 COM Port is too small, the response part will be received by the 1K byte Queue buffer for RS-232 Ports. The \$AAU command can be used to read the buffer. Refer to section 5.1.13 for more information.

■ **Syntax:**

\$AAJN [chk] (CrLf)	Reads the timeout value
\$AAJN[timeout] [chk] (CrLf)	Sets the timeout value

[Request]

Byte 1	Byte 2-3	Byte 4	Byte 5	Byte 6-7	Byte 8-9	Note
\$	AA	J	N	[chk]	(CrLf)	Read

Byte 1	Byte 2-3	Byte 4	Byte 5	Byte 6 - n	Byte (n+1) - (n+2)	Byte (n+3) - (n+4)	Note
\$	AA	J	N	[timeout]	[chk]	(CrLf)	Write

\$	Delimiter character						
AA	2-character port address in Hex format. The valid range is from 00~FF						
N	0 = COM 1 timeout 1 = COM 2/3 Response timeout (Timeout value after sending request/command string.) 2= COM 2/3 Continuous response timeout (Timeout value between chars of the response data.)						
[timeout]	Delay time value (ms). Valid range is 0 to 4294967259.						
[chk]	2-character checksum. If the checksum is disabled → no [chk]						
(CrLf)	End Character						

[Response]

Byte 1	Byte 2-3	Byte 4	Byte 5-6	Byte 7-8	Note
!	AA	[timeout]	[chk]	(CrLf)	Read

Byte 1	Byte 2-3	Byte 4-5	Byte 6-7	Note
!	AA	[chk]	(CrLf)	Valid
?				Invalid

!	Delimiter character indicating a valid command
?	Delimiter character indicating an invalid command
AA	2-character port address in Hex format
[chk]	2-character checksum. If the checksum is disabled → no [chk]
(CrLf)	End Character
If no response → buffer is empty, syntax error, communication error, address error	

- **Example:**
(Assume the module address of tM-752N is 01.)

e.g.	Command	Response
1	\$01J01000(CrLf)	!01(CrLf)
	Sets the timeout value for the COM1 (RS-485) to 1000ms	
2	\$01J11500(CrLf)	!01(CrLf)
	Sets the timeout value of the COM2 (RS-232) to 1500ms	
3	\$01J1(CrLf)	!011500(CrLf)
	Reads the Response timeout value of COM2 The Response timeout value of COM2 is 1500ms.	

Notes: The default Response timeout value for all RS-232 COM ports is 1000 ms.
--

5.1.15 \$AAEV

■ **Description:**

This function reads/sets the status of the prefixed address byte (port address) on the response. This lets host know the response is coming from which RS-232 device.

■ **Syntax:**

\$AAEV [chk] (CrLf)	Reads the status of the prefixed address byte on the response
---------------------	---

[Request]

Byte 1	Byte 2-3	Byte 4	Byte 5	Byte 6-7	Byte 8-9	Note
\$	AA	E	V	[chk]	(CrLf)	Read
\$	Delimiter character					
AA	2-character port address in Hex format. The valid range is from 00~FF					
V	0 = Prefixed address byte disabled 1 = Prefixed address byte enabled					
[chk]	2-character checksum. If the checksum is disabled → no [chk]					
(CrLf)	End Character					

[Response]

Byte 1	Byte 2-3	Byte 4	Byte 5-6	Byte 7-8	Note
!	AA	[V]	[chk]	(CrLf)	Read
Byte 1	Byte 2-3	Byte 4-5	Byte 6-7	Note	
!	AA	[chk]	(CrLf)	Valid	
?				Invalid	
!	Delimiter character indicating a valid command				
?	Delimiter character indicating an invalid command				
AA	2-character port address in Hex format				
V	0 = Prefixed address byte disabled 1 = Prefixed address byte enabled				
[chk]	2-character checksum. If the checksum is disabled → no [chk]				
(CrLf)	End Character				
If no response → syntax error, communication error, or address error					

- **Example:**
(Assume the module address of tM-752N is 01.)

e.g.	Command	Response
1	\$01E(CrLf)	!010(CrLf)
	Reads the status of the prefixed address byte for COM1. The prefixed address byte is disabled.	
2	\$01E1(CrLf)	!01(CrLf)
	Sets the status of the prefixed address byte to enable.	

Notes:

If the prefixed address byte is enabled, the response for [delimiter]AA[bypass data] and \$AAU will be prefixed with !AA.

Example 1: [delimiter]AA[bypass data]

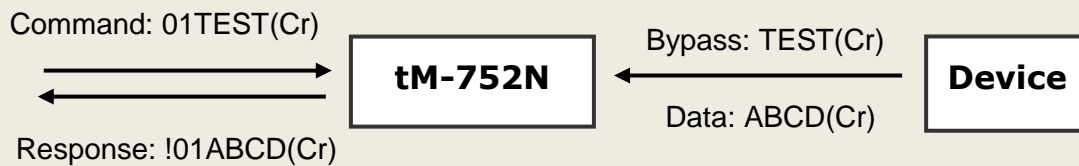

Example 2: \$AAU



6. Typical Applications

6.1 Application 1

Addressable RS-232 Controller (Command Type)

- Each tM-752N module has a unique address.
- The Host PC first sends a command to all tM-752N series modules.
- The destination tM-752N module will pass the command to its local RS-232 device.
- The destination tM-7522 module will then send the response from the RS-232 device back to the Host PC.

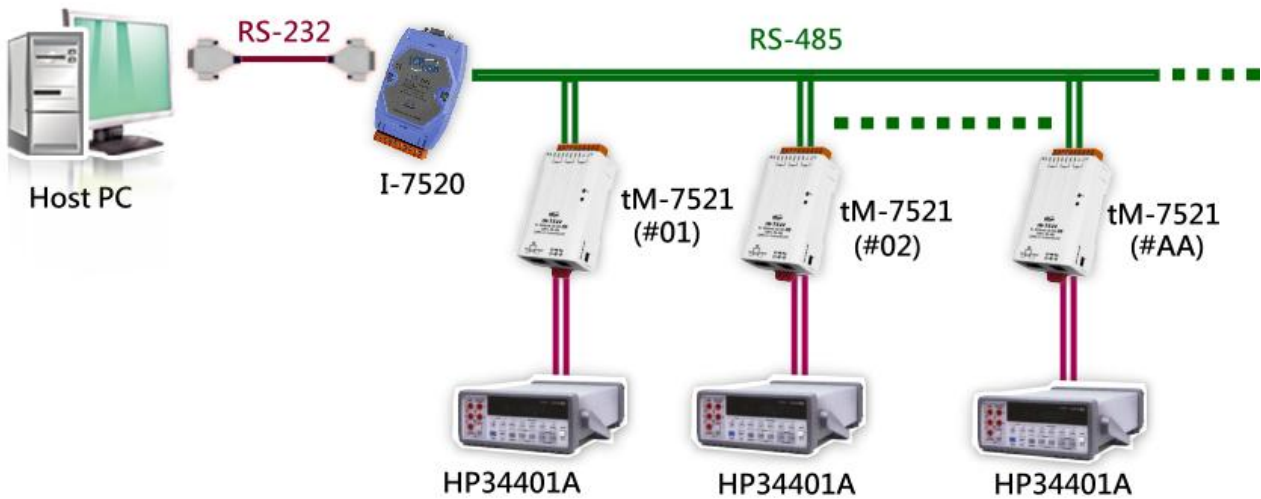

6.2 Application 2

Addressable RS-232 Controller (Receive Data only Type)-Barcode Reader

- The barcode-reader can scan a barcode at anytime, and the tM-752N module will store these barcodes in an internal buffer (1 K bytes).
- The Host PC first sends \$AAU command to each tM-752N modules one-by-one. The destination tM-752N module will check its internal buffer. If there are any barcode data in the buffer, the tM-752N module will then send all barcode data back to the Host PC.

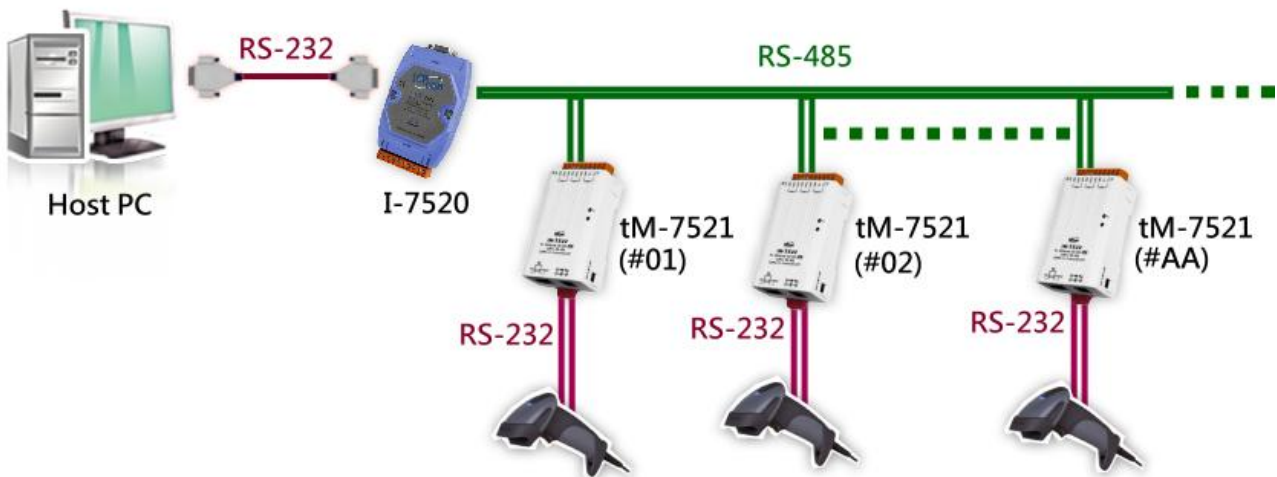

6.3 Application 3

Addressable RS-232 Controller (Dual-channel)

- Each tM-7522 module has a unique address
- Each tM-7522 module can support two RS-232 devices, AA and AA+1.
- The Host PC first sends a command to each tM-7522 modules one-by-one.
- The destination tM-752N module will pass the command to its local RS-232 device 1 or RS-232 device 2.
- The tM-752N module then sends the response from the RS-232 device back to the Host PC.
- The RS-232 device can be used for command (Application 1) or null command (Application 2) type controller applications.

