

VP-23W1/VP-25W1 User Manual

Version 1.0.7, March 2012

Service and usage information for



VP-23W1



VP-25W1

Written by Mac Cho

Edited by Anna Huang

Warranty

All products manufactured by ICP DAS are under warranty regarding defective materials for a period of one year, beginning from the date of delivery to the original purchaser.

Warning

ICP DAS assumes no liability for any damage resulting from the use of this product. ICP DAS reserves the right to change this manual at any time without notice. The information furnished by ICP DAS is believed to be accurate and reliable. However, no responsibility is assumed by ICP DAS for its use, not for any infringements of patents or other rights of third parties resulting from its use.

Copyright

Copyright © 2012 by ICP DAS Co., Ltd. All rights are reserved.

Trademark

The names used for identification only may be registered trademarks of their respective companies.

Contact US

If you have any problem, please feel free to contact us.
You can count on us for quick response.

Email: service@icpdas.com

Table of Contents

Table of Contents	3
1. Introduction	7
1.1. Features	8
1.2. Specifications.....	10
1.3. Overview.....	12
1.4. Dimensions	17
1.5. Companion CD	19
2. Getting Started	20
2.1. Mounting the Hardware	21
2.1.1. Removing the Slot Cover.....	21
2.1.2. Installing Expansion I/O Sockets	22
2.1.3. Installing the I/O Modules	23
2.1.4. Mounting the Waterproof	25
2.1.5. Mounting the ViewPAC	27
2.1.6. Deploying a Basic ViewPAC Application.....	29
2.2. Configuring the Boot Mode	30
2.3. Testing the ViewPAC.....	34
2.4. Using ViewPAC Utility to manage the ViewPAC	36
2.5. Using DCON Utility to Configure the I/O Modules.....	37
2.6. Using Backup Utility to back up the settings and files.....	39
2.7. A caution about using System_Disk.....	41
3. Tools and Tasks.....	42

3.1. DCON Utility	45
3.2. NAPOPC_CE5.....	46
3.3. SendToCOM	47
3.4. VCEP.....	48
3.5. ViewPAC Utility	49
3.5.1. Menu Bar	50
3.5.2. Property Tabs	55

4. Your First ViewPAC Program67

4.1. Preparing the Development Tools.....	68
4.2. Installing ViewPAC SDKs.....	69
4.3. Understanding the ViewPAC APIs	70
4.3.1. ViewPAC SDK Overview	71
4.3.2. ViewPAC SDK Reference.....	74
4.4. Your First Program in C#	76
4.4.1. Create a new project	77
4.4.2. Add project reference for an application	79
4.4.3. Design and Build an application program	80
4.4.4. Execute the application on the ViewPAC.....	84
4.5. Your First Program in VB.net	86
4.5.1. Create a new project	87
4.5.2. Add project reference for an application	89
4.5.3. Design and Build an application program	90
4.5.4. Execute the application on the ViewPAC.....	93
4.6. Your First Program in eMbedded Visual C++.....	95
4.6.1. Create a new Forms-Based project	96
4.6.2. Configure compiler options.....	101
4.6.3. Specify the path for project reference.....	102
4.6.4. Design and Build an application program	106
4.6.5. Execute the application program on ViewPAC	110

5. APIs and Demo References..... 111

- 5.1. Demo programs with C# 112
 - 5.1.1. C# Demo program for WinPAC Standard API..... 113
 - 5.1.2. C# Demo program for PAC IO API 115
 - 5.1.3. C# Demo program for ViewPAC Particular API..... 118
- 5.2. Demo Programs with eMbedded Visual C++ 120
 - 5.2.1. eVC Demo program for WinPAC Standard API 121
 - 5.2.2. eVC Demo program for PAC IO API 123
 - 5.2.3. eVC Demo program for ViewPAC Particular API 126

6. ViewPAC Updates..... 127

- 6.1. OS updates..... 128
 - 6.1.1. Updating the Boot Loader and the ViewPAC OS image from files..... 130
 - 6.1.2. Updating the ViewPAC OS image from eshell 136
- 6.2. SDKs Updates 142
 - 6.2.1. WinPAC SDK updates for C# or VB.net..... 143
 - 6.2.2. WinPAC SDK updates for eMbedded Visual C++..... 144

7. ViewPAC Download Center 145

Appendix A. I-8K and I-87K Modules..... 146

Appendix B. Application of RS-485 Network 147

- B.1. Basic RS-485 Network 148
- B.2. Daisy Chain RS-485 Network..... 149
- B.3. Star Type RS-485 Network..... 150

B.4. Random RS-485 Network	152
B.5. Master/Slaves Settings.....	153
B.5.1. ViewPAC as a Master (default).....	154
B.5.2. ViewPAC as a Slave:.....	155

Appendix C. Tips – How to157

C.1. How to add a user account to remote login the ViewPAC from PC	158
C.2.1. How to add a user account	159
C.2.2. How to Use telnet to remote login the ViewPAC from PC	161
C.2.3. How to remove the user from the login list.....	163
C.2. How to online debug ViewPAC.....	165
C.2.1. Debug ViewPAC programs in EVC++	166
C.2.2. Debug ViewPAC programs in Visual Studio 2005/2008	177
C.3. How to recompile WinCon programs.....	186
C.3.1. Compiler old programs which ran on Wincon 8x3x and 8x4x.....	187
C.3.2. Modify .vcp file to upgrade the old WinCon project	191
C.4. How to use the printer	192
C.4.1. How to use network printer	193
C.4.2. How to use printer via USB	196
C.5. How to use services tool	197

Appendix D. Revision History200

1. Introduction



ViewPAC combines WinPAC, graphic display and keypad in one unit. It equips a PXA270 CPU (520 MHz) running Windows CE.NET 5.0 operating system, various connectivity (USB, Ethernet, RS-232/485), 3 slots to expand I/O modules, 3.5"/5.7" TFT LCD and a rubber keypad.

Its operating system, Windows CE.NET 5.0, has many advantages, includes hard real-time capability, small core size, fast boot speed, interrupt handling at a deeper level, achievable deterministic control and low cost. Running Windows CE.NET 5.0 in the ViewPAC gives it the ability to run PC-based control software such as Visual Basic.NET, Visual C#, Embedded Visual C++, SCADA software, Soft PLC ...etc.

Compared with traditional IPC + PLC solutions, ViewPAC reduces overall system cost, space and gives you all the best features of IPC and PLC

1.1. Features

The ViewPAC offers the most comprehensive configuration and remote system upgrade solutions to meet specific application requirements. The following list shows the hardware and software features designed to simplify installation, configuration and application.

Software Features

- Windows CE .Net 5.0 Inside
- Easy Remote Maintenance via Ethernet
 1. FTP Server
 2. VCEP Software
- Built-In OPC Server: NAPOPC_CE5
 1. An OPC Server for SCADA Software
 2. Integrates Local/Remote I/O Modules via RS-232/485 or Ethernet
 3. Provides Library for eVC, C#, or VB.NET
 4. Supports Modbus and DCON Protocols
- Development Software
Visual Studio.NET 2005/2008, and eVC
- SDK/Demo Programs for C#, VB.NET & eVC

Hardware Features

- PXA 270 CPU (32-bit & 520 MHz)
- IP65 Compliant Front Panel
- 3.5"/5.7" TFT LCD (5.7" LCD is with Touch Panel)
- Rubber Keypad with 24/6 Keys
- Audio with MIC-In and Line-Out
- 64-bit Hardware Serial Number for Software Protection
- 3 Slots for High Profile I/O Modules
- Rich I/O Expansion Ability
 1. Ethernet
 2. RS-232/422/485
 3. FRnet
 4. CAN bus
- Dual Battery Backup SRAM (512 KB)
- One Ethernet Port
- 2 Serial Ports (RS-232, RS-485)
- Operating Temperature: -20 ~ +70 °C

1.2. Specifications

The table below summarizes the specifications of the ViewPAC.

System Software	VP-23W1	VP-25W1
OS	Windows CE .NET 5.0	
.Net Compact Framework	2.0	
Embedded Service	FTP server, Web server (supports VB script, JAVA script), Embedded SQL server	
SDK Provided	DII for eVC, DII for Visual Studio.Net 2005/2008	

CPU Module	VP-23W1	VP-25W1
CPU	PXA270 or compatible (32-bit and 520 MHz)	
SDRAM	128 MB	
Dual Battery Backup SRAM	512 KB (for 5 years data retention)	
Flash	96 MB (64 MB for OS image, 31 MB for built-in Flash disk, 1 MB for registry)	
EEPROM	16 KB (data retention: 40 years; 1,000,000 erase/write cycles)	
Expansion Flash Memory	microSD socket with one 1 GB microSD card (support up to 16 GB microSDHC card)	
RTC (Real Time Clock)	Provide seconds, minutes, hours, date of week/month; month and year, valid from 1980 to 2079	
64-bit Hardware Serial Number	Yes	
Dual Watchdog Timer	Yes (0.8 second)	
Rotary Switch	Yes (0 ~ 9)	

I/O Expansion Slots	VP-23W1	VP-25W1
Slot Number	3 (for high profile I-8K and I-87K modules only)	
Hot Swap *Will be available	Yes (for high profile I-87K modules only)	

Communication Interface	VP-23W1	VP-25W1
Ethernet Port	RJ45 * 1, 10/100 Base-TX (Auto-negotiating, Auto MDI/MDIX, LED indicators)	
USB 1.1 (host)	1	
COM0	Internal communication with the high profile I-87K series modules in slots	
COM2	RS-485 (D2+, D2-; self-tuner ASIC inside); 2500 V _{DC} isolated	
COM3	RS-232 (RxD, TxD, CTS, RTS, DSR, DTR, CD, RI and GND); Non-isolated	

Main Machine Interface	VP-23W1	VP-25W1
LCD	3.5" TFT (Resolution 320 x 240)	5.7" TFT (Resolution 640 x 480)
Touch Panel	-	Yes
Rubber Keypad	24 Keys	6 Keys
Audio	Microphone-In and Earphone-Out	
LED Indicators	3 Dual-Color LEDs (PWR, RUN, LAN1, L1, L2, L3; L1 ~ L3 for user programmable)	

Environmental	VP-23W1	VP-25W1
Operating Temperature	-20 ~ +70 °C	
Storage Temperature	-30 ~ +80 °C	
Ambient Relative Humidity	5 ~ 90% RH, non-condensing	

Power	VP-23W1	VP-25W1
Input Range	+10 V ~ +30 V _{DC}	
Isolation	1 kV	
Capacity	2.5 A, 5 V supply to I/O expansion slots	
Consumption	7.2 W (0.3 A @ 24 V _{DC})	

Mechanical	VP-23W1	VP-25W1
Dimension (W x D x H)	182 mm x 158 mm x 125 mm	
Ingress Protection	Front panel: IP65	
Installation	Panel mounting	

1.3. Overview

The ViewPAC contains several interfaces and peripherals that can be integrated with external systems. Here is an overview of the components and its descriptions. The details of these items are as follows:



1. LED Indicators

The ViewPAC contains three LED indicators that are located on the top of the unit.

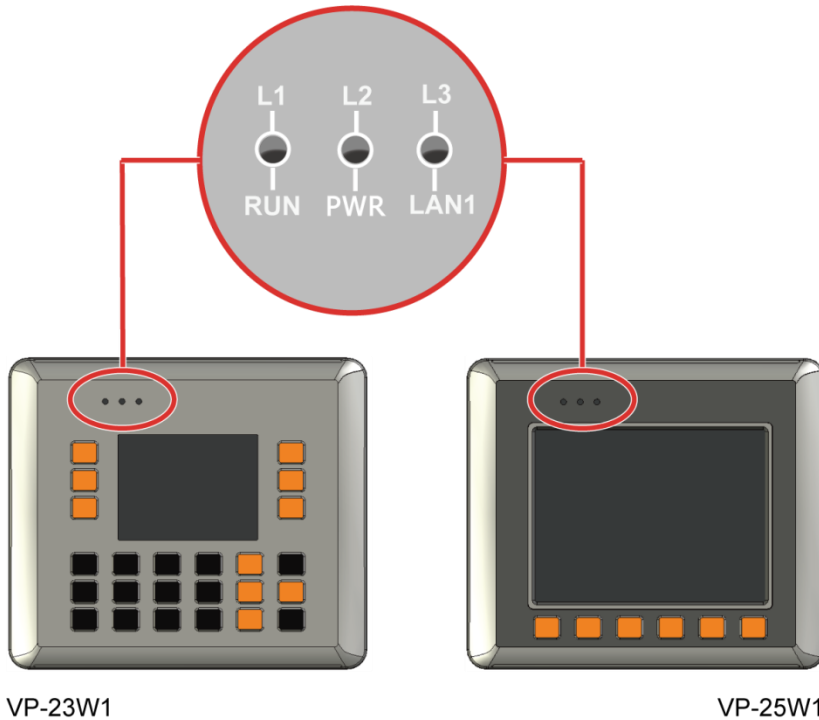

The LED indicators can be used to indicate the power status, OS status and Link/Activity, and are described as follows:

LED Indicator	State (Color)	Meaning
L1/L2/L3	ON (Red)	Controlled via a program
	OFF	Controlled via a program
RUN	ON (Green)	The OS is on
	Blink	The System_disk is being formatted or defragmented
PWR	ON (Green)	The Power is ON
	OFF	The Power is OFF
LAN1	ON (Green)	The Link is active
	OFF	The Link is inactive
	Blink (Green)	Network activity

2. LCM

The LCM size of the VP-23W1 is 3.5" 320 x 240.

The LCM size of the VP-25W1 is 5.7" 640 x 480.

3. Keypad

The keypad on the VP-2000 is used to provide support for keyboard input.

The F1 ~ F6 function keys can also be programmed by the user.

4. Micro SD Socket

The ViewPAC also contains a Micro SD socket that can be used to increase memory capacity to 16 GB.

5. Rotary Switch

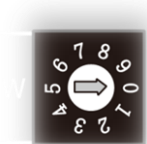

The Rotary Switch is an operating mode selector switch which provides seven functions related to the selection of the operating mode and authorization control for the VP-2000.

For more information about the operating mode, please refer to “section 2.2. Configuring the Boot Mode”

6. I/O Expansion Slots

The VP-2000 contains three I/O expansion slots that are used to serve in the local and remote expansion.

7. Power Input and Frame Ground

The VP-2000 contains a power terminal that is used to provide power for its operation.

The terminal block contains 3 pins and the pin assignments are as follows:

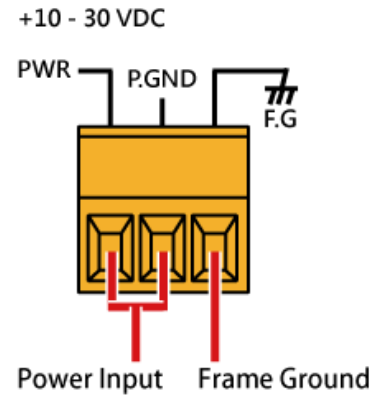

8. Waterproof Ethernet Port

The VP-2000 contains an Ethernet port that is waterproof to protect the device from external contaminants.

9. COM2 (RS-485)

The COM2 port provides a connection to external RS-485 devices. The COM2 has 2 pins, as follows:

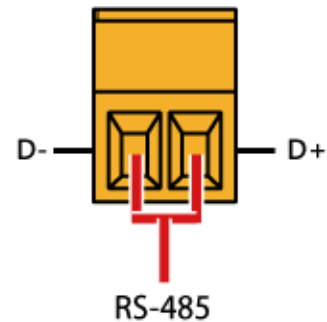

10. COM3 (RS-232)

Port Type: Male

Baud Rate: 115200, 57600, 38400, 19200,
9600, 4800, 2400, 1200 bps

Data Bits: 5, 6, 7, 8

Parity: None, Even, Odd, Mark (Always 1), Space
(Always 0)

Stop Bits: 1, 2

FIFO: 16 bytes

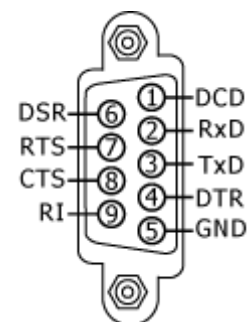

Tips & Warnings



The table below shows the data bit of each COM port and their corresponding stop bit.

Word Length	Number of Stop Bits
5, 6, 7, 8	1
5	1.5
6, 7, 8	2

11. USB Port

The VP-2000 contains a USB port that allows support for USB devices such as mouse, keyboard or an external USB hard drive.

12. Microphone and Earphone Jacks

The VP-2000 contains a microphone and an earphone jack to allow the input and output of audio system.

1.4. Dimensions

The diagrams below provide the dimensions of the standard VP-2000 family to use in defining your enclosure specifications. Remember to leave room for potential expansion if you are using other components in your system.

All dimensions in millimeter.

VP-23W1

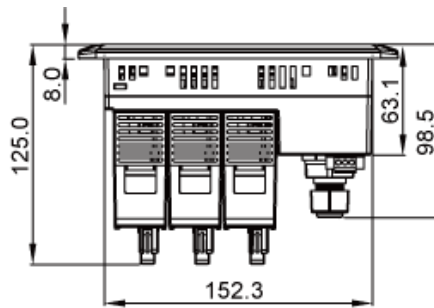

Top View

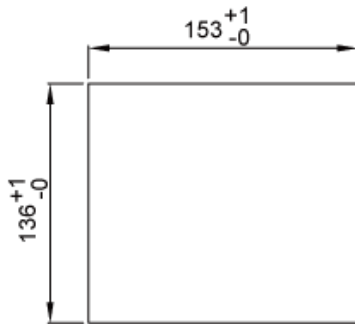

Recommended Panel Cut-Out

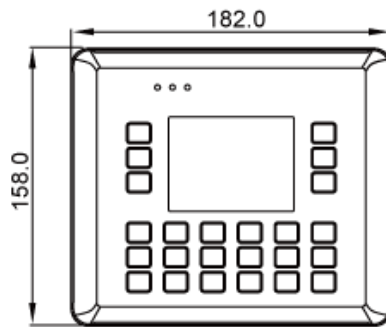

Front View

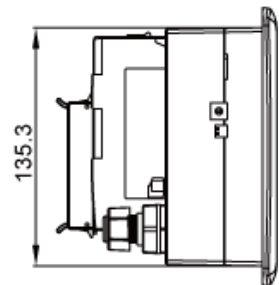

Right Side View

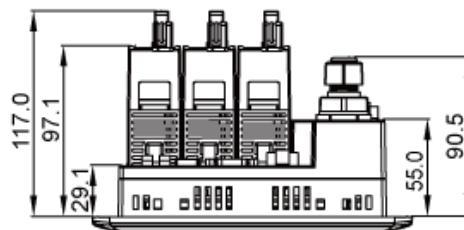

Bottom View

VP-25W1

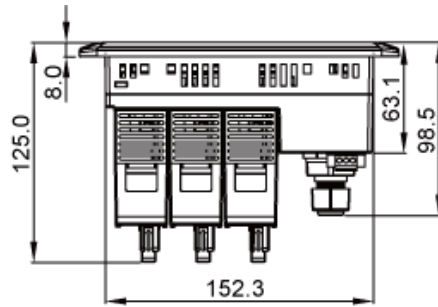

Top View

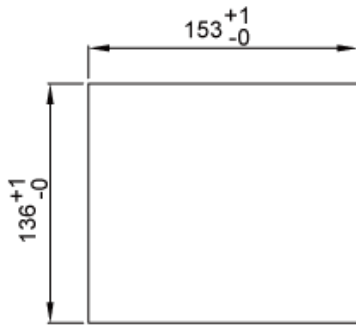

Recommended Panel Cut-Out

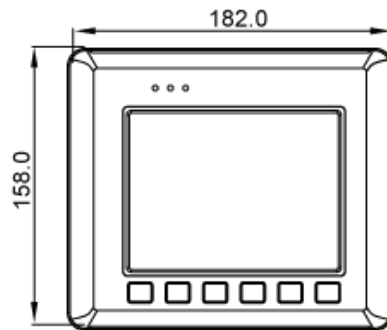

Front View

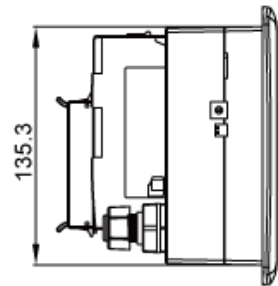

Right Side View

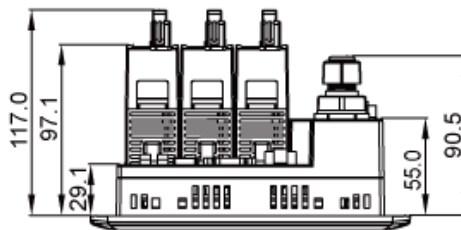

Bottom View

1.5. Companion CD

This section describes the content of the companion CD, which provides the resource, tool kit, software and documentation related to the ViewPAC.

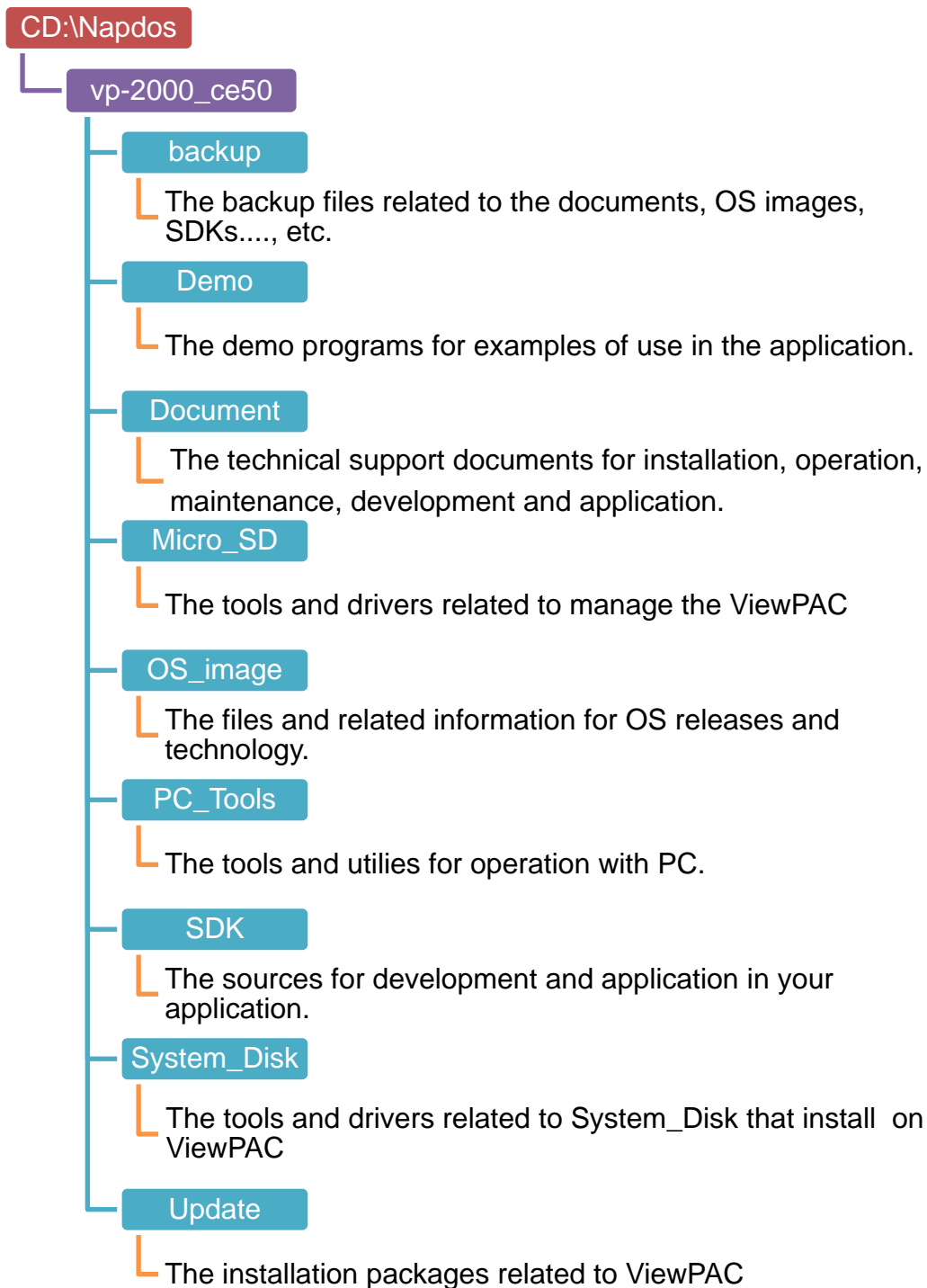

2. Getting Started

This chapter provides a guided tour that describes the steps needed to download, install, configure, and run the basic procedures for user working with the ViewPAC for the first time.

Before starting any task, please check the package contents. If any of the following package contents are missing or damaged, contact your dealer, or distributor.

In addition to this guide, the package includes the following items:



VP-23W1/VP-25W1 & Touch Pen



Expansion I/O Socket * 3



Quick Start Guide



Software Utility CD



1 GB Micro SD Card



RJ-45 Waterproofing Kit



Panel Clip * 4



Screw Driver

2.1. Mounting the Hardware

Before you work with the ViewPAC, you should have a basic understanding of hardware specification, such as the dimensions, the usable input-voltage range of the power supply, and the type of communication interfaces.

For more information about the hardware details, see section 1.2., “Specifications.”

For more information about the hardware dimensions, see section 1.4., “Dimension.”

2.1.1. Removing the Slot Cover

The ViewPAC has a slot cover to protect the internal components from damage during shipping. Before starting any installation, please first remove the slot cover.

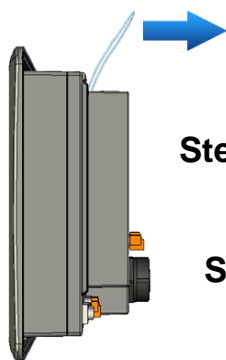

Step 1: Hold the top of ViewPAC

Step 2: Pull the plastic wrap

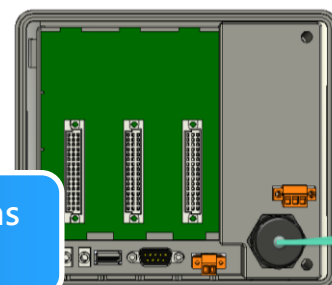

The slot cover has been removed

2.1.2. Installing Expansion I/O Sockets

The case (a socket and a top case) is included in the package. Before inserting the I/O modules talling the I/O modules in

If you do not expand the I/O module full, please keep the top case of the unused slot to protect the backplane from dirt, dust and damage from foreign objects.

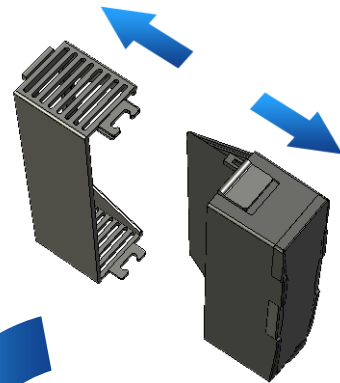

Step 1: Take the socket out from the case

Step 2: Padlock the bottom of the socket into the ViewPAC

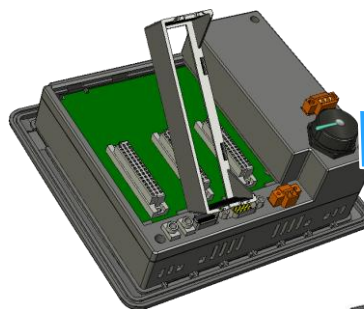

Step 2: Slide the socket into the ViewPAC until it clicks

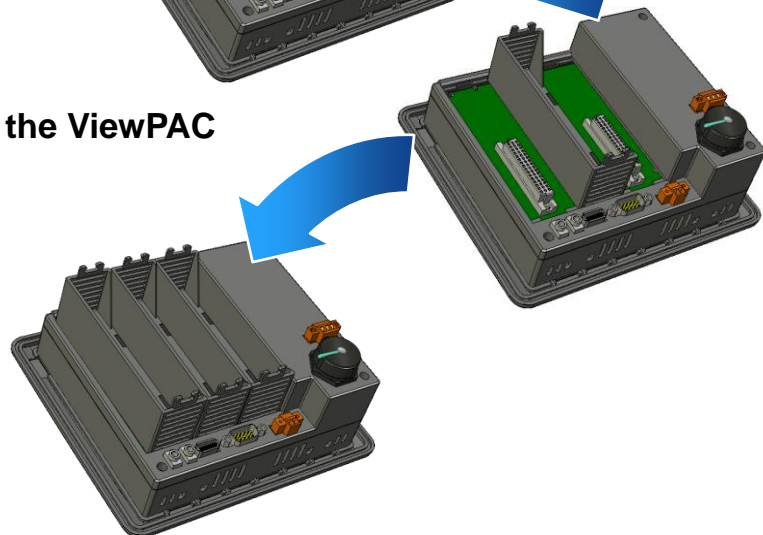

2.1.3. Installing the I/O Modules

ViewPAC supports various types of I/O expansion modules for interfacing many different field devices.

For more information about I/O expansion modules, please refer to:

http://www.icpdas.com/products/PAC/winpac/io_support_list.htm

Step 1: Hold the I/O module vertically and align the socket

Step 2: Carefully press the I/O module onto the socket

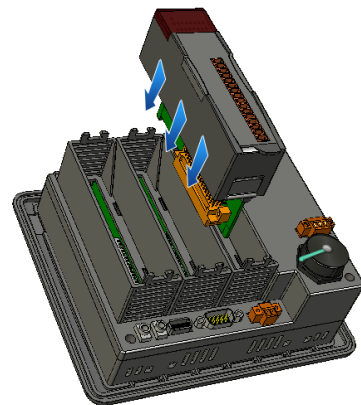

Tips & Warnings



If you do not expand the I/O module full, please keep the top case of the unused slot to protect the backplane from dirt, dust and damage from foreign objects.

Step 3: Read the relevant documentation



For high profile I-8K series:

CD:\Napdos\io_module

http://www.icpdas.com/products/PAC/winpac/io_support_list.htm

For high profile I-87K series:

CD:\Napdos\io_module

http://www.icpdas.com/products/PAC/winpac/io_support_list.htm

Step 4 Wire the I/O channels

All documents include the I/O module specifications, pin assignments and wiring connections.

For example, Pin Assignments and Wiring connections for the I-87054W module are as follows:

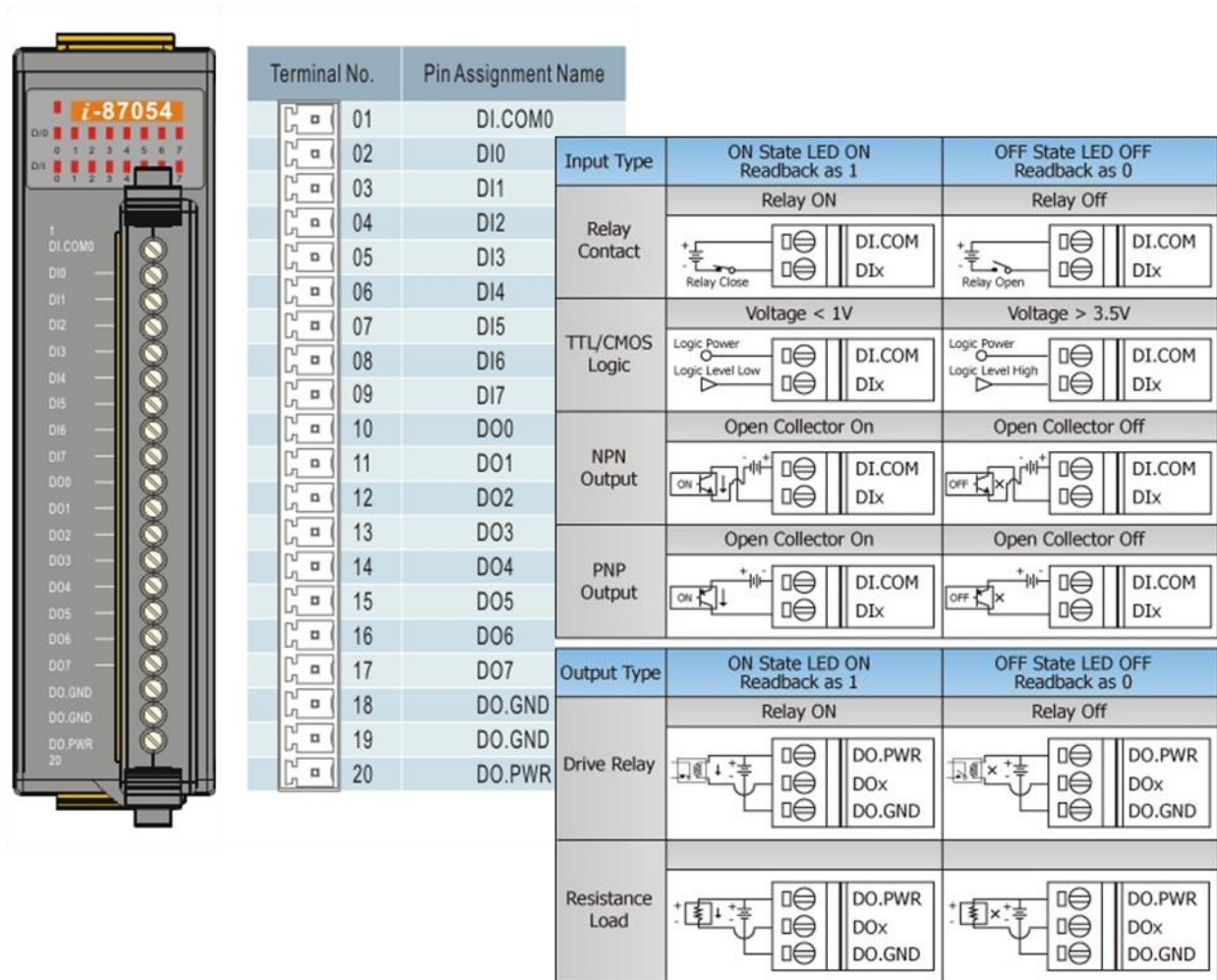

Tips & Warnings



It is recommended that the power to the ViewPAC is switched off when wiring the I/O module which are plugging in the ViewPAC slots.

2.1.4. Mounting the Waterproof

The ViewPAC provides an IP67 waterproof connector to ch consists of the following components plugged in RJ-45 cable.





2.1.5. Mounting the ViewPAC

The ViewPAC can be mounted on a panel of maximum thickness 12 mm. Adequate access space can be available at the rear of the instrument panel for wiring and servicing purposes.

Tips & Warnings



To ensure proper ventilation for your ViewPAC, leave a minimum of 50mm space between the top and bottom edges of the ViewPAC and the enclosure panels.

Panel thickness up to 12 mm

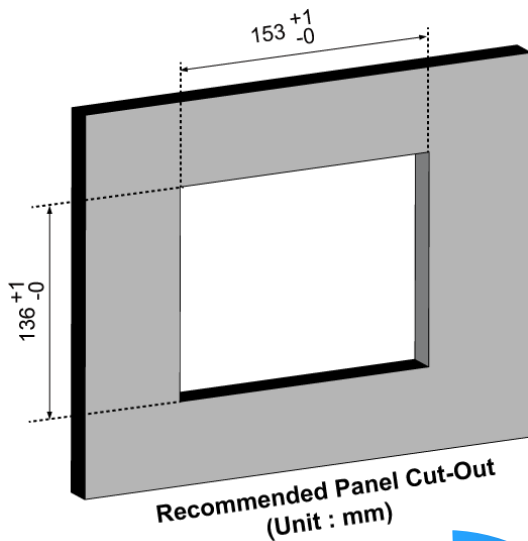
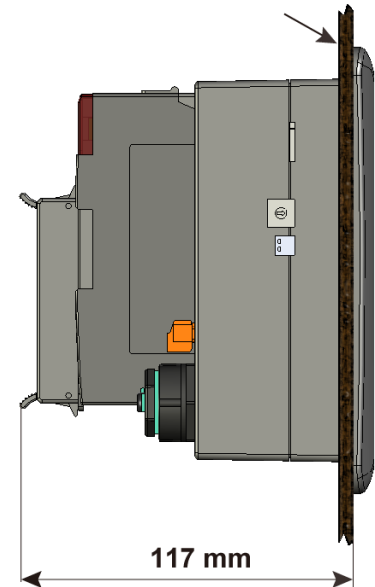

Step 1: Prepare the panel and cut the hole to the specified size

Step 2: Attach the ViewPAC to the cut-out hole

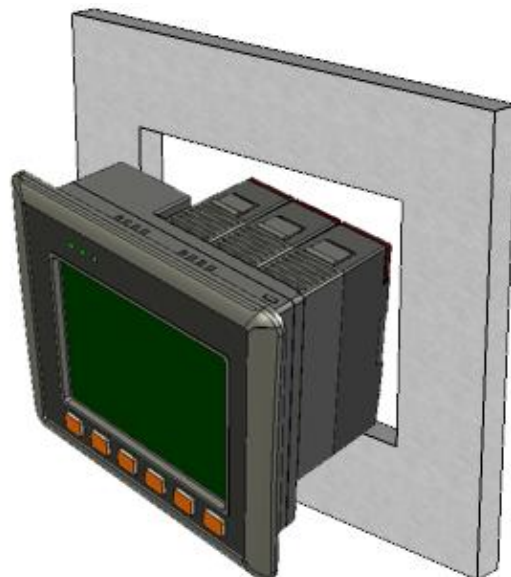

Step 3: Insert the panel mounting clips into the upper and lower ventilation holes

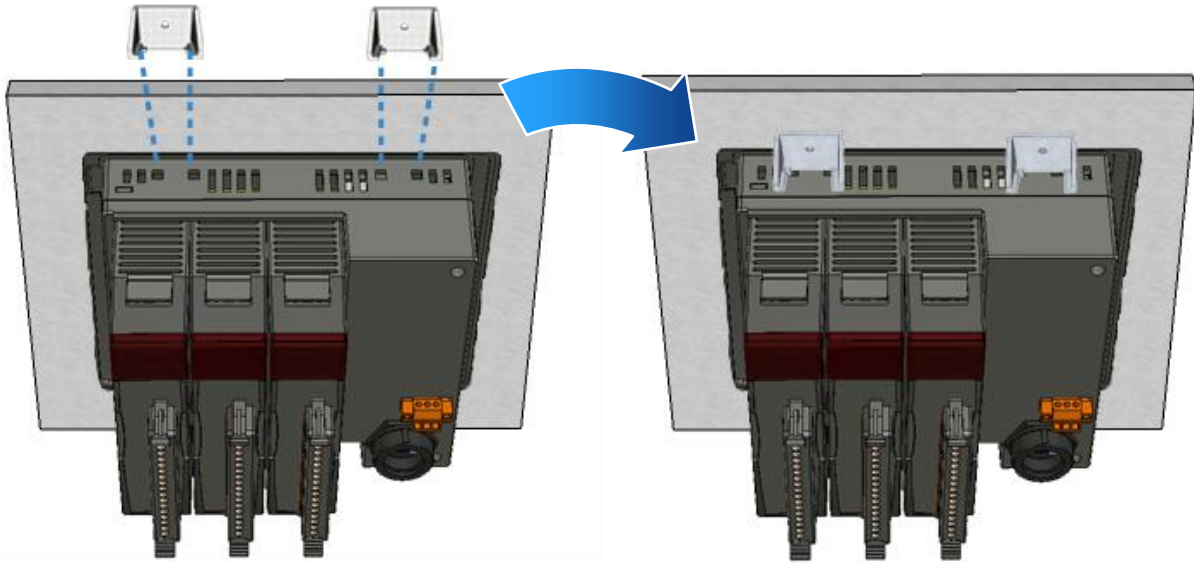

Step 4: Screw the panel mounting clips to the panel

Mounting Screw :
M 4 x 35 L

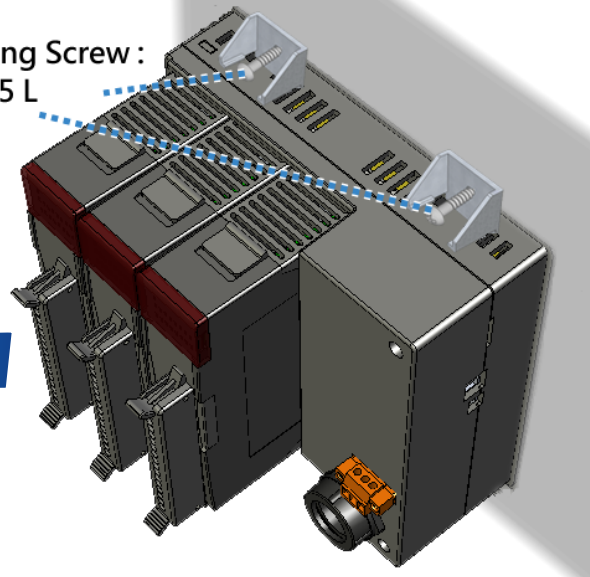
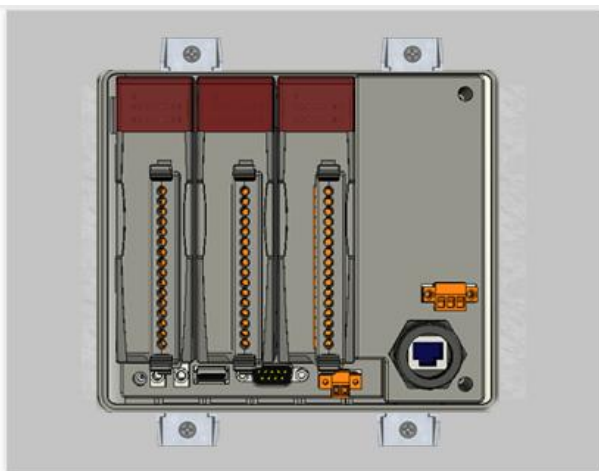

2.1.6. Deploying a Basic ViewPAC Application

The ViewPAC provides a variety of communication interface to suit a range of applications. Here is a simple application for using the ViewPAC that is shown below.

Step 1: Connect the positive terminal (+) of the power supply to the terminal PWR and the negative terminal (-) of the power supply to the P.GND

Tips & Warnings



The input range of power supply is +10 ~ +30 VDC

Step 2: Connect PC to the Ethernet port

Step 3: Connect the USB keyboard to the USB port

Step 4: Connect the audio to the microphone and earphone jack

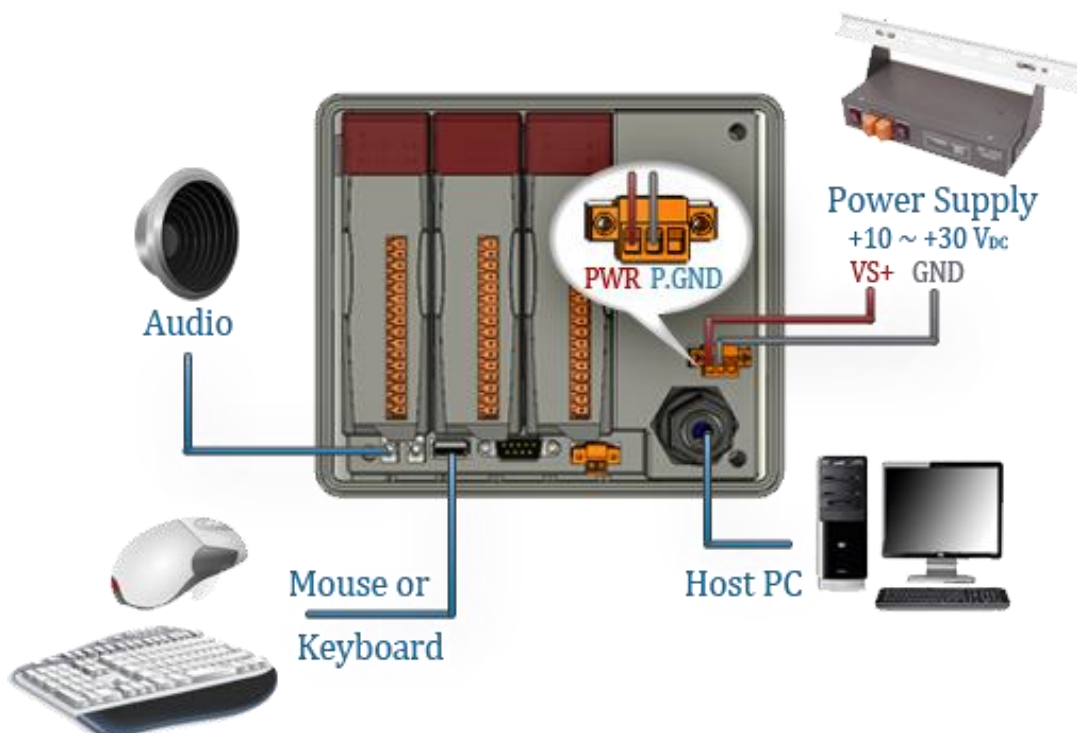

2.2. Configuring the Boot Mode

The ViewPAC has five operating modes that can be determined through a rotary switch.

The table below lists the operation mode selection.

	Rotary switch position	Modes of operation
	0	Normal mode (Default)
	1	Safe mode
	2	Debug mode
	3	OS update mode
	4	Development mode
	5	DCON_CE
	6	VCEP
	7 ~ 9	(For user)

Normal Mode (Default)

Normal mode is the default mode of operation and the one you will use most of the time. Use this mode for more tasks and configurations. Programs also are executed in this mode.

Safe Mode

Safe mode is a trouble shooting. The mode loads the minimum required device drivers and system services to boot the ViewPAC.

If you have malicious software or a program caused the ViewPAC cannot be boot or run the normal mode, you can boot in safe mode to solve the problem.

Tips & Warnings



In normal mode, if the new settings are not saved when you change and save the settings using the ViewPAC Utility, to solve this problem, perform the following steps:

Step 1: Restart the ViewPAC in safe mode

Turn the rotary switch to “1”, and then restart the ViewPAC.



Step 2: Start the ViewPAC Utility to restore the default settings

Start the ViewPAC Utility, and then click the “Restore Default Settings” command and “Save” command from the “File” menu



Step 3: Restart the ViewPAC in normal mode

Turn the rotary switch to “0”, and then restart the ViewPAC.

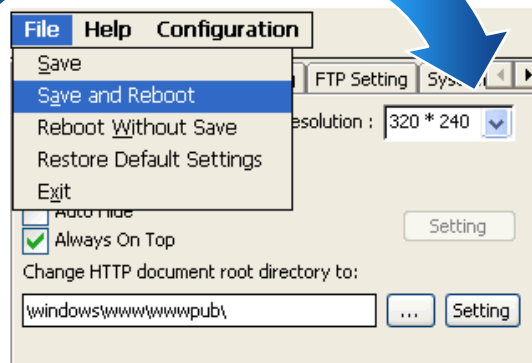

Debug Mode

Debug mode is a special environment in which program debug functions can be used in addition to normal system functions.

Debug mode is unsupported.

OS Update Mode

OS update mode is a way used to update OS. To update the ViewPAC OS image, please refer to “6.1. OS updates”

DCON_CE Mode

This mode is the same as Normal mode. Besides, DCON_CE.exe will be run automatically after booting

Tips & Warnings



DCON_CE.exe must be placed on the \System_Disk\Tools\DCON_CE, or else DCON_CE.exe cannot be run automatically after booting.

VCEP Mode

This mode is the same as Normal mode. Besides, VCEP.exe will be run automatically after booting.

Tips & Warnings



VCEP.exe must be placed on the \System_Disk\Tools\VCEP or else VCEP.exe cannot be run automatically after booting.

User Mode

Rotary switch position 7, 8, 9 are reserved for user's applications.

When ViewPAC is boot with one of these rotary switch positions, it is boot at normal mode. User's application can check the rotary switch position to run at different mode.

2.3. Testing the ViewPAC

VP-23W1:

ViewPAC combines WinPAC, graphic display and keypad dial in one unit. The ViewPAC Quick Test is a toolkit used to check out the ViewPAC particular function compared with WinPAC.



Audio Options:

Play Audio

Play Audio button is used to check the audio output.

Buzzer Options:

Play Buzzer

Play Buzzer button is used to check the buzzer.

LED Options:

These buttons are used to check LEDs sign.

KeyPAD Option:

Checkboxes are used to check the KeyPAD.

Text field is used to check the input format.

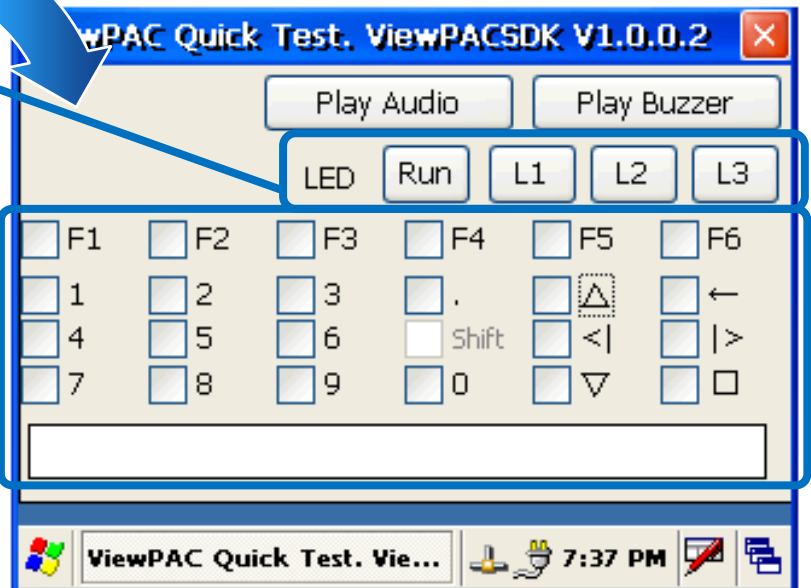

Tips & Warnings



The shift key is a modifier key used to enter alternate upper letters or characters.

VP-25W1:

ViewPAC combines WinPAC, graphic display and keypad dial in one unit. The ViewPAC Quick Test is a toolkit used to check out the ViewPAC particular function compared with WinPAC.



Audio Options:

Play Audio

Play Audio button is used to check the audio output.

Buzzer Options:

Play Buzzer

Play Buzzer button is used to check the buzzer.

LED Options:

These buttons are used to check LEDs sign.

KeyPAD Option:

Checkboxes are used to check the KeyPAD.

LCD Backlight Options:

The slider is used to check the LCD Backlight.

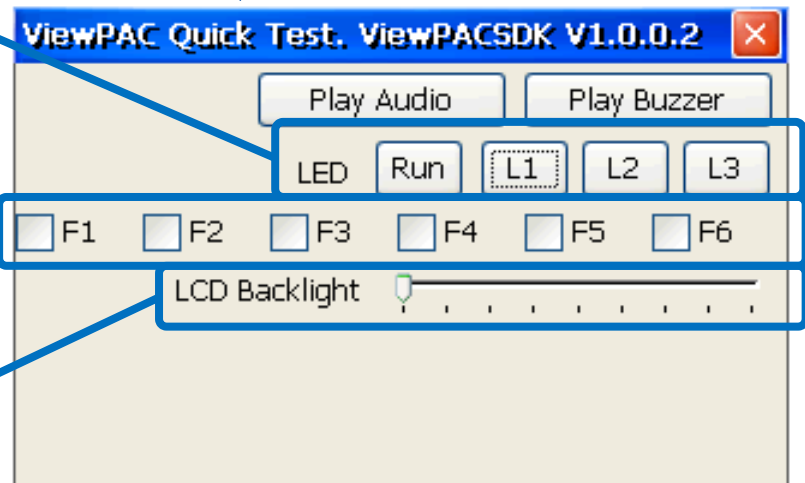

2.4. Using ViewPAC Utility to manage the ViewPAC

The ViewPAC Utility is a toolkit used to quickly control and manage the ViewPAC.

For more detailed information on ViewPAC Utility applications, please refer to “3.5. ViewPAC Utility”

Step 1: Run the ViewPAC Utility located on desktop



Step 2: Configure IP address (DHCP), FTP Server, Auto Execution files..., etc

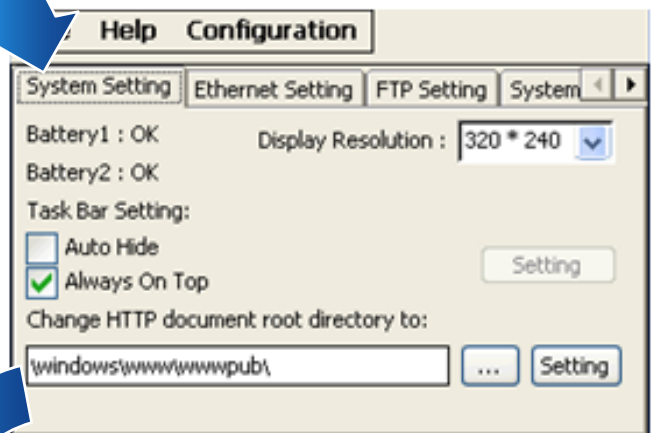

Step 3: Save and Reboot the ViewPAC

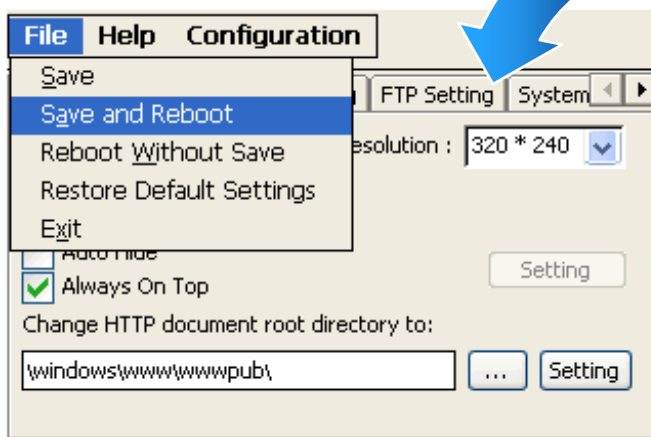

2.5. Using DCON Utility to Configure the I/O Modules

DCON Utility is a tool kit used to quickly control and manage expansion I/O modules with DCON protocol.

Step 1: Run the DCON firmware on the ViewPAC controller



The DCON firmware is located at:
\\System_Disk\tools\DCON_CE\

Step 2: Run the DCON Utility on the host PC

The DCON Utility can be obtained from:

CD:\Napdos\vp-2000_ce50\PC_Tools\DCON_UTILITY\

http://ftp.icpdas.com/pub/cd/winpac/napdos/vp-2000_ce50/pc_tools/dcon_utility/



Step 3: Click the WIN CE button



Step 4: On the WINCE device connection, enter the IP address of the ViewPAC to search the I-87K series expansion I/O modules



Step 5: It will display a list of I-87K series expansion I/O modules, then select the module name that you want to configure

module	Address	Baudrate	Checksum	format	Status	Description
WinCon8000	1(1)	115200	Disable	N,8,1		WinPAC8000 System(DCON)
xxxxxx	S0	115200	Disable			[Parallel bus module] or [None]
xxxxxx	S1	115200	Disable			[Parallel bus module] or [None]
xxxxxx	S2	115200	Disable			[Parallel bus module] or [None]
xxxxxx	S3	115200	Disable			[Parallel bus module] or [None]
xxxxxx	S4	115200	Disable			[Parallel bus module] or [None]
xxxxxx	S5	115200	Disable			[Parallel bus module] or [None]
xxxxxx	S6	115200	Disable			[Parallel bus module] or [None]
xxxxxx	S7	115200	Disable			[Parallel bus module] or [None]

2.6. Using Backup Utility to back up the settings and files

After saving the configuration settings for a ViewPAC device following the first use, it is recommended to use the Backup utility to back up all the data (settings and files).

Step 1: Run the Backup Utility on the ViewPAC

The DCON firmware is located at:
\\System_Disk\\tools\\Backup_utility\\

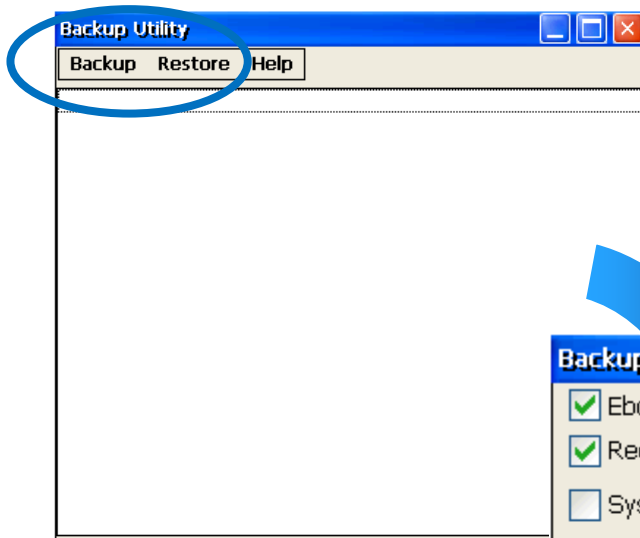

Step 2: Click the Backup menu

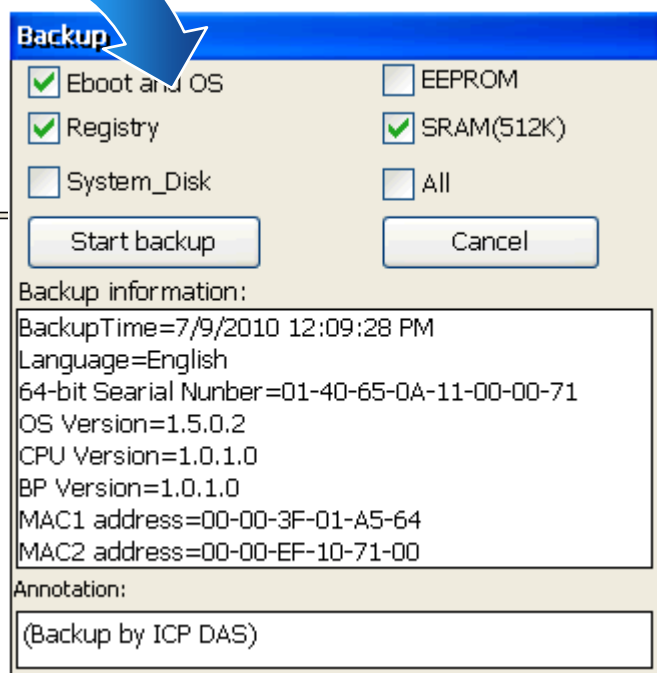

Step 3: Select the options that you want to backup, enter text annotations and then click the Start backup button

Step 4: Confirm the backup options and then click Yes button

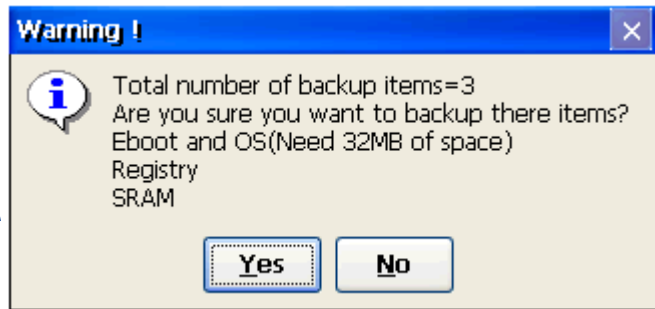

Step 5: Choose the folder that you want to save backup file and click the Ok button

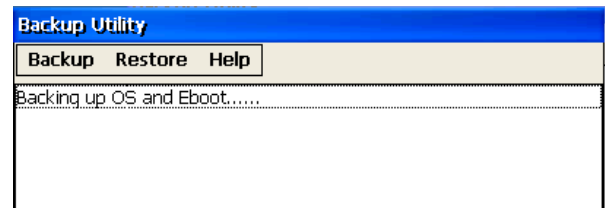

Step 6: Wait for process to finish

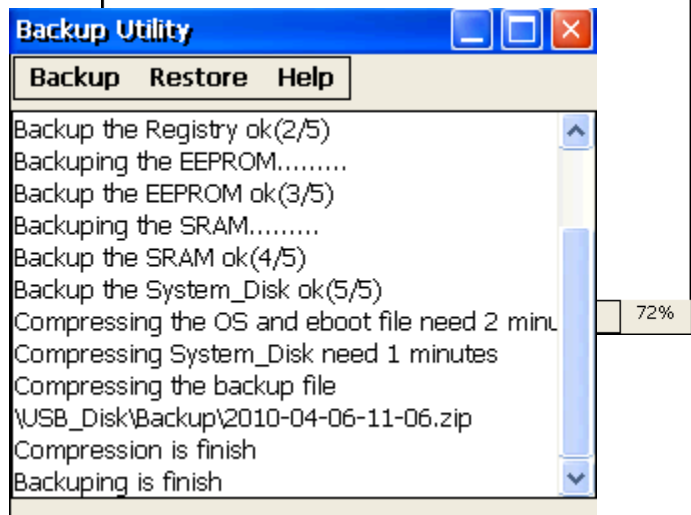

2.7. A caution about using System_Disk

The System_disk is an authoritative storage device, but is not suitable for frequent copying and deleting of files and is only suitable for storing important files that are not changed frequently.

If files are copied and deleted frequently, the system will automatically perform a System_Disk defragment action, which will consume the total resources of the CPU and cause the OS not to function correctly.

When the OS System_Disk defragment action is being performed, the run LED will blink and the defragment action icon will show in the system tray in the bottom right-hand of the pc screen.

Note: Do not power off the WinPAC while the defragment is being performed.

Tips & Warnings



Don not power off the WinPAC while the defragment is being performed.

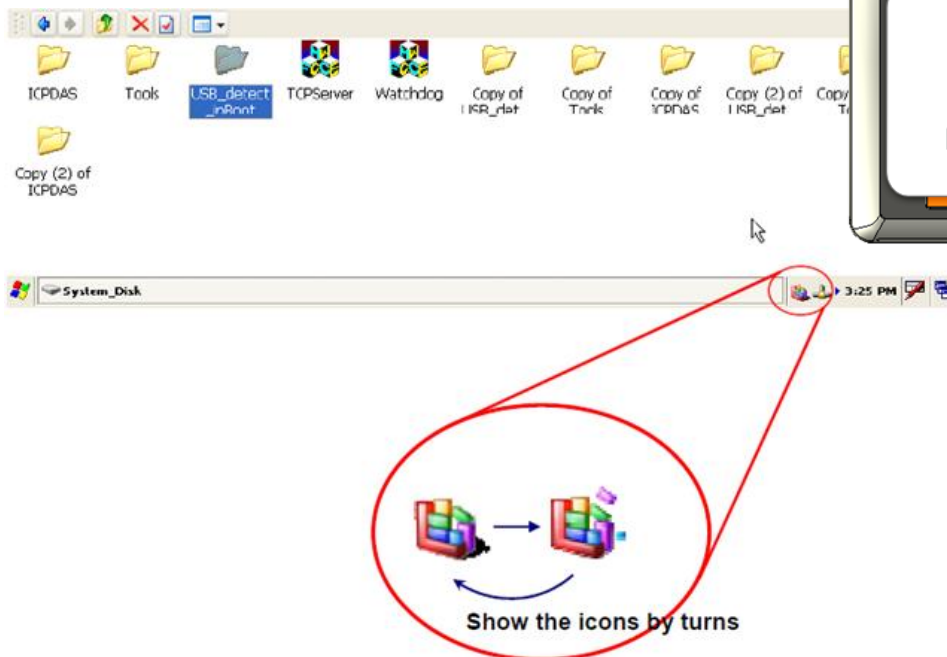

3. Tools and Tasks

This chapter briefly describes the functions of the ViewPAC software toolkits.

Following tools has been installed on the ViewPAC.

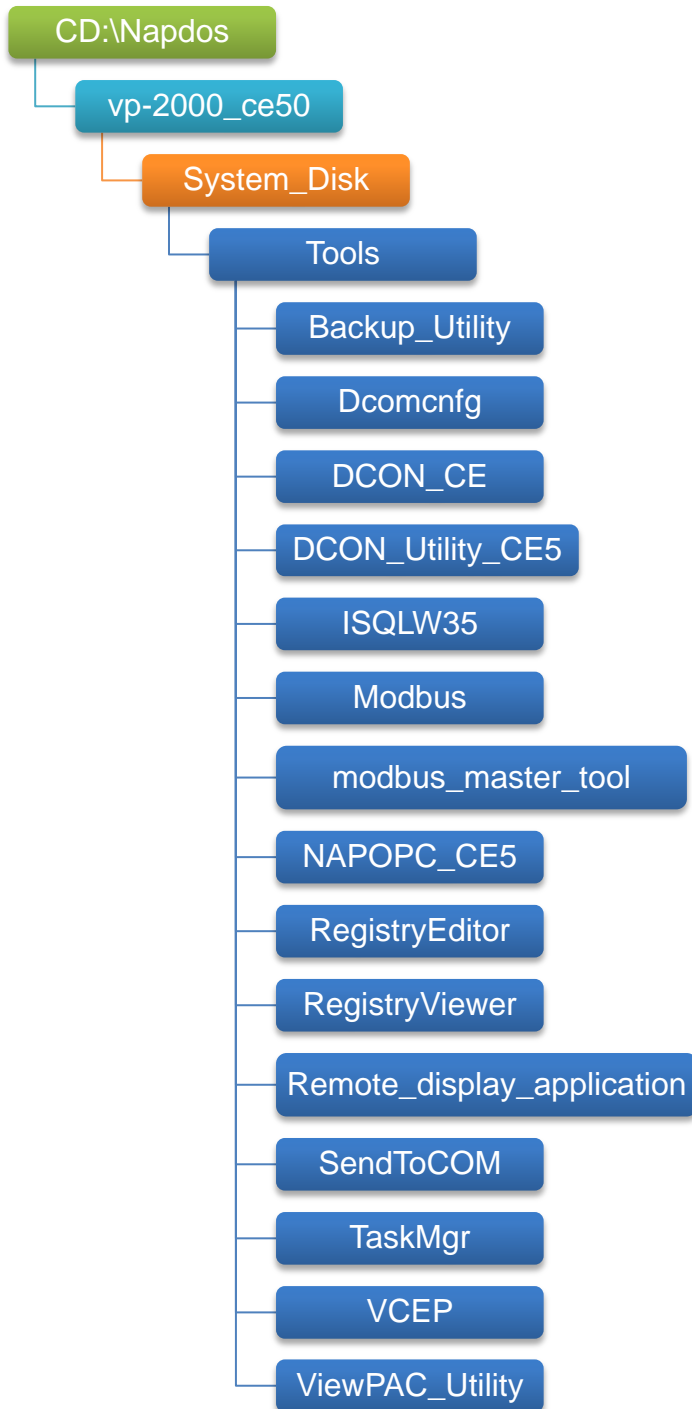

• **DCON_CE**

With Host PC running the DCON Utility, on the ViewPAC, the DCON_CE program allows user to view and monitor the status of the DCON Utility.

• **ISQLW35**

The ISQLW35 implements SQL server compact 3.5 Query Analyzer.

• **Modbus**

The Modbus provides various applications of Modbus protocol for configuring the ViewPAC.

• **NAPOPC_CE5**

NAPOPC_CE5 is an integrated omnibus software package, it allows user to quickly establish a DCS control system.

For more information about the NAPOPC_CE5, please refer to “3.2. NAPOPC_CE5”.

• **RegistryViewer**

The Registry Viewer allows user to view the registry value of Windows CE Operating System.

• **Remote display application**

The remote display application allows user to view the display remotely of the ViewPAC on a Host PC.

• **SendToCOM**

The SendToCOM allows user to send/receive data to/from the expansion module via serial port.

• **TaskMgr**

The TaskMgr provides details about programs and processes running on the ViewPAC.

• **VCEP**

The VCEP allows user to manage the ViewPAC remotely on a Host PC.
For more information about the VCEP, please refer to “3.4. VCEP (Virtual CE Pro)”.

• **ViewPAC Utility**

The ViewPAC Utility provides various useful functions such as configuring Ethernet settings, monitoring system settings and FTP services .etc for easy and quick management.

For more information about the ViewPAC Utility, please refer to “3.5. ViewPAC Utility”.

3.1. DCON Utility

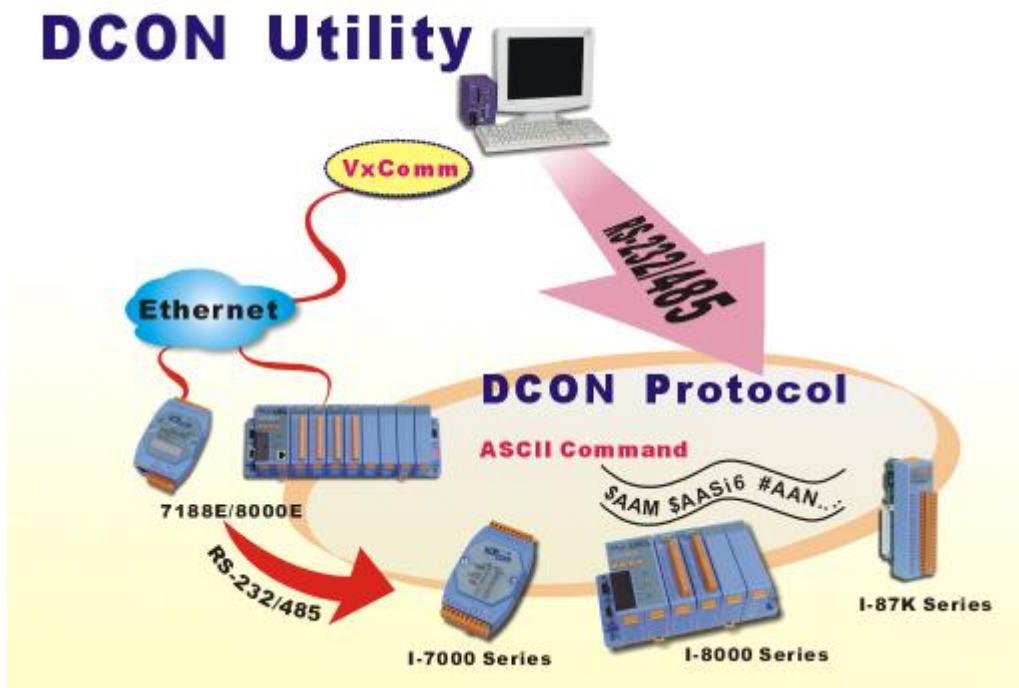

The DCON Utility is a tool kit that help user search the network, easily to Configure the I/O modules and test the I/O status via the serial port (RS-232/485) or Ethernet port (using virtual com port). It supports not only the DCON Protocol I/O modules but also the M Series I/O Modules (Modbus RTU M-7K, M-87K and will support Modbus ASCII M-87K) now.

For more detailed information on ViewPAC Utility applications, please refer to “2.5. Using DCON Utility to configure the I/O modules”

3.2. NAPOPC_CE5



NAPOPC_CE5 DA Server is a free OPC DA Server (The "OPC" stands for "OLE for Process Control" and the "DA" stands for "Data Access") working on WinPAC, ViewPAC & WinCon controllers provided by ICP DAS Ltd. The first standard (originally called simply the OPC Specification and now called the Data Access Specification)

resulted from the collaboration of a number of leading worldwide automation suppliers working in cooperation with Microsoft. Originally based on Microsoft's OLE COM (component object model) and DCOM (distributed component object model) technologies, the specification defined a standard set of objects, interfaces and methods for use in process control and manufacturing automation applications to facilitate interoperability. NAPOPC_CE5 DA Server integrates OPC, Modbus TCP Slave and Modbus RTU Slave three kind Slave services, as well as integrates Modbus TCP Master, Modbus RTU Master and DCON three kind Master communication protocols. It also provides one advanced function "Rule Script" for use in the I/O integration and transformation, and some conditional Logic operation.

Any version before 2.1.0 of the NAPOPC_CE5 was named "Quicker"

3.3. SendToCOM

The SendToCOM uses the serial port to communicate with expansion module. To use the SendToCOM, you can send data to expansion module through the serial port, and receive data from other device through the serial port.

For more information about these commands for communicating with expansion module, please refer to:

CD:\Napdos\io_module\87k_high_profile_modules.htm

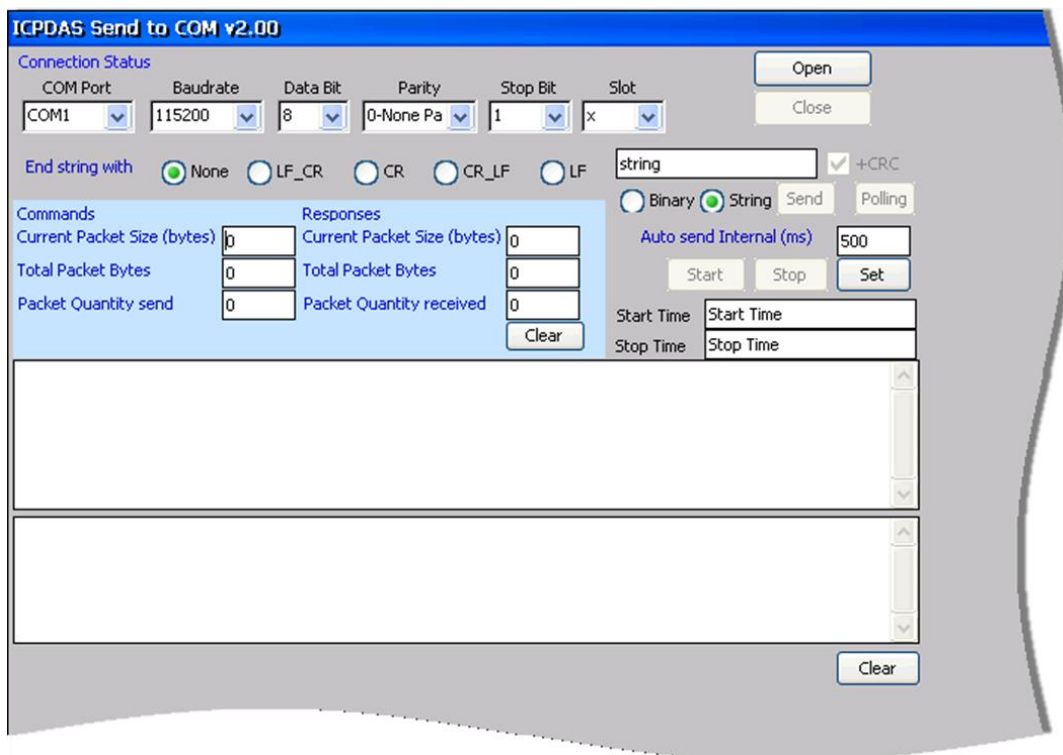

3.4. VCEP



ICPDAS VCEP is designed for managing your ViewPAC anywhere. No matter where you are, ICPDAS VCEP provides a convenient environment on the Desktop PC and allows you control your ViewPAC remotely.

ICPDAS VCEP is composed of two main components:
The "Server" which runs on ViewPAC.
The "Client" which runs on a Desktop PC.

Once a connection is established between the client and server (initiated by the client), the client will periodically send requests for screen updates and send mouse/key click information to the server to simulate. Each video frame is inter-compressed against the previous frame and then intra-compressed with a modified LZW scheme to minimize the amount of data transmitted from server to client.

For more detailed information on VCEP application, please refer to http://www.icpdas.com/products/PAC/wincon-8000/wincon_VirtualCE.htm

3.5. ViewPAC Utility

The ViewPAC Utility is a tool which is designed to quickly control and management the ViewPAC.

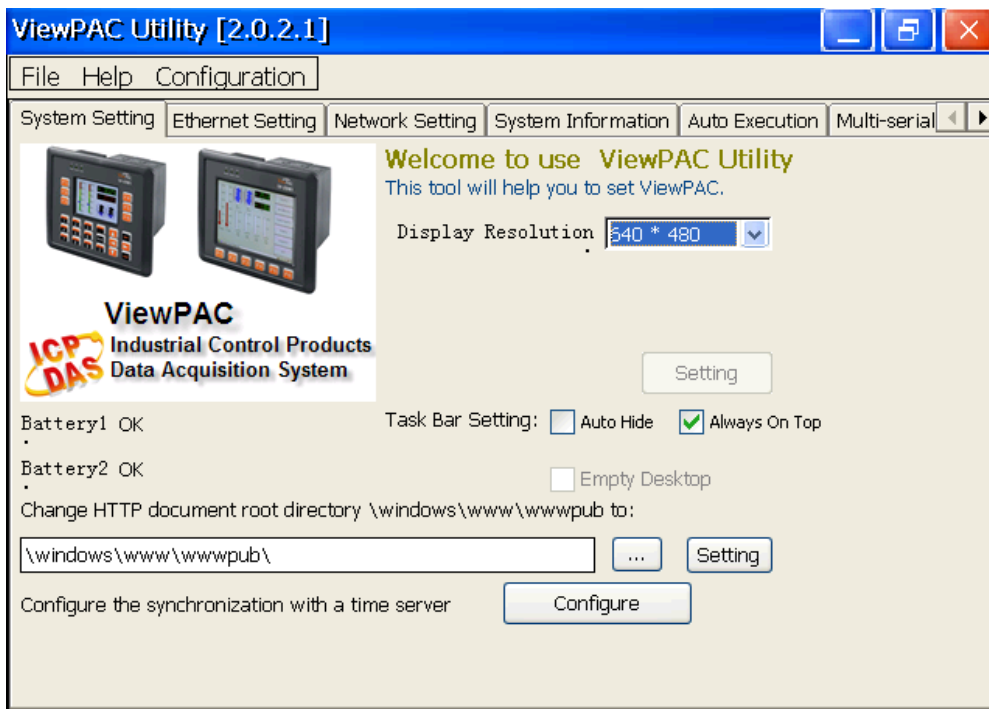

3.5.1. Menu Bar

The ViewPAC Utility includes the following function menu. All function menus will be explained later.

✓ File Menu

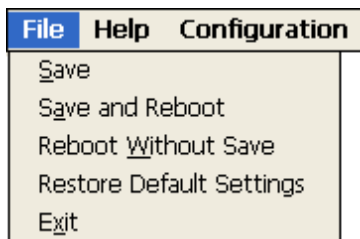

✓ Help Menu

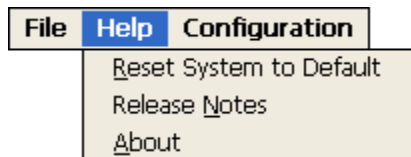

✓ Configuration Menu

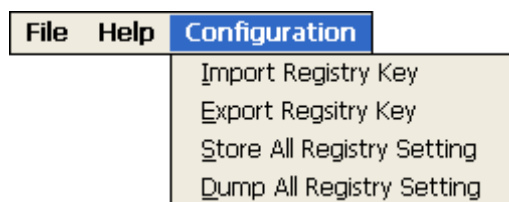

File Menu

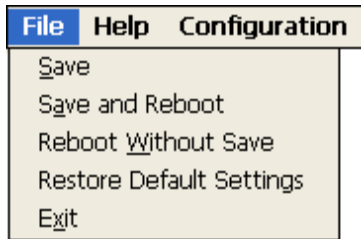

The menu commands	Use to
Save	Saves the settings into Flash. The new settings don't take effect until the ViewPAC restart.
Save and Reboot	Saves the settings into Flash and restart the ViewPAC. The new settings will take effect after the ViewPAC restart.
Reboot Without Save	Restarts the ViewPAC without save the settings into Flash.
Restore Default Settings	Restarts the settings of ViewPAC to its factory default values. The settings include configuration setting, network setting, auto execution, etc.
Exit	Exits the ViewPAC Utility.

Help Menu

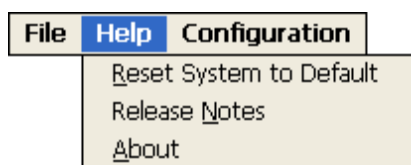

The menu commands	Use to
Reset System to Default	Resets the system interrupt status to default. The operation used in the situation when the interrupt crash. You can select this operation to reset the interrupt status without rebooting the device.
Release Notes	Checks out what's new and the know issues.
About	Displays a dialog box with information about ViewPAC Utility, including the current version and copyright information.

Configuration Menu



The menu commands	Use to
Import Registry Key	<p>Backs up a sub-key of registry by using a registration entry (.reg) file.</p> <p>How to use:</p> <p>Step 1: Select the “Import Registry Key”, then the “Open” dialog box will appear</p> <p>Step 2: On the “Open” dialog box, select a specific .reg file to import</p> <p>Warning:</p> <ol style="list-style-type: none"> 1. The .reg file which should be saved by “Export Registry Key”. 2. It will not save automatically after import a .reg file.
Export Registry Key	<p>Makes a back up of a registry sub-key</p> <p>How to use:</p> <p>Step 1: Select the “Export Registry Key”, then the “Export Registry” box will appear</p> <p>Step 2: Select a specific root key</p> <p>Step 3: Input a specific path of sub-key</p> <p>Step 4: Push the “OK” button, then the “Save As” dialog box will appear prompting you to select a location where you want to save this exported file</p> <p>Warning:</p> <p>The export operation will export all the sub-keys of the specific key which you input.</p>
Store All Registry Setting	<p>Stores all registry setting to flash from .das file which is saved by “Dump All Registry Setting”.</p> <p>How to use:</p>

The menu commands	Use to
	<p>Step 1: Select the “Store All Registry Setting” , then the “Open” dialog box will appear</p> <p>Step 2: On the “Open” dialog box, select a specific .das file to store</p> <p>Warning:</p> <ol style="list-style-type: none"> 1. The .das file which should be saved by “Dump All Registry Setting”. 2. It will save automatically after store .das file.
Dump All Registry Settings	<p>Dump all registries setting to .das file.</p> <p>How to use:</p> <p>Select the “Dump All Registry Setting”, then the “Save As” dialog box will appear prompting you to select a location where you want to save this exported file.</p>

3.5.2. Property Tabs

The ViewPAC Utility includes the following property tabs, all property tabs will be explained later.

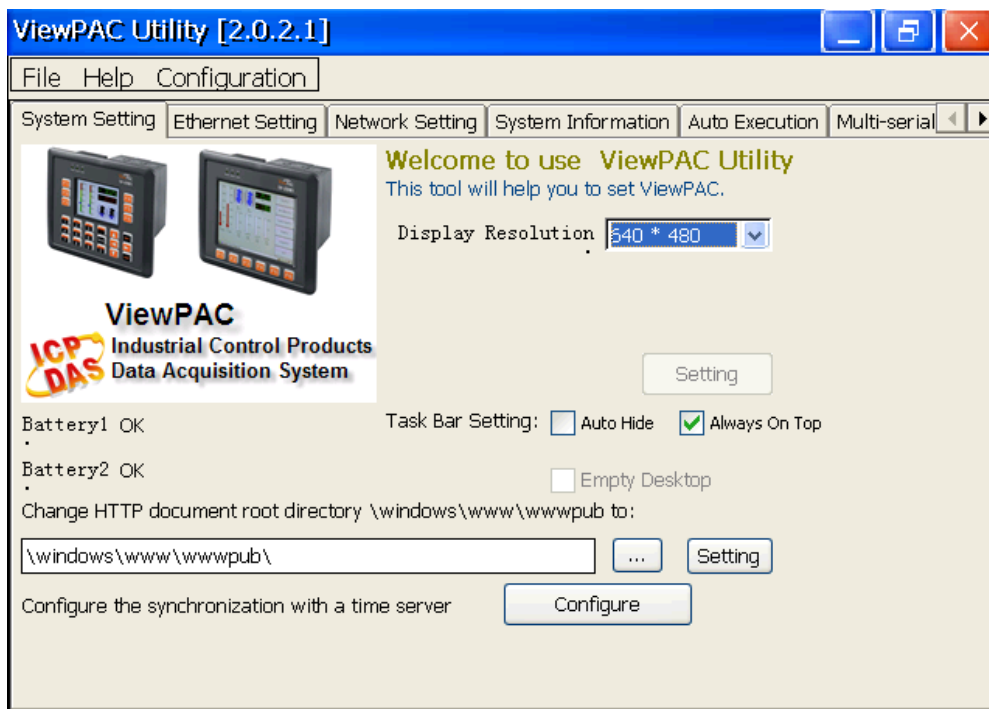

- ✓ **System Setting**
- ✓ **Ethernet Setting**
- ✓ **Network Setting**
- ✓ **System Information**
- ✓ **Auto Execution**
- ✓ **Multi-serial port wizard**
- ✓ **System Memory Setting**
- ✓ **Backplane Compatibility**

System Setting Tab

The System tab provides functions to configure the task bar HTTP directory path.

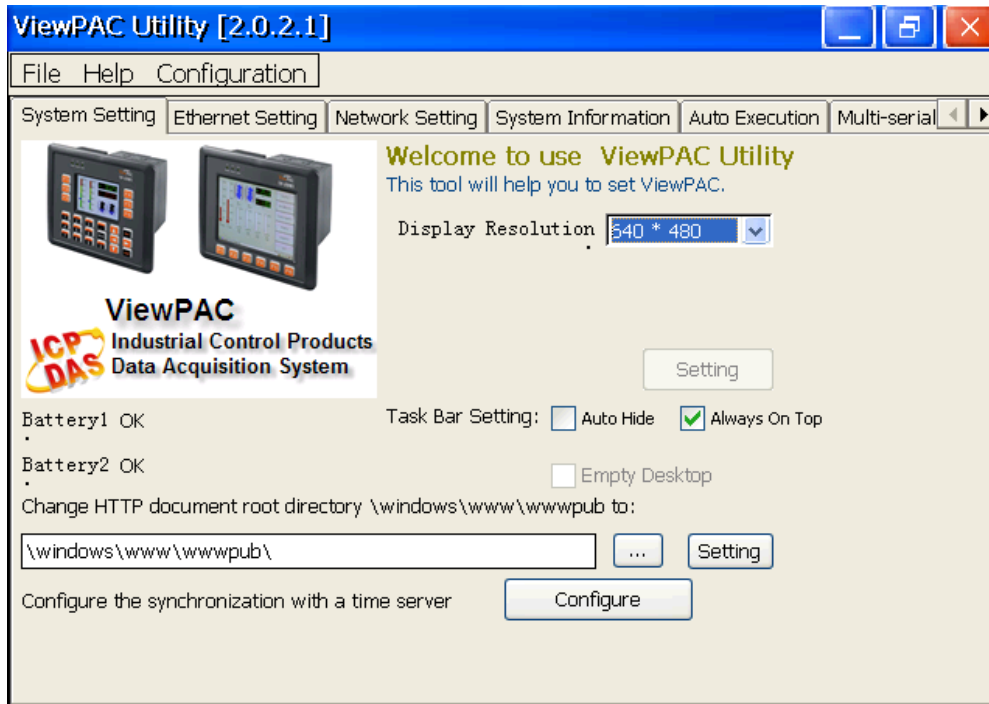

The tab use to	How to use
Adjust the size of the desktop	Select a display resolution from the Resolution list.
Lock or Auto-Hide the taskbar	Auto-Hide: Select the Auto Hide check box Lock: Select the Always On Top check box.
Check the status of the battery	See the Battery1 and Battery2 field that displays the battery status.
Change the HTTP directory path	Enter a new path in the Change HTTP document root directory \\windows\\www\\wwwsub to field, and then press the Setting button.

Ethernet Setting Tab

The Ethernet Setting tab provides functions to configure either DHCP (Roaming) or manually configured (Static) network settings and to monitor the MAC address. Generally, DHCP is the default settings, but if you don't have a DHCP server, you must configure the network settings by using manual configuration.

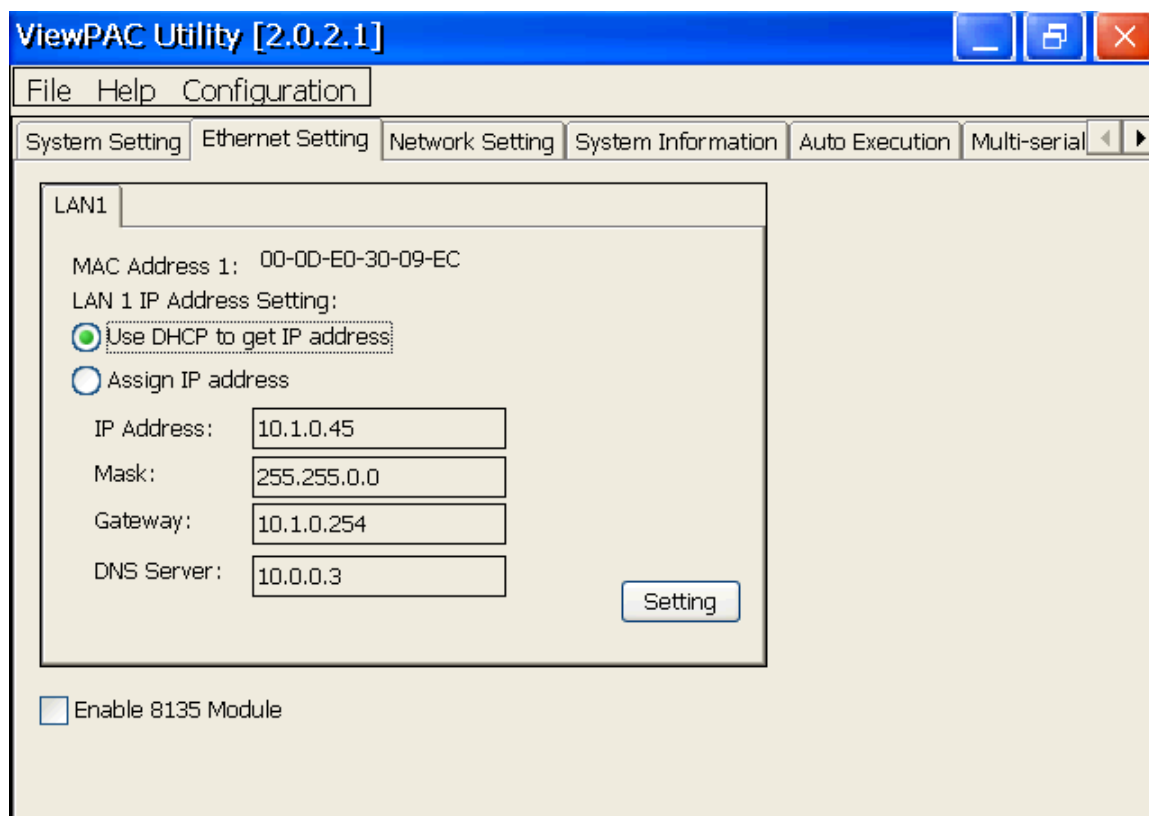

The tab use to	How to use
Configure the network settings	Obtaining an IP address automatically from DHCP: Select the Use DHCP to get IP address option, and then press the Setting button. Manually assign an IP address: Select the Assign IP address option, and then press the Setting button.
Monitor the MAC address	See the MAC Address 1 fields that display the physical address of LAN1.
Set up the i-8135 Ethernet module driver	See the next page.

8135 tab

This tab provides functions to set up the i-8135 Ethernet module driver.

The screenshot shows the ViewPAC Utility [2.0.2.1] window with the 'LAN1 8135' configuration tab selected. The interface includes a menu bar (File, Help, Configuration) and a tabbed navigation system (System Setting, Ethernet Setting, Network Setting, System Information, Auto Execution, Multi-serial). The configuration area contains the following fields and options:

- Slot: 1 (dropdown menu)
- Slot0: [Empty text box]
- Slot1: 8135 (text box)
- Slot2: [Empty text box]
- Installed driver: Slot1
- MAC Address: [Empty text box]
- Use DHCP to get IP address
- Assign IP address
- IP Address: 10.1.0.55 (text box)
- Mask: 255.255.0.0 (text box)
- Gateway: [Empty text box]
- DNS Server: 10.0.0.3 (text box)
- [Setting] button
- Enable 8135 Module

The tab use to	How to use
Set up the i-8135 network settings	Obtaining an IP address automatically from DHCP: Select the Use DHCP to get IP address option, and then press the Setting button. Manually assign an IP address: Select the Assign IP address option, and then press the Setting button.

Network Setting Tab

The Network tab consists of two tabs, Access and Login, which provides functions to enable/disable the FTP access, enable/disable anonymous FTP access, configure the FTP directory path, change HTTP document root directory and maintain the FTP accounts.

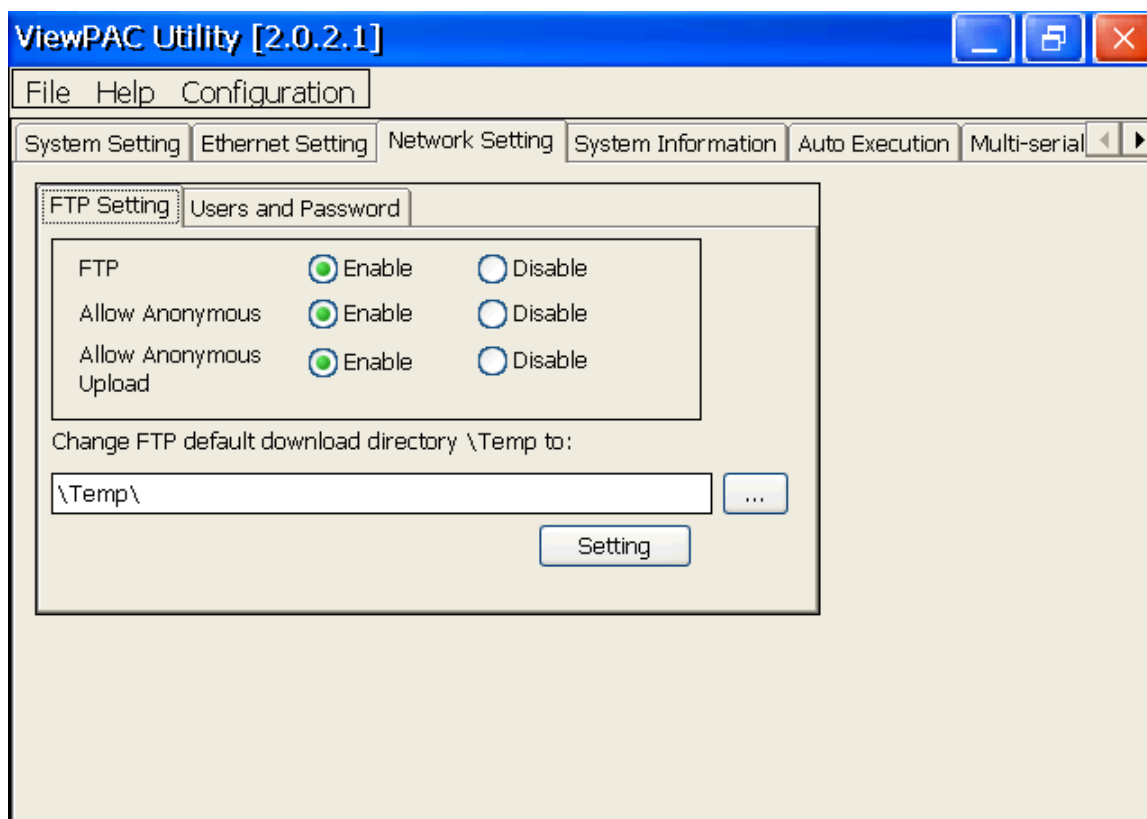

FTP Settings tab

This tab provides functions to enable/disable the FTP access, enable/disable anonymous FTP access, and configure the FTP directory path.

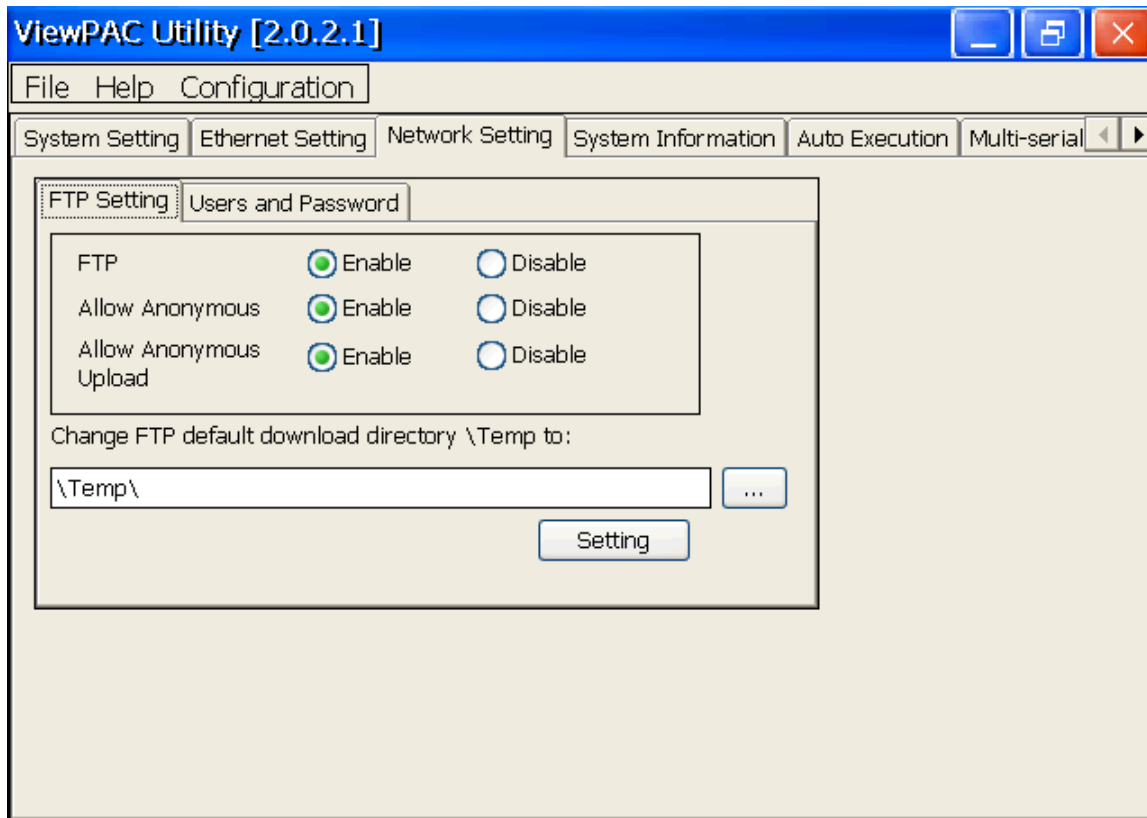

The tab use to	How to use
Enable or disable the FTP access	Enable: Select the Enable check box in the FTP field. Disable: Select the Disable check box in the FTP field.
Enable or disable anonymous FTP access	Enable: Select the Enable check box in the Allow Anonymous field. Disable: Select the Disable check box in the Allow Anonymous field.
Enable or disable anonymous FTP upload	Enable: Select the Enable check box in the Allow Anonymous Upload field. Disable: Select the Disable check box in the Allow Anonymous Upload field.
Change the FTP directory path	Enter a new path in the Change FTP default download directory field, and then press the Setting button.

Users and Password tab

This tab provides functions to maintain the FTP accounts.

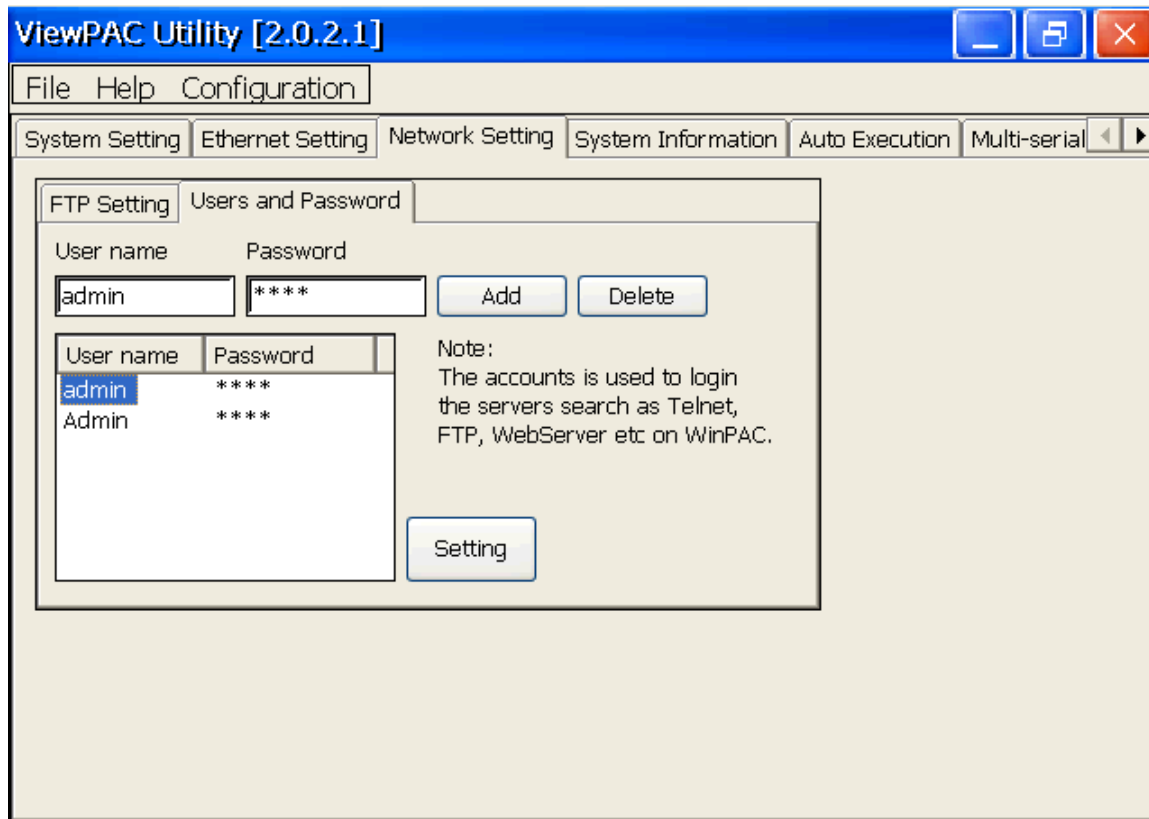

The tab use to	How to use
Maintain the FTP accounts	Refer to the Appendix C.1 How to add a user account to remote login the ViewPAC from PC.

System Information Tab

The System Information tab provides functions to monitor necessary system information of the ViewPAC-8000. The system information is the most important note of version control for upgrading system.

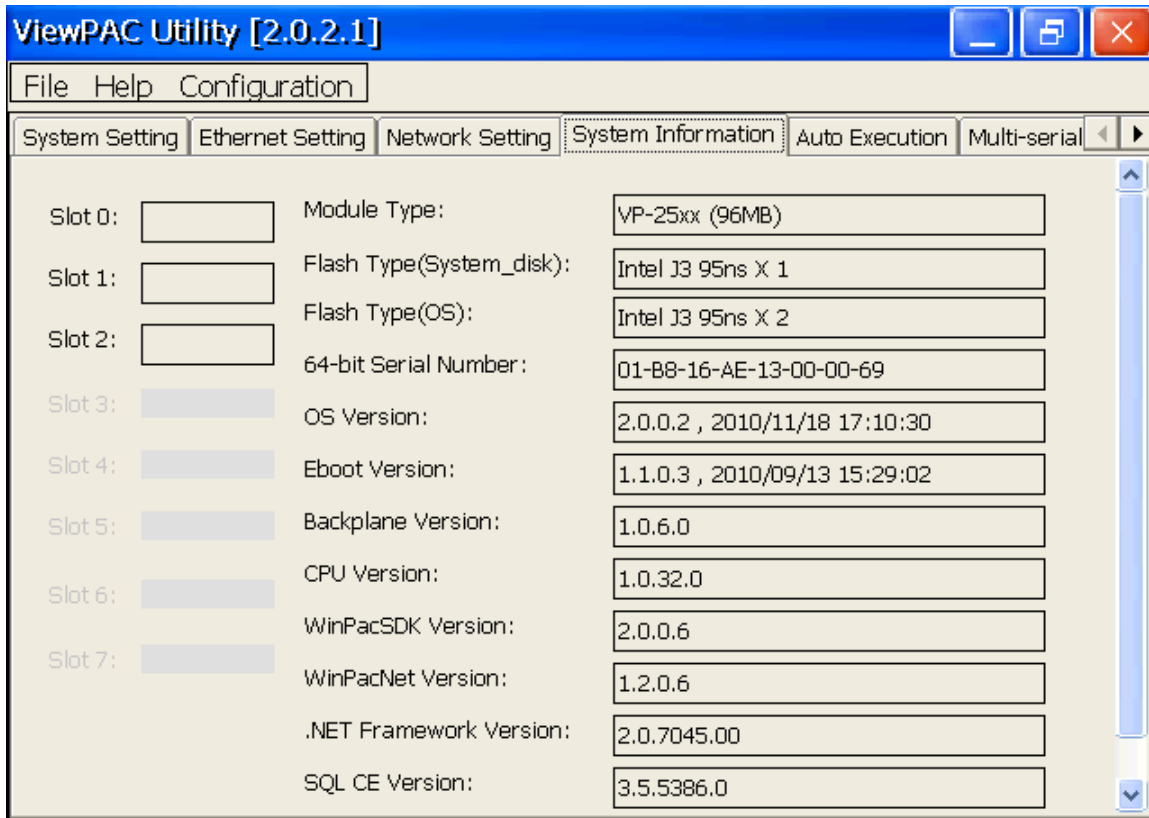

Slot	Module Type	Flash Type(System_disk)	Flash Type(OS)	64-bit Serial Number	OS Version	Eboot Version	Backplane Version	CPU Version	WinPacSDK Version	WinPacNet Version	.NET Framework Version	SQL CE Version
Slot 0:	<input type="text"/>											
Slot 1:	<input type="text"/>	Intel J3 95ns X 1										
Slot 2:	<input type="text"/>	Intel J3 95ns X 2										
Slot 3:	<input type="text"/>			01-B8-16-AE-13-00-00-69	2.0.0.2 , 2010/11/18 17:10:30							
Slot 4:	<input type="text"/>					1.1.0.3 , 2010/09/13 15:29:02						
Slot 5:	<input type="text"/>						1.0.6.0					
Slot 6:	<input type="text"/>							1.0.32.0				
Slot 7:	<input type="text"/>								2.0.0.6			
										1.2.0.6		
											2.0.7045.00	
												3.5.5386.0

Auto Execution Tab

The Auto Execute tab provides functions to configure programs running at ViewPAC-8000 startup, it allows users to configure ten execute files at most.



The allowed file types are .exe and .bat, and they are executed in order of program 1, program 2, etc.

ViewPAC Utility [2.0.2.1]

File Help Configuration

Auto Execution Multi-serial port wizard Key property System Memory Setting

Program 1: \System_Disk\SnmpUtility.exe Browse

Program 2: Browse

Program 3: Browse

Program 4: Browse

Program 5: Browse

Program 6: Browse

Program 7: Browse

Program 8: Browse

Program 9: Browse

Program 10: Browse

Setting

At most 10 programs can be specified to execute automatically at system startup.

The tab use to

Configure programs running at startup

How to use

Press the **Browse** button to select the execute file which you want, and then press the **Setting** button.

Multi-Serial Port Wizard Tab



The Multi-serial port provides functions for installation of the RS-232/RS-422/RS-485 communication module driver.



The table below shows the expansion RS-232/RS-422/RS-485 communication modules that are compatible with the ViewPAC.

Item	RS-232	RS-422/RS-485	Isolation	Connector
I-8112iW	2	-	2500 Vrms	DB-9 x 2
I-8114W	4	-	-	DB-37 x 1
I-8114iW	4	-	2500 Vrms	DB-37 x 1
I-8142iW	-	2	2500 Vrms	Terminator block x 1
I-8144iW	-	4	2500 Vrms	Terminator block x 1

The ViewPAC can be expanded to support up to 16 I/O modules.

For more detailed information about these support modules, please refer to http://www.icpdas.com/products/Remote_IO/i-8ke/selection_rs232_i8k.htm

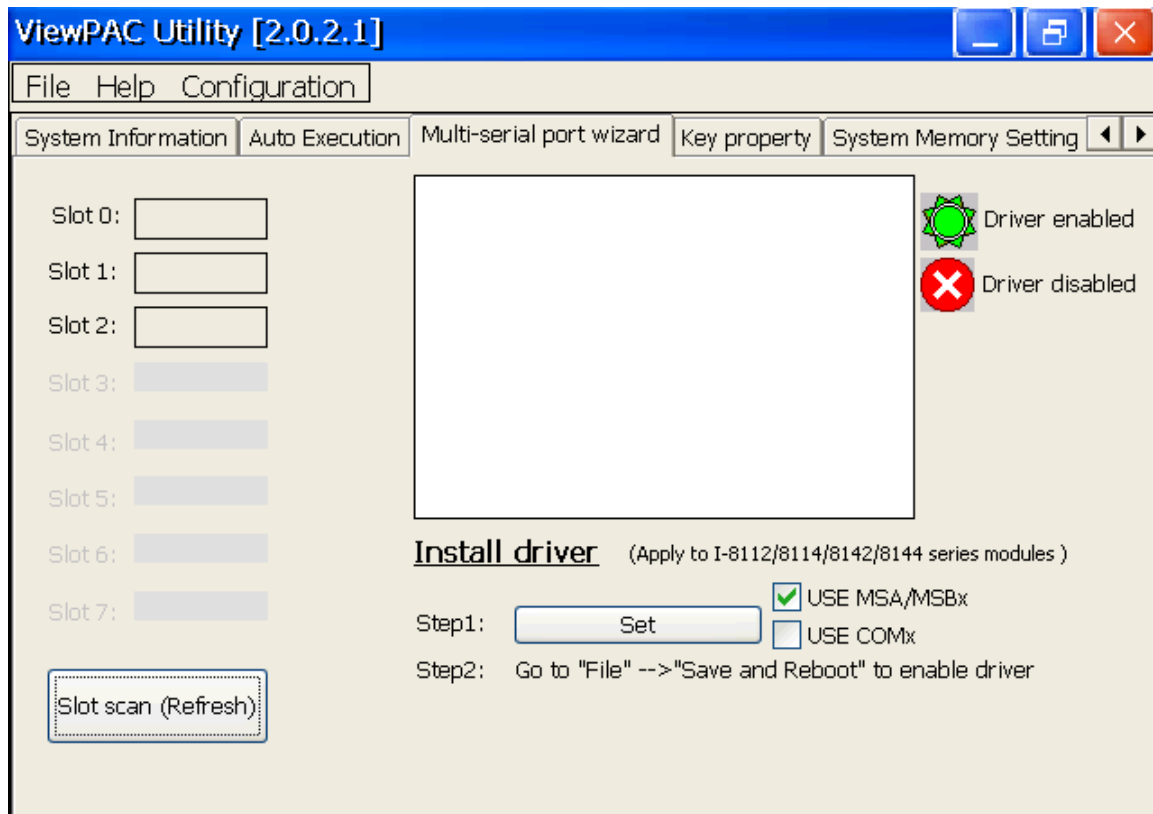

Key Property Tab

The Key Property tab provides functions to specify the programmable key to launch any program that you wish.



The allowed file types are .exe and .bat.

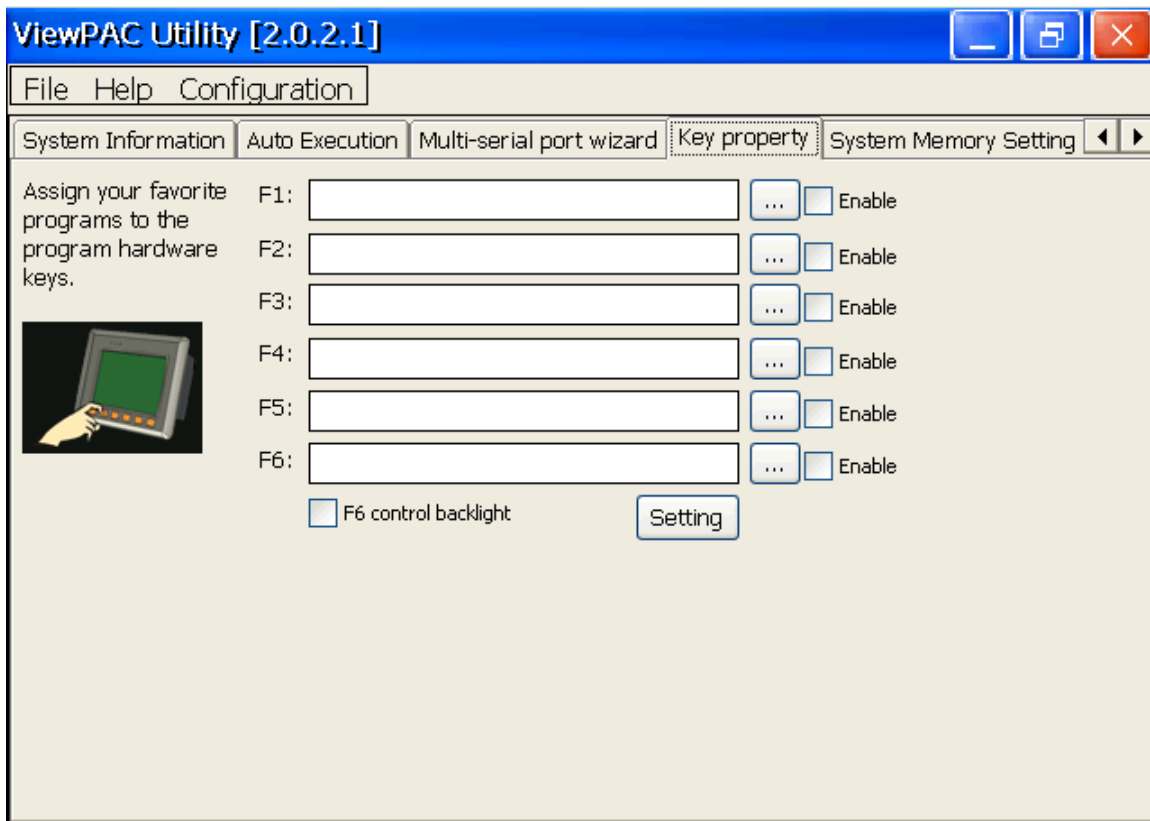

The tab use to	How to use
Specify the programmable key to launch the program	Press the ... button to select the execute file which you want, select the Enable check box, and then press the Setting button.
Specify the programmable key to control backlight	Select the F6 control backlight check box, and then press the Setting button.

System Memory Tab

The SRAM Setting tab provides functions to adjust and monitor the unused RAM.

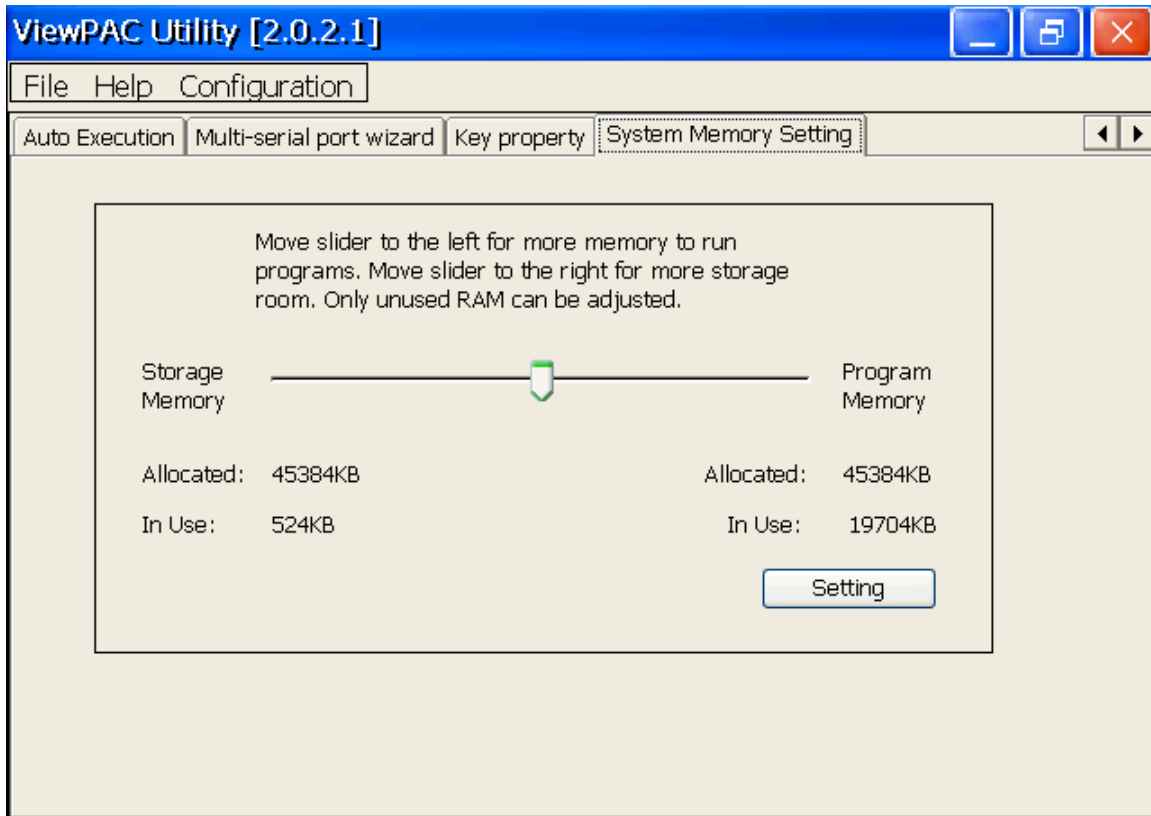

The tab use to	How to use
Adjust display	Move the slider left to release more memory running programs or move the slider right to release more storage room, and then press the Setting button

4. Your First ViewPAC Program

This chapter describes the components of the ViewPAC SDK, and provides step by step tutorial for developer that will teach you how to create your first ViewPAC program.

Before writing your first program, ensure that you have the necessary development tools and the corresponding ViewPAC SDKs are installed on your system.

4.1. Preparing the Development Tools

There are several programming tools available for application developers targeting Windows CE-based ViewPAC. One of the following tools must be installed on the Host PC.

- ✓ Microsoft eMbedded Visual C++
- ✓ Visual Basic.net
- ✓ Visual C#

4.2. Installing ViewPAC SDKs

The ViewPAC SDK is a Software Development Kit (SDK) that contains C header files, C libraries and documents.

Below is a step by step procedure for installing the ViewPAC SDKs.

Step 1: Insert the CD into your CD-ROM drive

Step 2: Execute the “PAC270_SDK_YYYYMMDD.msi” which is located in
CD:\Napdos\wp-8x4x_ce50\SDK\

Step 3: Follow the prompts until the installation is complete

4.3. Understanding the ViewPAC APIs

The ViewPAC SDKs includes several application programming interfaces (APIs) that allows you perform various supporting tasks when developing ViewPAC.

➤ Requirements

The ViewPAC SDK only supports NET Framework 2.0 or above.

➤ Installation Path

After installing the ViewPAC SDKs, a number of functions can be installed on the Host PC, and this installation puts the header files, libraries into the following public places so they are easily changed by update the ViewPAC SDKs.

Header files:

C:\Program Files\Windows CE Tools\wce500\PAC270\lcpdas\Include\ARMV4\

Libraries:

C:\Program Files\Windows CE Tools\wce500\PAC270\lcpdas\Lib\ARMV4\

4.3.1. ViewPAC SDK Overview

4.3.1.1. WinPAC Standard API

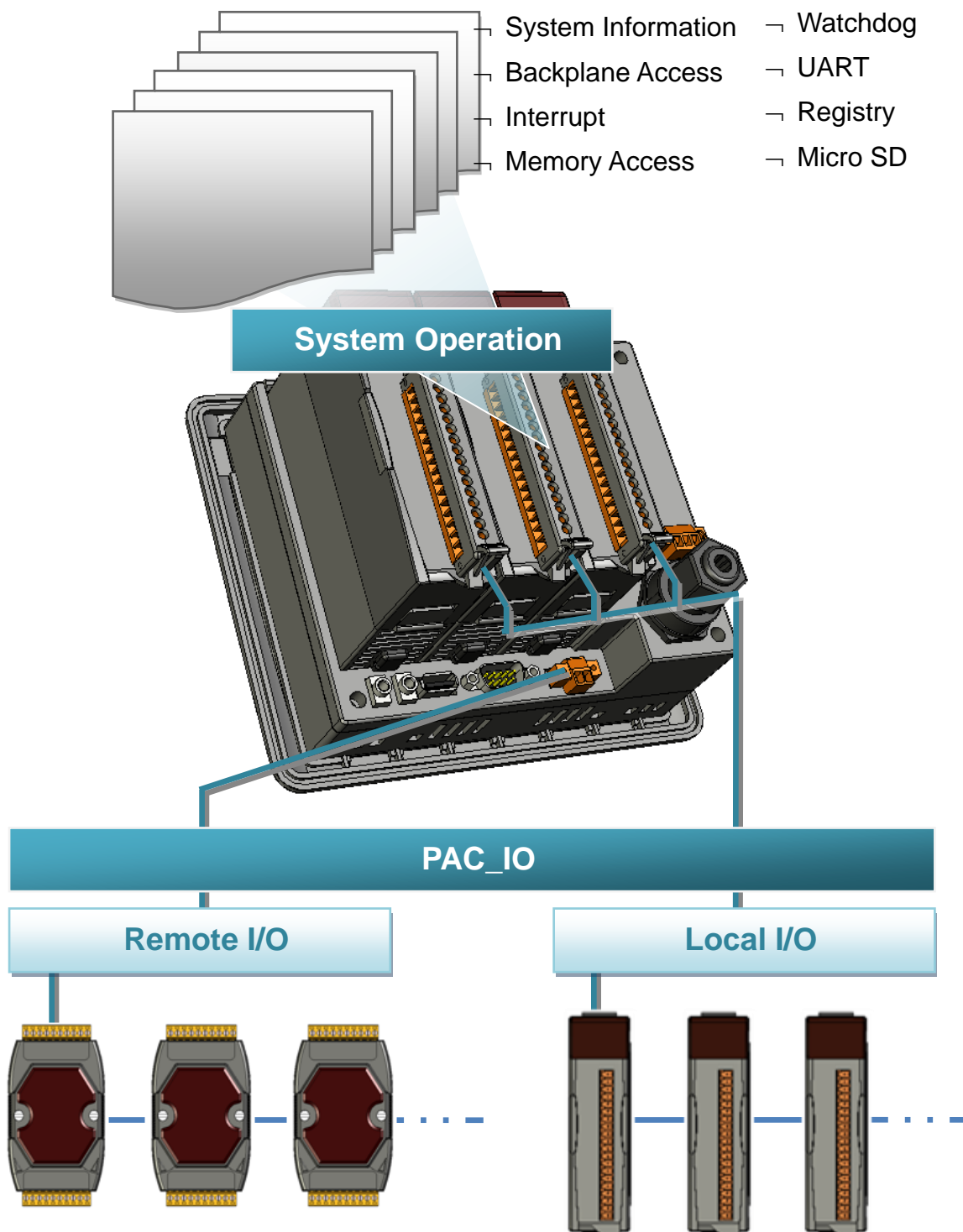

- **SystemInformation Functions**

Provides reference information for the system status.

- **Backplane Access API**

Provides reference information for the backplane access APIs, including Hot Plug and backplane information.

- **Interrupt API**

Provides reference information for the Interrupt APIs

- **Memory Access API**

Provides reference information for the memory R/W APIs, including EEPROM and SRAM.

- **Watchdog Functions**

Provides reference information for the watchdog APIs, including hardware watchdog and OS watchdog.

- **UART API**

Provides reference information for the UART APIs.

- **Registry API**

Provides reference information for the registry.

- **microSD Management API**

Provides reference information for the microSD Manager.

- **PAC_IO API**

Provides reference information for IO APIs, including local and remote. In additions, no matter 8K or 87K modules use the same API.

- **Error Handling API**

Provides reference information for error handling.

4.3.1.2. ViewPAC Particular API

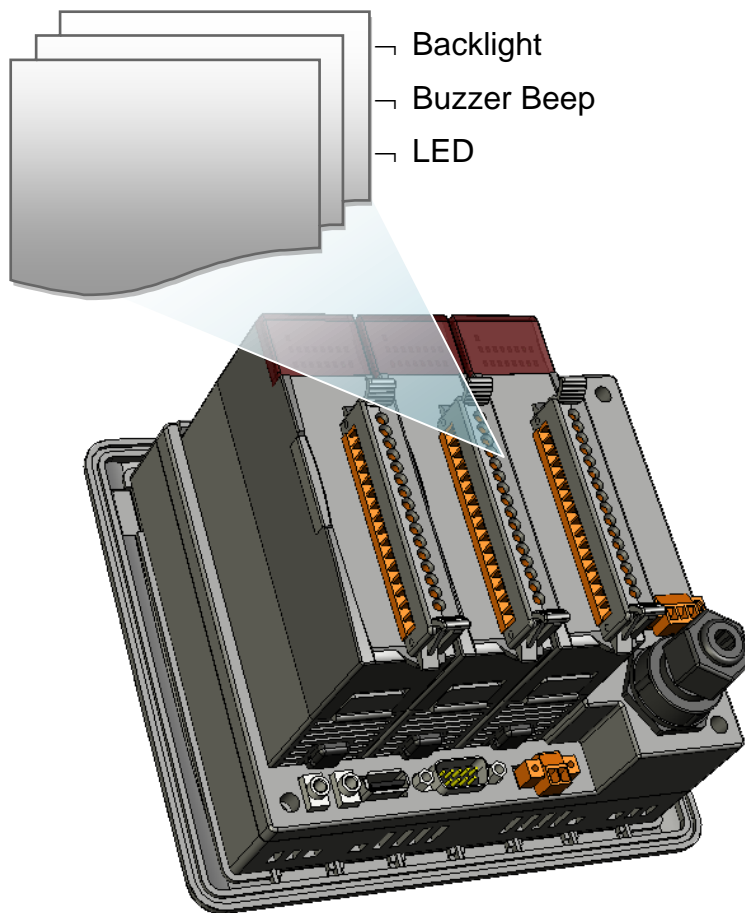

- **Backlight Functions**

Provides reference information for the backlight.

- **Buzzer Beep Functions**

Provides reference information for the buzzer.

- **LED Functions**

Provides reference information for the LED

4.3.2. ViewPAC SDK Reference

For full usage information regarding the description, prototype and the arguments of the functions, please refer to the “WinPAC Standard API Manual” and “ViewPAC Particular API Manual” located at:

CD:\Napdos\vp-2000_ce50\Document\SDK_Document\

ftp://ftp.icpdas.com/pub/cd/winpac/napdos/vp-2000_ce50/document/sdk_document/

✓ WinPAC Standard API Manual

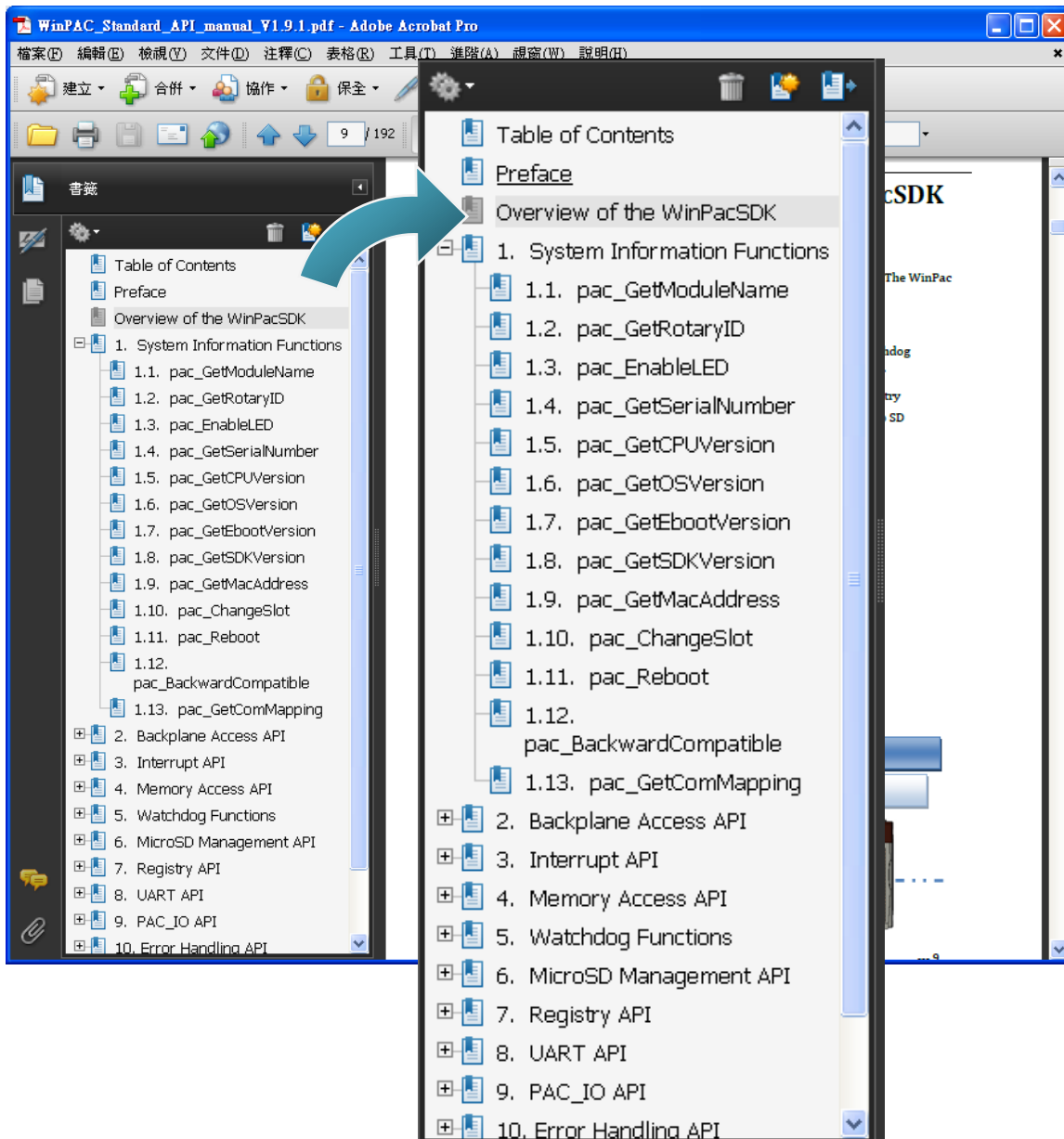

✓ ViewPAC Particular API Manual

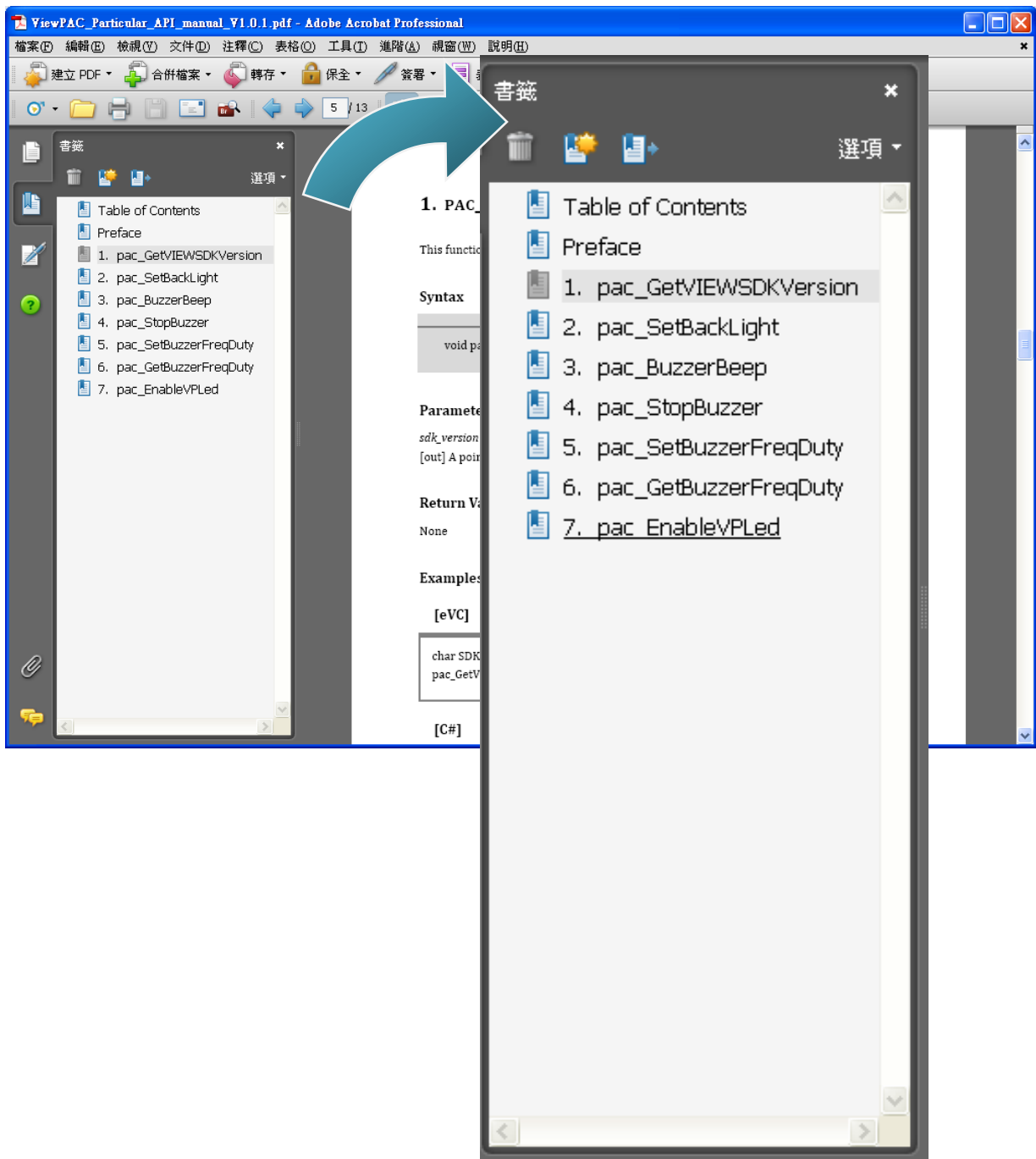

4.4. Your First Program in C#

To create a demo program with C# development tool includes the following main steps:

1. Create a new project
2. Add project reference for an application
3. Design and Build an application program
4. Execute the application on the ViewPAC

All main steps will be described in the following subsection.

4.4.1. Create a new project

Step 1: Start the Visual Studio 2005

Step 2: On the “File” menu, select the “New” command, and then click the “Project” command

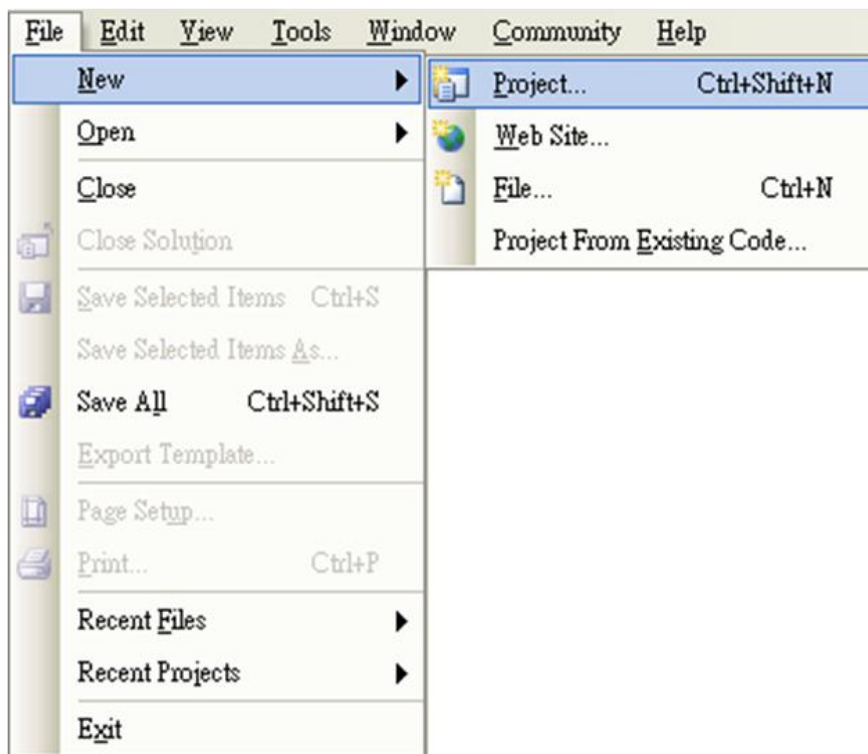

Step 3: In the “New Project” dialog box do the following in this order



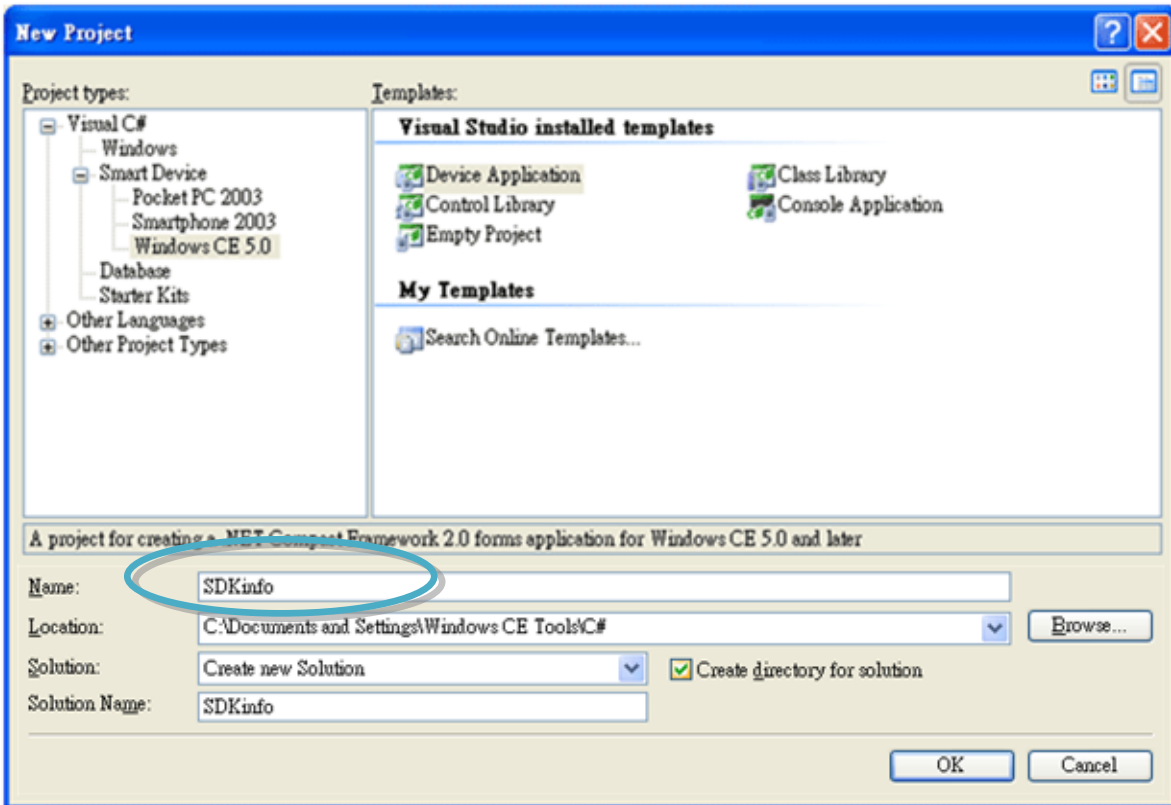

Step 4: Click OK to start creating a “SDKInfo” project

4.4.2. Add project reference for an application

Step 1: On the “Solution Explorer” window, right-click the “References” and then click the “Add Reference...” command

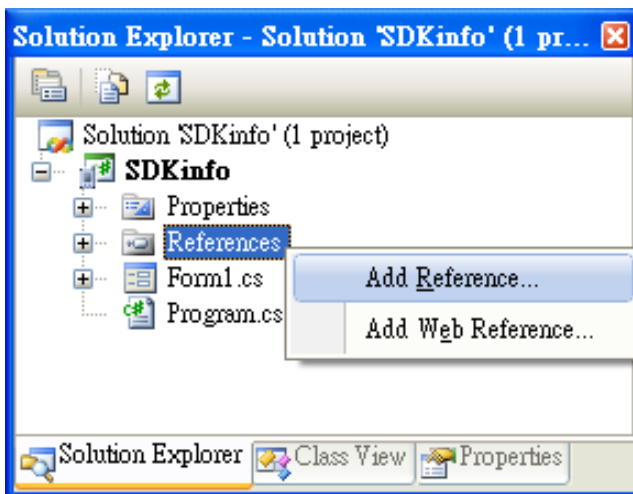

Step 2: In the “Add Reference” dialog box, select the “Browse” tab, and then specify the directory of the “ViewPacNet.dll” file in the “File name” field

The “ViewPACnet.dll” file can be obtained from:

CD:\Napdos\vp-2000_ce50\SDK\ViewPACNet\

http://ftp.icpdas.com/pub/cd/winpac/napdos/vp-2000_ce50/sdk/ViewPACnet/

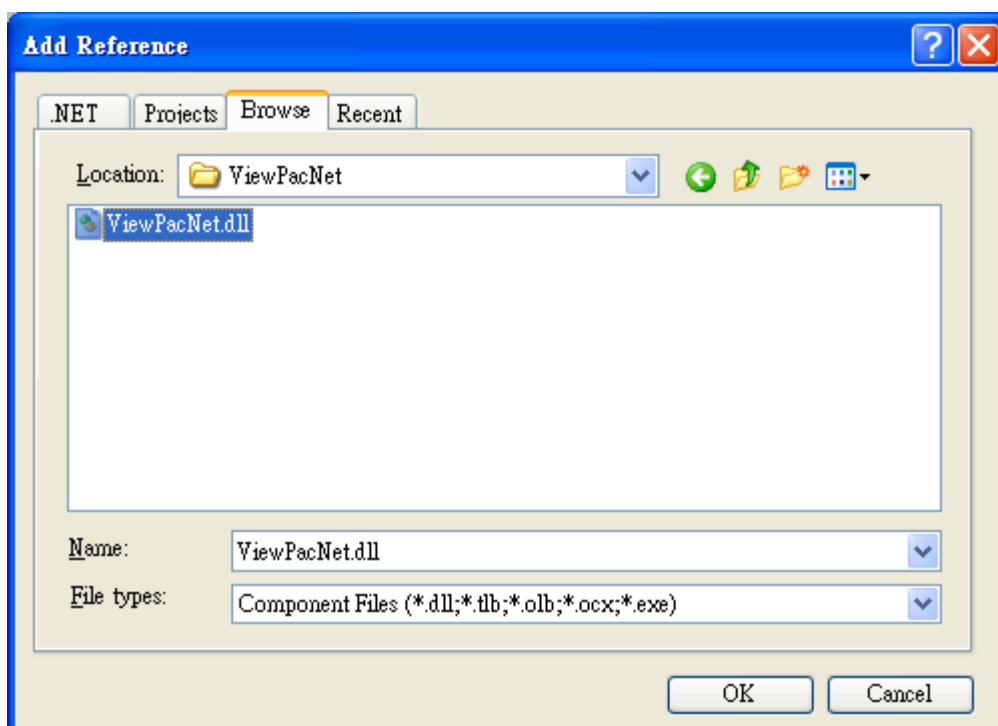

4.4.3. Design and Build an application program

Step 1: Add a  Button “button” object in the “Form1” dialog box

Step 2: Right-click the “button” object and click the “Properties” command

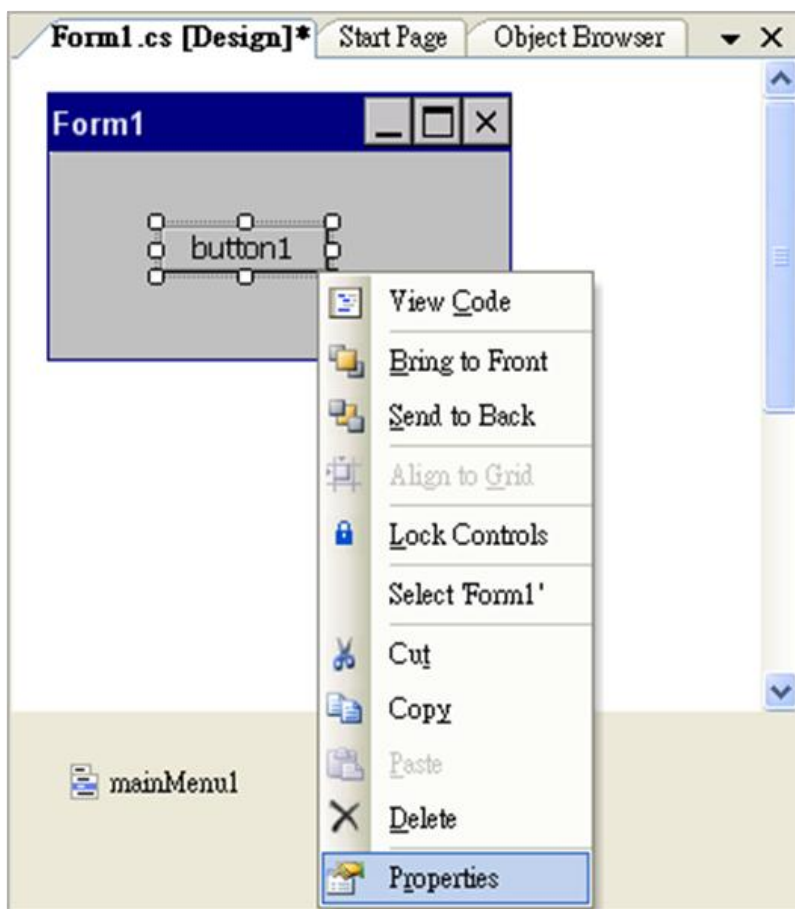

Step 3: On the “Properties” window, type “Check the SDK version” in the “Text” edit box

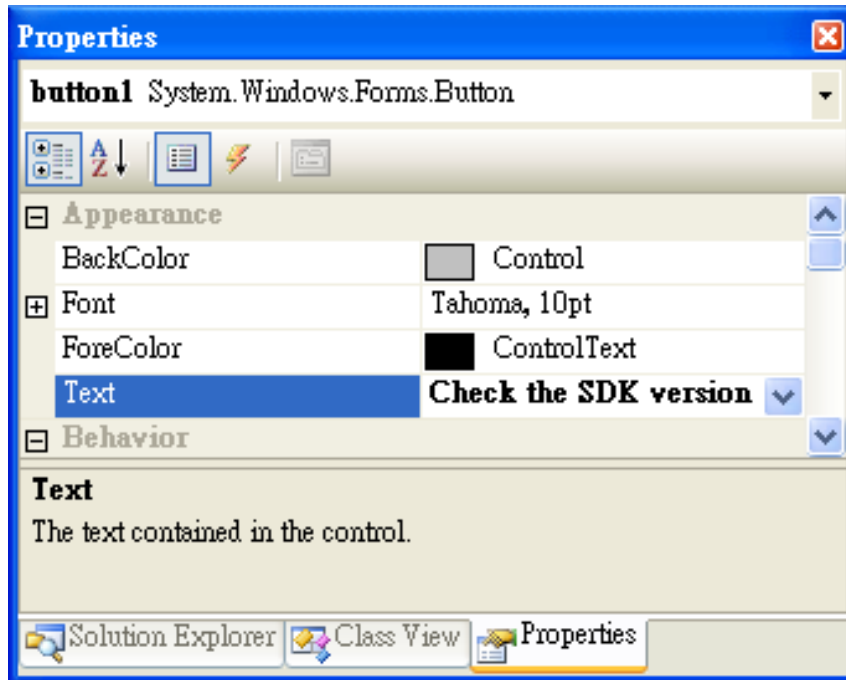

Step 4: Right-click the “Form1” dialog box and click the “View Code” command to open the editor window

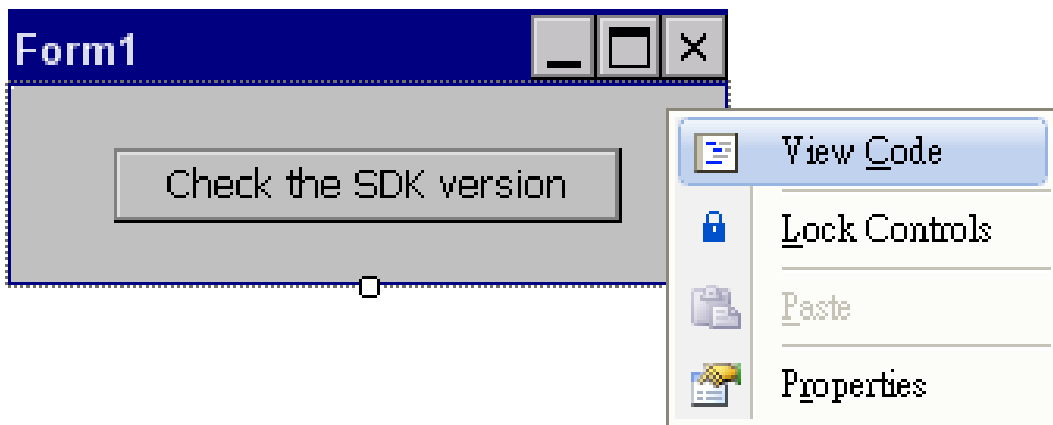

Step 5: Insert the “using ViewPACNet;” into the header area after “using System.Windows.Forms;”

```
using System;
using System.Linq;
using System.Collections.Generic;
using System.ComponentModel;
using System.Data;
using System.Drawing;
using System.Text;
using System.Windows.Forms;
using ViewPACNet;

namespace SDKInfo
{
    public partial class Form1 : Form
    {
        public Form1()
        {
            InitializeComponent();
        }
    }
}
```

Step 6: In the “Form1” dialog box, double-click the “button” object to open the editor window



Step 7: Insert the following code in the Editor Window

```
MessageBox.Show(pac_GetVIEWSDKVersion());
```

```
namespace SDKinfo
{
    public partial class Form1 : Form
    {
        public Form1()
        {
            InitializeComponent();
        }

        private void button1_Click(object sender, EventArgs e)
        {
            MessageBox.Show(ViewPAC.pac_GetVIEWSDKVersion());
        }
    }
}
```



4.4.4. Execute the application on the ViewPAC

Step 1: On the “Build” menu, click the “Build Solution” command

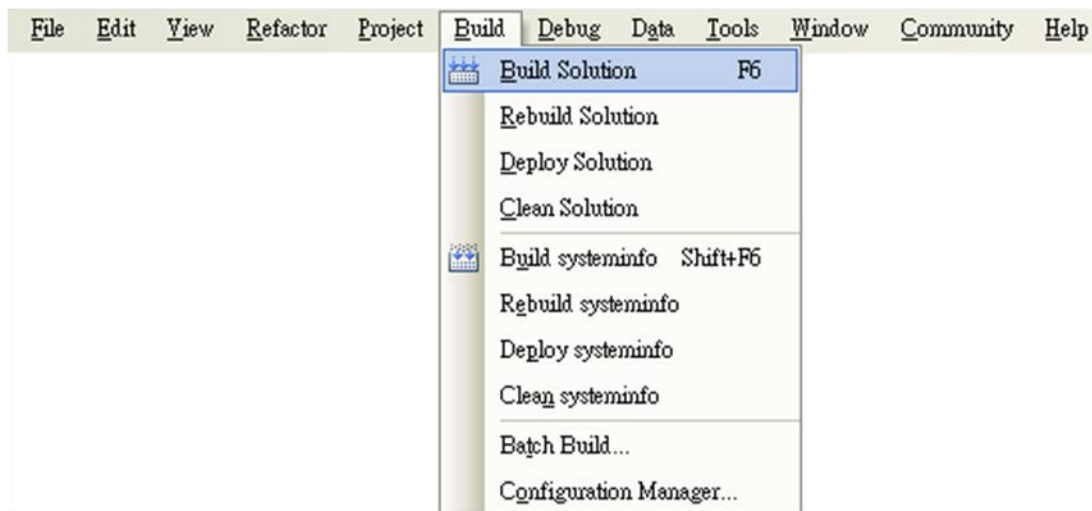

Step 2: Open the web browser and type the IP address to connect the FTP server of ViewPAC

Step 3: Upload the “SDKinfo.exe” application and the corresponding “ViewPacNet.dll” file to the ViewPAC via the ViewPAC FTP server

Tips & Warnings



For applications programming in C# and VB.net with .net framework, when executing these application on the ViewPAC controller, the corresponding “ViewPACnet.dll” file must be in the same directory as the .exe file

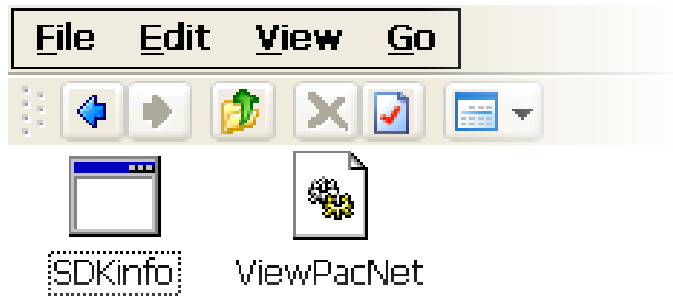

Step 4: On the ViewPAC, execute the uploaded file



4.5. Your First Program in VB.net

To create a demo program with C# development tool includes the following main steps:

1. Create a new project
2. Add project reference for an application
3. Design and Build an application program
4. Execute the application on the ViewPAC

All main steps will be described in the following subsection.

4.5.1. Create a new project

Step 1: Start the Visual Studio 2005

Step 2: On the “File” menu, select the “New” command, and then click the “Project” command

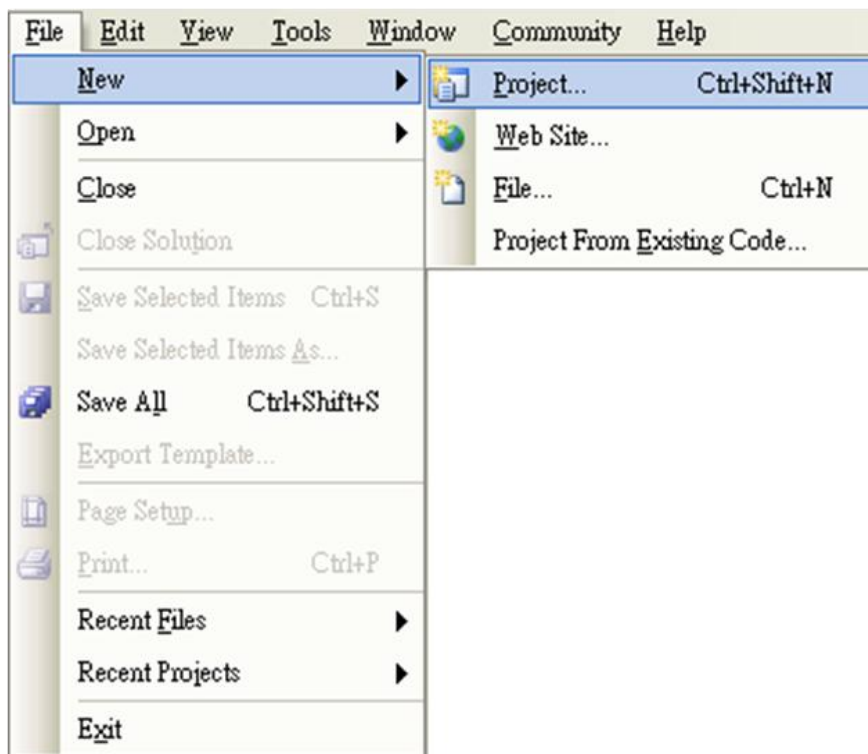

Step 3: In the “New Project” dialog box do the following in this order



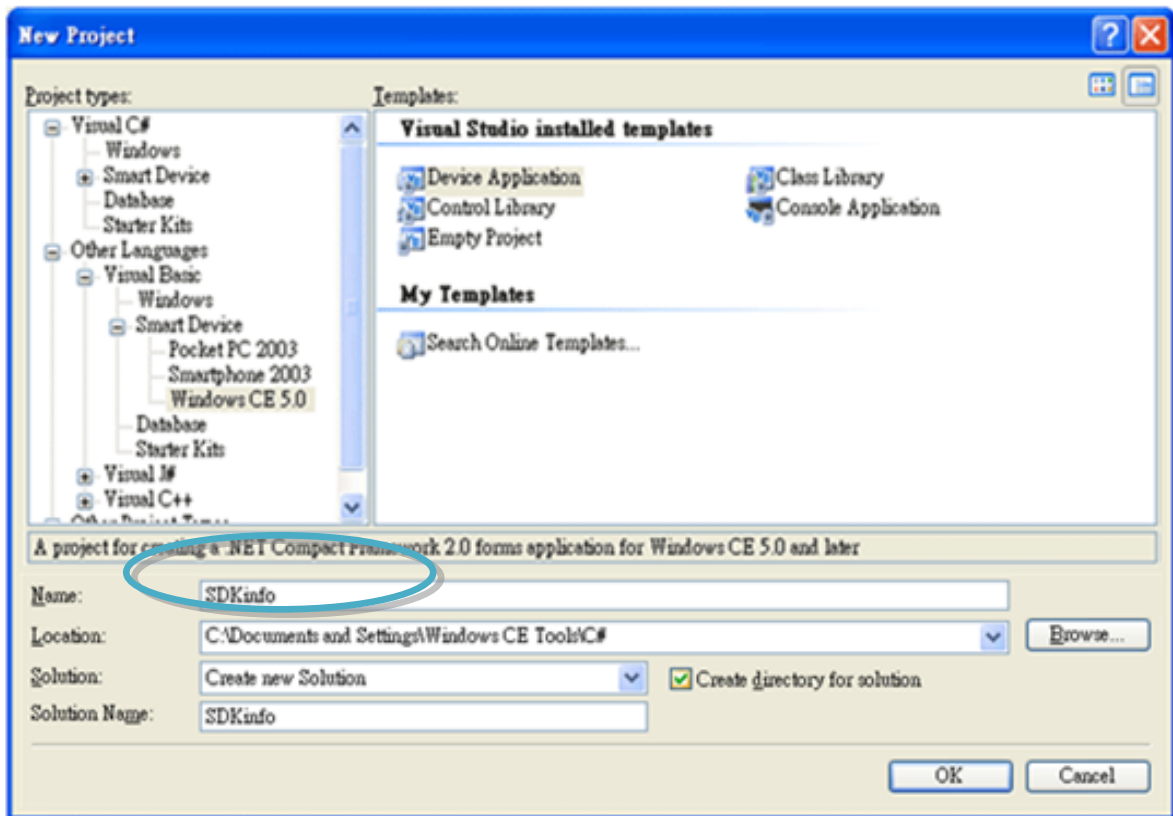

Step 4: Click OK to start creating a “SDKInfo” project

4.5.2. Add project reference for an application

Step 1: On the “Class View” window, right-click the “Reference” and then click the “Add Reference...” command

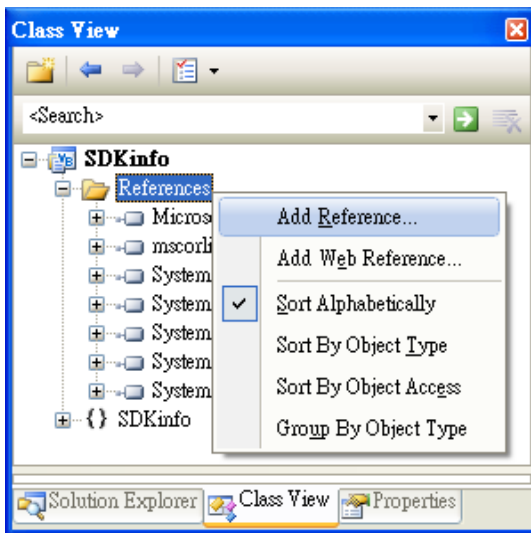

Step 2: In the “Add Reference” dialog box, select the “Browse” tab, and then specify the directory of the “ViewPACNet.dll” file in the “File name” field

The “Winpacnet.dll” file can be obtained from:

CD:\Napdos\vp-2000_ce50\SDK\ViewPACNet\

http://ftp.icpdas.com/pub/cd/winpac/napdos/vp-2000_ce50/sdk/ViewPACnet/

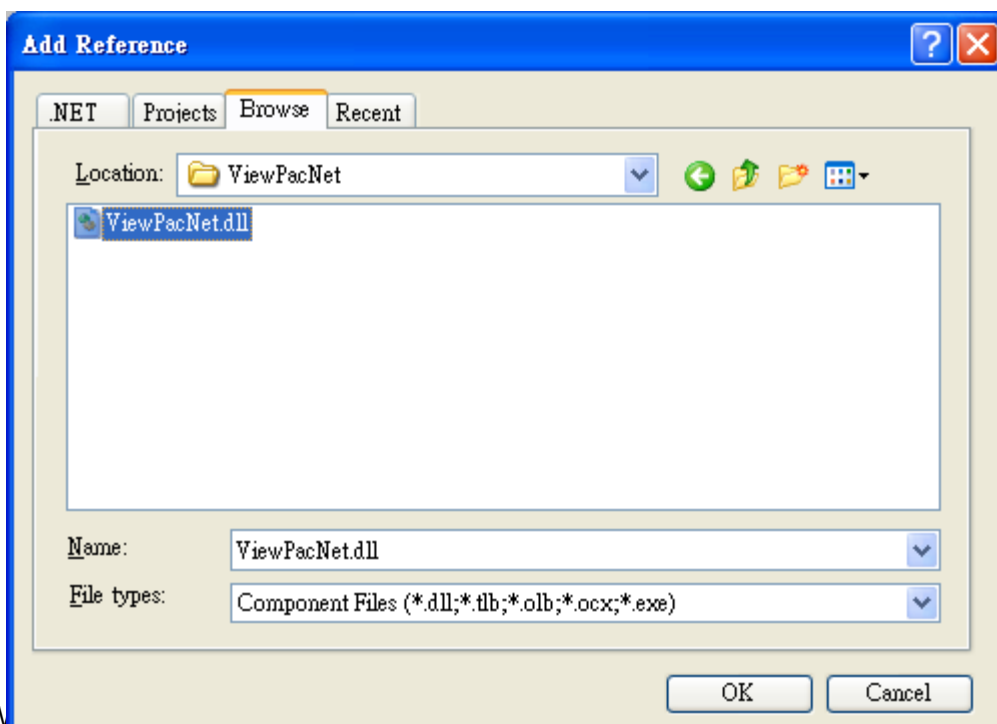

4.5.3. Design and Build an application program

Step 1: Add a  Button “button” object in the “Form1” dialog box

Step 2: Right-click the “button” object and click the “Properties” command

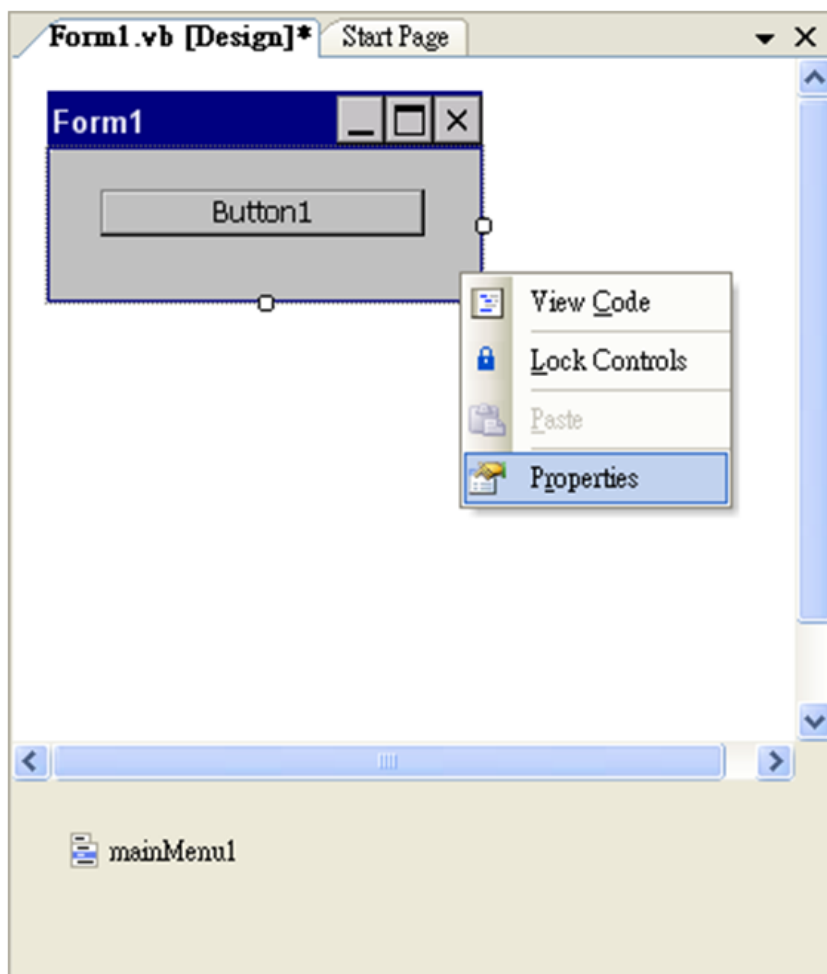

Step 3: On the “Properties” window, type “Check the SDK version” in the “Text” edit box

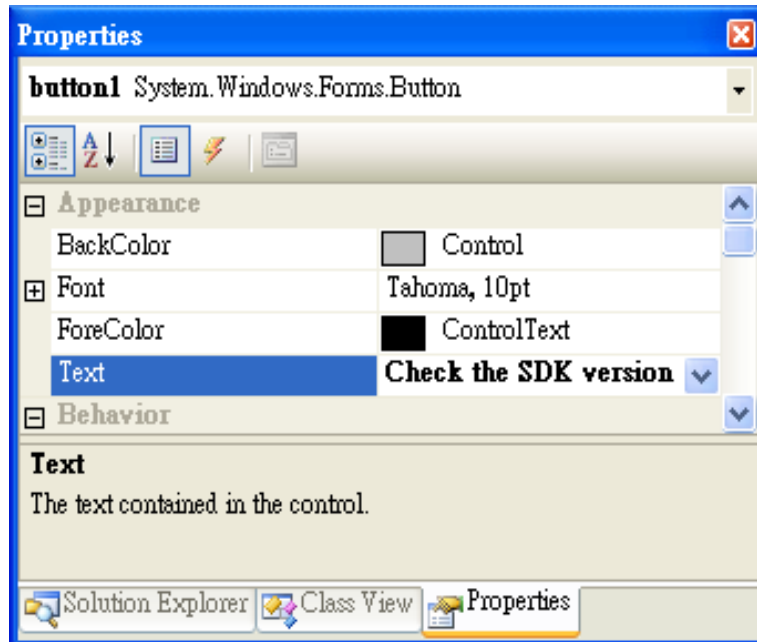

Step 4: In the “Form1” dialog box, double-click the “button” object to open the editor window



Step 5: Insert the following code in the Editor Window

1. Imports ViewPacNet
2. MessageBox(ViewPACNet.pac_GetOSVersion())

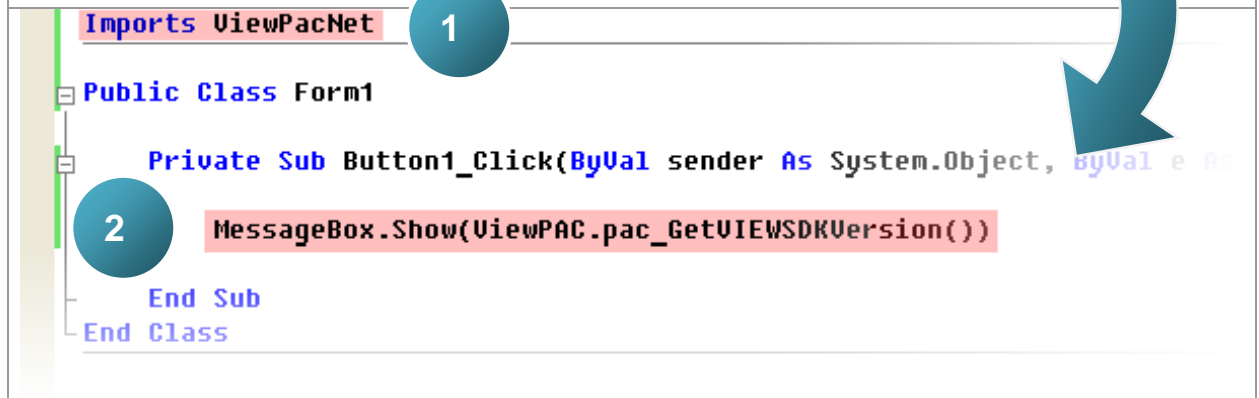

```
Imports ViewPacNet

Public Class Form1

    Private Sub Button1_Click(ByVal sender As System.Object, ByVal e As EventArgs) Handles Button1.Click
        MessageBox.Show(ViewPAC.pac_GetVIEWSDKVersion())
    End Sub
End Class
```

4.5.4. Execute the application on the ViewPAC

Step 1: On the “Build” menu, click the “Build Solution” command

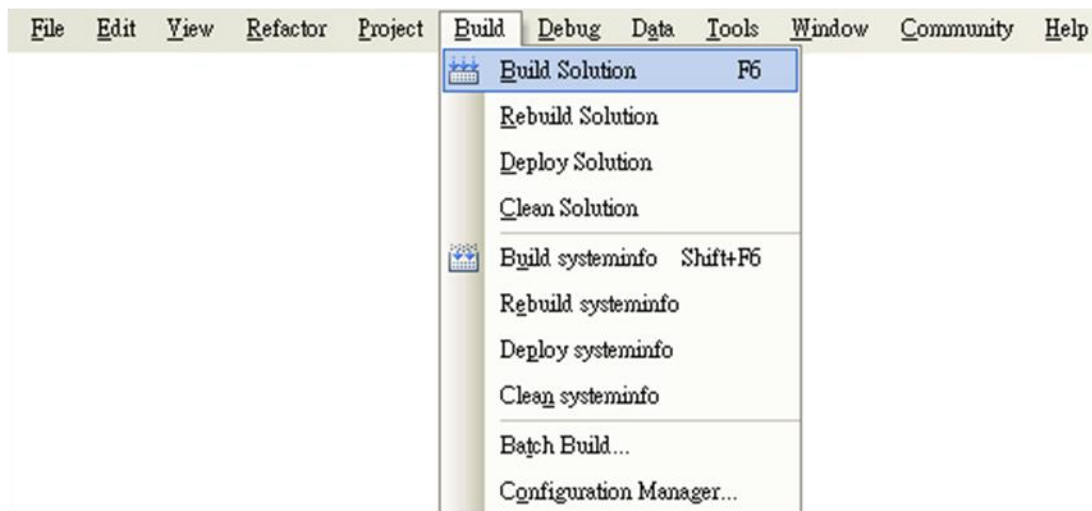

Step 2: Open the web browser and type the IP address to connect the FTP server of ViewPAC

Step 3: Upload the “SDKinfo.exe” application and the corresponding “ViewPacNet.dll” file to the ViewPAC via the ViewPAC FTP server

Tips & Warnings



For applications programming in C# and VB.net with .net framework, when executing these application on the ViewPAC controller, the corresponding “ViewPACnet.dll” file must be in the same directory as the .exe file

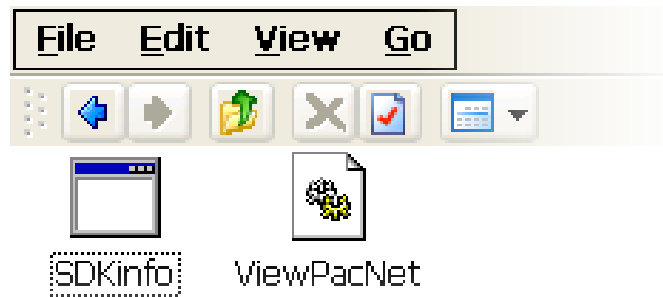

Step 4: On the ViewPAC, execute the uploaded file



4.6. Your First Program in eMbedded Visual C++

To create a demo program with eMbedded Visual C++ development tool includes the following main steps:

1. Create a new Forms-Based project
2. Configure compiler options
3. Design and Build an application program
4. Execute the application on the ViewPAC

All main steps will be described in the following subsection.

4.6.1. Create a new Forms-Based project

Step 1: Start the Microsoft Embedded Visual C++

Step 2: From the “File” menu, click the “New” command

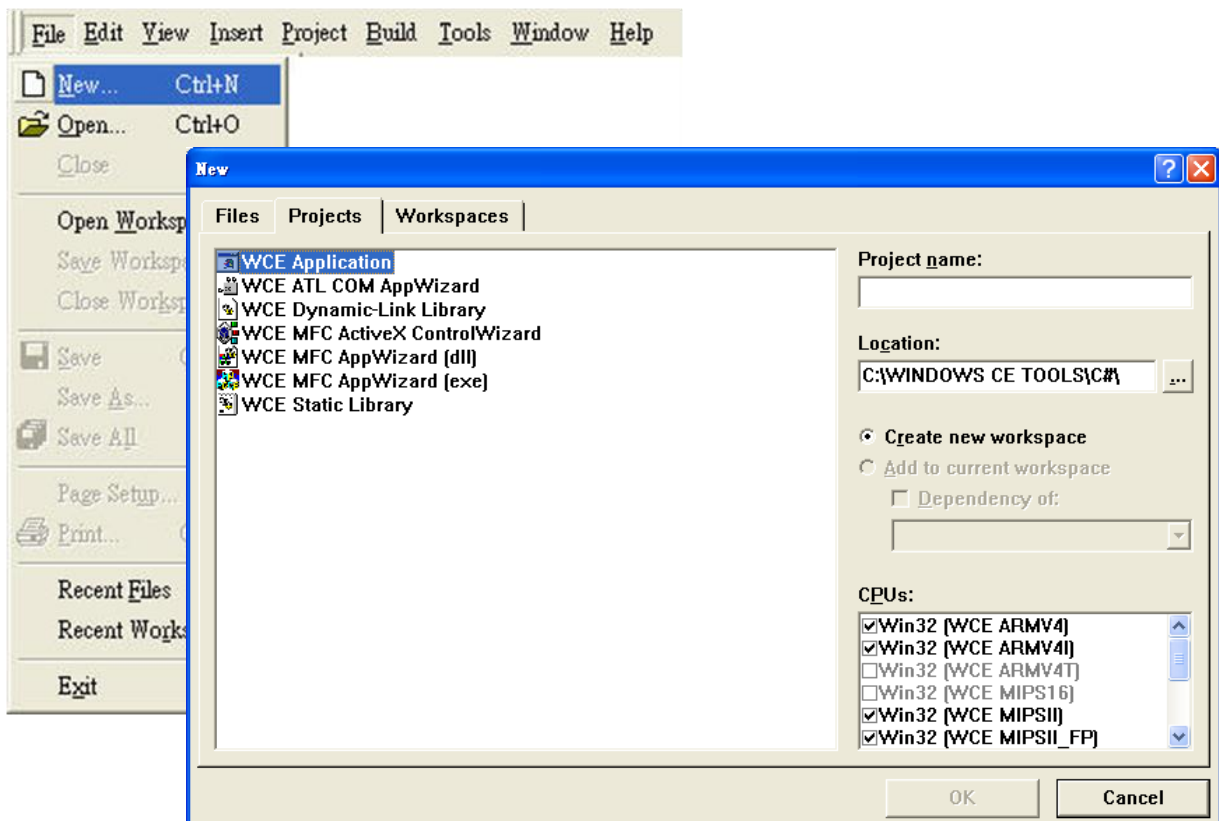

Step 3: In the “New” dialog, select the “Projects” tab and do the following in this order

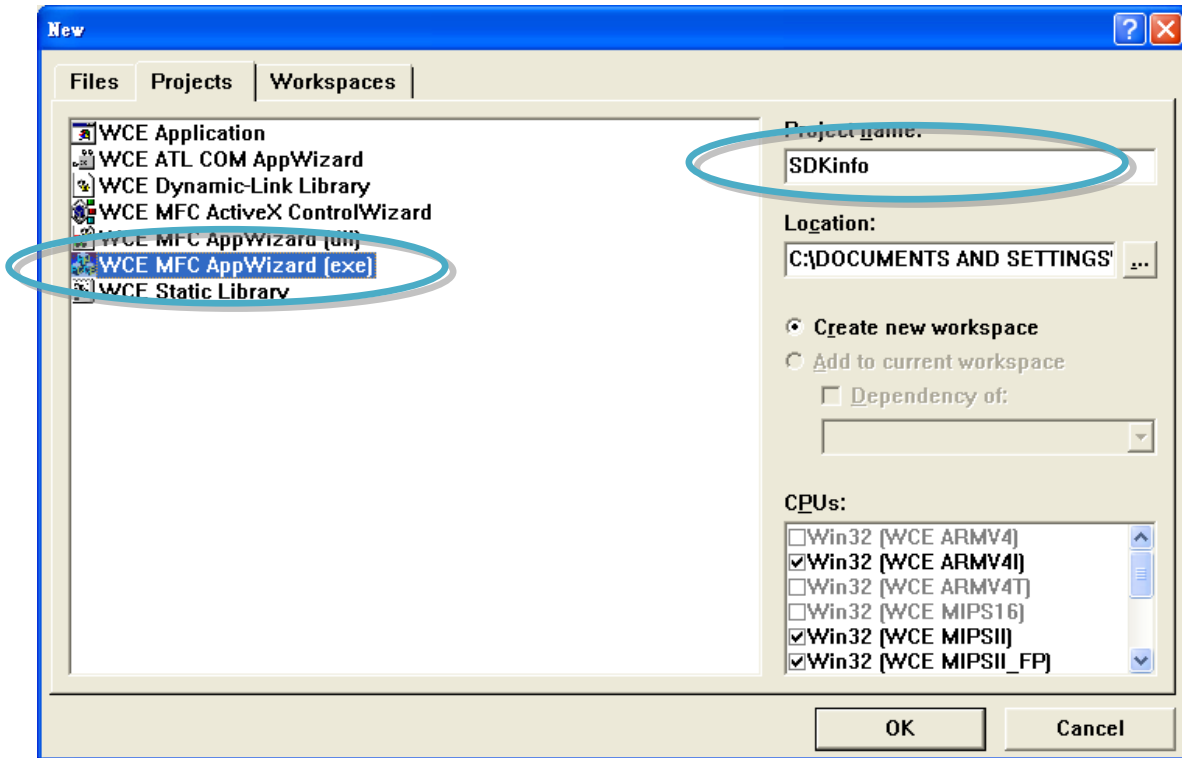

Tips & Warnings



The selected CPU type must have “Win32 [WCE ARMV4I]”

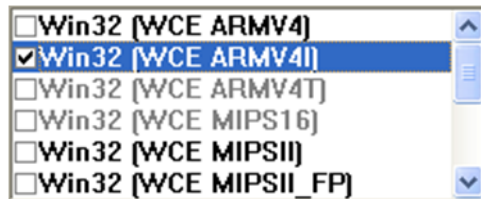

Step 4: Click the “OK” button to start the wizard

Step 5: On the first page of the wizard, select “Dialog based” option and then click the “Next” button to the next step

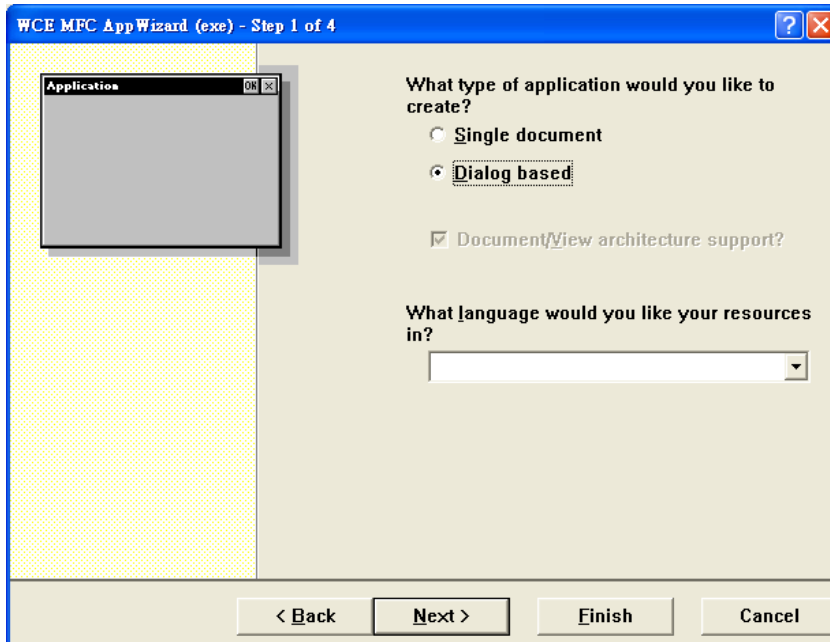

Step 6: On the next page of the wizard, leave all the options as they are, and then click the “Next” button to the next step

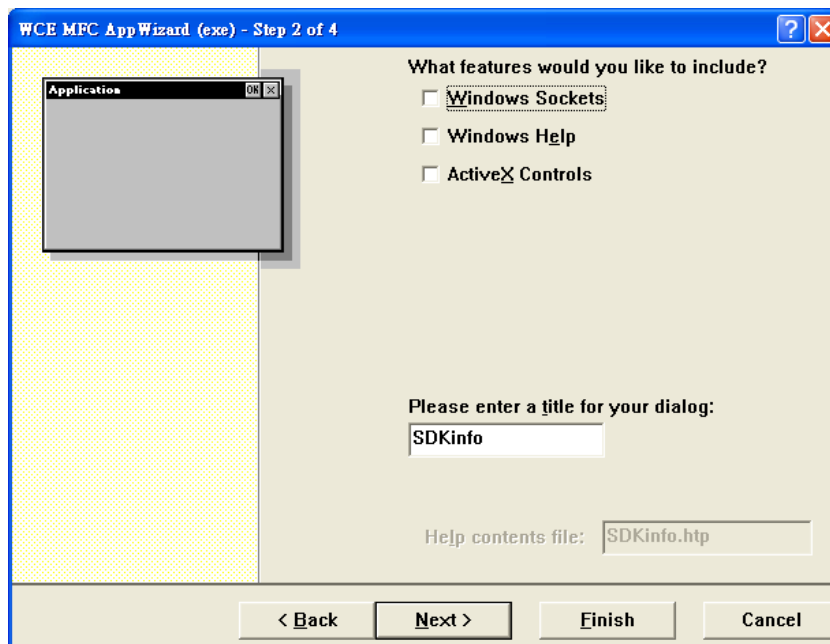

Step 7: On the next page of the wizard, leave all the options as they are, and then click the “Next” button to the next step

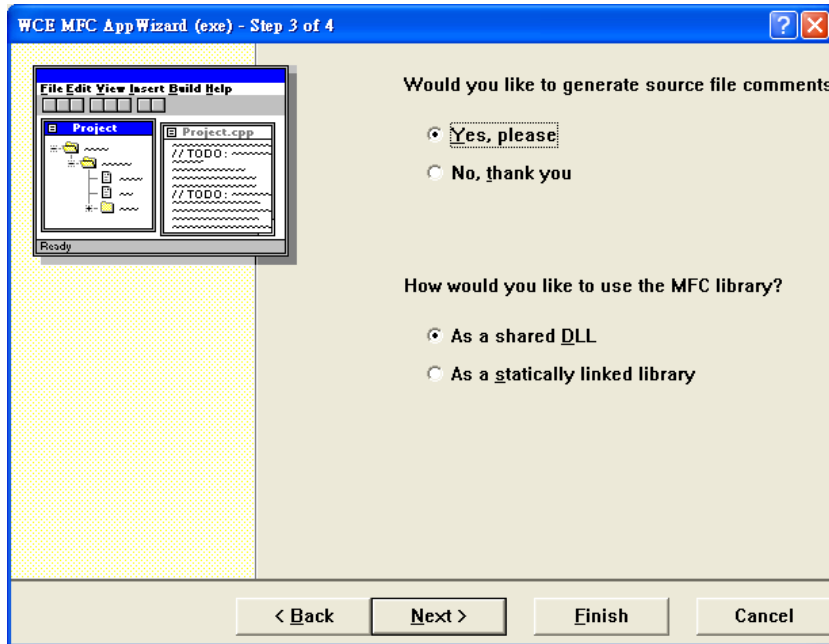

Step 8: On the next page of the wizard, leave all the options as they are, and then click the “Finish” button to complete the wizard

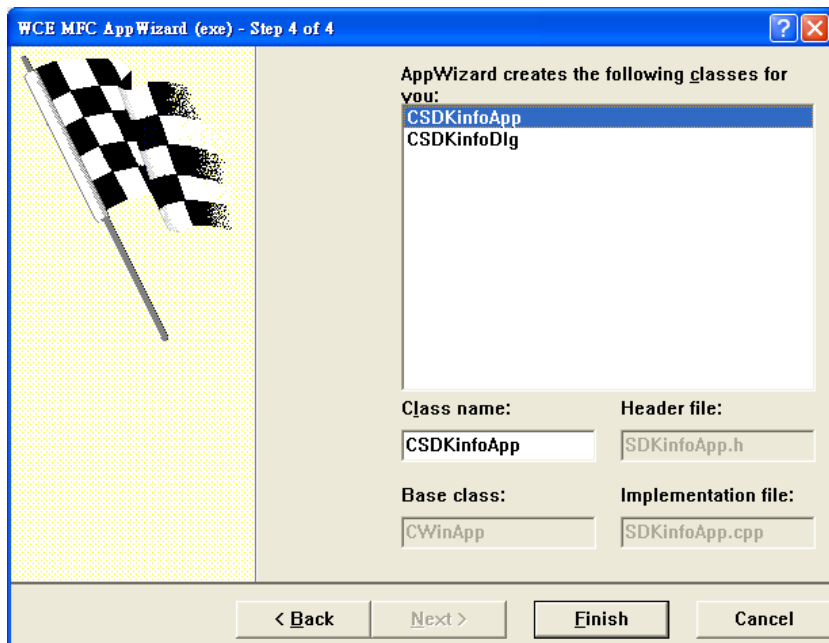

Step 9: The final summary appears, click the “OK” button to exit the wizard

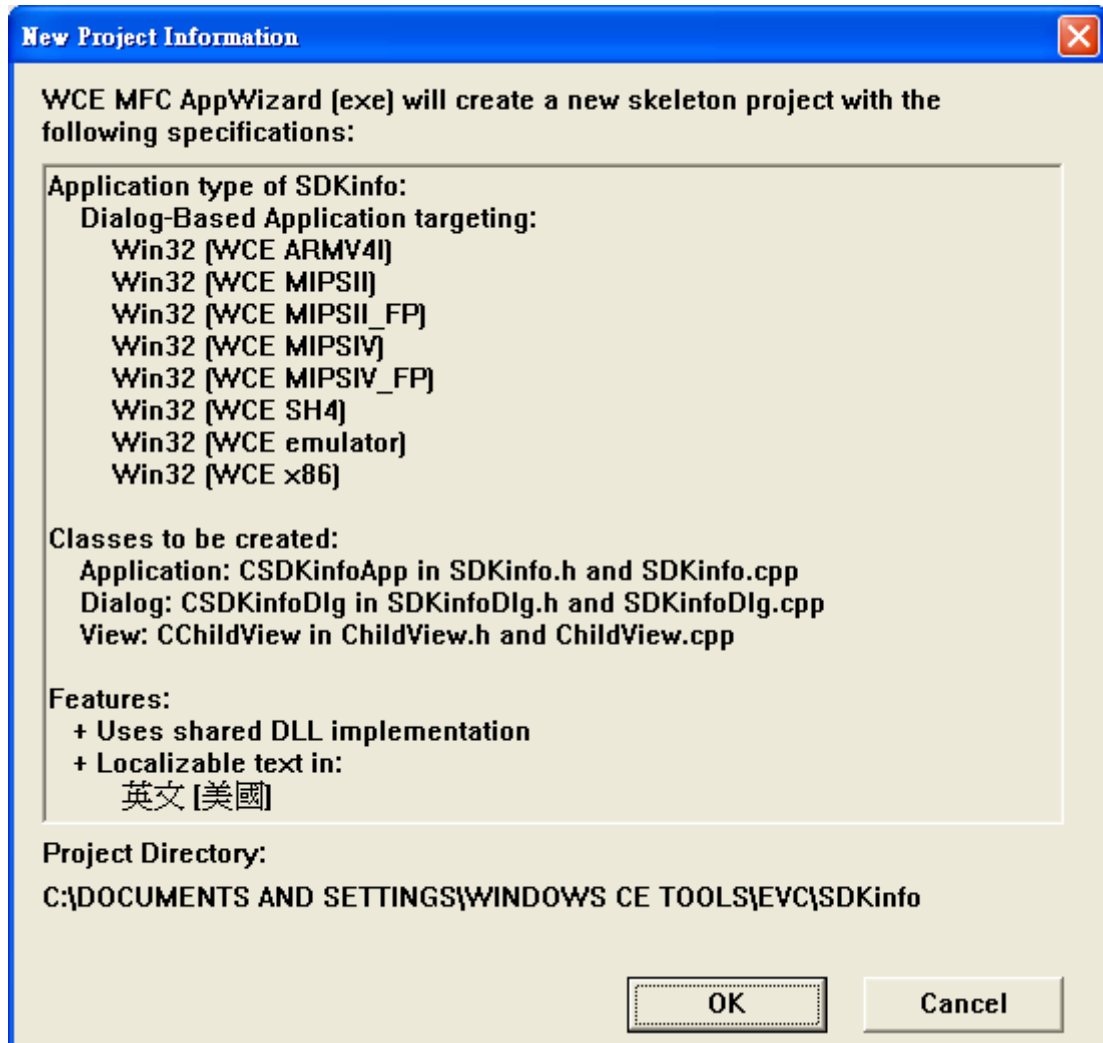

4.6.2. Configure compiler options

On the WCE configuration toolbar, select the “Win32 [WCE ARMV4] Release”

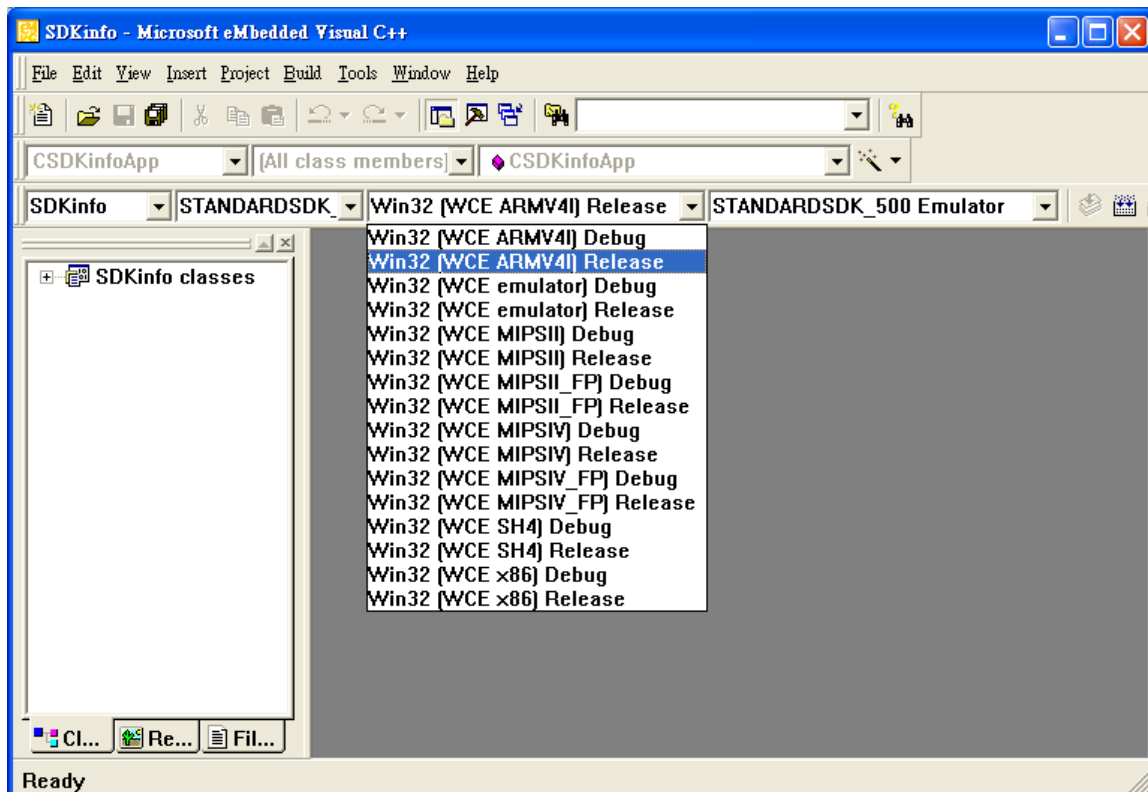

4.6.3. Specify the path for project reference

Step 1: Click the “Options...” command from the “Tools” menu

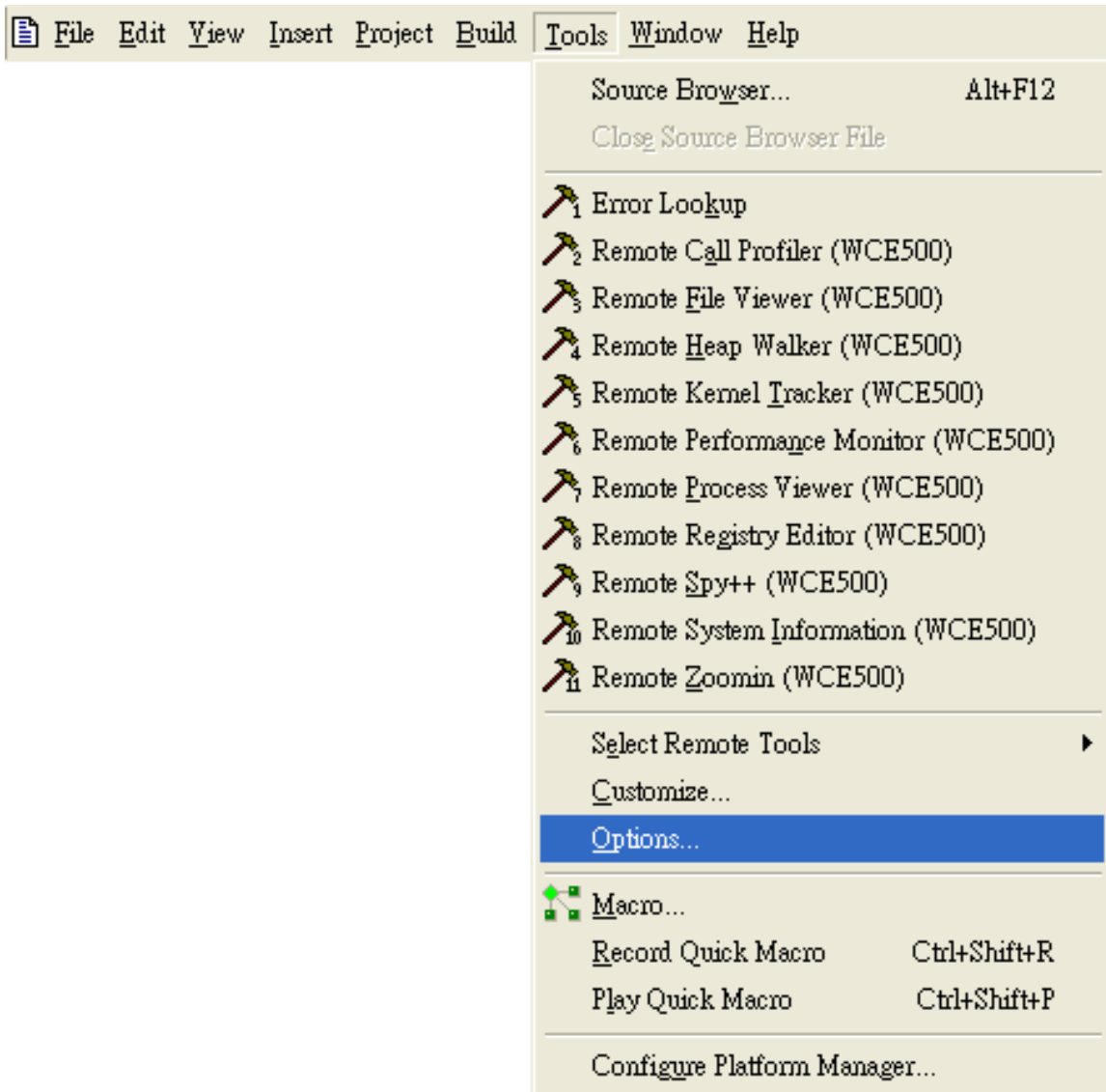

Step 2: In the “Option” dialog, select the “Directories” tab and do the following in this order to specify the header file include path

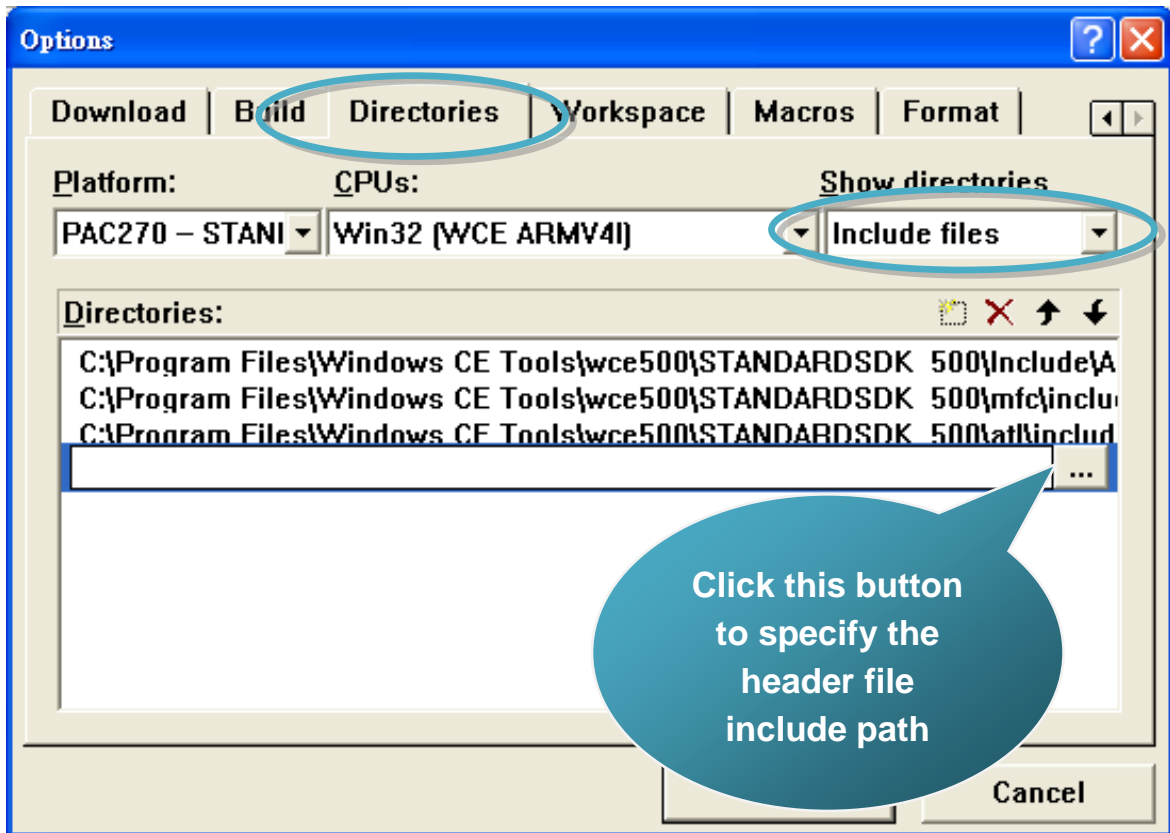

The “Viewpacsdk.h” file can be obtained from:

CD:\Napdos\vp-2000_ce50\SDK\ViewpacSDK\

http://ftp.icpdas.com/pub/cd/winpac/napdos/vp-2000_ce50/sdk/viewpacsdk/

Step 3: In the “Option” dialog, select the “Directories” tab and do the following in this order to specify the library file path

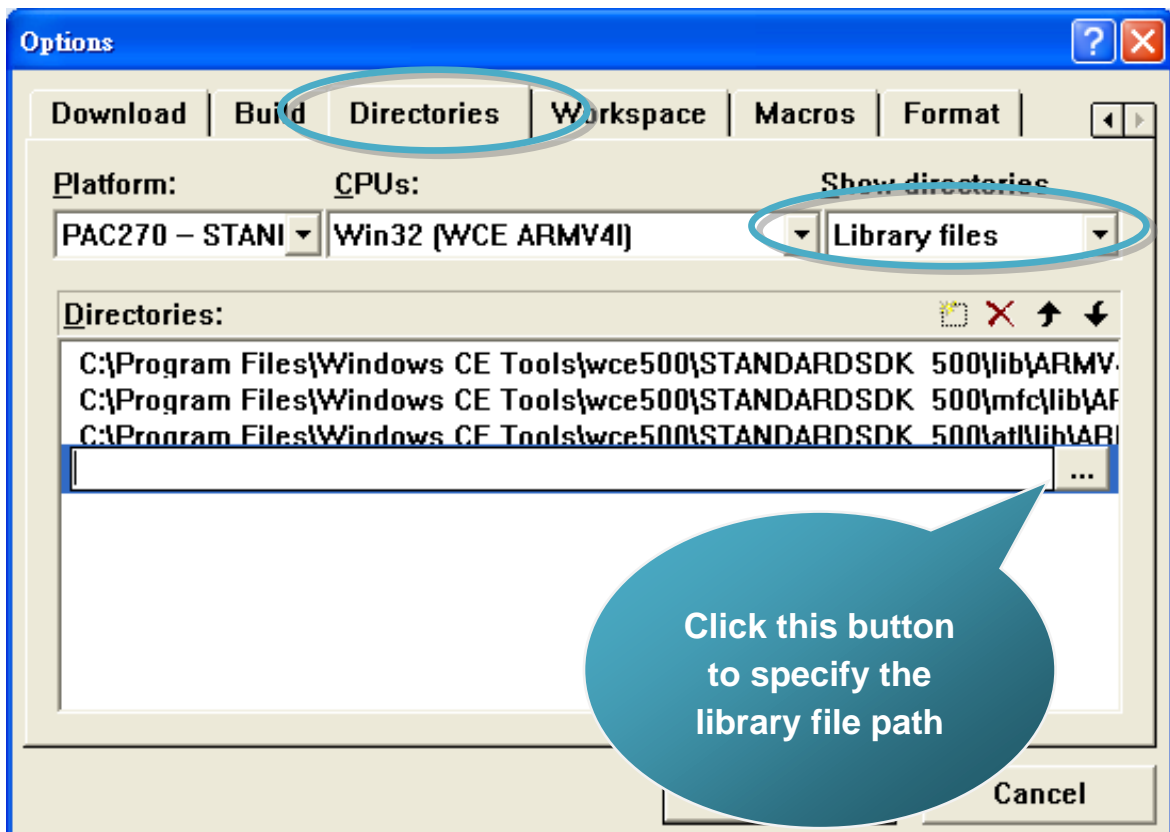

The “ViewPACSDK.lib” file can be obtained from:

CD:\Napdos\vp-2000_ce50\SDK\ViewpacSDK\

http://ftp.icpdas.com/pub/cd/winpac/napdos/vp-2000_ce50/sdk/viewpacsdk/

Step 4: Click the “Settings...” command from the “Project” menu

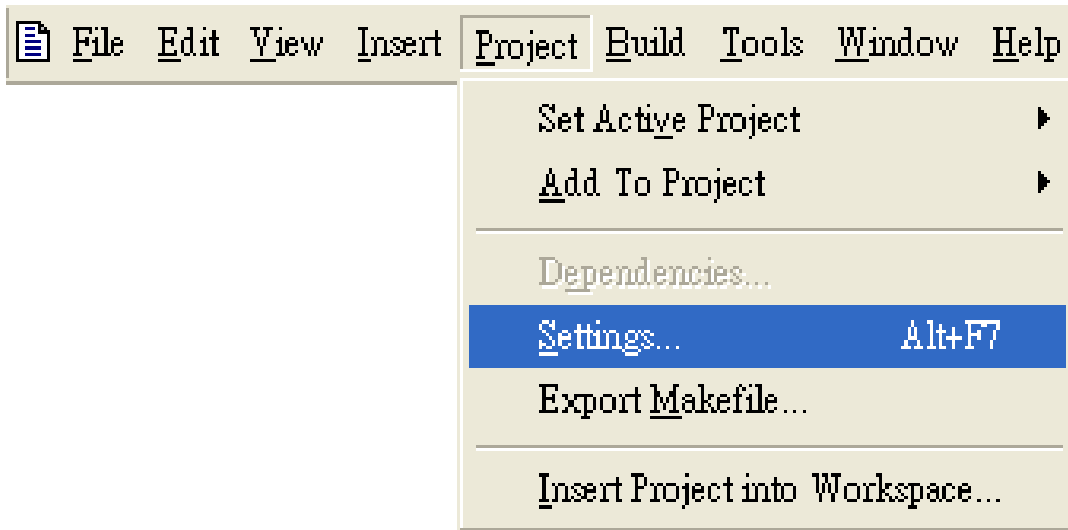

Step 5: In the “Project Settings” dialog box do the following in this order

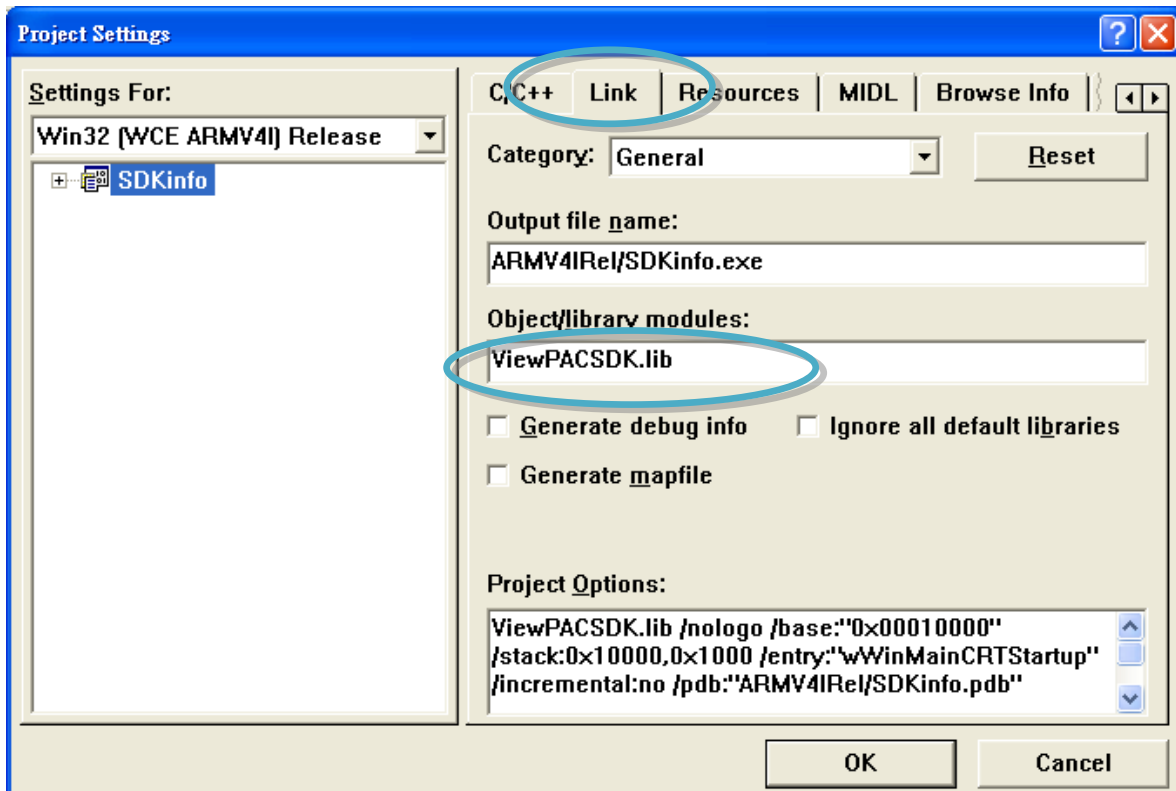

4.6.4. Design and Build an application program

Step 1: On the “Workspace” window, select the “ResourceView” tab and expand the “dialog” folder, and then double-click the “IDD_DEMO_DIALOG” to open the dialog box



Step 2: Add the “button” object in the “SDKInfo” dialog box

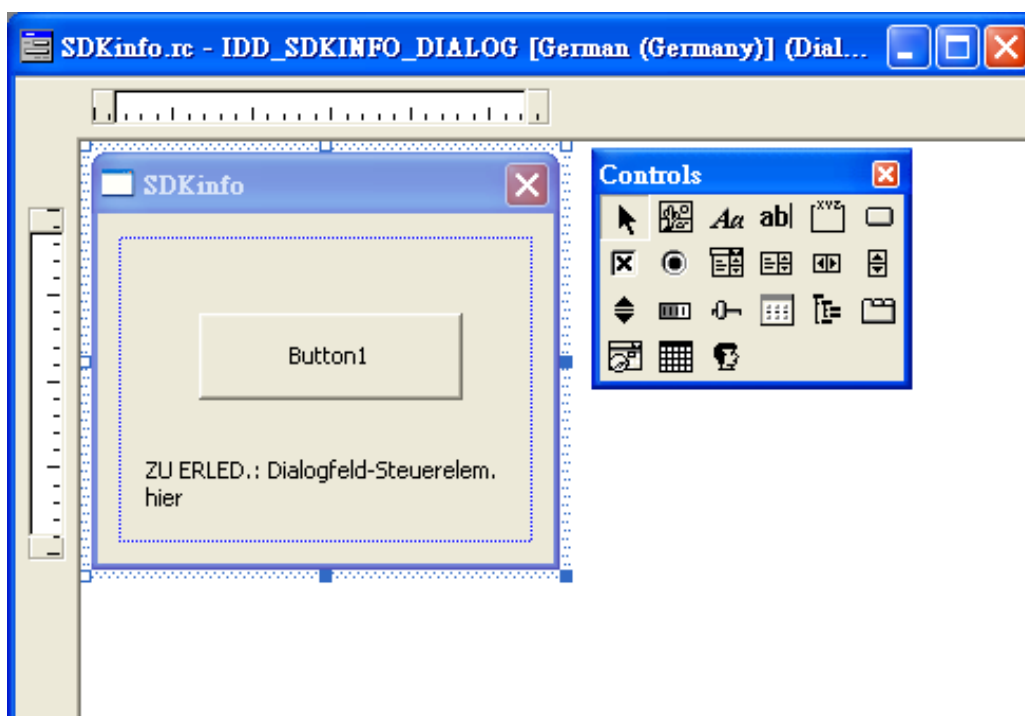

Step 3: In the “SDKinfo” dialog box, right-click the button object and then click the “Properties” command

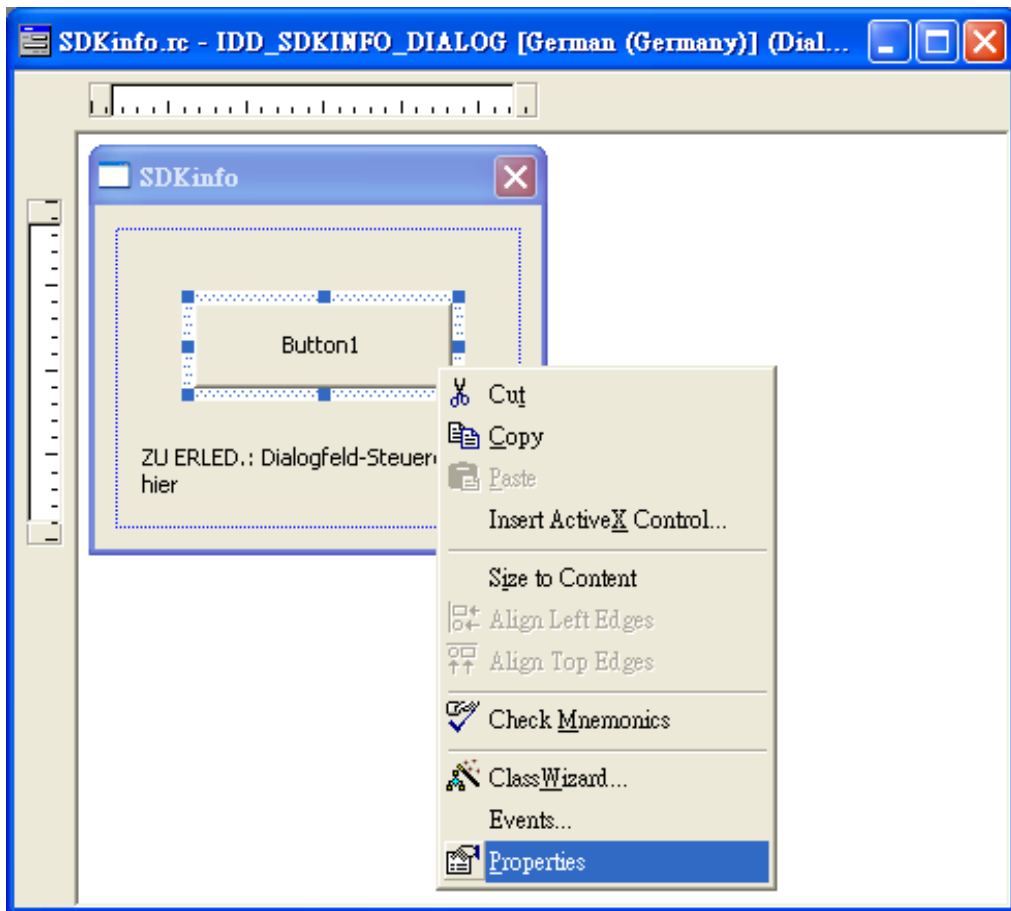

Step 4: Type the “Check the SDK version” in the “Caption” edit box and then click the  “close” button

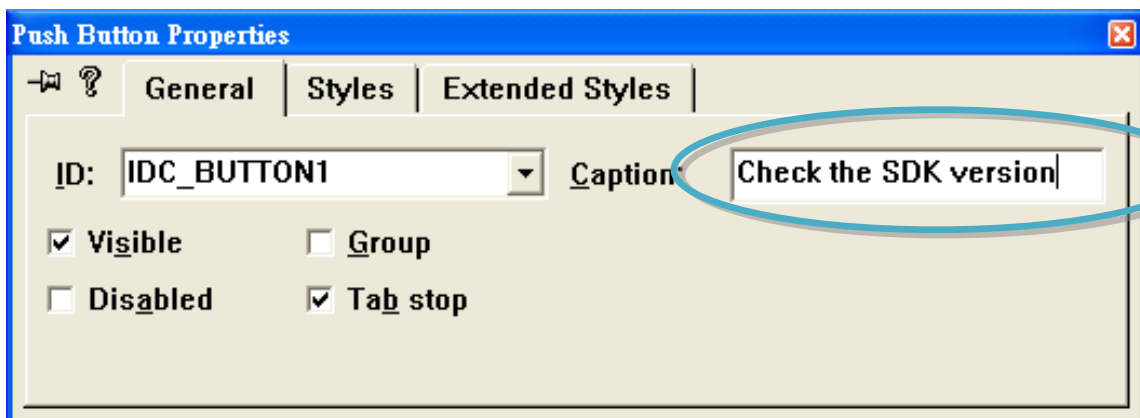

Step 5: In the “SDKinfo” dialog box, double-Click the button object



Step 6: Type the “OnBtnCheckSDK” in the “Member function name” edit box and then click the “OK” button

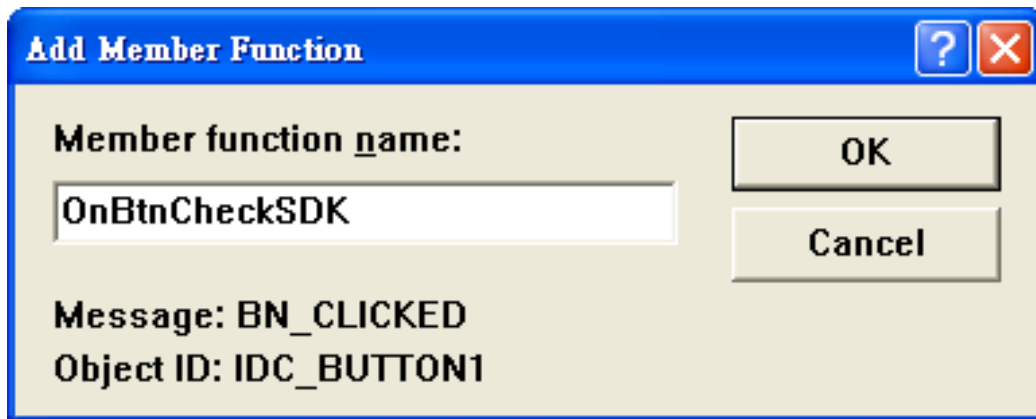

Step 7: Insert the following code into the Editor Window

```
char SDK[32];
TCHAR buf[32];
pac_GetVIEWSDKVersion(SDK);
pac_AnsiToWideString(SDK, buf);
MessageBox(buf, NULL, MB_OK);

return TRUE; // return TRUE unless you set the return value otherwise
}

void CSDKInfoDlg::OnBtnCheckSDK()
{
    // TODO: Add your control notification handler code here
    char SDK[32];
    TCHAR buf[32];
    pac_GetVIEWSDKVersion(SDK);
    pac_AnsiToWideString(SDK, buf);
    MessageBox(buf, NULL, MB_OK);
}
```



Step 8: Insert the “#include “Viewpacsdk.h” and #include “winpacsdk.h”” into the header area

```
// SDKInfoDlg.cpp : implementation file
//

#include "stdafx.h"
#include "SDKInfo.h"
#include "SDKInfoDlg.h"

#include "Viewpacsdk.h"
#include "winpacsdk.h"

#ifdef _DEBUG
#define new DEBUG_NEW
#undef THIS_FILE
static char THIS_FILE[] = __FILE__;
#endif

////////////////////////////////////
// CSDKInfoDlg dialog
```

4.6.5. Execute the application program on ViewPAC

Step 1: On the “Build” menu, click the “Build systeminfo.exe” command

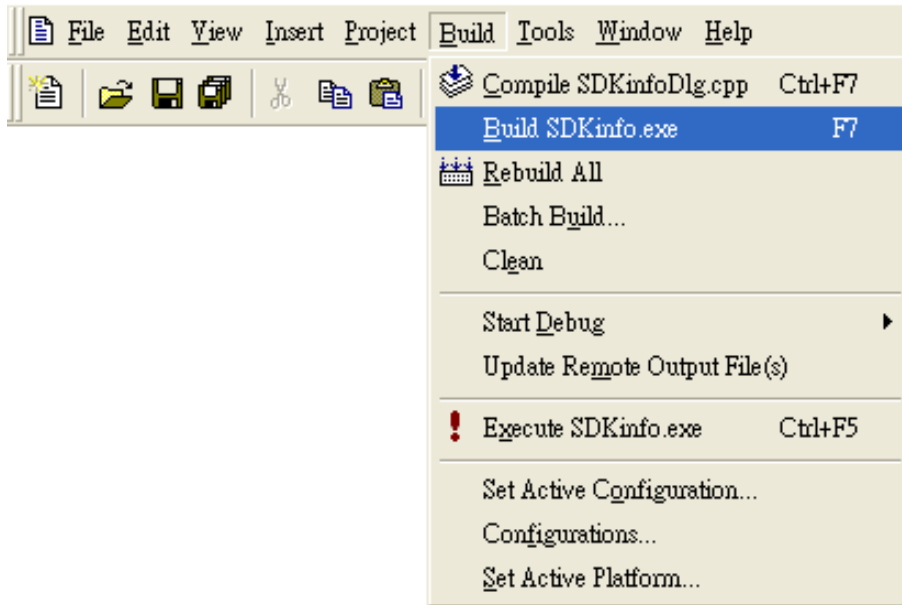

Step 2: Open the web browser and type the IP address to connect the FTP server of ViewPAC

Step 3: Upload the “SDKInfo.exe” application to the ViewPAC via the ViewPAC FTP server



Step 4: On the ViewPAC, execute the uploaded file



5. APIs and Demo References

This chapter introduces demo programs that have been designed for the ViewPAC. You can examine the demo source code, which includes numerous comments, to familiarize yourself with the ViewPAC API. This will allow developing your own applications quickly by modifying these demo programs. The following details the contents of the ViewPAC demo programs.

5.1. Demo programs with C#

The table below describes the ViewPAC demos that have been designed to demonstrate the standard operation features of the ViewPAC.

5.1.1. C# Demo program for WinPAC Standard API

The table below describes the ViewPAC demos that have been designed to demonstrate the standard operation features of the ViewPAC.

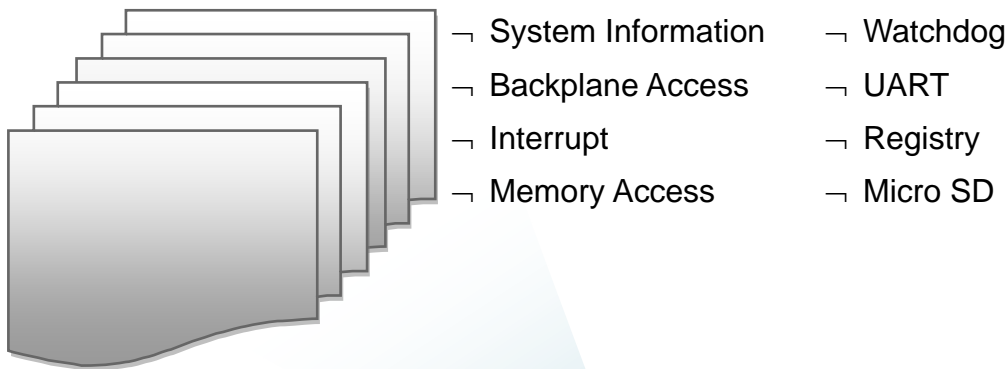

System Operation

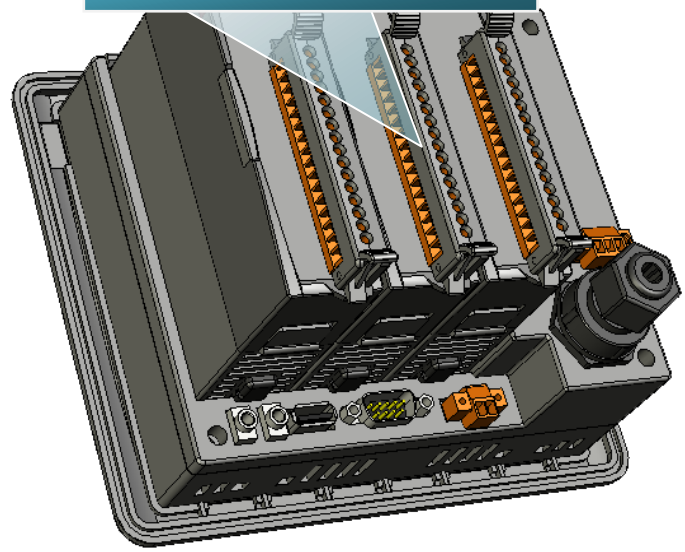

Folder	Demo	Explanation
system	systeminfo	Retrieves information about the OS version, CPU version, SDK version, etc.

Folder	Demo	Explanation
backplane	backplaneinfo	Retrieves information about the DIP switch, backplane ID and slot count.
memoryaccess	memory	Shows how to read/write date values from/to EEPROM
	battery_backup_sram	Shows how to read or write to the battery backup
watchdog	watchdog	Displays how the watchdog operate
microsd	microsd_management	Shows how to enables/disables Micro SD
registry	registry	Shows how to read/write date values from/to registry
UART	diag	Shows how to read the name of local I/O modules via UART

For C# application, these demo programs can be obtained from:

CD:\Napdos\wp-8x4x_ce50\Demo\WinPAC\DotNET\C#.NET\Standard\

ftp://ftp.icpdas.com/pub/cd/winpac/napdos/wp-8x4x_ce50/demo/winpac/dotnet/c%23.net/standard/

5.1.2. C# Demo program for PAC IO API

The table below describes the ViewPAC demos that have been designed to demonstrate the expansion I/O module features of the ViewPAC.

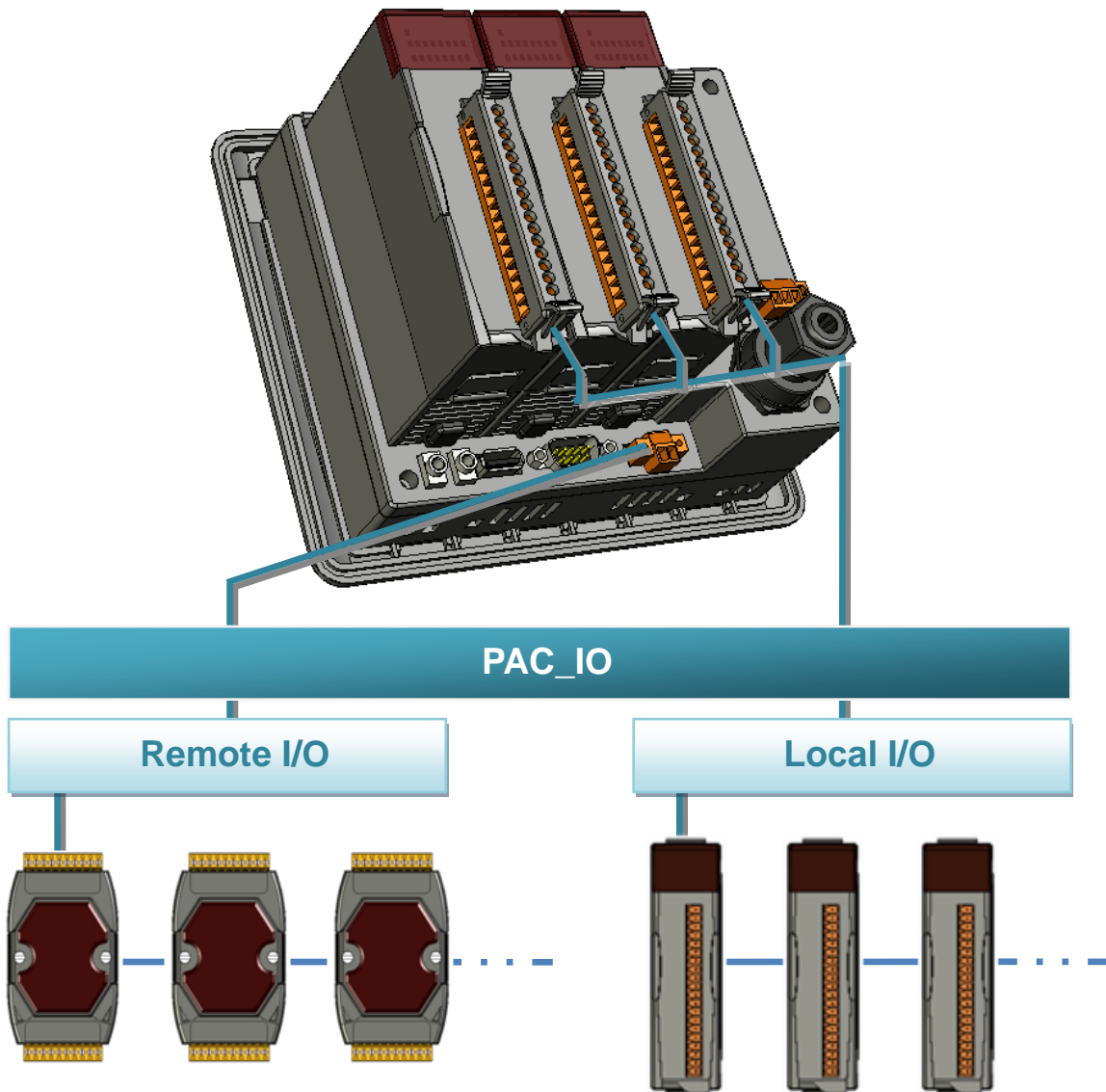

Folder	Demo	Explanation
Local	find_io	Shows how to retrieve the module names and types which plugged in the ViewPAC.

Folder	Demo	Explanation
	8k_di	Shows how to read the DI values of DI module. This demo program is used by 8K series DI modules.
	8k_do	Shows how to write the DO values to DO module. This demo program is used by 8K series DO modules.
	8k_dio	Shows how to read the DI and the DO values of the DIO module. This demo program is used by 8K series DIO modules.
	87k_basic	Shows how to send/receive a command/response application. This demo program is used by 87K series modules.
	87K_demo	Shows how use UART API and the IO modules located as slots. This demo program is used by 87K series modules.
	87k_ai	Shows how to read the AI values of AI module. This demo program is used by 87K series AI modules.
	87k_ao	Shows how to write the AO values to AO module. This demo program is used by 87K series AO modules.
	87k_di	Shows how to read the DI values of DI module. This demo program is used by 87K series DI modules.
	87k_do	Shows how to write the DO values to DO module. This demo program is used by 87K series DO modules.
	87k_dio	Shows how to read the DI and the DO values of the DIO module. This demo program is used by 87K series DIO modules.
	Remote	7k87k_basic
7k87k_ai		Shows how to read the AI values of AI module. This demo program is used by 7K or 87K series AI modules which connected through a COM port.
7k87k_ao		Shows how to write the AO values to AO module. This demo program is used by 7K or 87K series

Folder	Demo	Explanation
		AI modules which connected through a COM port.
	7k87k_di	Shows how to read the DI values of DI module. This demo program is used by 7K or 87K series AI modules which connected through a COM port.
	7k87k_do	Shows how to write the DO values to DO module. This demo program is used by 7K or 87K series AI modules which connected through a COM port.
	7k87k_dio	Shows how to read the DI and the DO values of the DIO module. This demo program is used by 7K or 87K series AI modules which connected through a COM port.

For C# application, these demo programs can be obtained from:

CD:\Napdos\wp-8x4x_ce50\Demo\WinPAC\DotNET\C#.NET\PAC_IO\

ftp://ftp.icpdas.com/pub/cd/winpac/napdos/wp-8x4x_ce50/demo/winpac/dotnet/c%23.net/pac_io/

5.1.3. C# Demo program for ViewPAC Particular API

The table below describes the ViewPAC demos that have been designed to demonstrate the particular features of the ViewPAC.

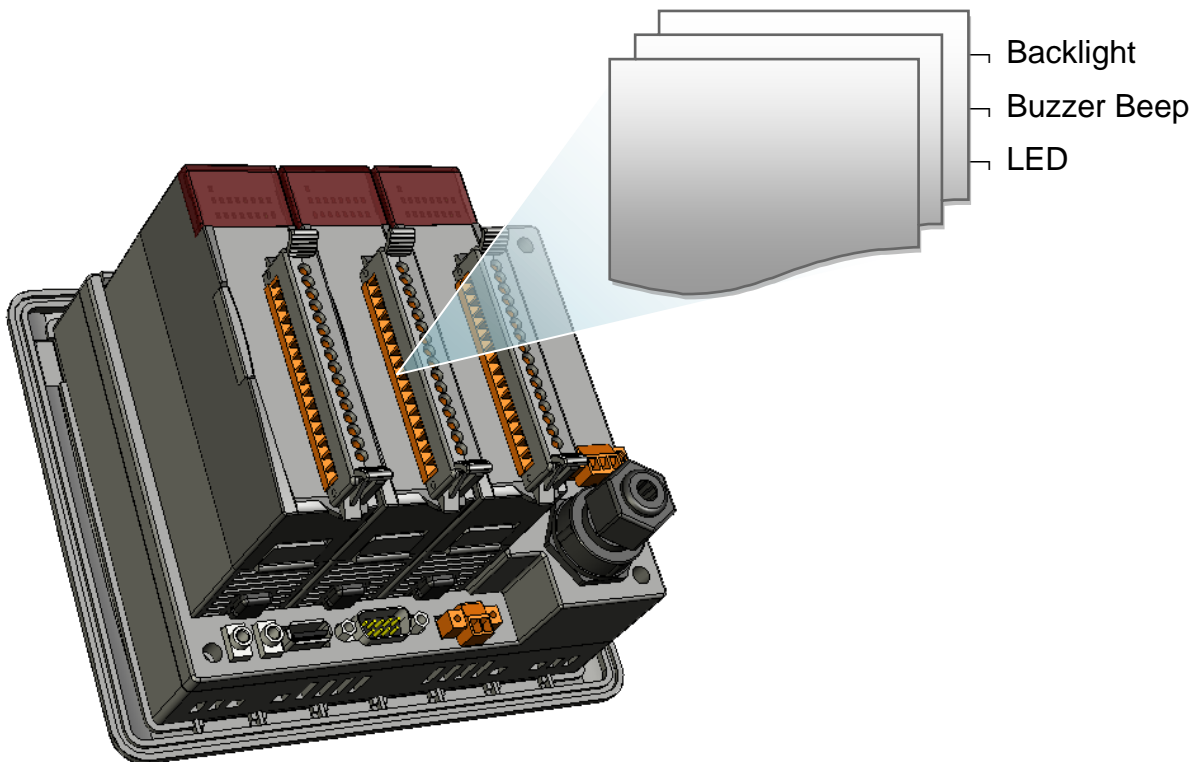

Folder	Demo	Explanation
BuzzerBeep	BuzzerBeep	Shows how to make a simple buzzer beep.
KeyPad	KeyPad	Shows how the KeyPad operates.
LCDBackLight	LCDBackLight	Shows how to control the LCD backlight.
Led	Led	Shows how to control the LEDs.
PlaySound	PlaySound	Shows how to control the microphone-in and earphone-out.

For C# application, these demo programs can be obtained from:

CD:\Napdos\vp-2000_ce50\Demo\ViewPAC\DotNET\C#.NET\

ftp://ftp.icpdas.com/pub/cd/winpac/napdos/vp-2000_ce50/demo/viewpac/dotnet/c%23.net/

5.2. Demo Programs with eMbedded Visual C++

Examples are good way to understand the ViewPAC SDK. The table below describes ViewPAC demos and covers most of the common usages of each ViewPAC API for using eMbedded Visual C++.

5.2.1. eVC Demo program for WinPAC Standard API

The table below describes the ViewPAC demos that have been designed to demonstrate the standard operation features of the ViewPAC.

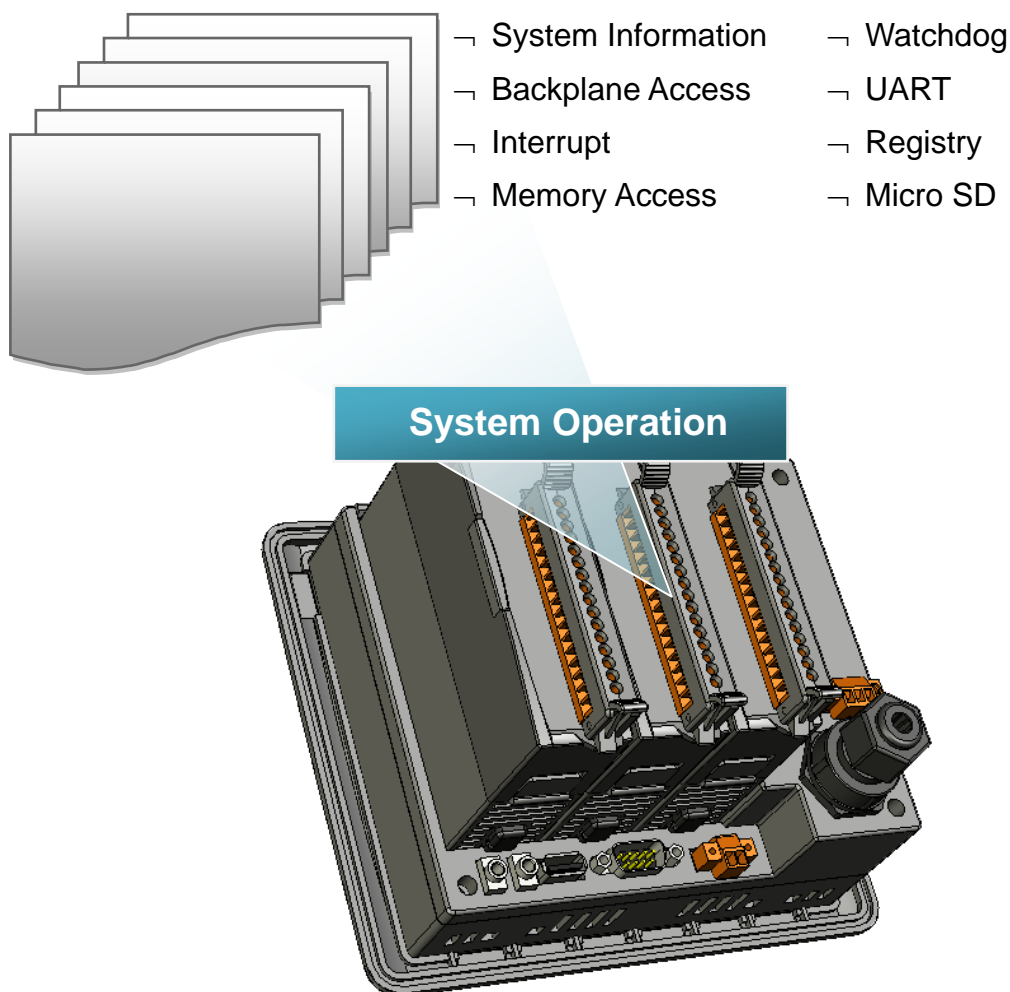

Folder	Demo	Explanation
system	systeminfo	Retrieves information about the OS version, CPU version, SDK version, etc.
backplane	backplaneinfo	Retrieves information about the DIP

Folder	Demo	Explanation
		switch, backplane ID and slot count.
memoryaccess	memory	Shows how to read/write date values from/to EEPROM
	battery_backup_sram	Shows how to read or write to the battery backup
watchdog	watchdog	Displays how the watchdog operate
microsd	microsd_management	Shows how to enables/disables Micro SD
registry	registry	Shows how to read/write date values from/to registry
UART	diag	Shows how to read the name of local I/O modules via UART

For C# application, these demo programs can be obtained from:

CD:\Napdos\wp-8x4x_ce50\Demo\WinPAC\DotNET\C#.NET\Standard\

ftp://ftp.icpdas.com/pub/cd/winpac/napdos/wp-8x4x_ce50/demo/winpac/dotnet/c%23.net/standard/

5.2.2. eVC Demo program for PAC IO API

The table below describes the ViewPAC demos that have been designed to demonstrate the expansion I/O module features of the ViewPAC.

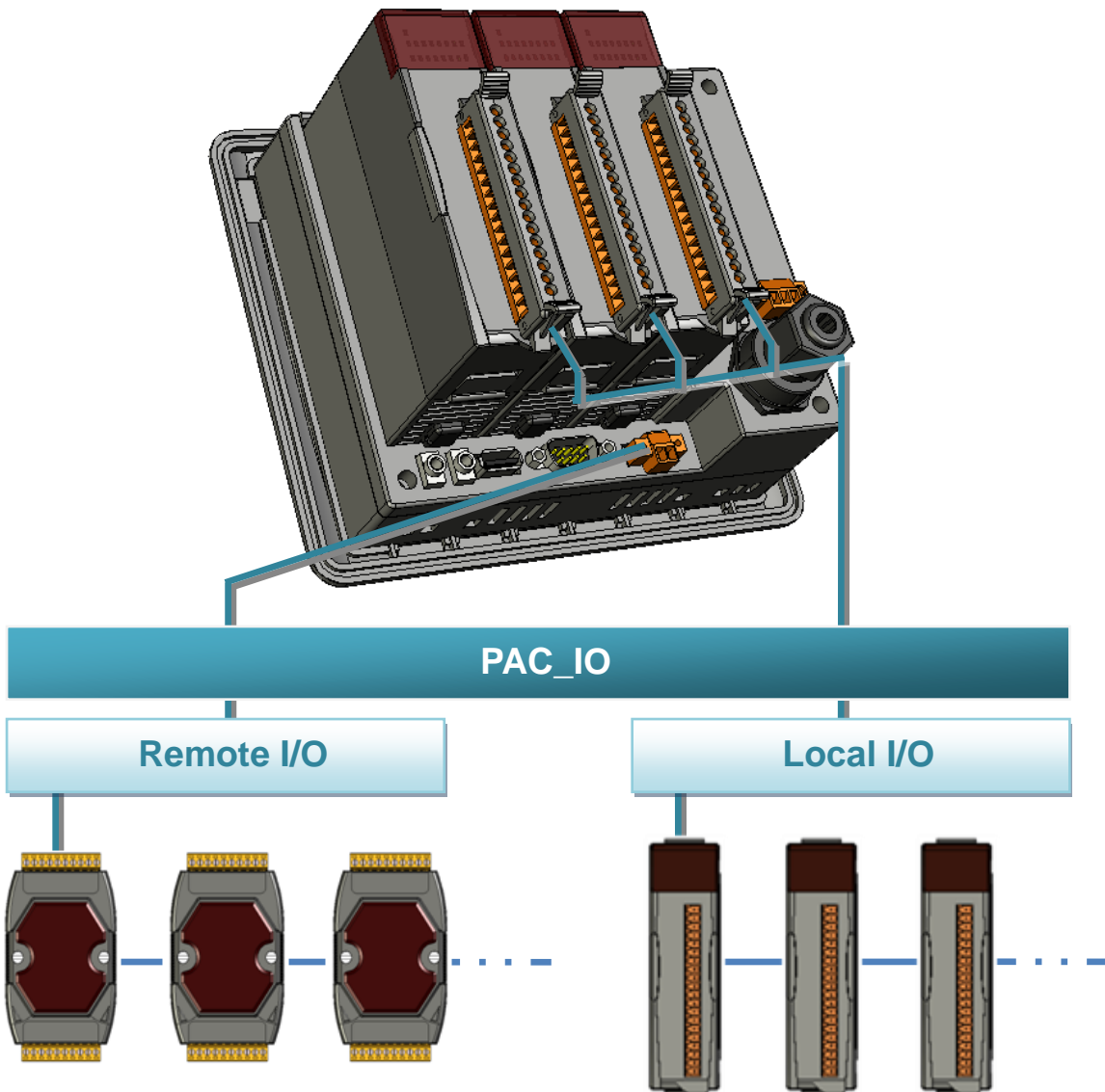

Folder	Demo	Explanation
Local	find_io	Shows how to retrieve the module names and types which plugged in the ViewPAC.
	8k_di	Shows how to read the DI values of DI module. This demo program is used by 8K series DI modules.

Folder	Demo	Explanation
	8k_do	Shows how to write the DO values to DO module. This demo program is used by 8K series DO modules.
	8k_dio	Shows how to read the DI and the DO values of the DIO module. This demo program is used by 8K series DIO modules.
	87k_basic	Shows how to send/receive a command/response application. This demo program is used by 87K series modules.
	87K_demo	Shows how use UART API and the IO modules located as slots. This demo program is used by 87K series modules.
	87k_ai	Shows how to read the AI values of AI module. This demo program is used by 87K series AI modules.
	87k_ao	Shows how to write the AO values to AO module. This demo program is used by 87K series AO modules.
	87k_di	Shows how to read the DI values of DI module. This demo program is used by 87K series DI modules.
	87k_do	Shows how to write the DO values to DO module. This demo program is used by 87K series DO modules.
	87k_dio	Shows how to read the DI and the DO values of the DIO module. This demo program is used by 87K series DIO modules.
Remote	7k87k_basic	Shows how to send/receive a command/response application. This demo program is used by 7K or 87K series AI modules which connected through a COM port.
	7k87k_ai	Shows how to read the AI values of AI module. This demo program is used by 7K or 87K series AI modules which connected through a COM port.
	7k87k_ao	Shows how to write the AO values to AO module. This demo program is used by 7K or 87K series AI modules which connected through a COM port.
	7k87k_di	Shows how to read the DI values of DI module.

Folder	Demo	Explanation
		This demo program is used by 7K or 87K series AI modules which connected through a COM port.
	7k87k_do	Shows how to write the DO values to DO module. This demo program is used by 7K or 87K series AI modules which connected through a COM port.
	7k87k_dio	Shows how to read the DI and the DO values of the DIO module. This demo program is used by 7K or 87K series AI modules which connected through a COM port.

For C# application, these demo programs can be obtained from:

CD:\Napdos\wp-8x4x_ce50\Demo\WinPAC\DotNET\C#.NET\PAC_IO\

ftp://ftp.icpdas.com/pub/cd/winpac/napdos/wp-8x4x_ce50/demo/winpac/dotnet/c%23.net/pac_io/

5.2.3. eVC Demo program for ViewPAC Particular API

The table below describes the ViewPAC demos that have been designed to demonstrate the particular features of the ViewPAC.

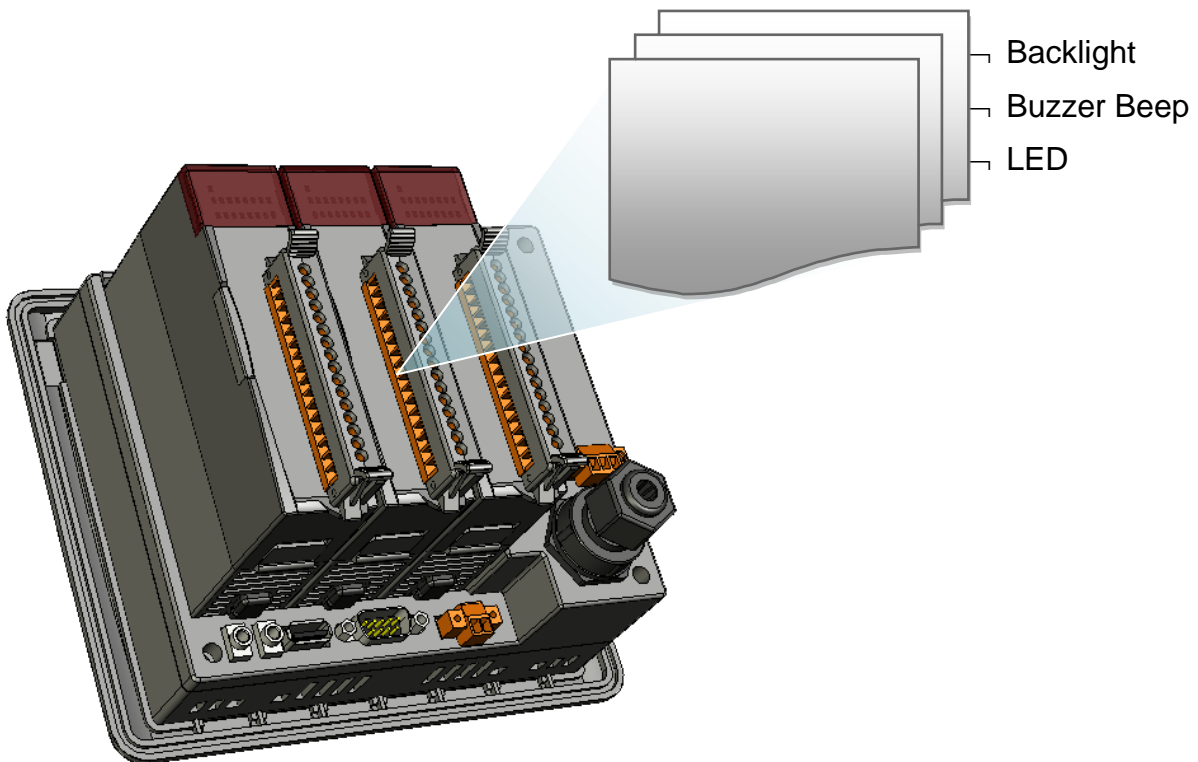

Folder	Demo	Explanation
BuzzerBeep	BuzzerBeep	Shows how to make a simple buzzer beep.
KeyPad	KeyPad	Shows how the KeyPad operate.
LCDBackLight	LCDBackLight	Shows how to control the LCD backlight.
Led	Led	Shows how to control the LEDs.
PlaySound	PlaySound	Shows how to control the microphone-in and earphone-out.

For C# application, these demo programs can be obtained from:

CD:\Napdos\vp-2000_ce50\Demo\ViewPAC\DotNET\C#.NET\

ftp://ftp.icpdas.com/pub/cd/winpac/napdos/vp-2000_ce50/demo/viewpac/dotnet/c%23.net/

6. ViewPAC Updates

This chapter provides instructions on how to upgrade ViewPAC OS and SDK.

ICP DAS will continue to add additional features to ViewPAC SDK and OS in the future, so we advise you to periodically check the ICP DAS web site for the latest updates.

ViewPAC updates services can be divided into the following two main categories:

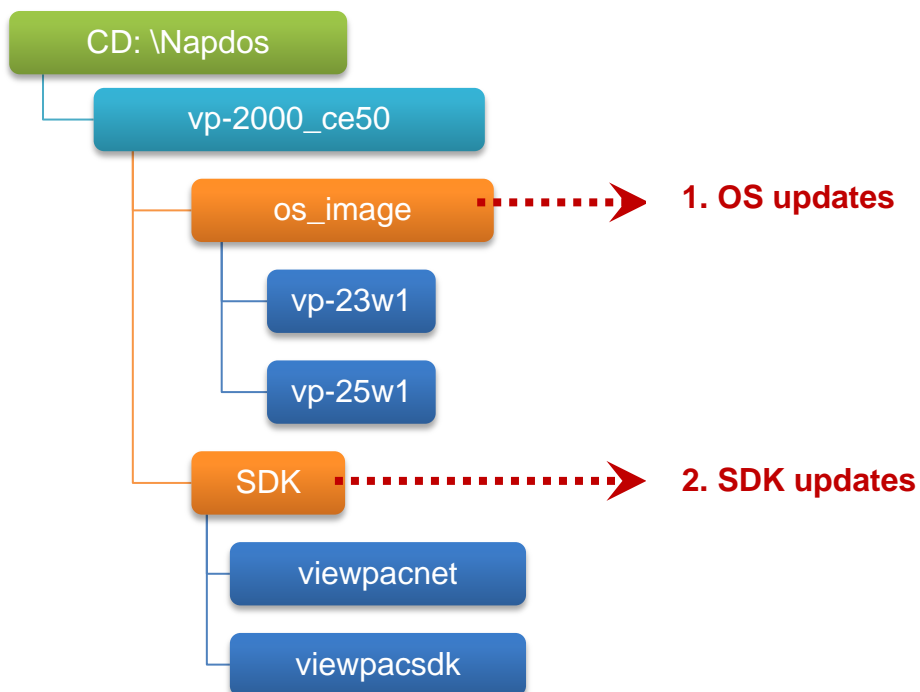

6.1. OS updates

The updates files of OS image are located on:

VP-23W1:

CD:\Napdos\vp-2000_ce50\OS_image\vp-23w1\

VP-25W1:

CD:\Napdos\vp-2000_ce50\OS_image\vp-25w1\

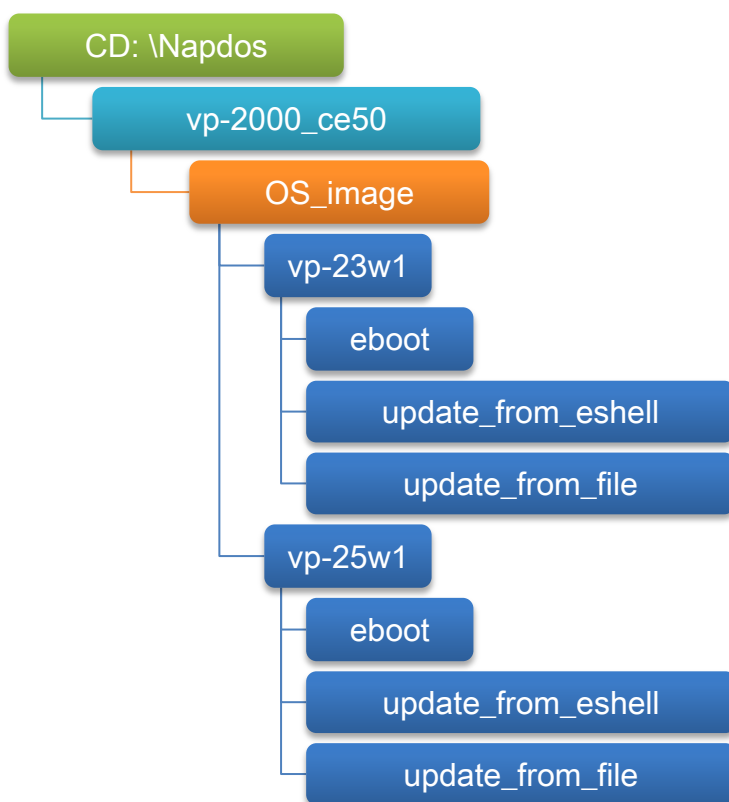

There are two different ways of ViewPAC OS image updates:

- i. ViewPAC OS updates from file
(We recommend that you use this method for quick and easy to update ViewPAC OS image)
- ii. ViewPAC OS updates from eshell

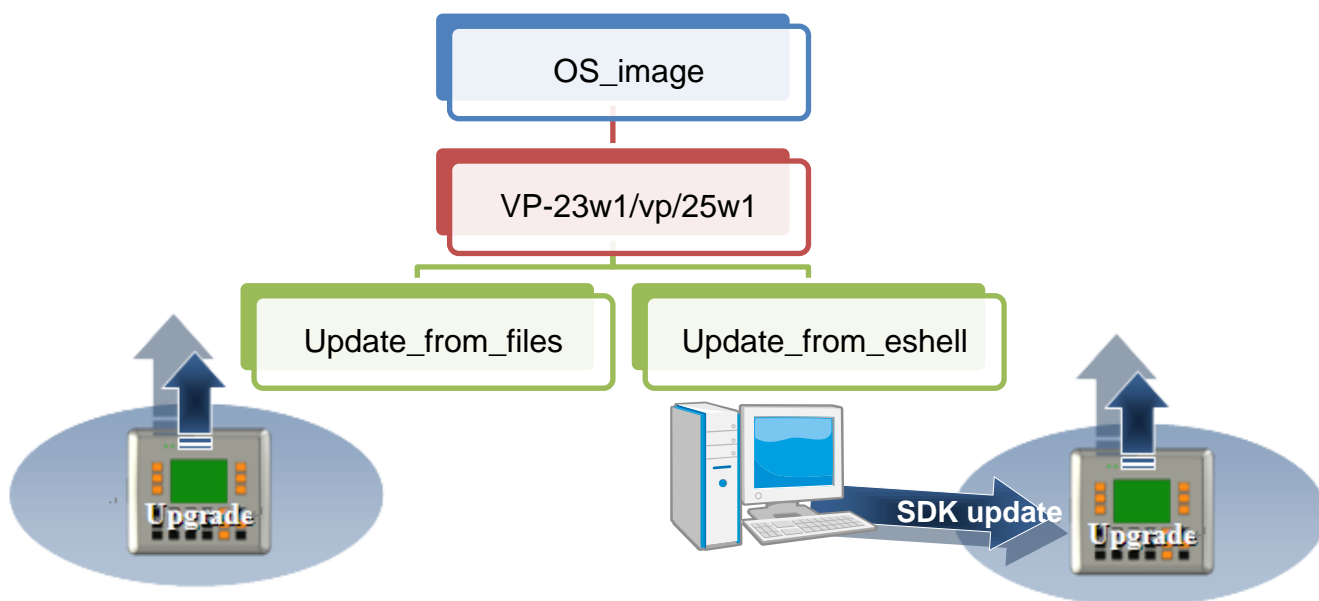

The ViewPAC OS supports multi-language:

- i. en- English
- ii. sc- Simplified Chinese
- iii. tc- Traditional Chinese

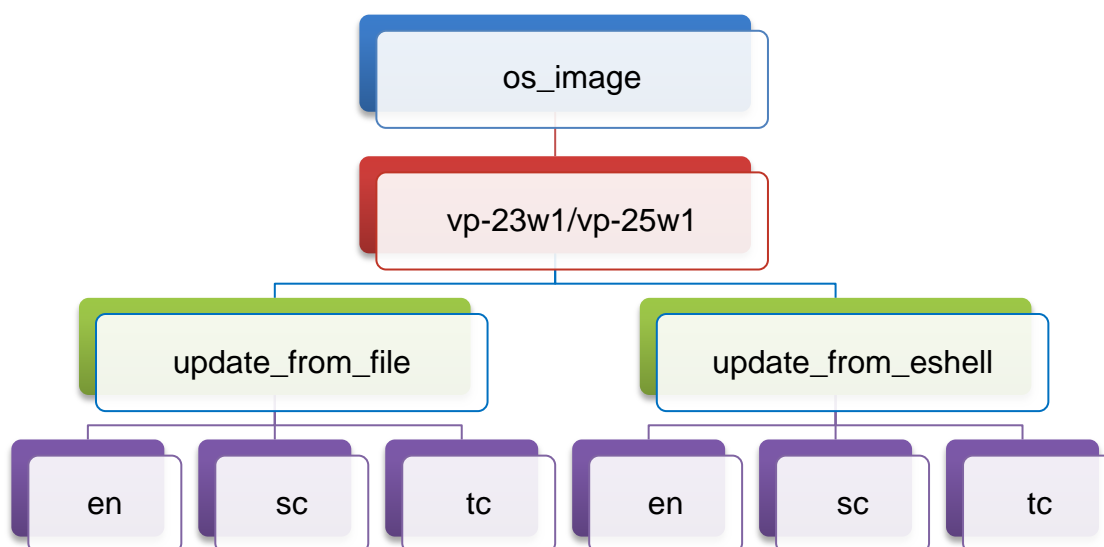

6.1.1. Updating the Boot Loader and the ViewPAC OS image from files

There are two different ways of ViewPAC OS image update:

- i. ViewPAC OS updates from files (Please refer to this section)

We recommend that you use this method for quick and easy to update the ViewPAC OS image

- ii. ViewPAC OS updates from eshell tool (Please refer to section “6.1.2. Updating the ViewPAC OS image from eshell”)

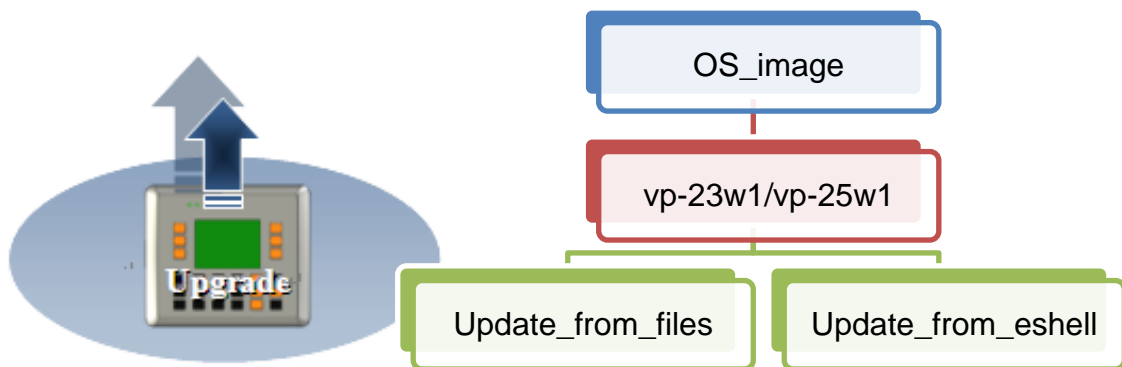

Step 1: Get the latest version of the execute file and the corresponding “autoinit.bat” file and run it on the ViewPAC side

Each folder contains an execute file and a corresponding “autoinit.bat” file.

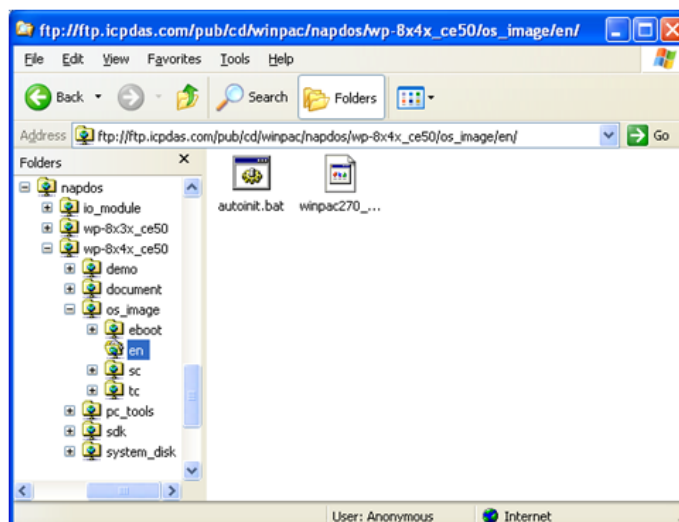

Step 2: Get the latest version of the installation package and download it to ViewPAC, then execute it

For VP23W1:

The latest version of the installation package can be obtained from:

CD:\Napdos\vp-2000_ce50\os_image\vp-23w1\update_from_file\

http://ftp.icpdas.com/pub/cd/winpac/napdos/vp-2000_ce50/os_image/vp-23w1/update_from_file/

VP23xx_YYYYMMDD_Ver.X.X.X.X_XX.exe

1 Release Date	2 Software	3 Language
YYYY- Year	Major version	en - English
MM - Month	Minor version	tc - Traditional Chinese
DD - Day	Build number	sc - Simplified Chinese
	Reversion	

For VP25W1:

The latest version of the installation package can be obtained from:

CD:\Napdos\vp-2000_ce50\os_image\vp-25w1\update_from_file\

http://ftp.icpdas.com/pub/cd/winpac/napdos/vp-2000_ce50/os_image/vp-25w1/update_from_file/

VP25xx_YYYYMMDD_Ver.X.X.X.X_XX.exe

1 Release Date	2 Software	3 Language
YYYY- Year	Major version	en - English
MM - Month	Minor version	tc - Traditional Chinese
DD - Day	Build number	sc - Simplified Chinese
	Reversion	

There are several ways to download the installation package to ViewPAC:

On the ViewPAC, you can download the installation package via an Ethernet connection.

On the host PC, you can download the installation package to ViewPAC via a USB storage device, the removable Micro SD card or FTP server.

The latest version of the ViewPAC OS image file can be obtained from:

CD:\Napdos\wp-8x4x_ce50\OS_image\update_from_file\

http://www.icpdas.com/products/PAC/ViewPAC/download/ViewPAC_8000/download_os_images.htm

Step 3: After execute the installation package, the “Warning !” dialog will display, then click the “OK” button to start the update instructions

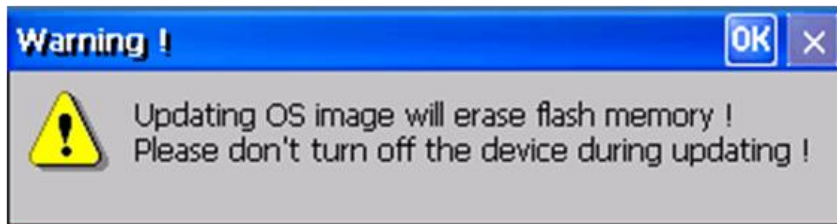

Step 4: On the main dialog, click the “Update Now” button



Step 5: On the “Warning !” dialog, click the “Yes” button

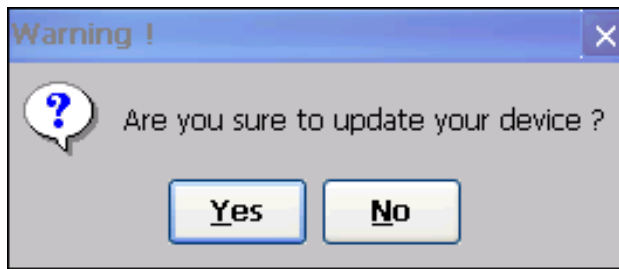

Step 6: On the main dialog, click the “Update Now” button to start installation

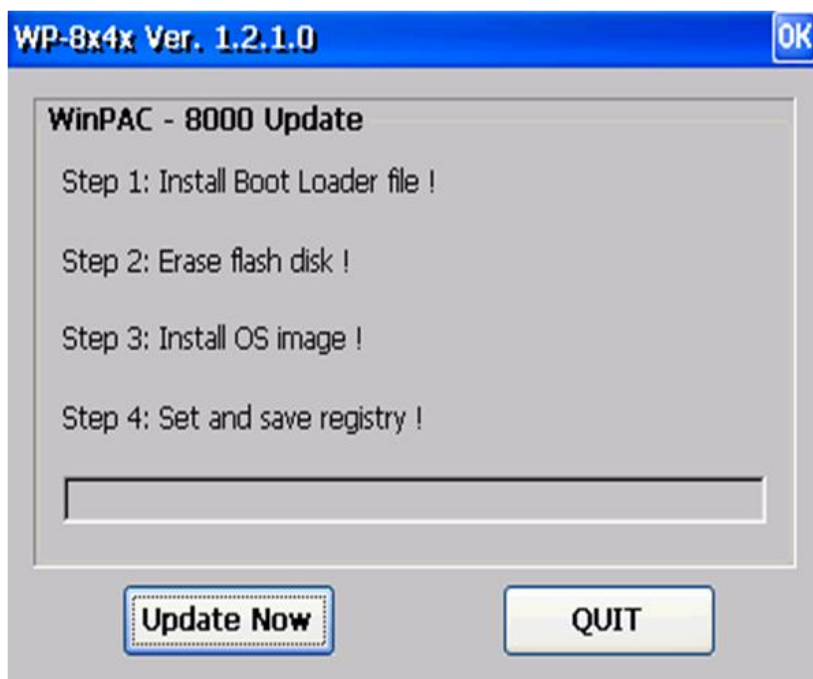

Tips & Warnings



Please never turn the ViewPAC off during OS load. Besides we recommend you turn off all other application before updating.

The installation will perform the following tasks:

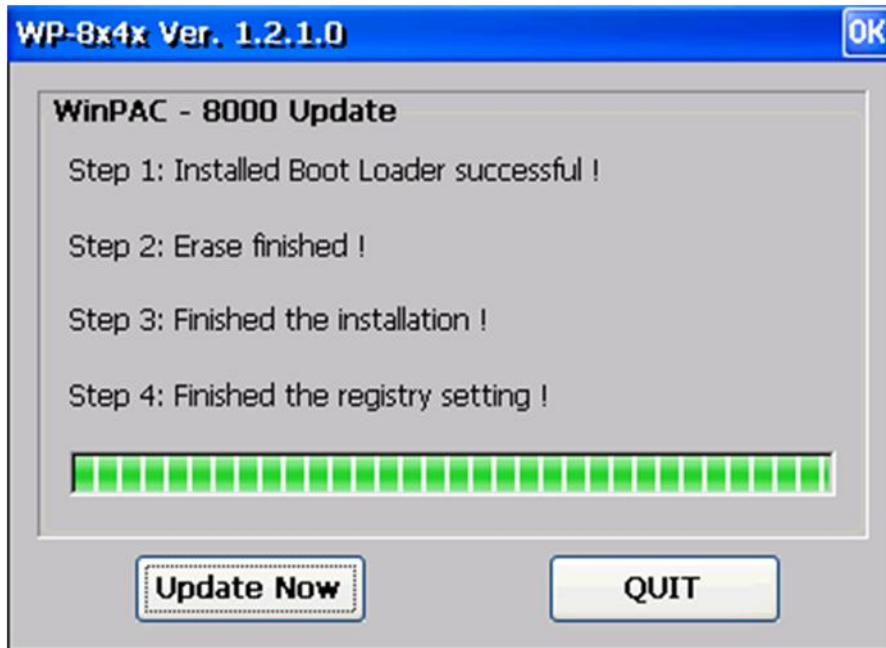

i. Install Boot Loader file

Important Warning



Be careful, if the boot loader broken off in this step and cannot restart in safe mode, you have to send it back to us.

ii. Erase flash disk

iii. Install OS image

iv. Set registry settings to default

Tips & Warnings



This step will reset the registry settings to default, all of your before settings will lost.

Step 7: After completing the above-mentioned tasks, the “Warning !” dialog will appear as follow, after clicking “OK” button to finish updating OS image, be sure the ViewPAC at normal mode

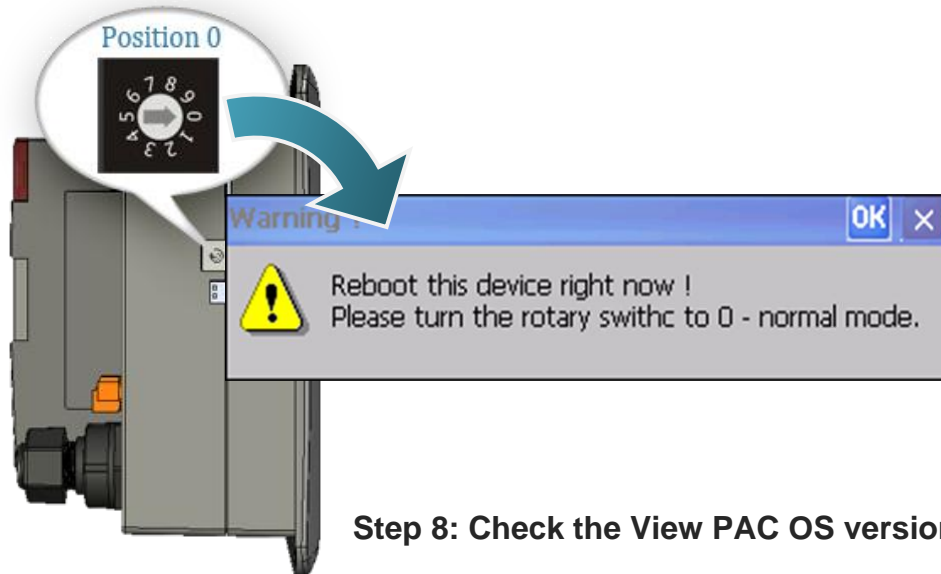

Step 8: Check the View PAC OS version

Start the WinPAC Utility, and then select the “System Information” tab to check the current OS version.

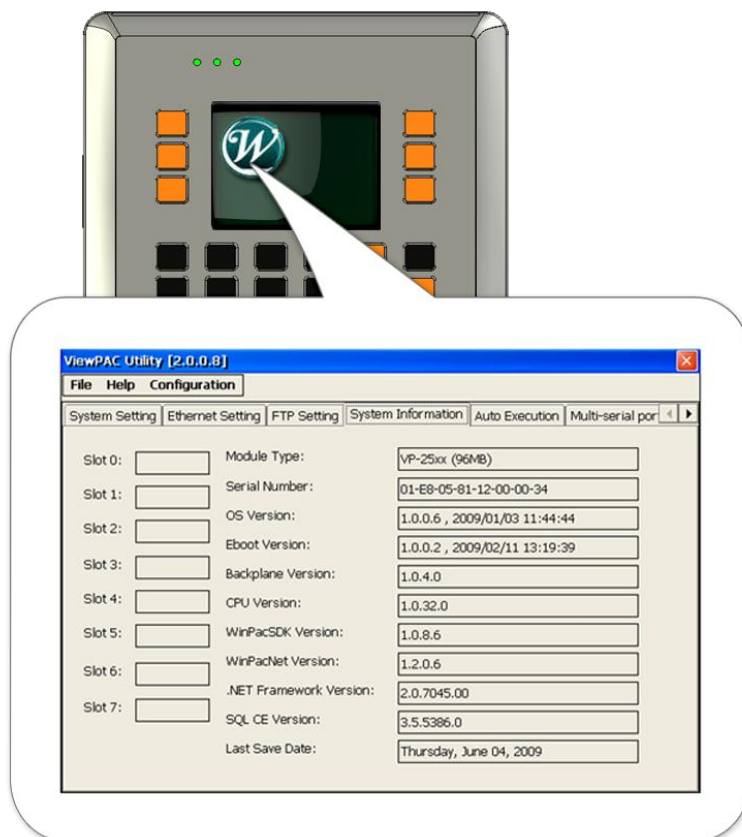

6.1.2. Updating the ViewPAC OS image from eshell

There are two different ways of ViewPAC OS image update:

- i. ViewPAC OS updates from files (Please refer to this section)

We recommend that you use this method for quick and easy to update the ViewPAC OS image

- ii. ViewPAC OS updates from eshell tool (Please refer to section “6.1.2. Updating the ViewPAC OS image from eshell”)

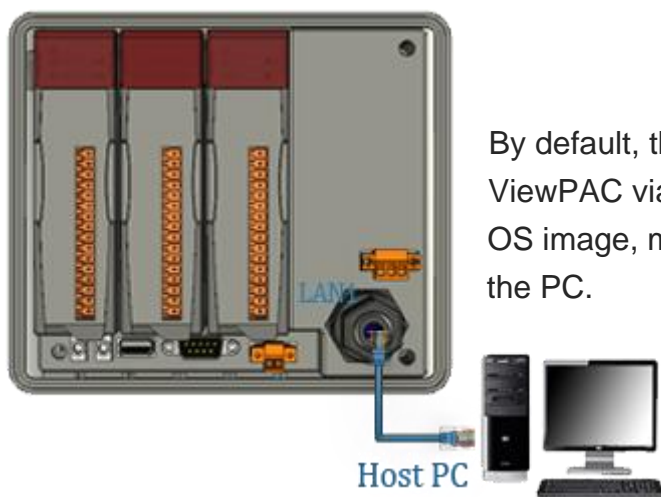
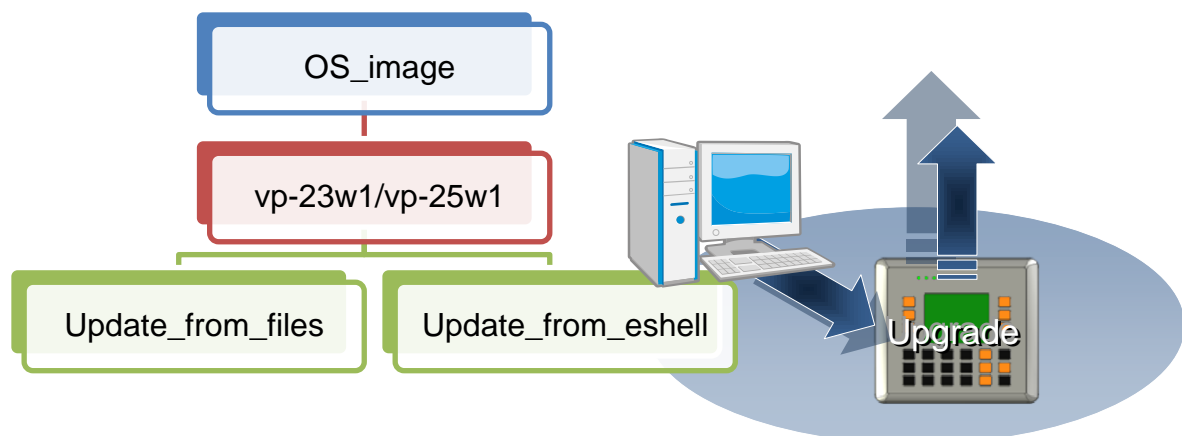

By default, the OS update from Host PC to ViewPAC via Ethernet. Therefore, to update the OS image, make sure Ethernet is connected to the PC.

Step 1: Get the latest version of the ViewPAC OS image

For VP23W1:

The latest version of the installation package can be obtained from:

CD:\Napdos\vp-2000_ce50\os_image\vp-23w1\update_from_Eshell\

http://ftp.icpdas.com/pub/cd/winpac/napdos/vp-2000_ce50/os_image/vp-23w1/update_from_Eshell/



For VP25W1:

The latest version of the installation package can be obtained from:

CD:\Napdos\vp-2000_ce50\os_image\vp-25w1\update_from_Eshell\

http://ftp.icpdas.com/pub/cd/winpac/napdos/vp-2000_ce50/os_image/vp-25w1/update_from_Eshell/



Step 2: Run the ESHELL software on the Host PC



ESHELL you can be obtained at:

CD:\Napdos\wp-8x4x_ce50\PC_Tools\Eshell\

ftp://ftp.icpdas.com/pub/cd/ViewPAC/napdos/wp-8x4x_ce50/pc_tools/eshell/

Step 3: Reboot the ViewPAC at update OS mode

Turn the rotary switch to “3”, and then reboot the ViewPAC.



Step 4: Select the device which you want to update the OS image

After starting the ESHELL software, the “Select Device” dialog will appear, then select the device which you want.

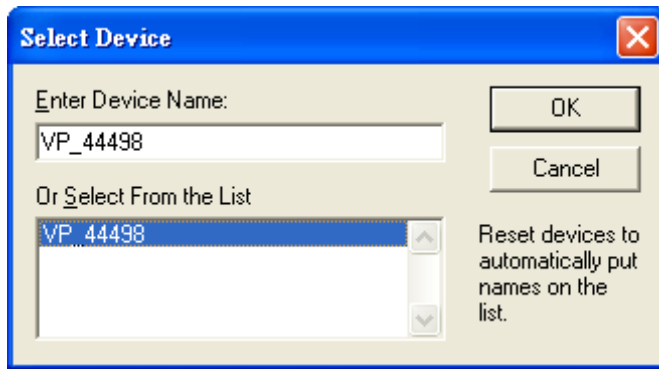

Step 5: Select the latest version of the OS image

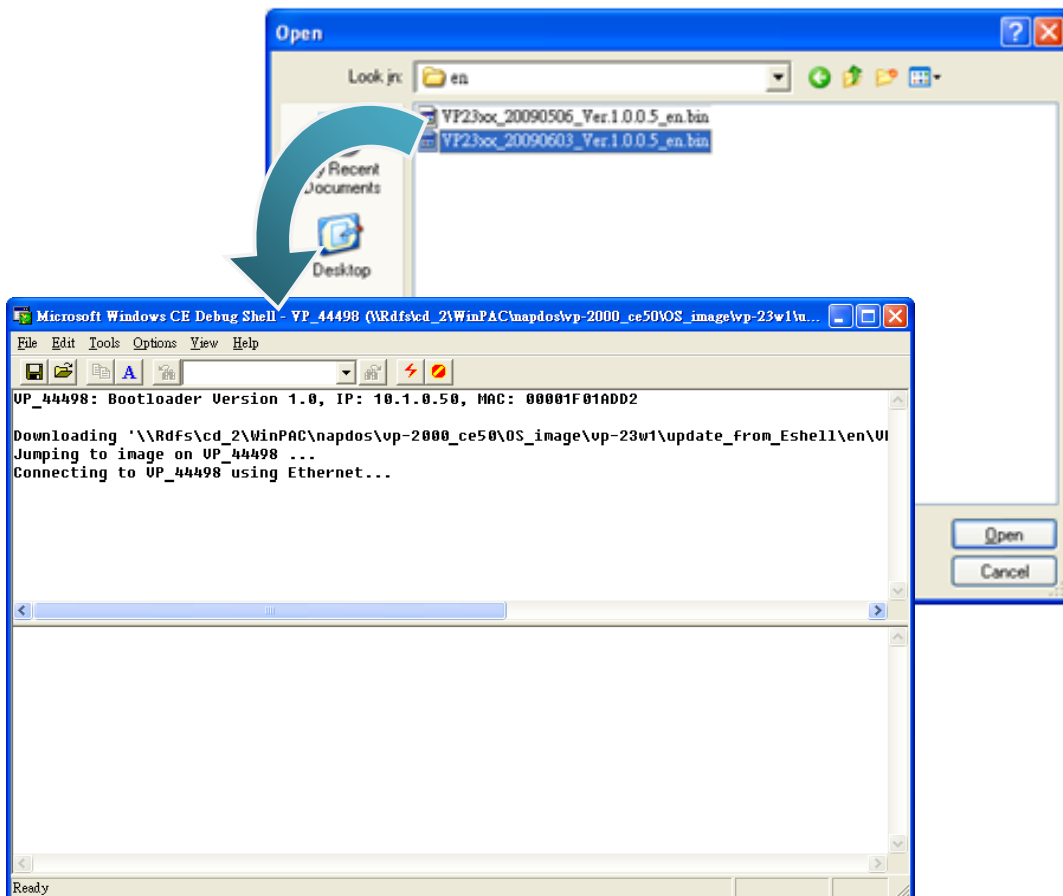

Step 6: Once the procedure is completed, the “Warning !” dialog box will Appear on ViewPAC screen as below shown, before clicking the “Yes” button, you must first turn the rotary switch to the “0” position

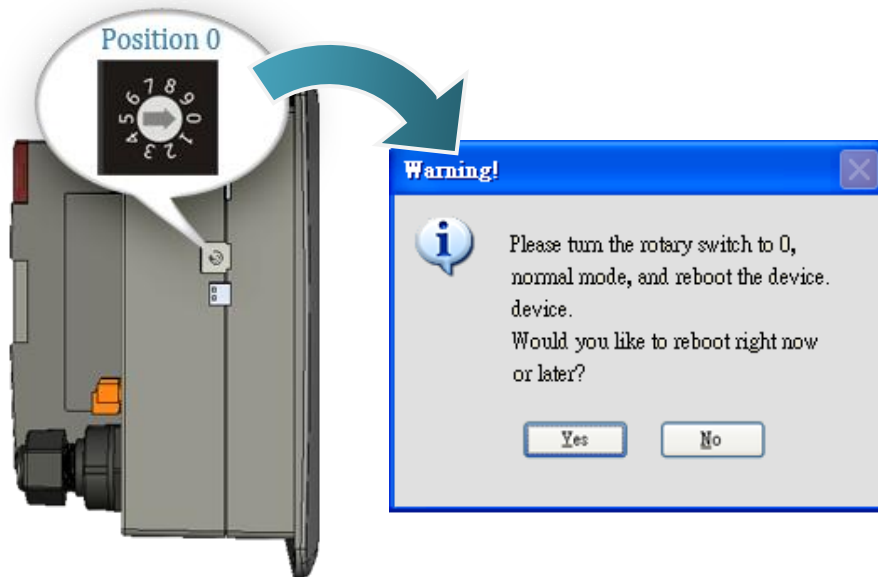

Step 7: Check the ViewPAC OS version

Start the WinPAC Utility, and then select the “System Information” tab to check the current OS version.

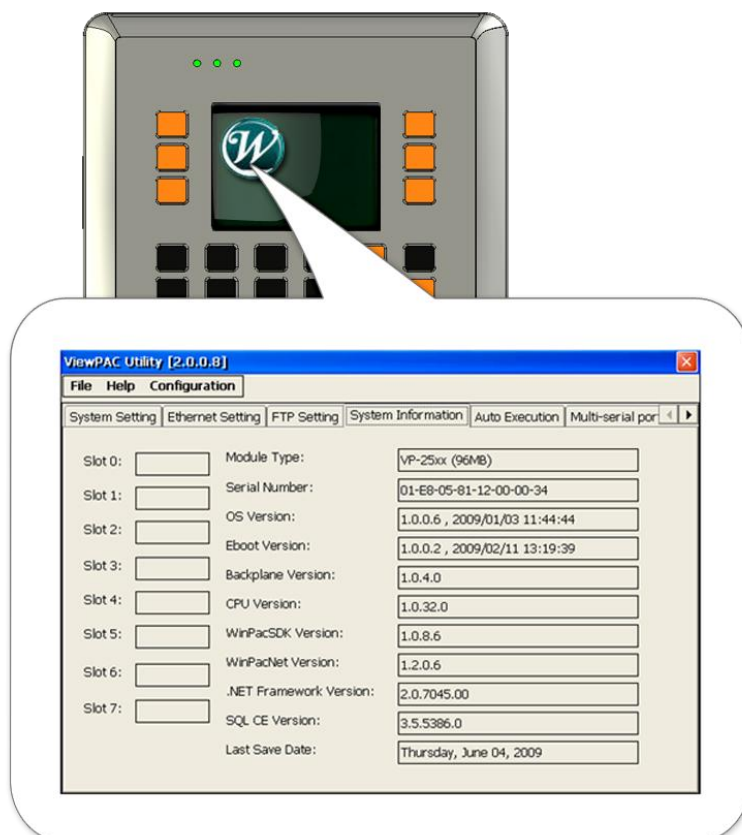

6.2. SDKs Updates

The updates files of SDK image are located on:

CD:\Napdos\vp-2000_ce50\SDK\

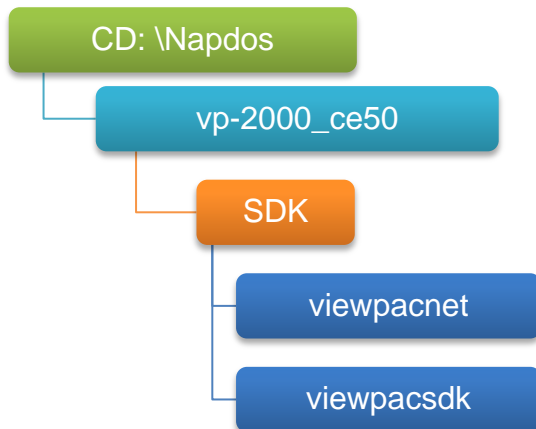

By eVC and donet development tools, the ViewPAC SDK installation is divided into the following two parts:

By eVC and donet development tools, the WinPAC SDK installation is divided into the following two parts:

- i. WinPAC SDK updates for dotnet
- ii. WinPAC SDK updates for eMbedded Visual C++

6.2.1. WinPAC SDK updates for C# or VB.net

To determine the SDK version that is compatibly running on the WinPAC, you can read the “Release Note” which is located under each SDK folder, these files provides important updated information for what we fixed and added.

Step 1: Get the latest version of the C# or VB.net components

The latest version of the C# or VB.net components can be obtained from:

ftp://ftp.icpdas.com/pub/cd/WinPAC/napdos/wp-8x4x_ce50/sdk/WinPACNet/

Step 2: Copy the latest version of DLL to Host PC and WinPAC

The DLL files on Host PC are located at anywhere only the solution can reference it.

The DLL files on WinPAC are located at the same directory as the .exe file.

6.2.2. WinPAC SDK updates for eMbedded Visual C++

To determine the SDK version that is compatibly running on the WinPAC, you can read the “Release Note” which is located under each SDK folder, these files provides important updated information for what we fixed and added.

Step 1: Get the latest version of the eMbedded Visual C++ components

The latest version of the eMbedded Visual C++ components can be obtained from:

ftp://ftp.icpdas.com/pub/cd/WinPAC/napdos/wp-8x4x_ce50/sdk/WinPACSDK/

Step 2: Copy the latest version of header files and libraries to Host PC

The header files are located at:

C:\Program Files\Windows CE Tools\wce500\PAC270\Include

The libraries are located at:

C:\Program Files\Windows CE Tools\wce500\PAC270\Lib

Step 3: Copy the latest version of DLL files to WinPAC

The DLL files are located at:

\System_Disk\ICPDAS\System

7. ViewPAC Download Center

This chapter introduces the WinPAC-8000 Download Center.

Visit the ViewPAC Download Center:

http://www.icpdas.com/products/PAC/viewpac/download/viewpac/download_os_images.htm

The screenshot shows the 'ViewPAC Download Center' website. The main heading is 'ViewPAC Download Center (For WinCE based ViewPAC)'. Below this is a 'Note' section with text about downloading software. A navigation bar contains tabs for 'OS images', 'SDK', 'Utility & Tools', 'Demo', 'Documents', and 'System Disk'. The 'Utility & Tools' tab is selected, showing a sub-heading 'ViewPAC Utility and Tools' and another 'Note'. Below the note is a table for 'ViewPAC Utility' with columns for Version, Last update, Compatibility, HTTP, and FTP. The table shows version 2.0.0.8, last updated in Jun. 2009, compatible with VP-23Wx / VP-25Wx. Below the table is a description of the utility's functions.

ViewPAC Utility			HTTP	FTP
Version	Last update	Compatibility		
2.0.0.8	Jun. 2009	VP-23Wx / VP-25Wx		

Tools to save / view the system information registry and setup the HTTP / FTP path and update non-volatile internal memory within ViewPAC

The following update categories are available from the ViewPAC Download Center.

- ✓ **OS images** Includes updates and the latest version of ViewPAC OS.
- ✓ **ViewPAC SDK** Includes updates and the latest version of each ViewPAC component SDK, such as ViewPAC SDK, NAPOPC_CE5 SDK, Modbus SDK, etc.
- ✓ **Utility & Tools** Includes updates and the latest version for ViewPAC toolkits
- ✓ **Demo** Includes all related ViewPAC demos.
- ✓ **Documents** Includes updates and the latest version for related ViewPAC documents.
- ✓ **System Disk** Includes updates and the latest version for ViewPAC toolkits

Appendix A. I-8K and I-87K Modules

There are 3 slot options to expand local I/O. And the I/O modules can be parallel bus type (high profile I-8K series) and serial bus type (high profile I-87K series).

The difference between them is

Item	I-8K Series	I-87K Series
Communication interface	Parallel bus	Serial bus
Protocol	-	DCON
Communication speed	Fast	Slow
DI latched function	-	Yes
Counter input (for digital input module)	-	Yes (100 Hz)
Power on value	-	Yes
Safe value	-	Yes
Programmable slew-rate for AO module	-	Yes

Appendix B. Application of RS-485 Network

The RS-485 length can be up to 4000 ft or 1.2 km over a single set of twisted-pair cables, if the RS-485 network is over 4000 ft or 1.2Km, the RS-485 repeater must be added to extend the RS-485 network.

B.1. Basic RS-485 Network

The basic component of the RS-485 network consist of a Master Controller (or using a PC as a host controller), and some RS-485 devices.

Tips & Warnings



If PC/Laptop has no COM port, you can use the I-7561 (USB to RS-485 converter) for connection between ViewPAC and PC/Laptop.

Before using the I-7561 converter, you must install the USB driver. The USB driver can be obtained from:

<ftp://ftp.icpdas.com/pub/cd/8000cd/napdos/7000/756x/>

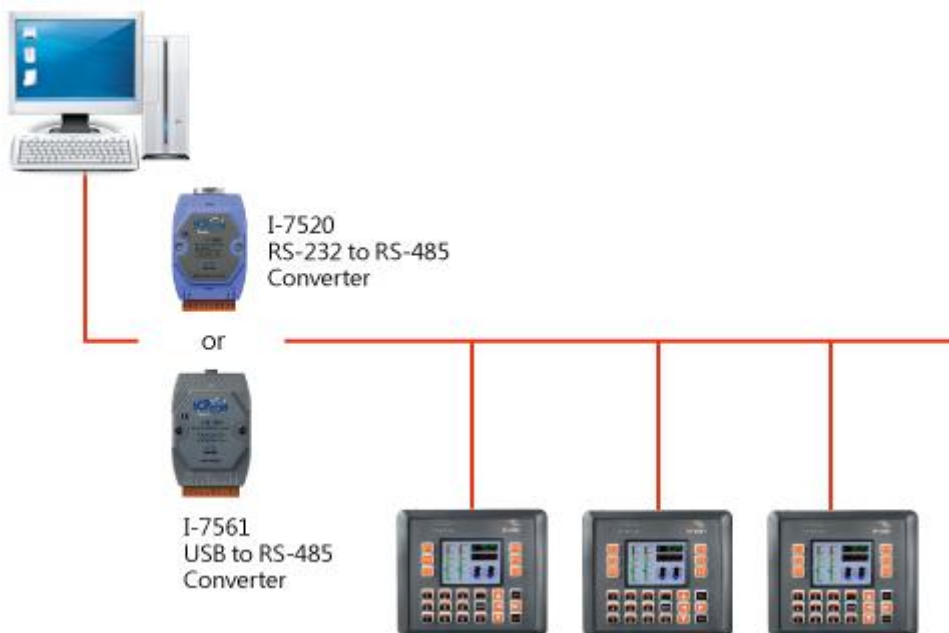

B.2. Daisy Chain RS-485 Network

All RS-485 devices are wired directly to the main network, If the network is up to 1.2 km, it will need a repeater (7510 series) to extend the network length.

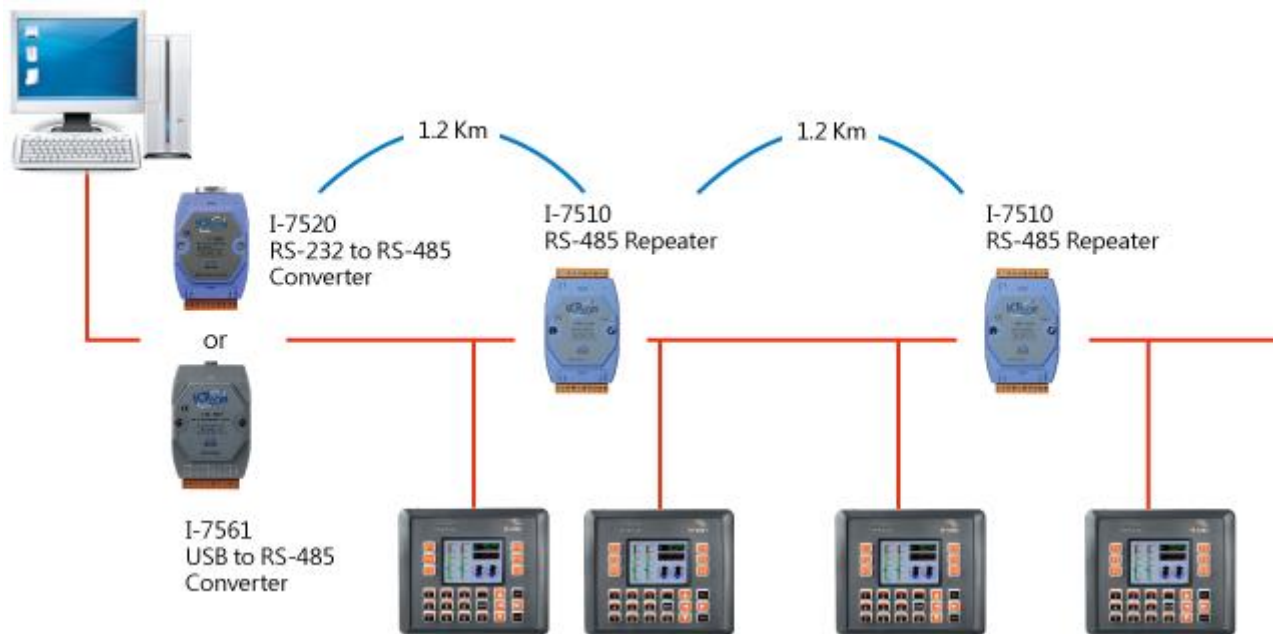

B.3. Star Type RS-485 Network

There are branches along the main network. In this case, it is better to have a repeater to isolate or filter the noise that is made by devices.

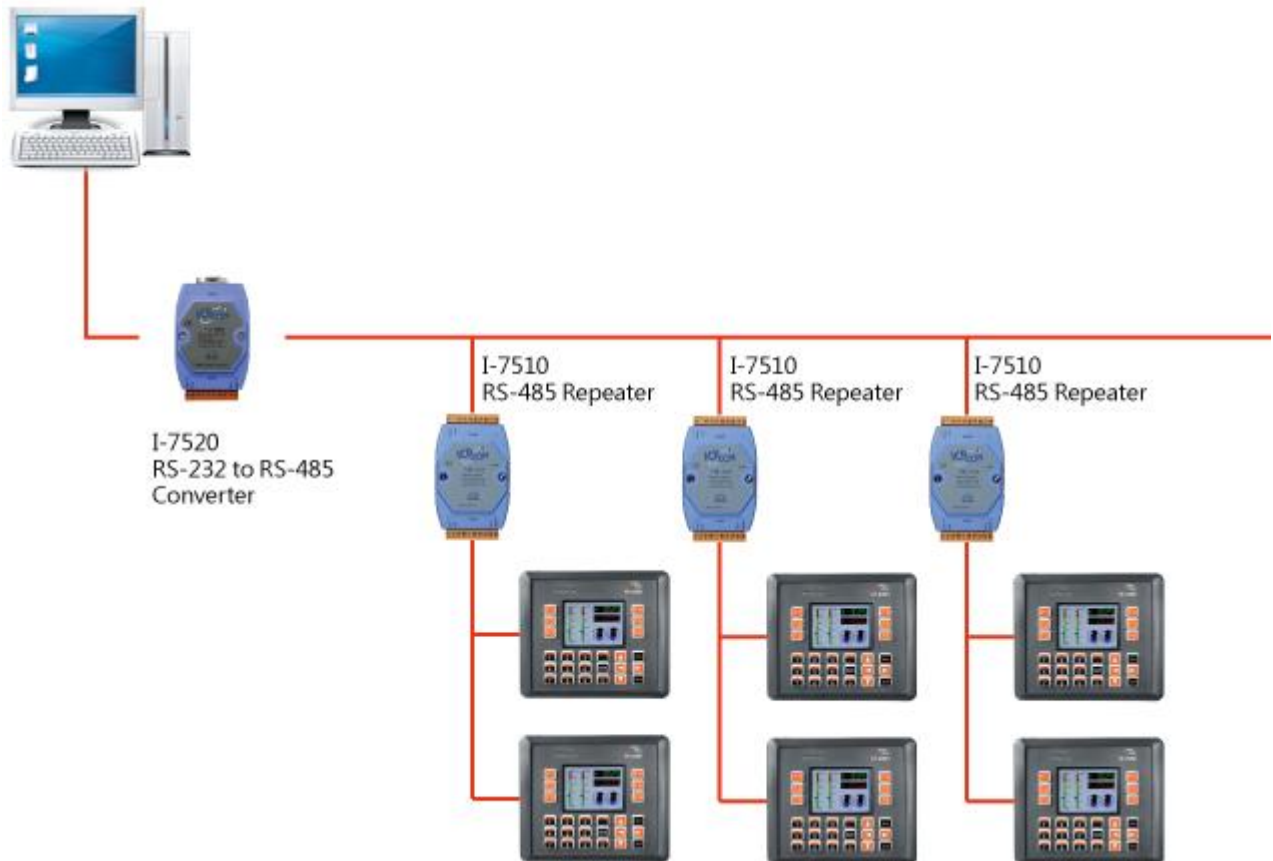

There is a better choice to use 7513 as a RS-485 hub on start type network.

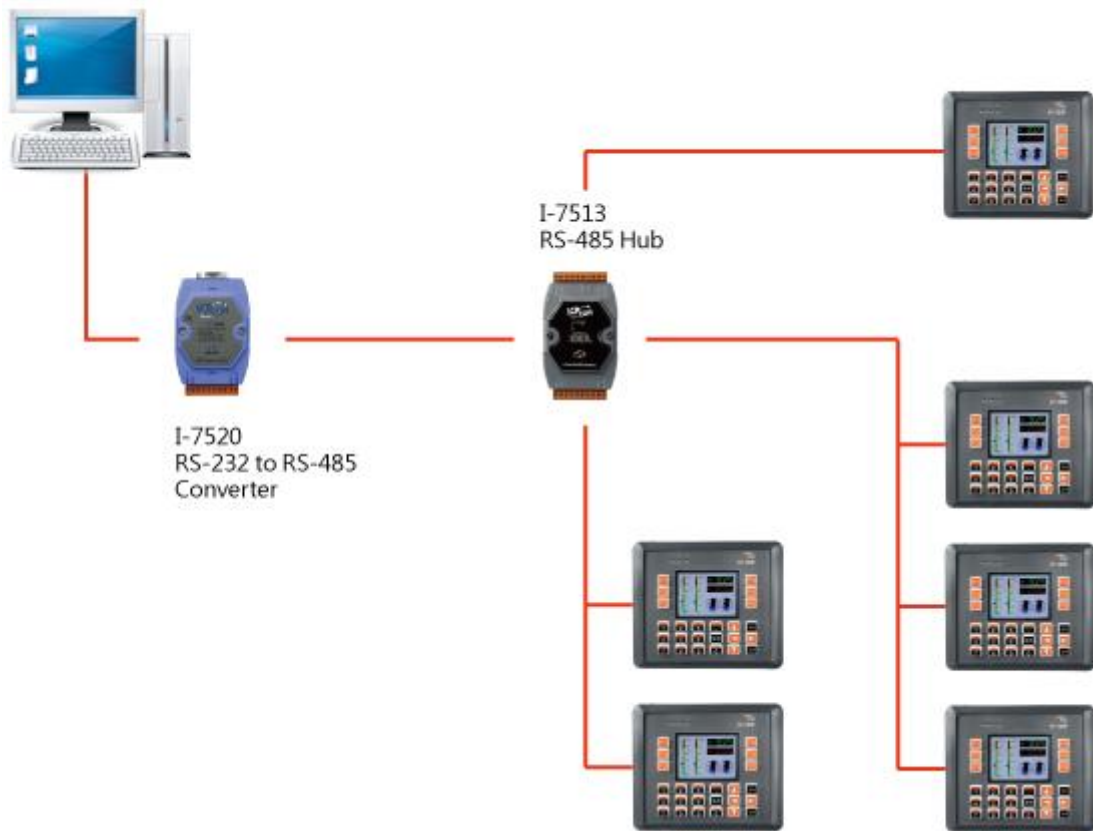

B.4. Random RS-485 Network

There are branches along the main wire. In this case, it is better to have a repeater to isolate or filter the noise that is made by devices.

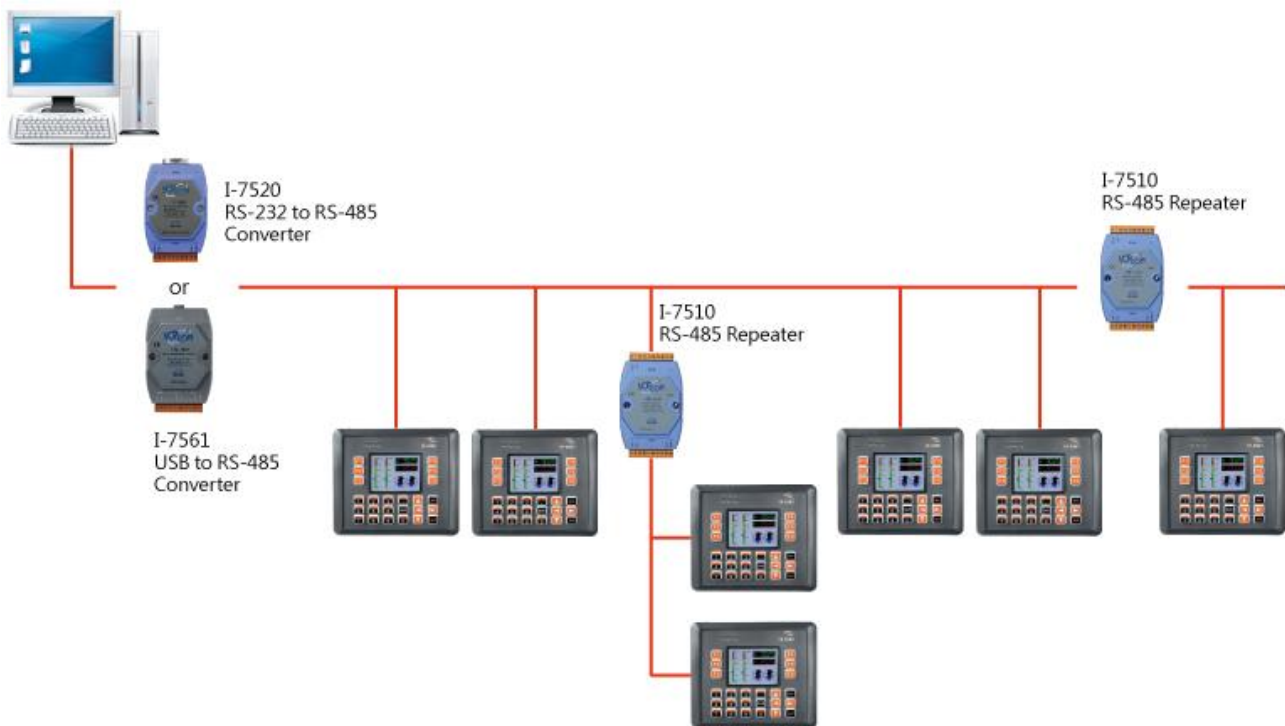

B.5. Master/Slaves Settings

There must be exist one master to have a jumper in the same network. In a master/slave application, “Master” is the default configuration of ViewPAC.

B.5.1. ViewPAC as a Master (default)

When one of ViewPAC is set to the master mode, then all the other devices on the same network must be set to the slave mode.

Set ViewPAC to the master mode by adjusting the jumpers on the power board of ViewPAC. Refer to the following figure:

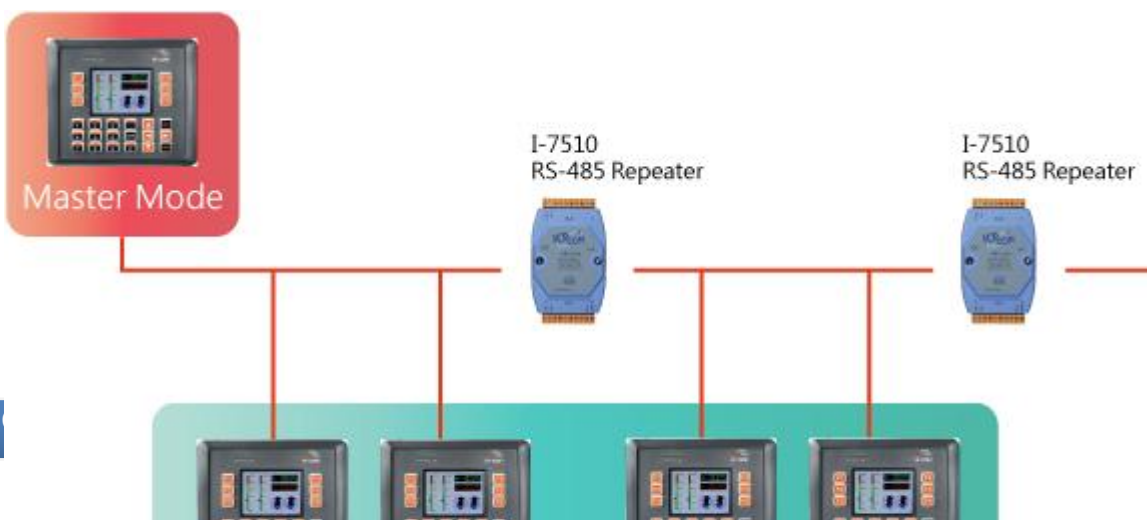
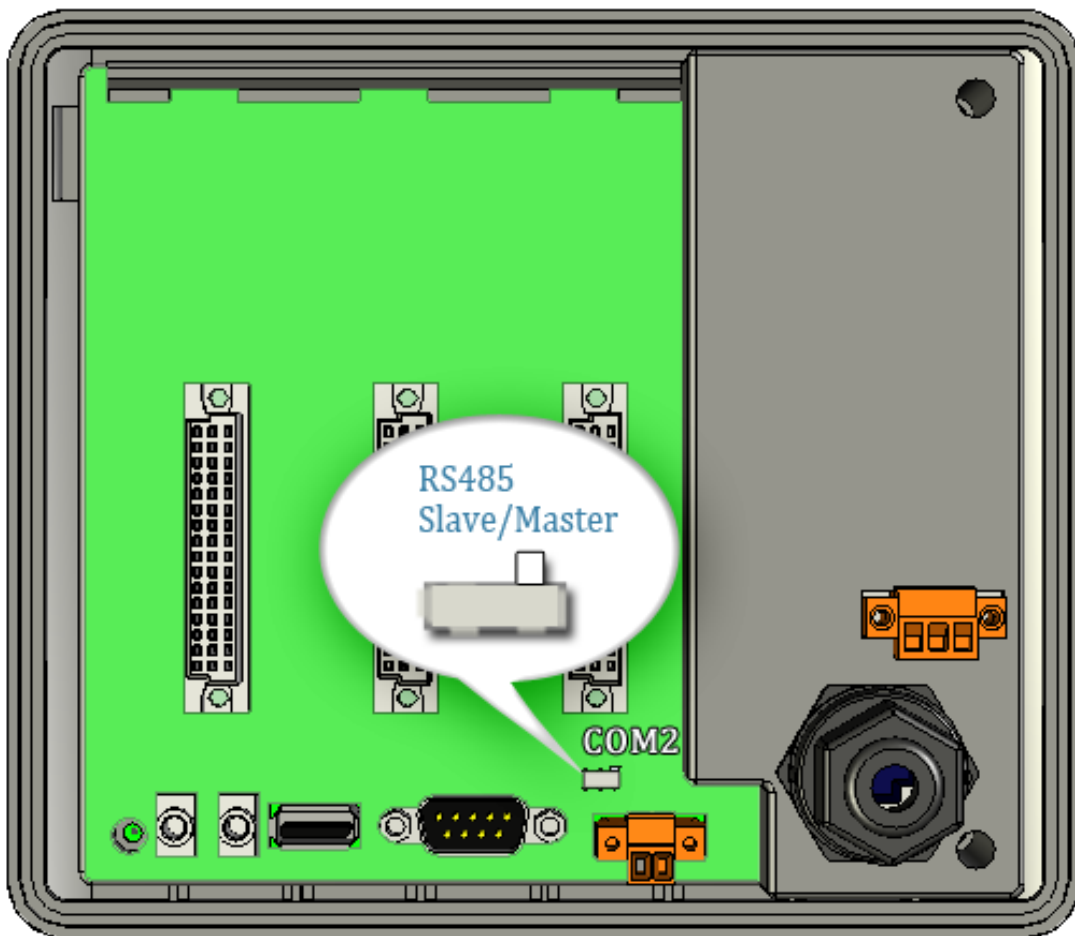

B.5.2. ViewPAC as a Slave:

Set ViewPAC to the slave mode by adjusting the jumpers on the power board of ViewPAC. Refer to the following figure:

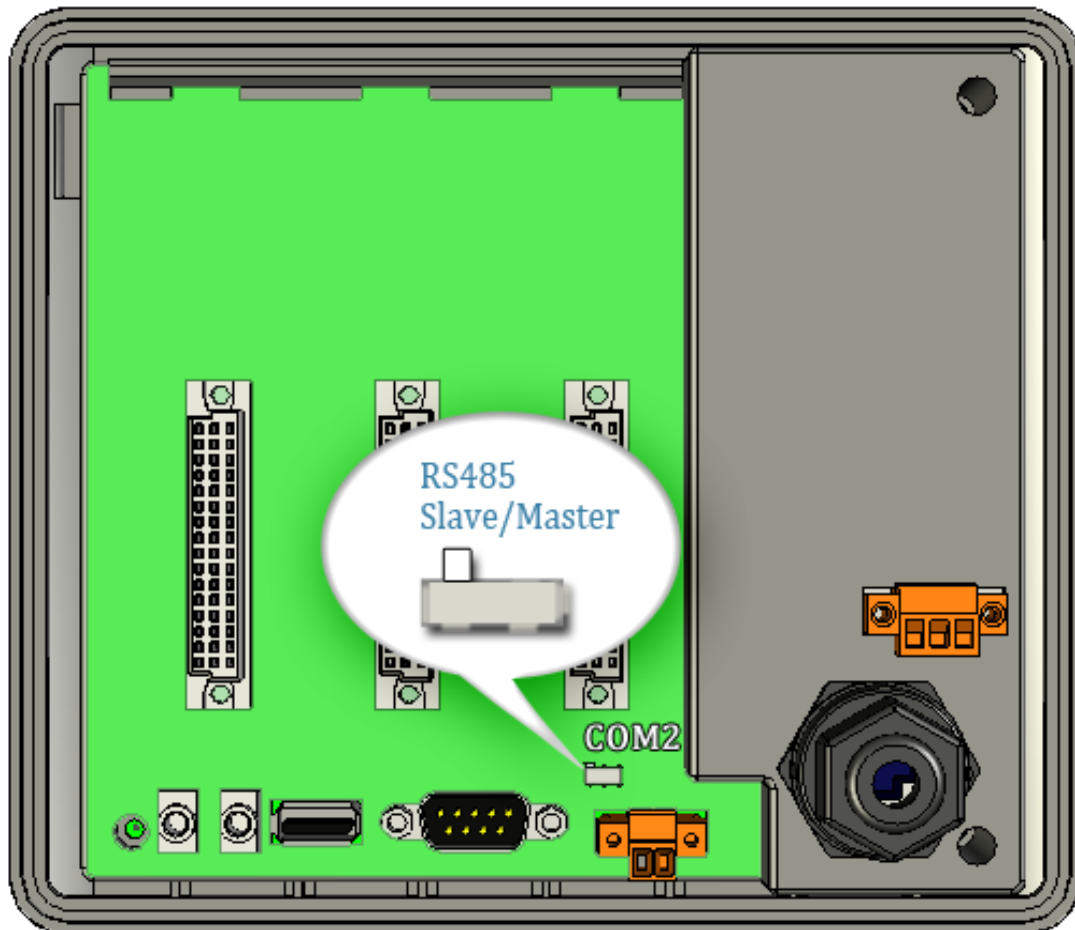

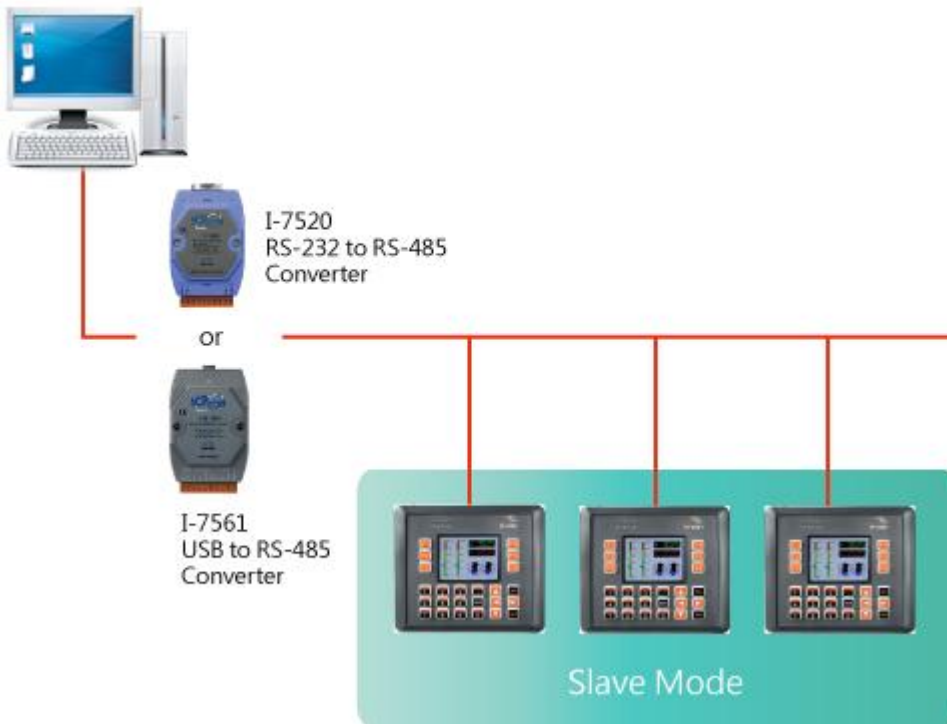

The maximum distance of RS-485 without using a repeater is 1,200 meters (4,000 feet). You can extend that distance by adding an RS-485 Repeater every 1,200 meters as shown below.

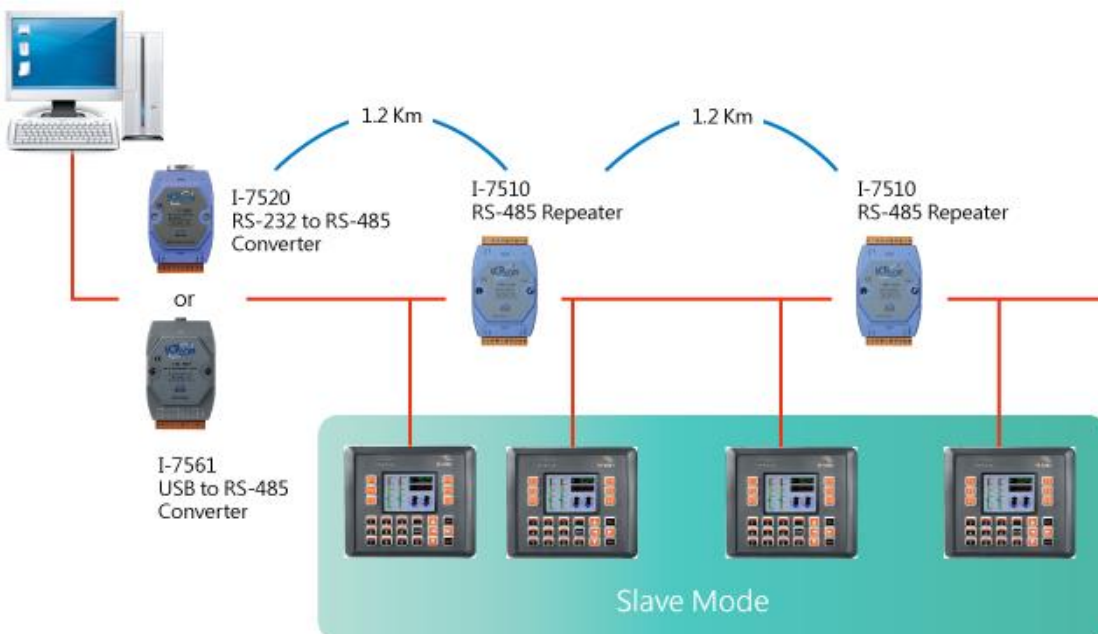

Appendix C. Tips – How to

C.1. How to add a user account to remote login the ViewPAC from PC

C.2.1. How to add a user account

Here are step by step instructions on how to add a user account.

Step 1: Run the ViewPAC Utility

Step 2: On the Network tab, click Login tab, type the User Name and Password, and then click Add button

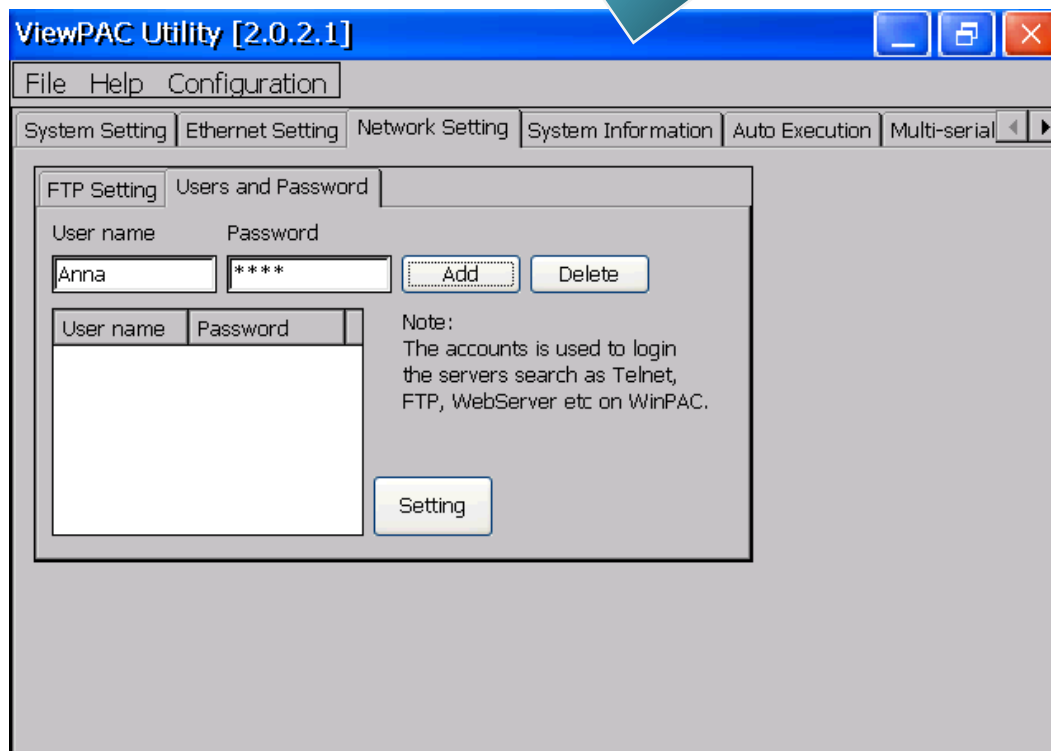

Step 3: The user has been added to the allowed under the remote login and included in the following list

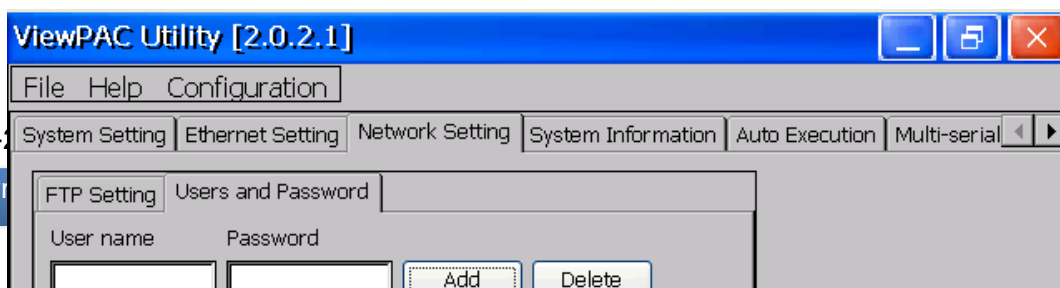

Step 4: On the File menu, click Save and Reboot for changes to take effect

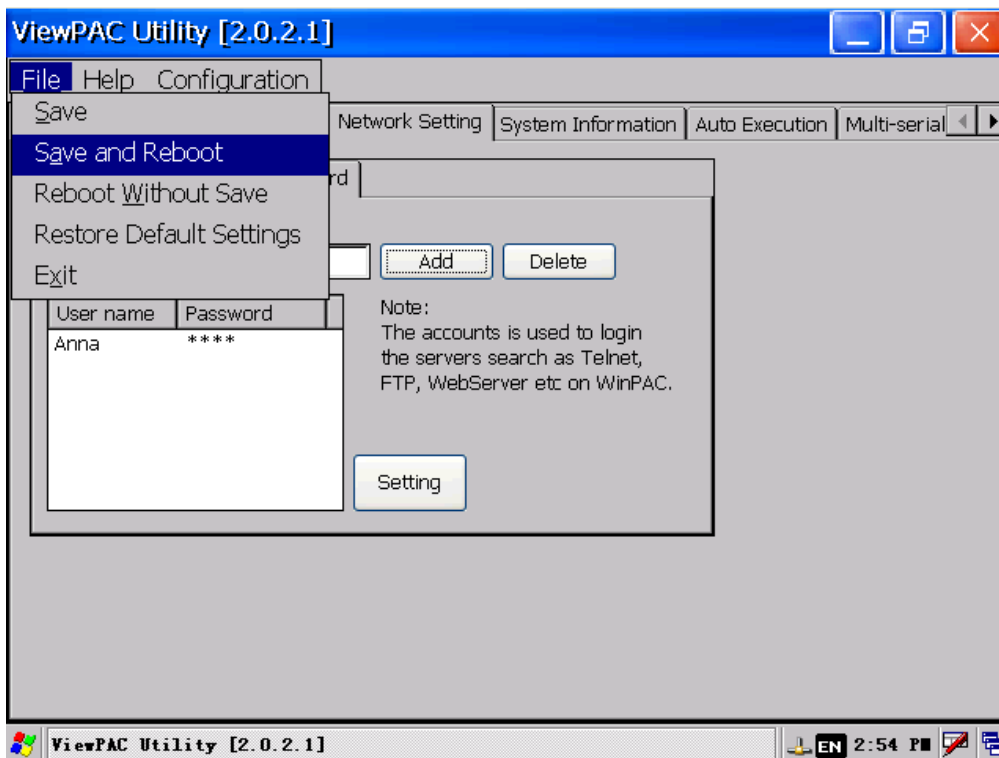

C.2.2. How to Use telnet to remote login the ViewPAC from PC

Here are step by step instructions on how to use telnet to remote login the XPAC from PC.

Step 1: On the PC, open a MS-DOS command prompt

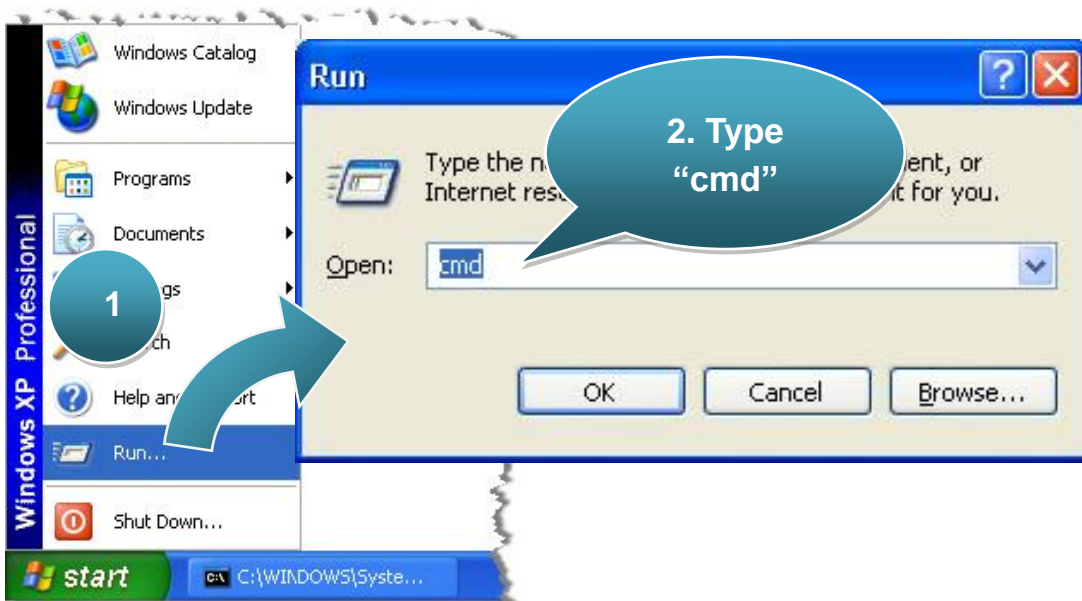

Step 2: At the command prompt, type "telnet (IP address)"

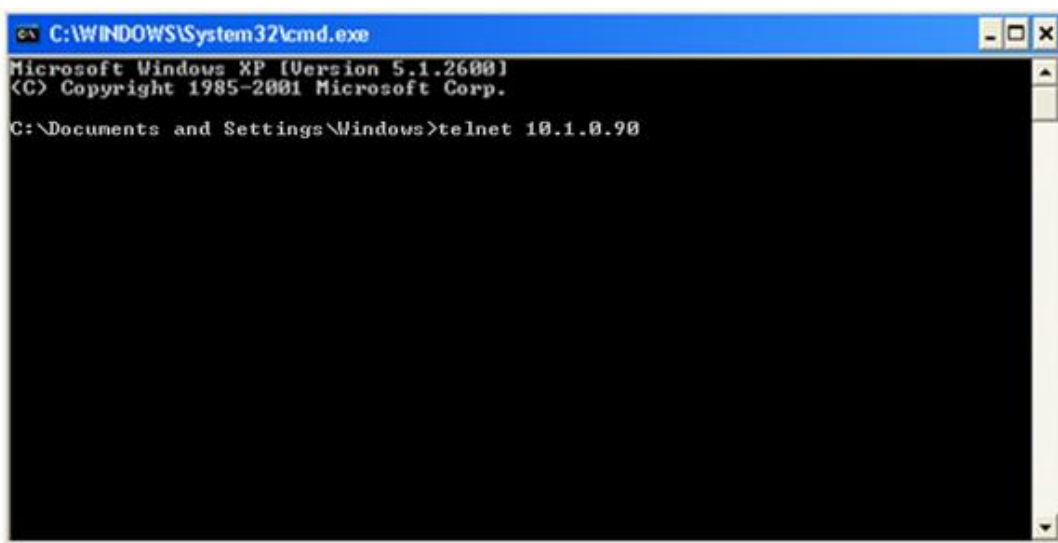

Step 3: The connection has been set up, and then type the name and password

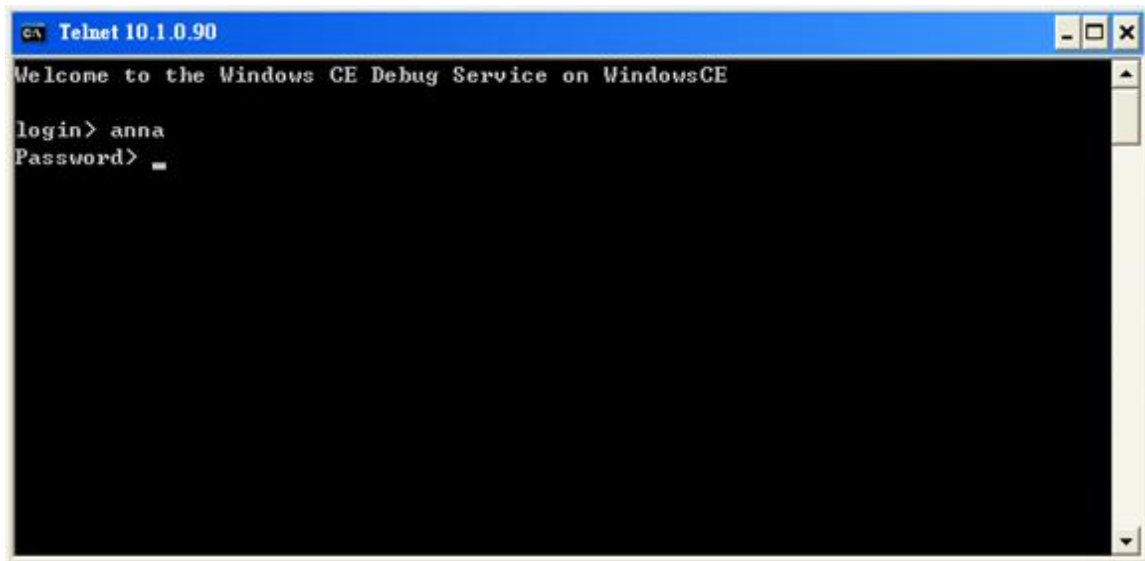

```
c:\> Telnet 10.1.0.90
Welcome to the Windows CE Debug Service on WindowsCE

login> anna
Password> _
```

Step 4: The remote login has been completed

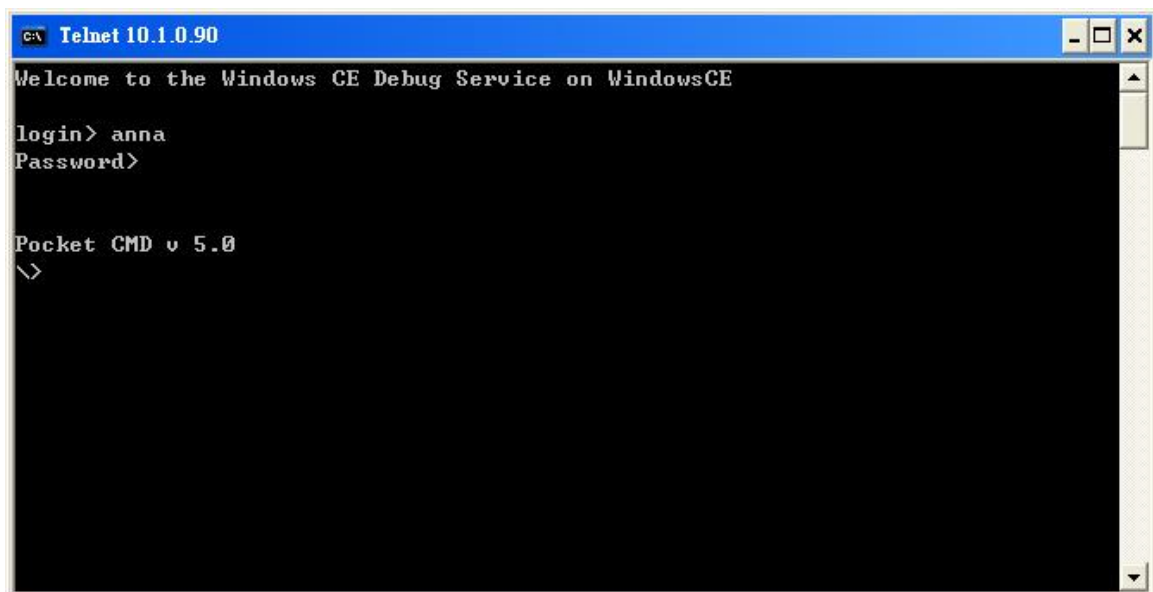

```
c:\> Telnet 10.1.0.90
Welcome to the Windows CE Debug Service on WindowsCE

login> anna
Password>

Pocket CMD v 5.0
\>
```

C.2.3. How to remove the user from the login list

Here are step by step instructions on how to remote the user from the login list.

Step 1: Click a user from the list which you want to remove, and the user will display in the field, and then press Delete to delete the user from the login list

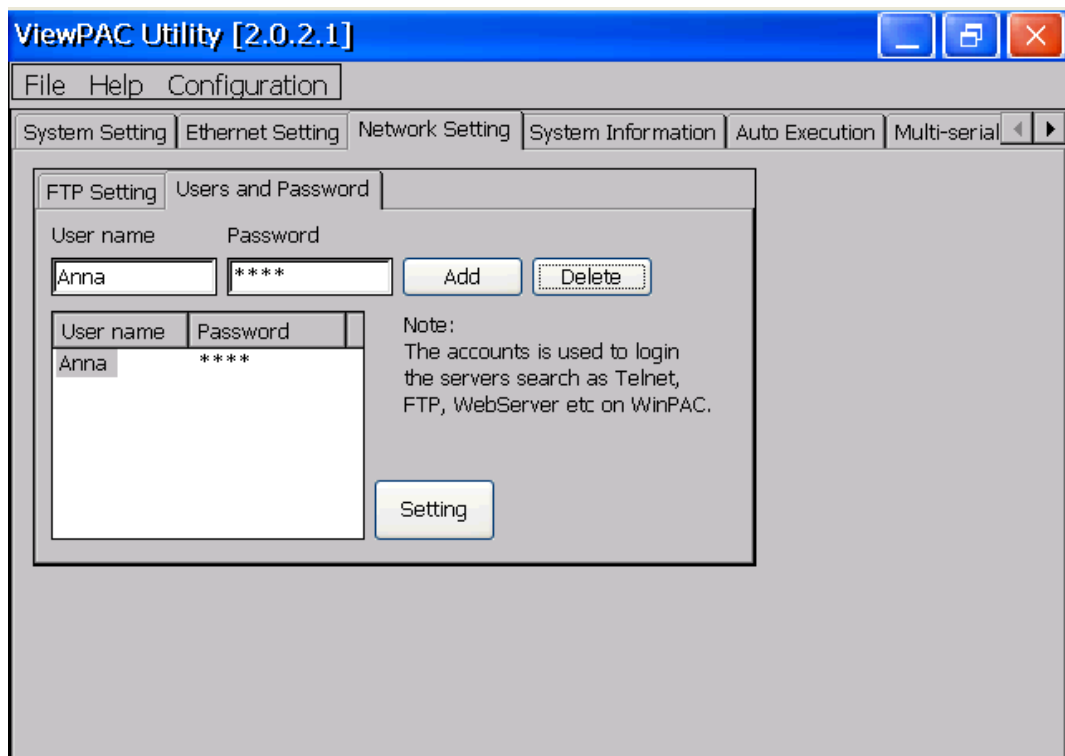

Step 2: On the File menu, click Save and Reboot for changes to take effect

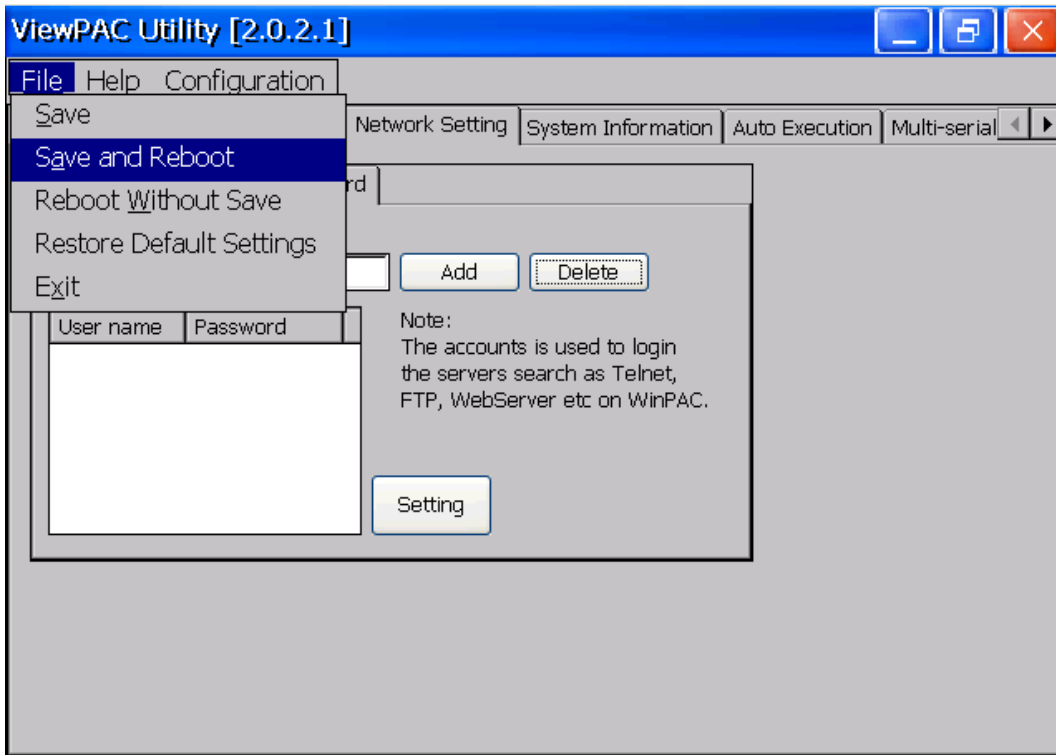

C.2. How to online debug ViewPAC

Debugging is a process that you use to find and resolve errors, or bugs, in a program.

C.2.1. Debug ViewPAC programs in EVC++

Step 1: On the “Tools” menu, click “Configure Platform Manager...” command

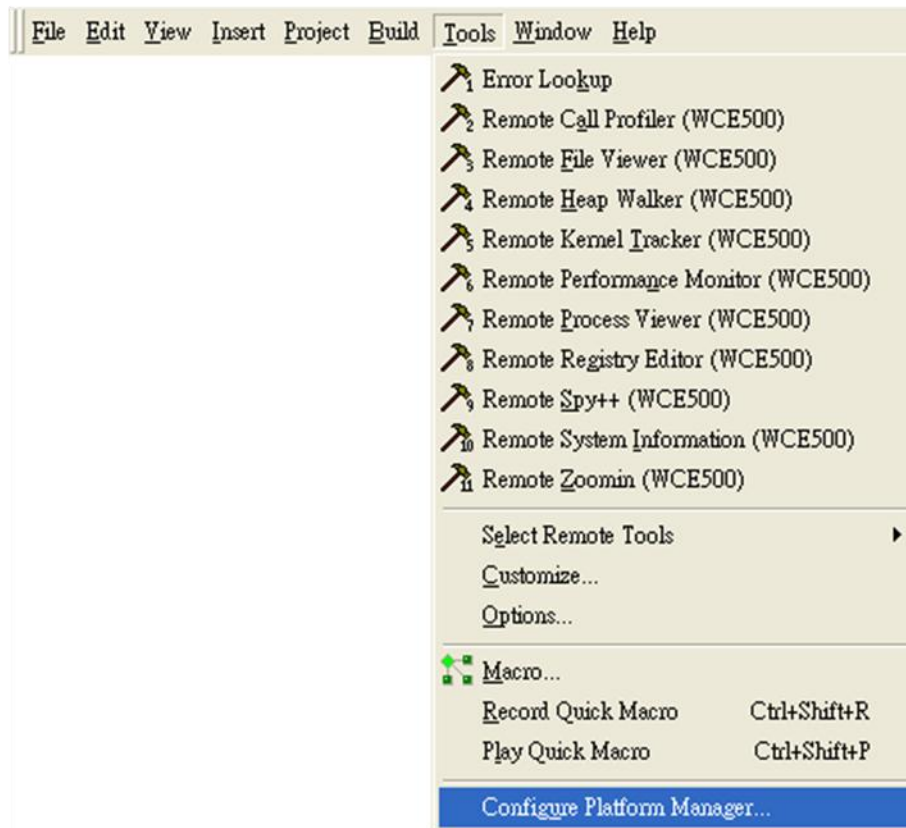

Step 2: On the “Windows CE Platform Manager Configuration” dialog, click the “Properties...” button

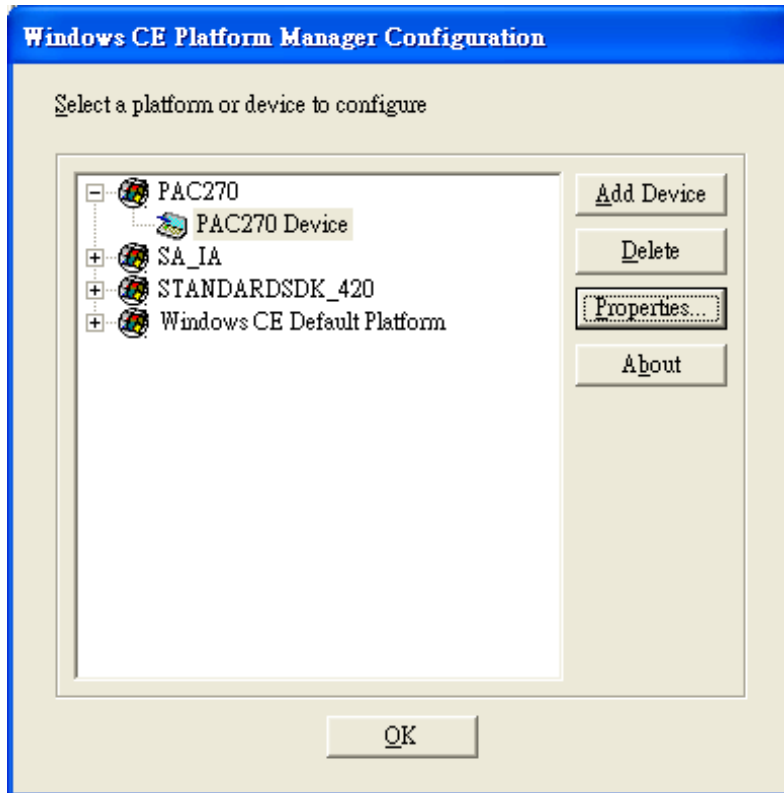

Step 3: On the “Device Properties” dialog, click the “Configure...” button

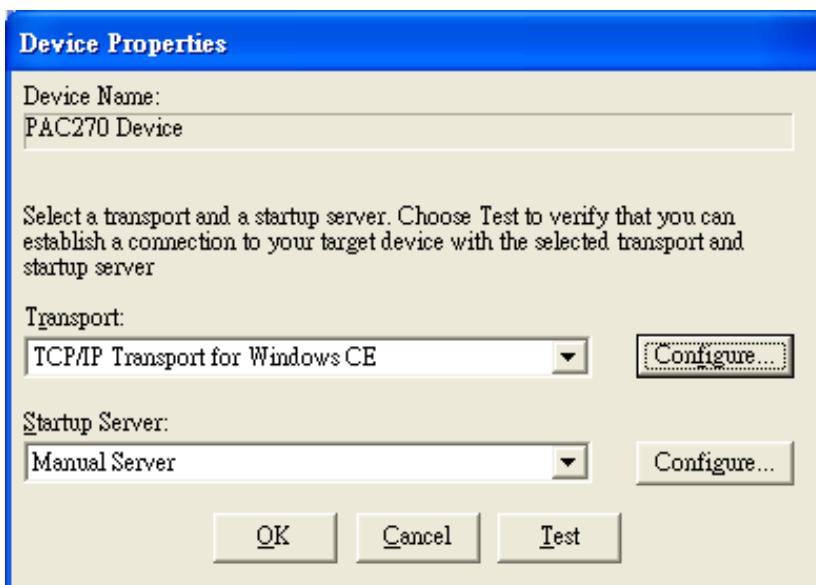

Step 4: On the “TCP/IP Transport Configuration” dialog, select the “Fixed port” check box, and then click the “OK” button

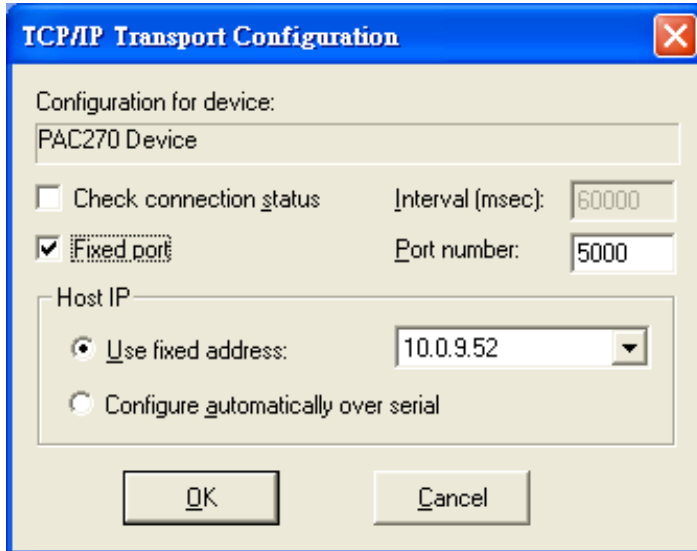

Step 5: On the “Windows CE Platform Manager Configuration” dialog, click the “Test” button

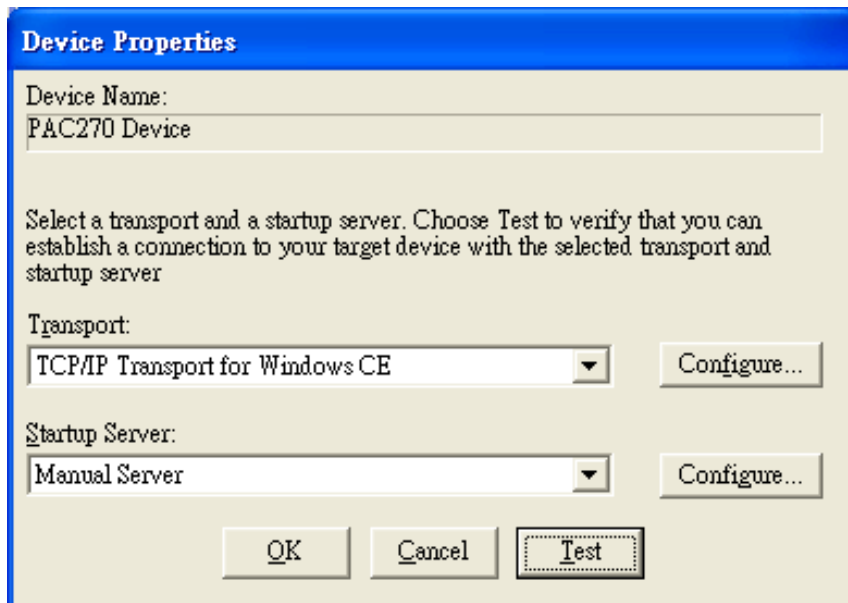

Step 6: The “Manual Server - Action” dialog will appear displaying a command line, before click the “OK” button to close dialog, turn to the ViewPAC controller side to do the next two-steps

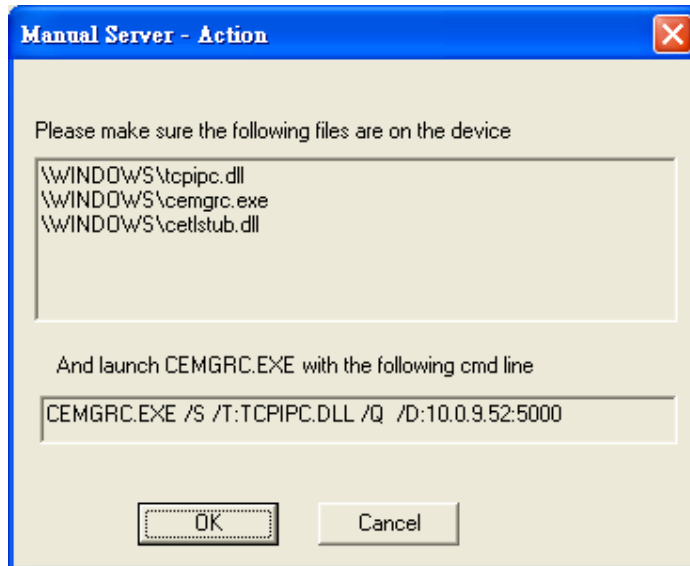

Step 7: On the ViewPAC controller side, select  the “ Start” menu, and then click the “Run...” command

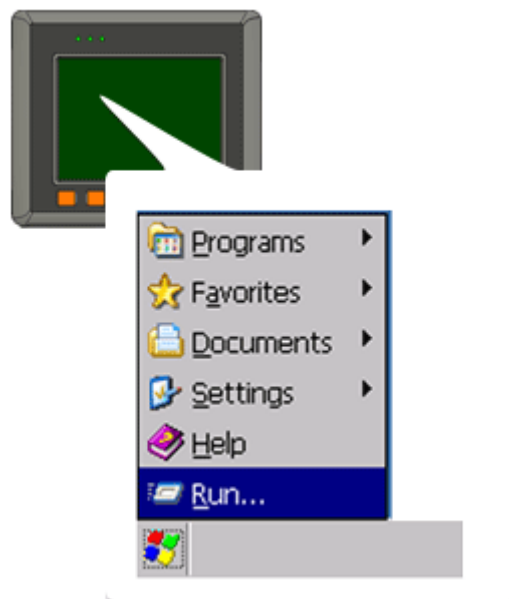

Step 8: On the “Run” dialog, type the command which displays in step 5 and then click the “OK” button

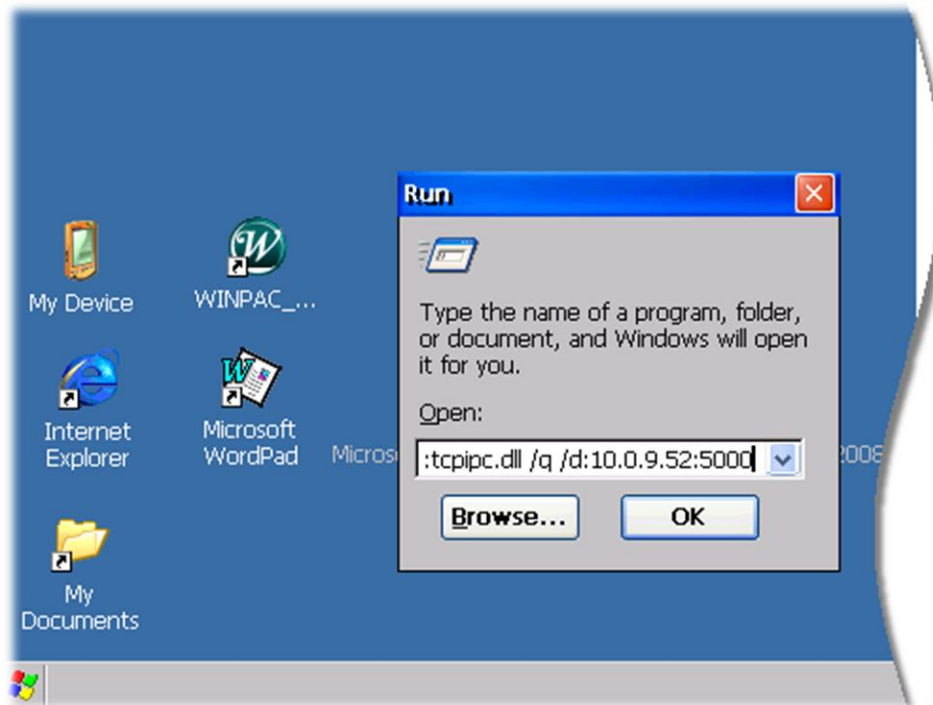

Step 9: Return to the Host PC side, on the “Manual Server – Action” dialog, click the “OK” button

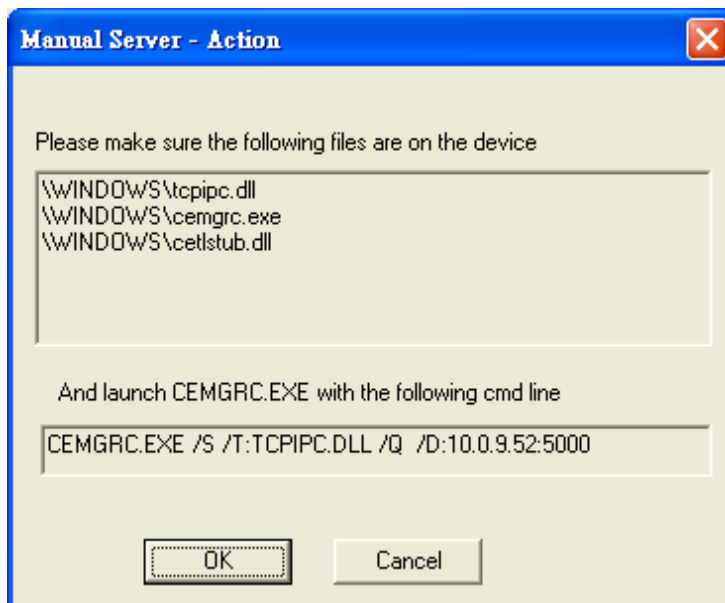

Step 10: On the “Testing Device Connection” dialog, click the “OK” button



Step 11: On the “Device Properties” dialog, click the “OK” button

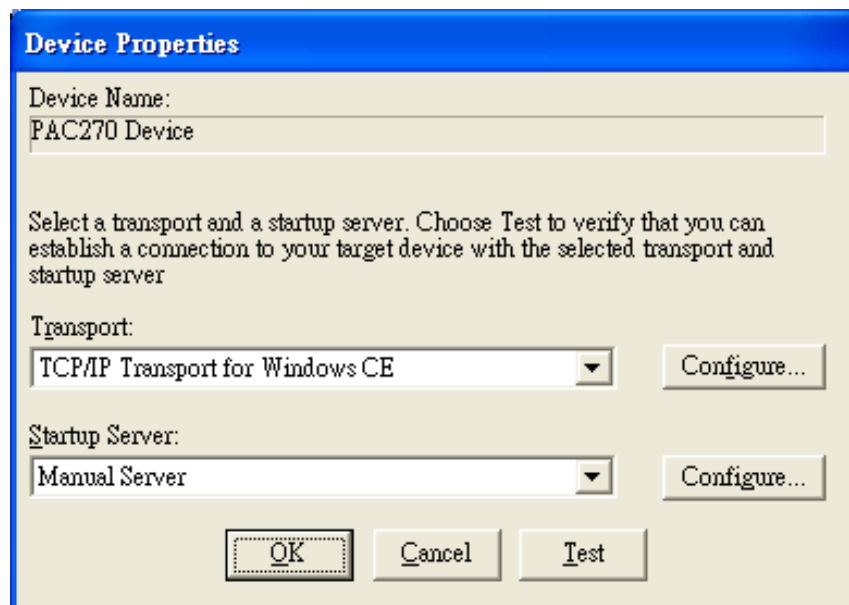

Step 12: On the “Windows CE platform or device to configure” dialog, click the “OK” button

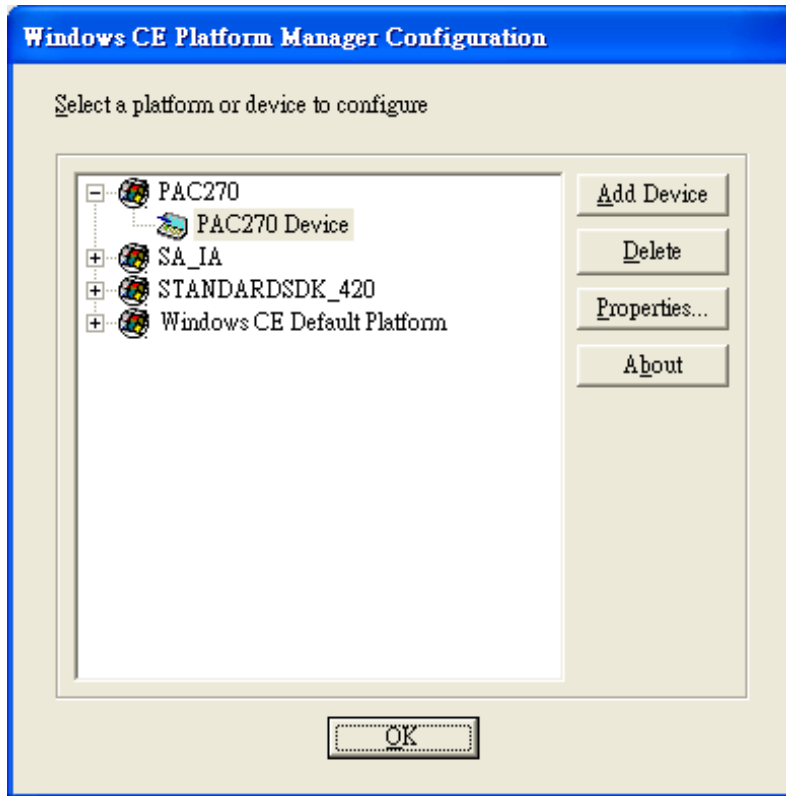

Step 13: On the “Build” menu, select the “Start Debug” command and then click the “Go” command

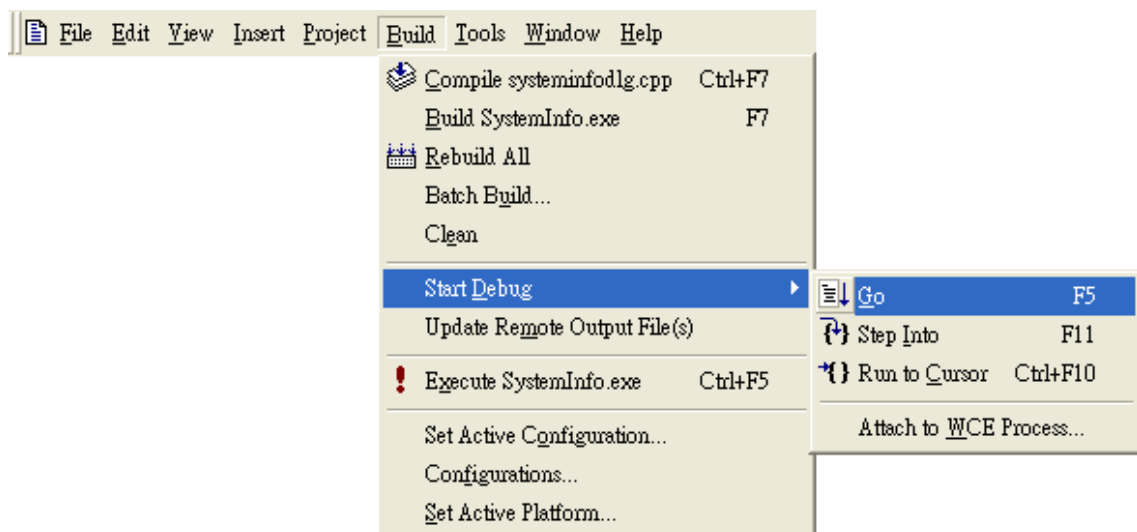

Step 14: The “Manual Server - Action” dialog will appear displaying a command line, before click the “OK” button to close dialog, turn to the ViewPAC controller side to do the next two-steps

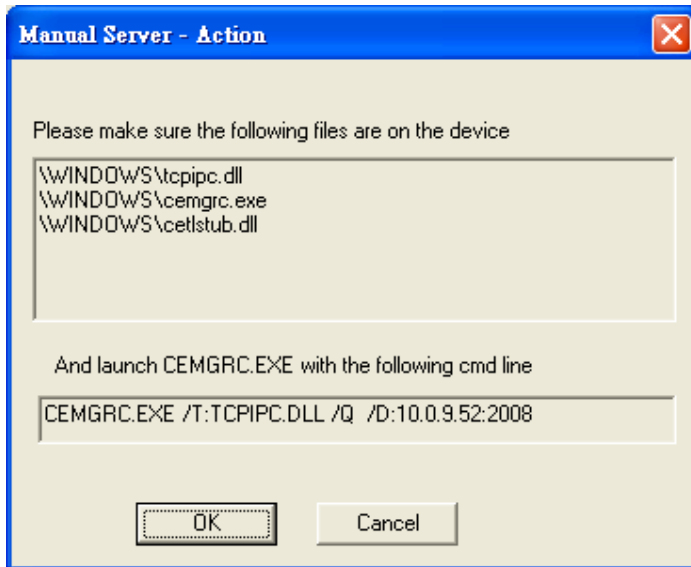

Step 15: On the ViewPAC controller side, select the “ Start” menu, and then click the “Run...” command

 “ Start” menu,

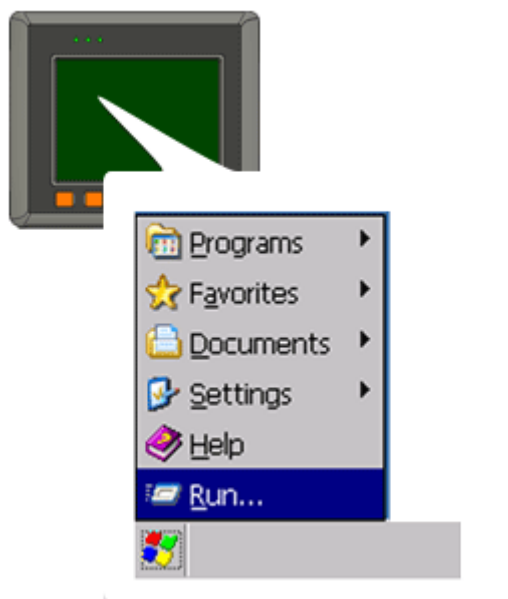

Step 16: On the “Run” dialog, type the command which displays in step 5 and then click the “OK” button

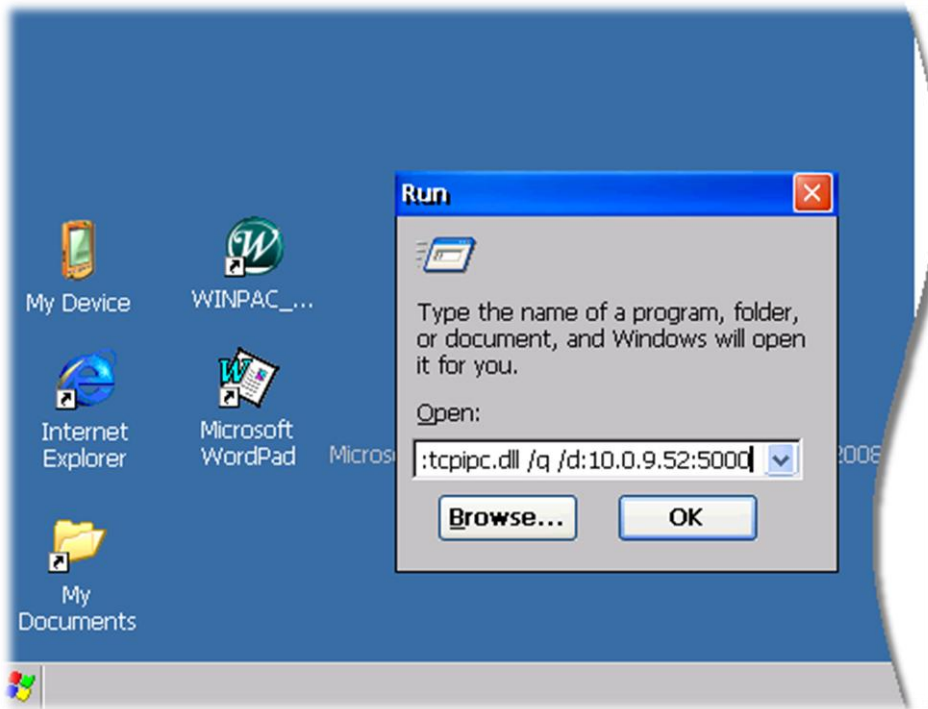

Step 17: Return to the Host PC side, on the “Manual Server – Action” dialog, click the “OK” button

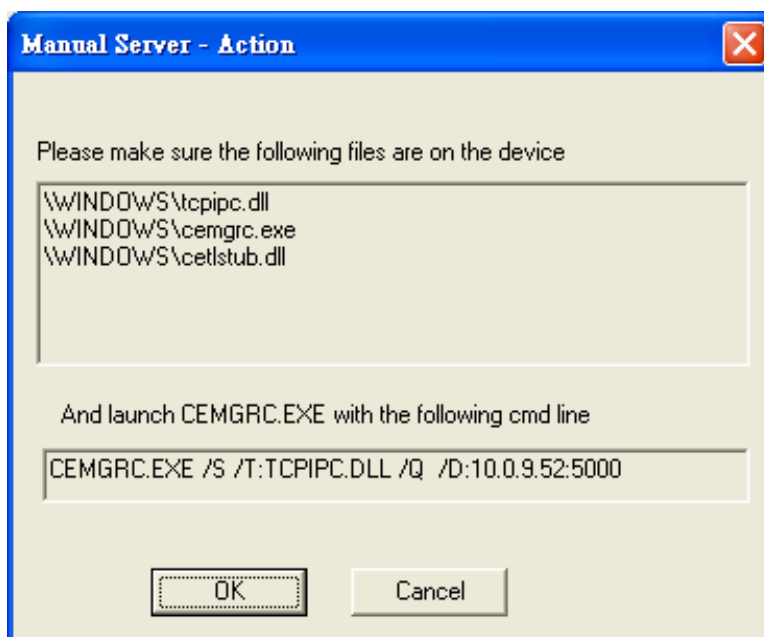

Step 18: On the “Manual Server - Action” dialog, click the “OK” button

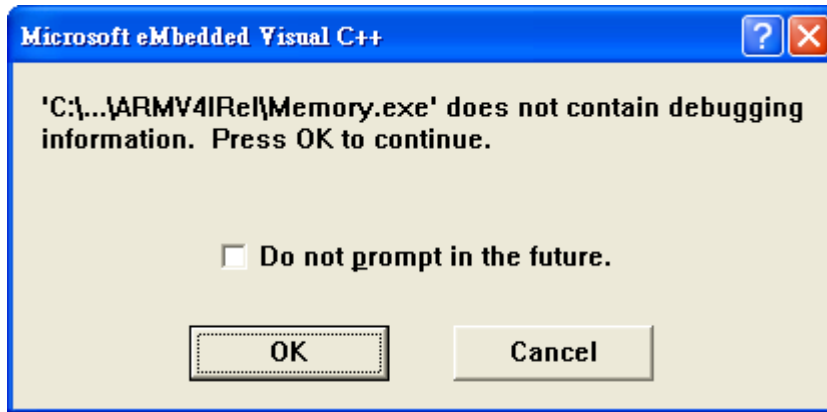

Step 19: Connection established. Then you can debug on line.

Tips & Warnings



If you want to quit the debugger and return to editing, you can click the “Stop Debugging” button from “Debug” menu

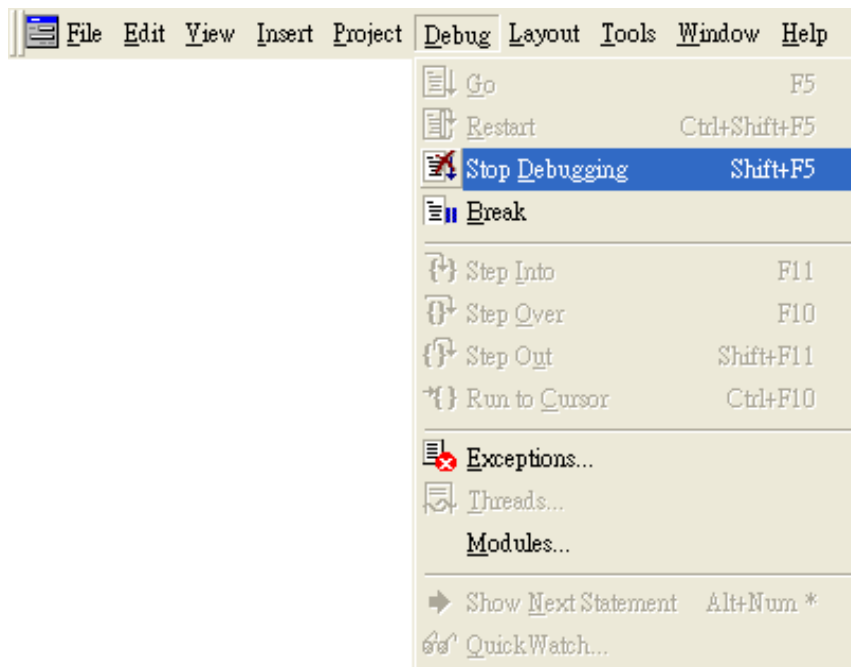

C.2.2. Debug ViewPAC programs in Visual Studio 2005/2008

Debugging in Visual Studio 2005/2008 are provided by ViewPAC OS image V 1.3.0.4 or later.

Step 1: Make sure the following file are listed with the matching version numbers

Path	File
C:\Program Files\Common Files\Microsoft Shared\CoreCon\1.0\Bin	1. ActiveSyncBootstrap.dll 2. ConMan2.dll 3. ConManPS.dll 4. DesktopDMA.dll 5. eDbgTL.dll 6. TcpConnectionC.dll
C:\Program Files\Common Files\Microsoft Shared\CoreCon\1.0\Bin\1033	conmanui.dll
C:\Program Files\Common Files\Microsoft Shared\CoreCon\1.0\Target\wce400\armv4i	1. DeviceDMA.dll 2. eDbgTL.dll 3. TcpConnectionA.dll 4. clientshutdown.exe 5. CMAccept.exe 6. ConmanClient2.exe

Step 2: If the version matches correctly and the entire file are there, copy the following files to ViewPAC :\ System_Disk\ICPDAS\System folder

- ✓ Clientshutdown.exe
- ✓ ConmanClient2.exe
- ✓ CMAccept.exe
- ✓ eDbgTL.dll
- ✓ TcpConnectionA.dll

Step 3: On the “Project” menu, click “[Project Name] Properties...” command

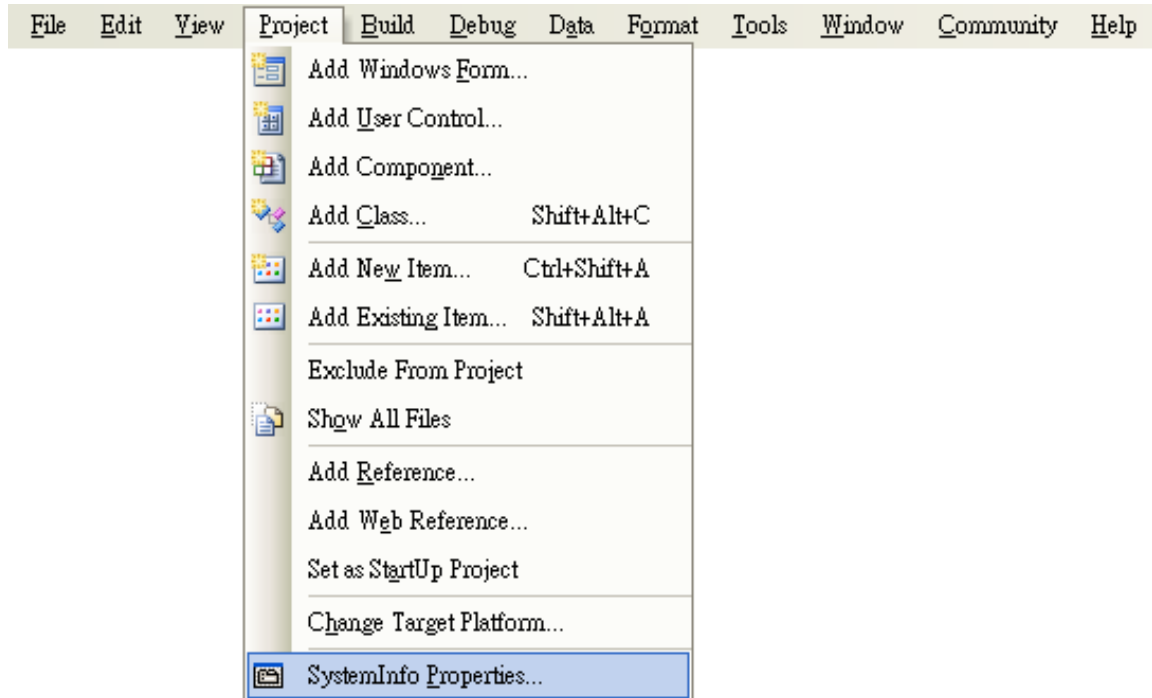

Step 4: On the “SystemInfo*” tab, unselect “Deploy the latest version of the .NET compact Framework (including Service Packs)” check box

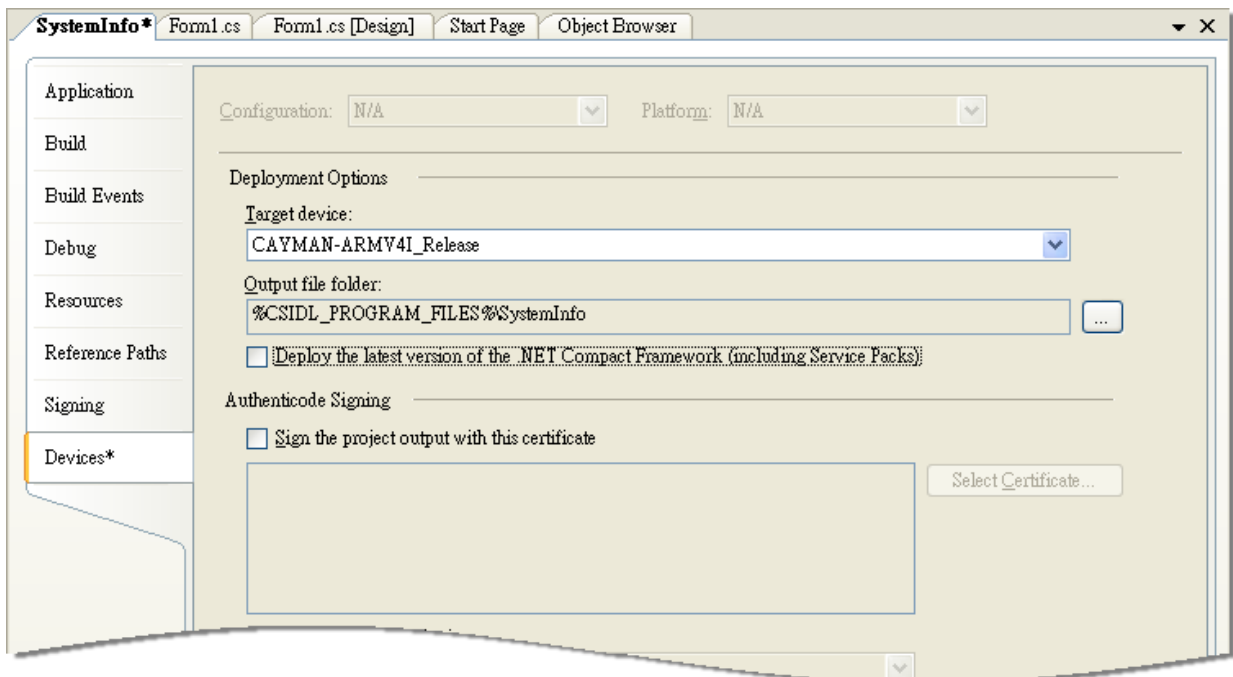

Step 5: On the “Tools” menu, click “Options...” command

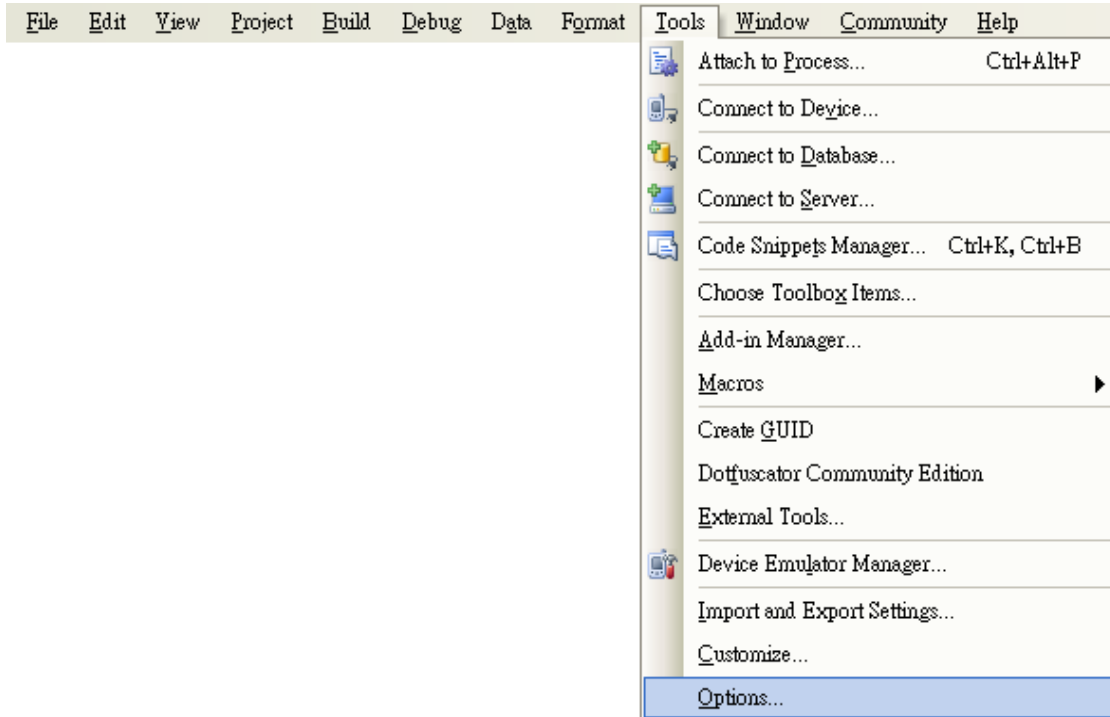

Step 6: On the “Options” dialog, select “PAC 270” from the “Show devices platform” list, and then click the “Properties...” button

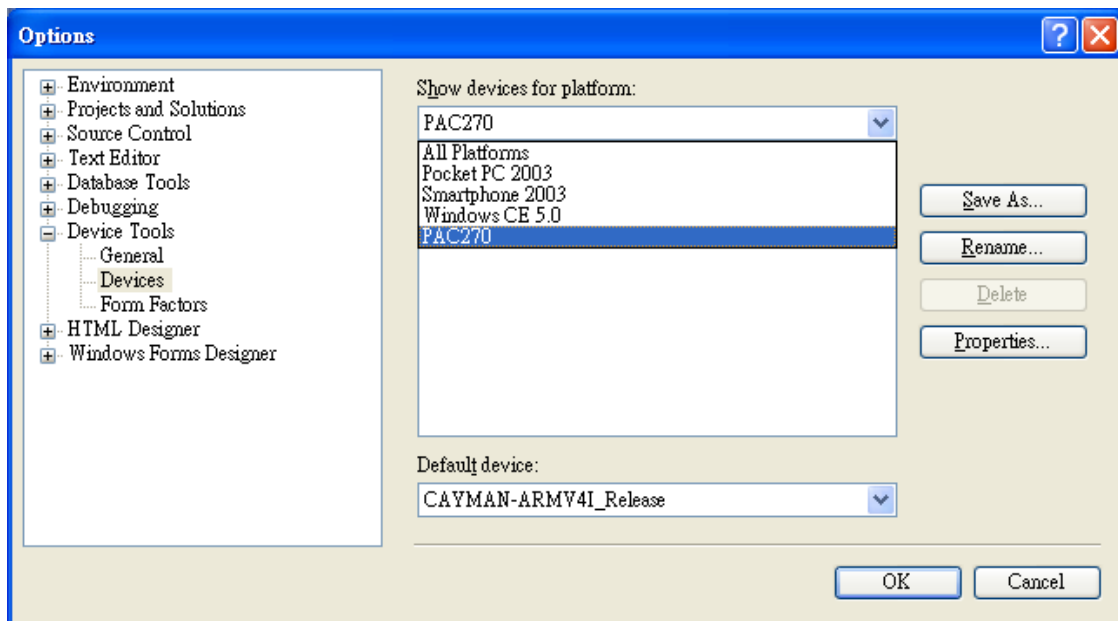

Step 7: On the “CAYMAN-ARMV4I_Release Properties” dialog, click the “Configure...” button

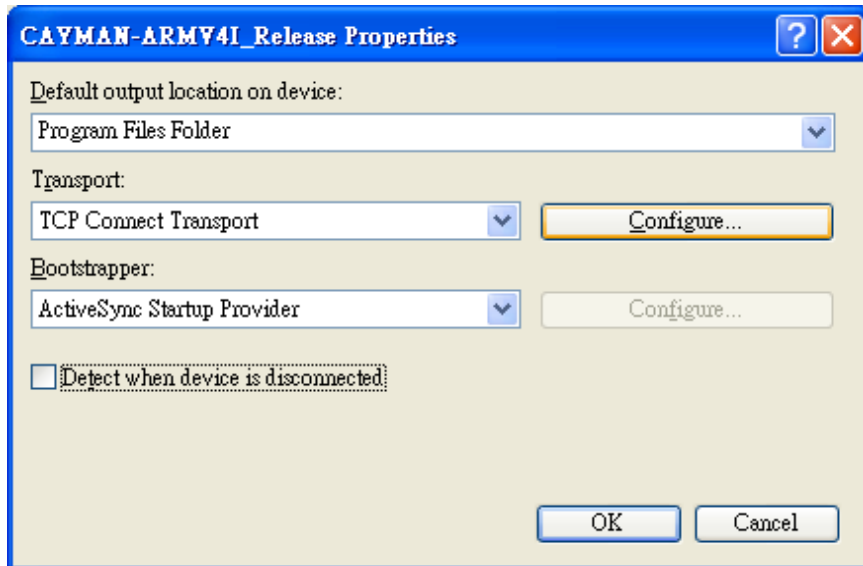

Step 8: On the “Configure TCP/IP Transport” dialog, select the “Use specific IP address” option and type the IP address of ViewPAC, and then click the “OK” button

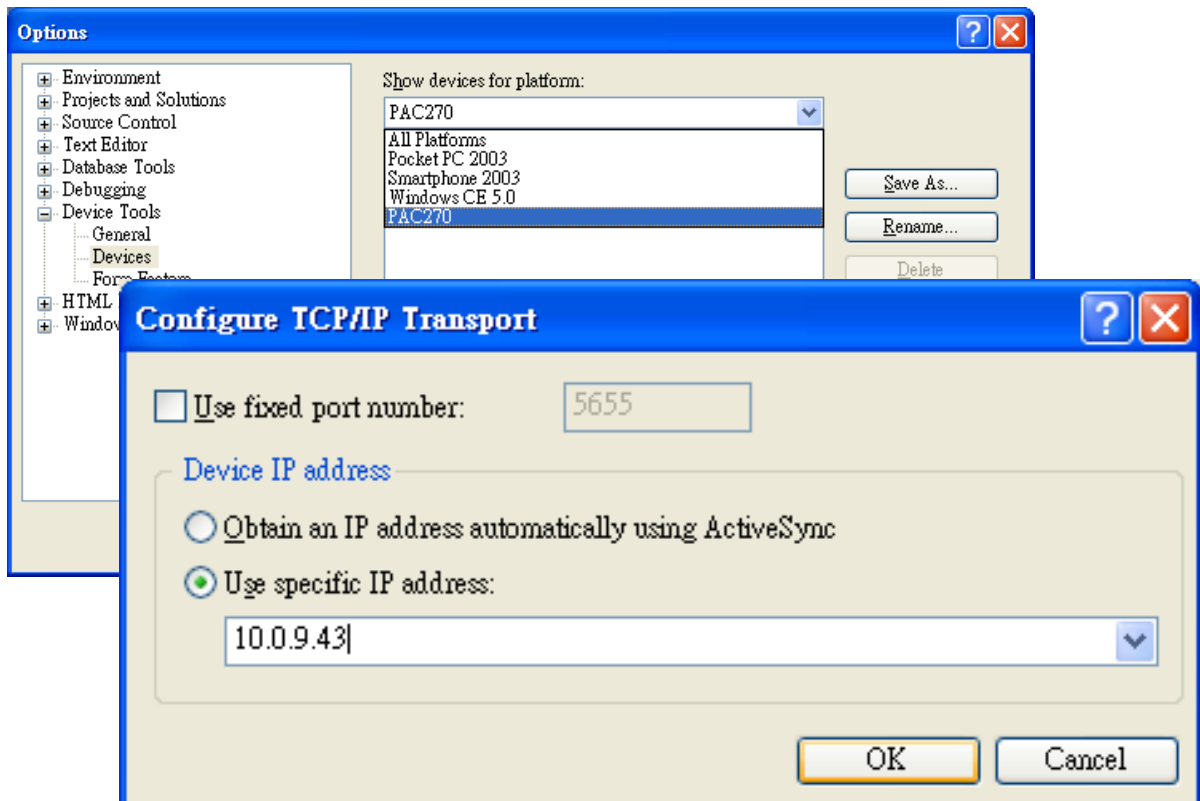

Step 9: On the “CAYMAN-ARMV4I_Release Properties” dialog, click the “OK” button

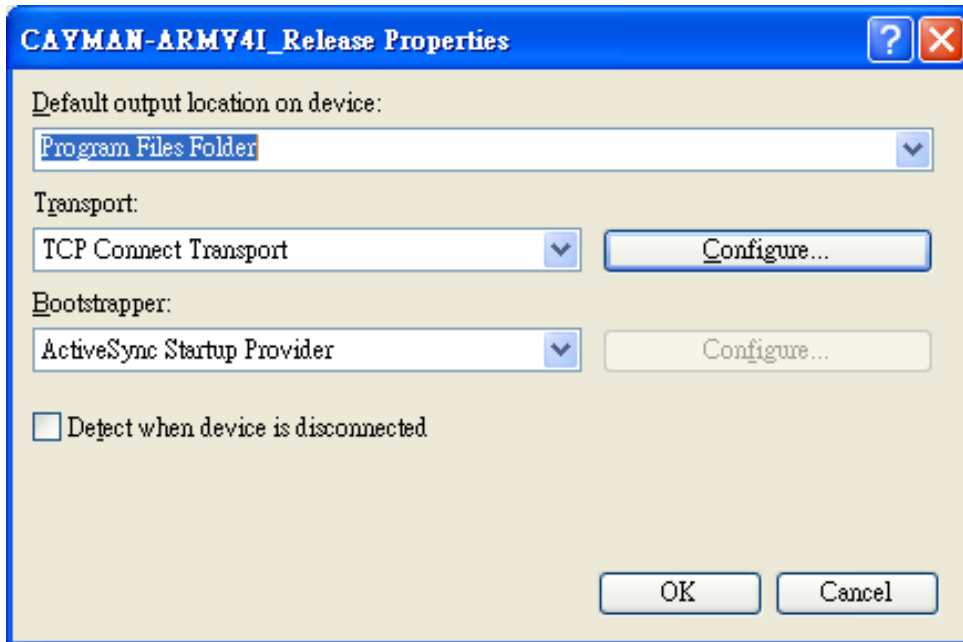

Step 10: On the “Options” dialog, click the “OK” button

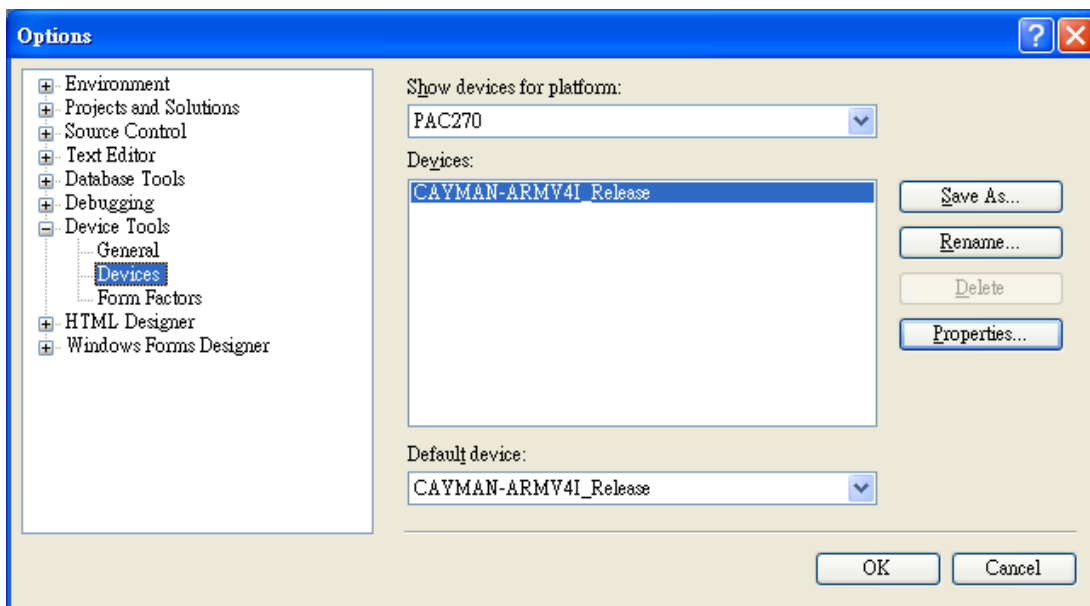

**Step 11: On the ViewPAC controller side, run the “CommanClient2” and the “CMAccept.exe” applications which is located at:
\\System_Disk\ICPDAS\System**

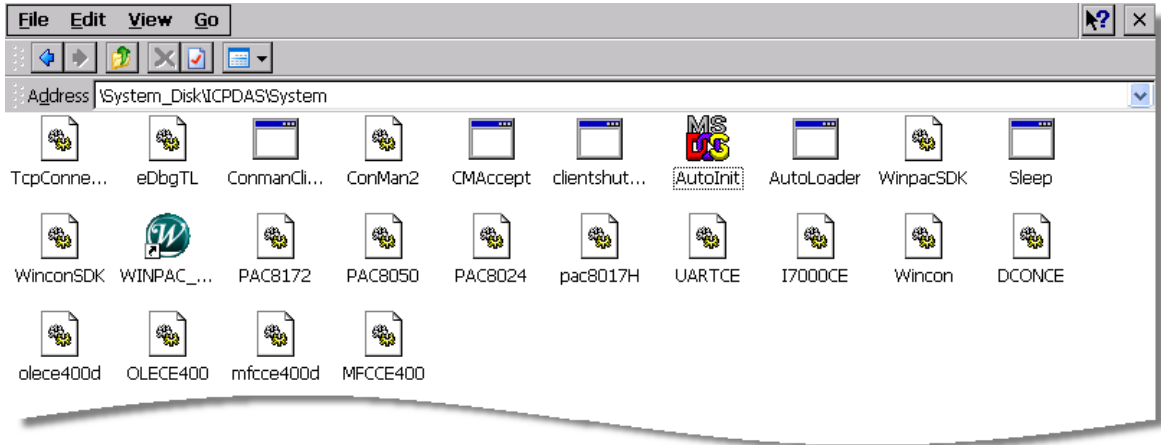

Step 12: On the “Tools” menu, click “Connect to Device...” command

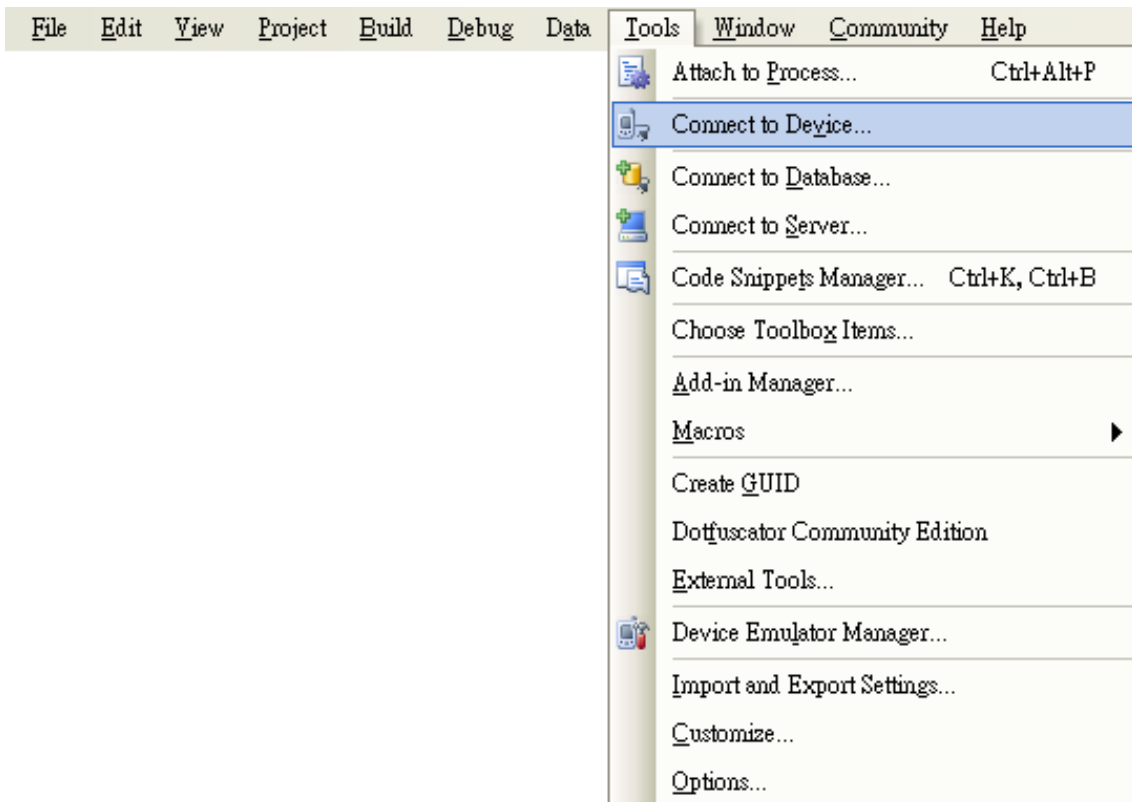

Step 13: On the “Connect to Device” dialog, select “PAC 270” from “Platform” list and then click the “Connect” button

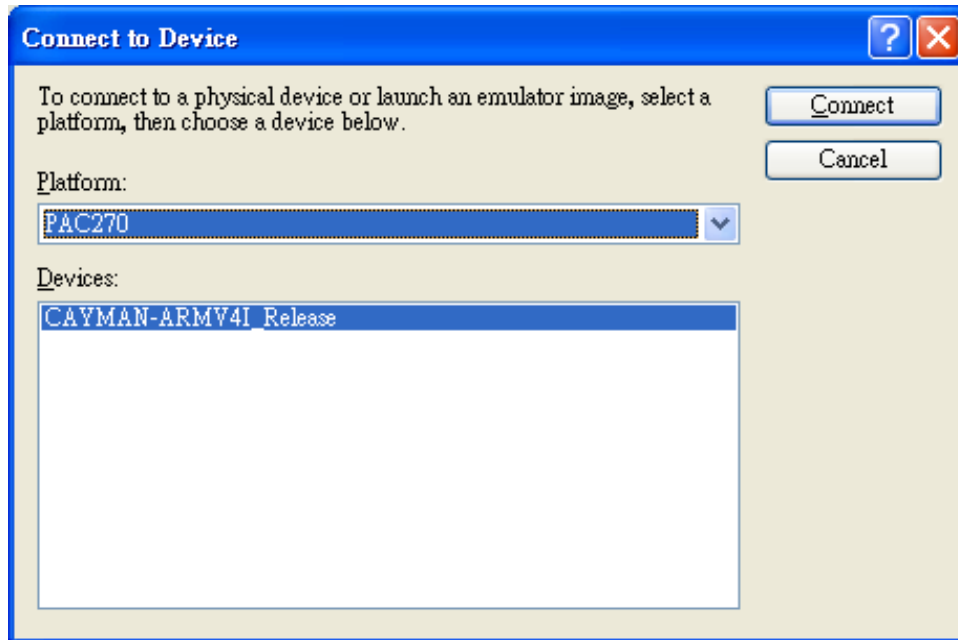

Step 14: On the “Tools” menu, click “Connect to Device...” command

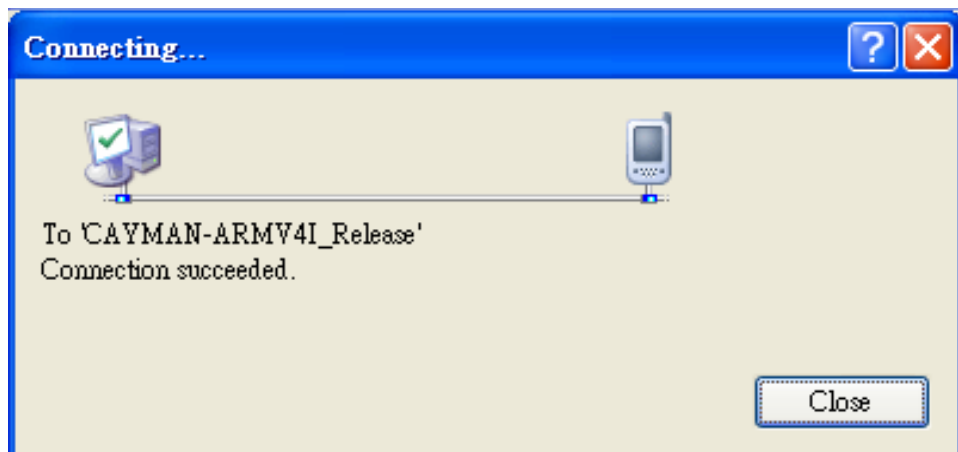

Step 15: Connection established. Then you can debug on line.

FAQ:

If the connection fails shown as follow, return to step 11 to do the action below

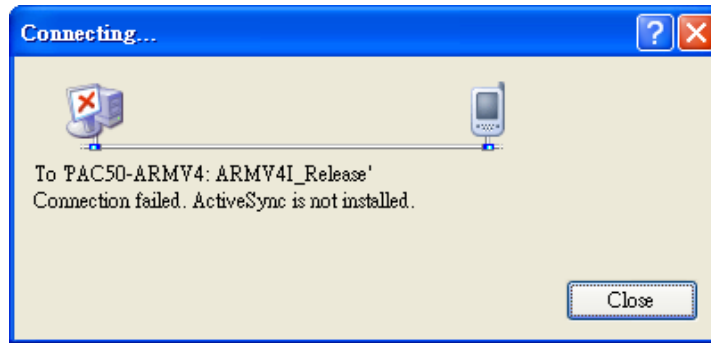

Open the command prompt, run the

“CommanClient2.exe/transport:tcpconnectiona.dll/property:port=5000/
id:Con” at: \System_Disk\ICPDAS\System, and then run the
“CMAccept.exe”

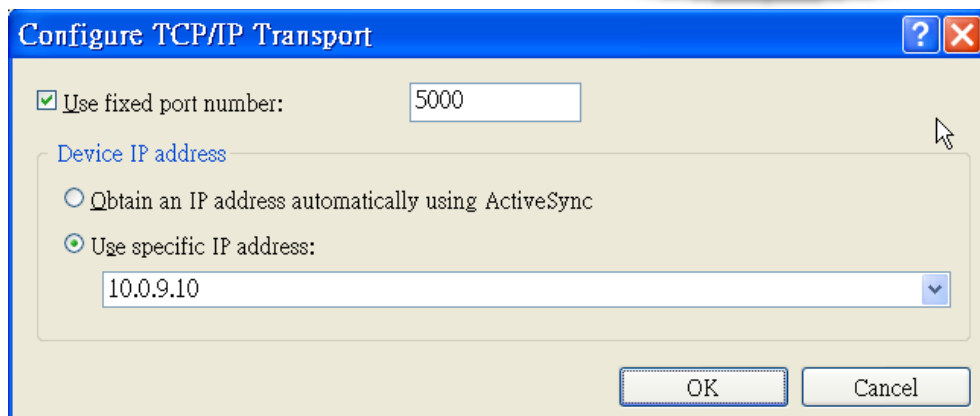
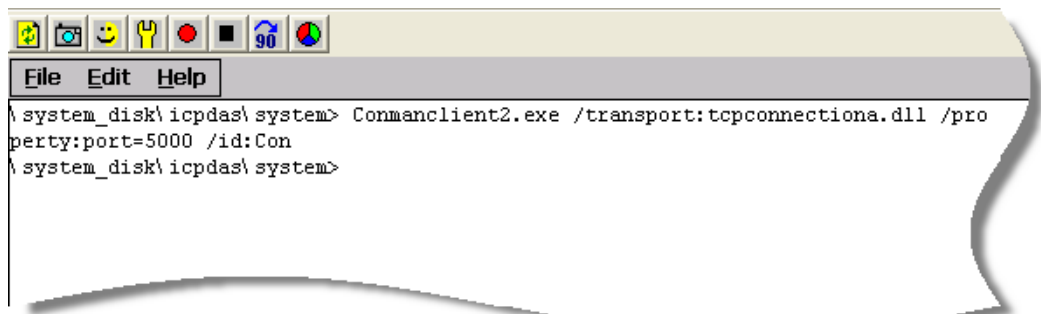

C.3. How to recompile WinCon programs

To recompile Wincon programs to run on ViewPAC, certain components of the programs require adjustments that divides into two parts:

1. Compiler old programs which ran on Wincon 8x3x and 8x4x
2. Modify .vcp file to upgrade the old WinCon project

Tips & Warnings



In general, you only need to do part 1, after this, if the program still can't be compiled to an application, the part 2 just need to do.

C.3.1. Compiler old programs which ran on Wincon 8x3x and 8x4x

Step 1: Open project which programmed in WinCon using eMbedded Visual C++

Step 2: On the “Build” menu, click “Configurations” command

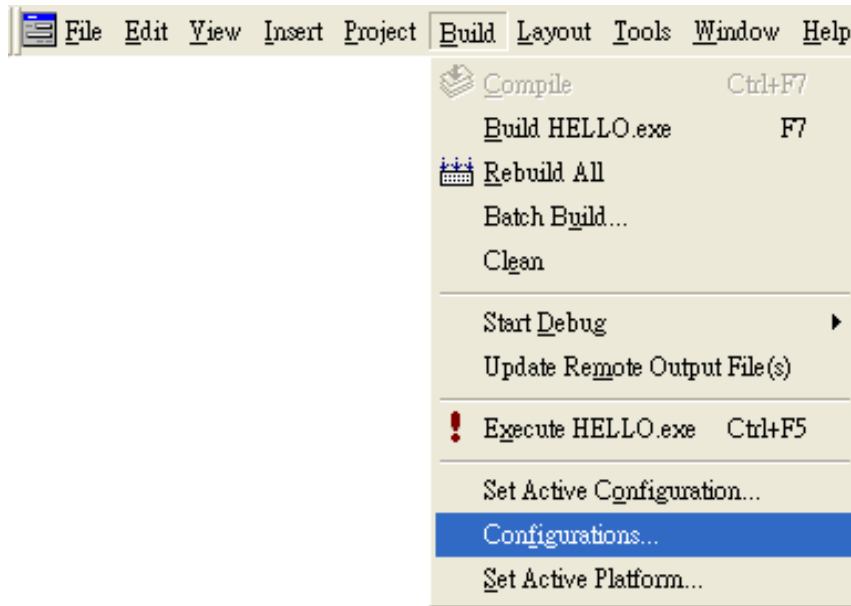

Step 3: Make sure the CPU type is “STANDARDSDK”

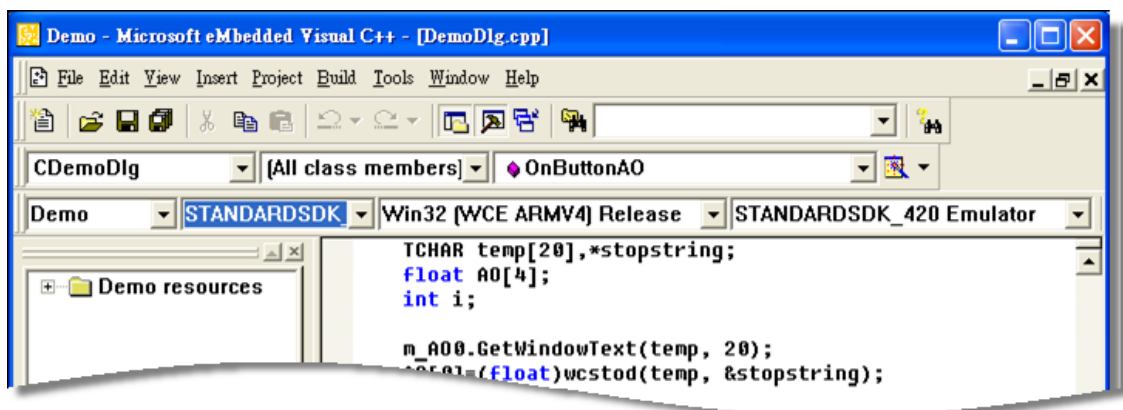

Step 4: On the “Configurations” dialog, click the “Add...” button

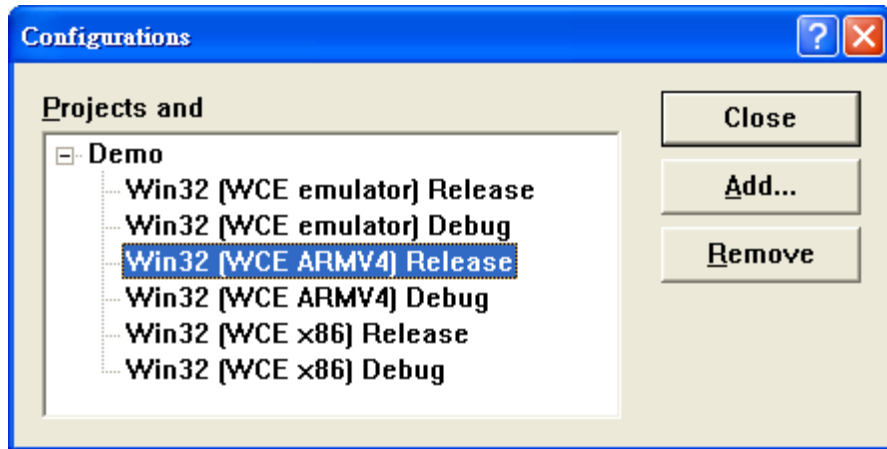

Step 5: On the “Add Project Configuration” dialog, choose one of the CPU type and then click the “OK” button.

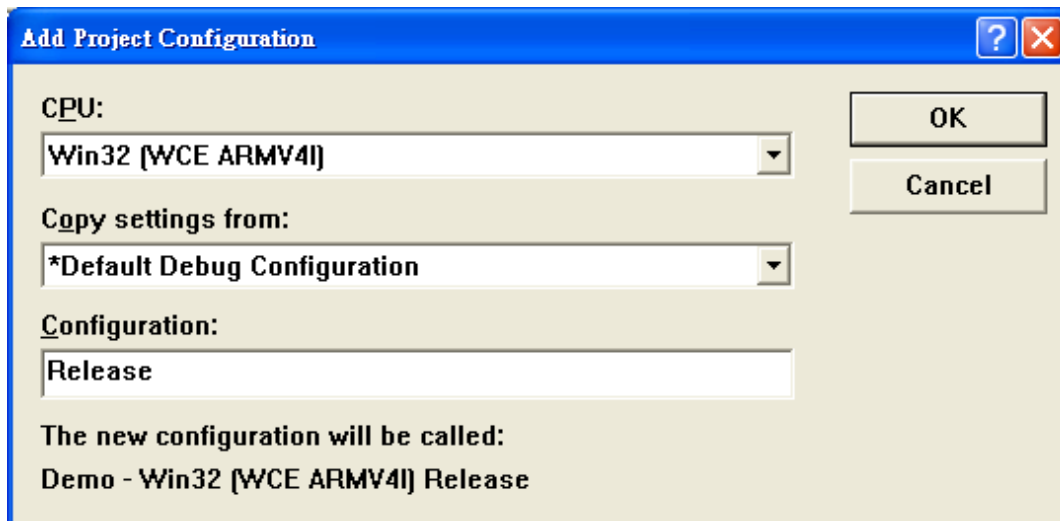

Step 6: On the “Project” menu, click “Settings...” command

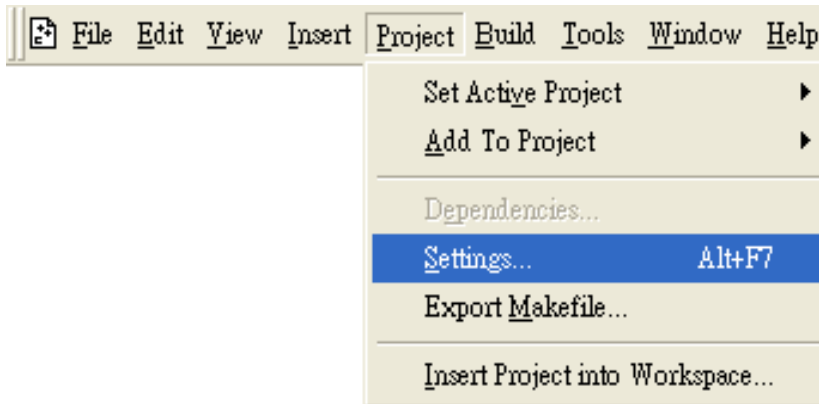

Step 7: On the “Project Settings” dialog, select the “Link” tab and change the value of the “Entry-point symbol” field, “WinMainCRTStartup” to “wWinMainCRTStartup”,

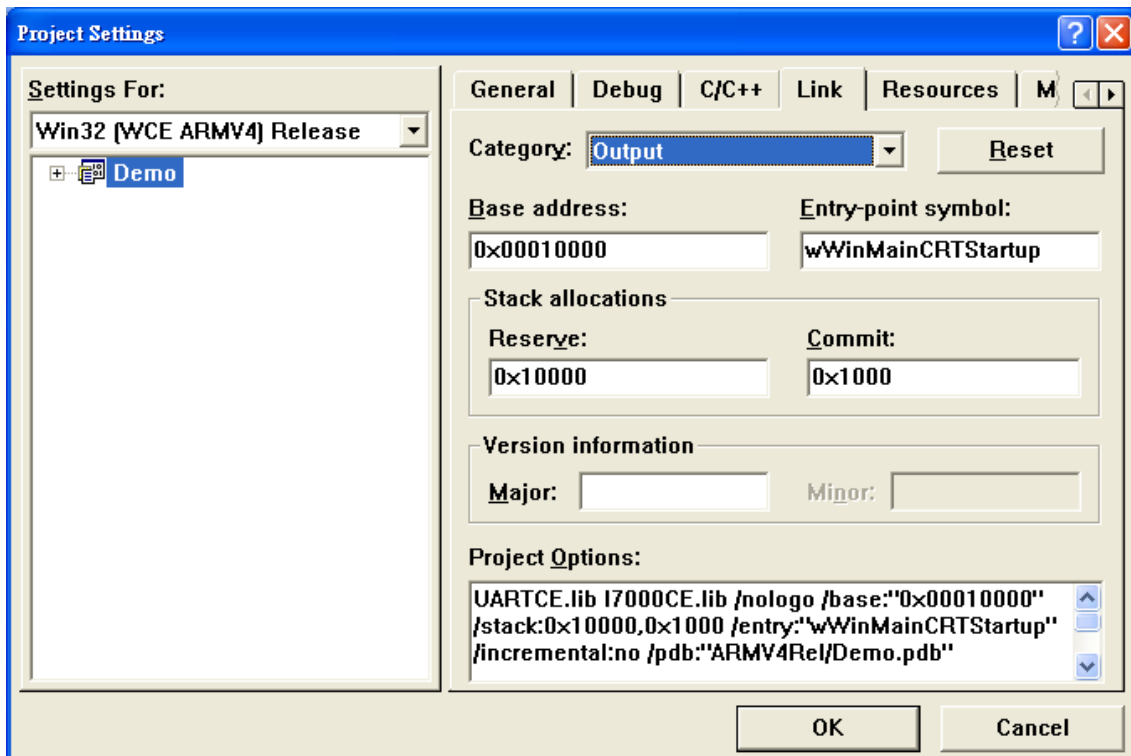

Step 8: After performing above-mentioned steps, build the project, your project should build success. If not, it will show error message as follow. Please continue with the following steps

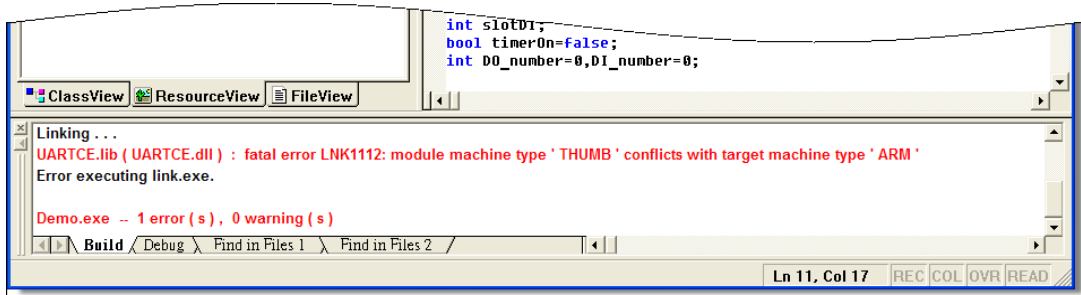

Step 9: On the “Project” menu, click “Settings...” command

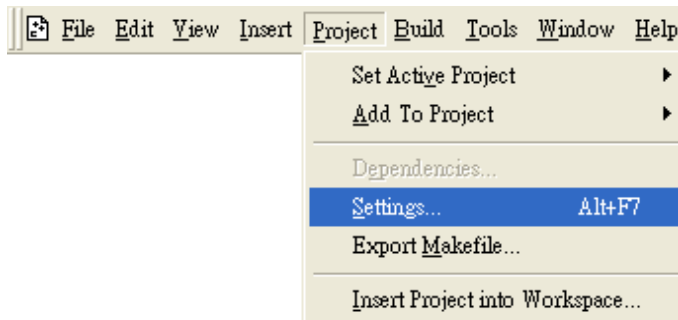

Step 10: On the “Project Settings” dialog, select the “Link” tab and change the value of the “Project Options” field, “ARM” to “THUMB”, and then built the project

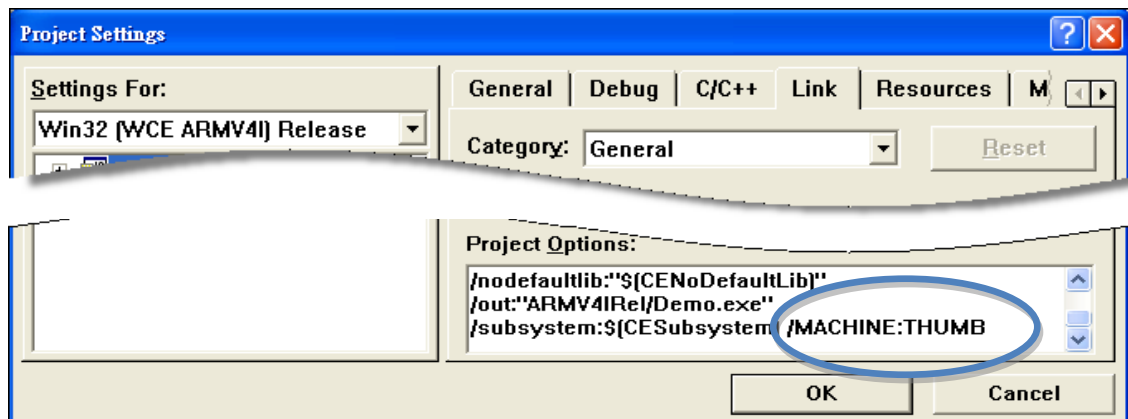

C.3.2. Modify .vcp file to upgrade the old WinCon project

Step 1: Open a text editor to modify the .vcp file

Step 2: In the .vcp file, replace “0xa301” with “0xa501”

Step 3: In the .vcp file, replace “ARMV4” with “ARMV4I”

Step 4: In the .vcp file, replace “MACHINE:ARM” with “MACHINE:THUMB”

Step 5: Save the .vcp file just edited

Step 6: Open the old WinCon project and recompile it

C.4. How to use the printer

ViewPAC have ability to access the printer, you can connect to the printer via Ethernet network or USB.

Tips & Warnings



ViewPAC only supports HP Laser Jet Printers which support PCL6 driver.

C.4.1. How to use network printer

To use a shared network printer, please perform the following steps:

Step 1: On the Host PC, check the name of the Host PC and the shared printer

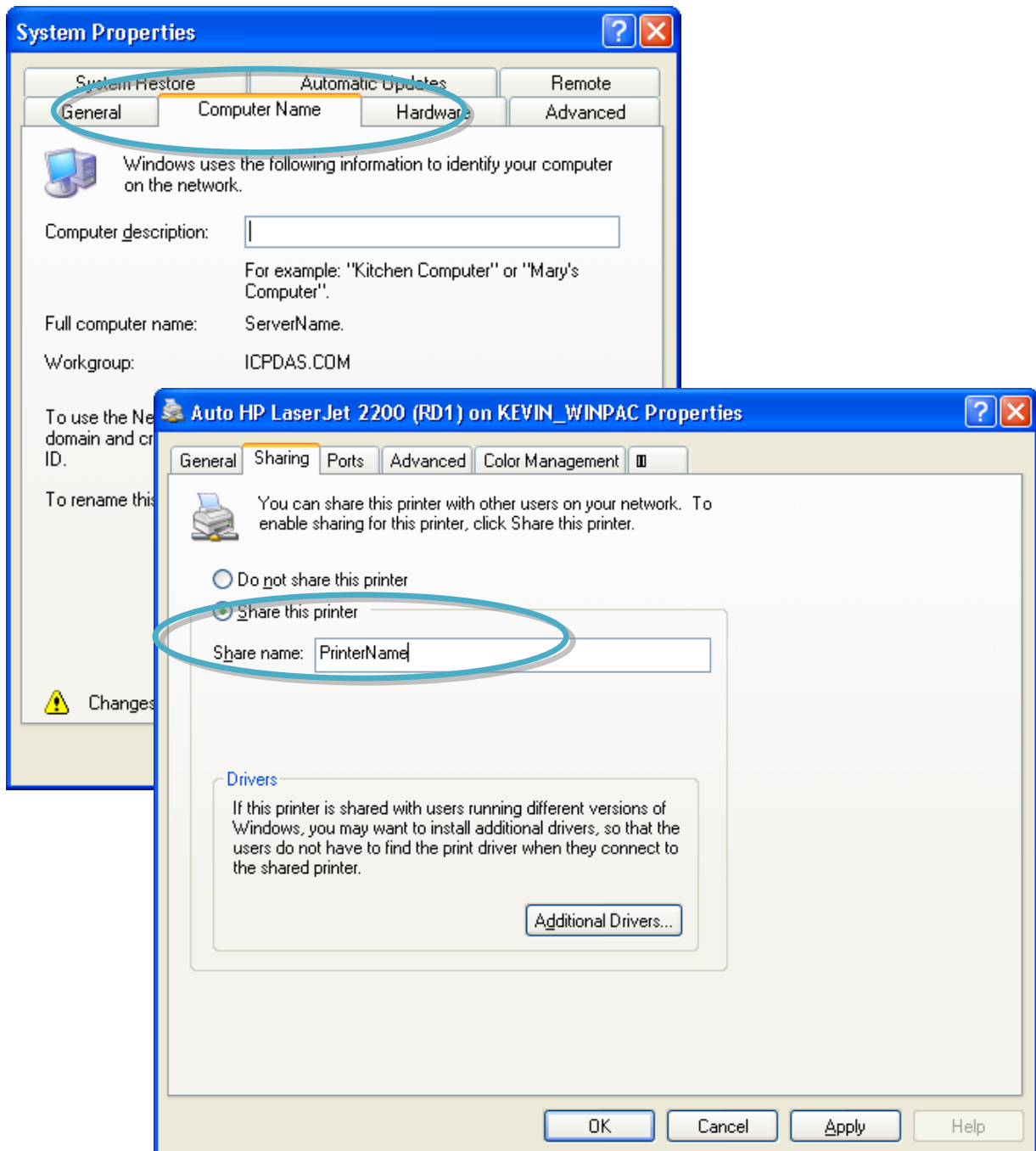

Step 2: On the ViewPAC, open a WordPad format file

Step 3: On the ViewPAC, open a WordPad format file

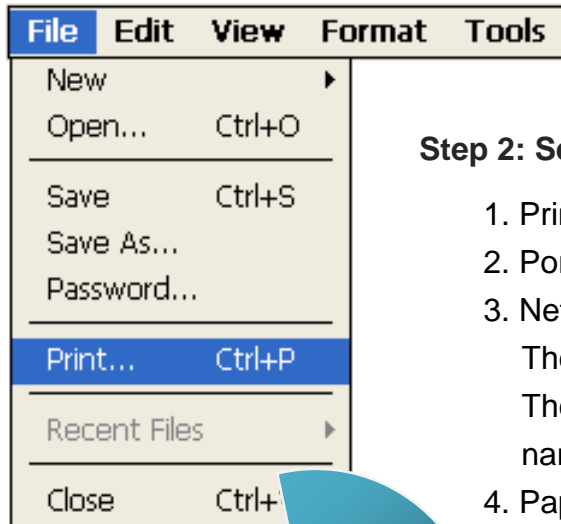

Step 2: Set up the printer

1. Printer: PCL Laser
2. Port: Network
3. Net Path: \\ServerName\PrinterName
The "ServerName" is your PC's name or IP.
The "PrinterName" is your printer's shared name of your PC
4. Paper Size: Select the paper size



Test !!!

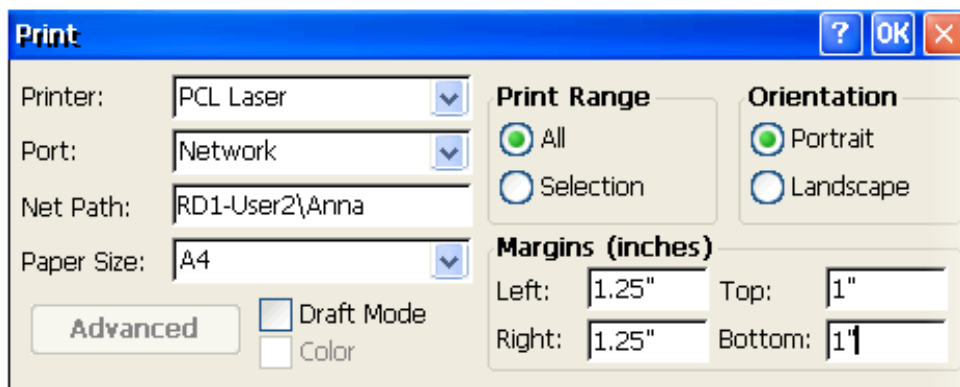

C.4.2. How to use printer via USB

To use a shared network printer via USB, please perform the following steps:

Step 1: On the ViewPAC, open a WordPad format file

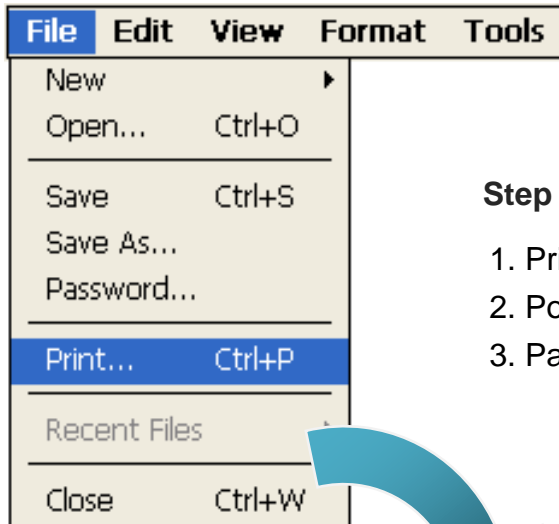

Step 2: Set up the printer

1. Printer: Hewlett-Packard LaserJet
2. Port: LPT1
3. Paper Size: Select the paper size



Test !!!

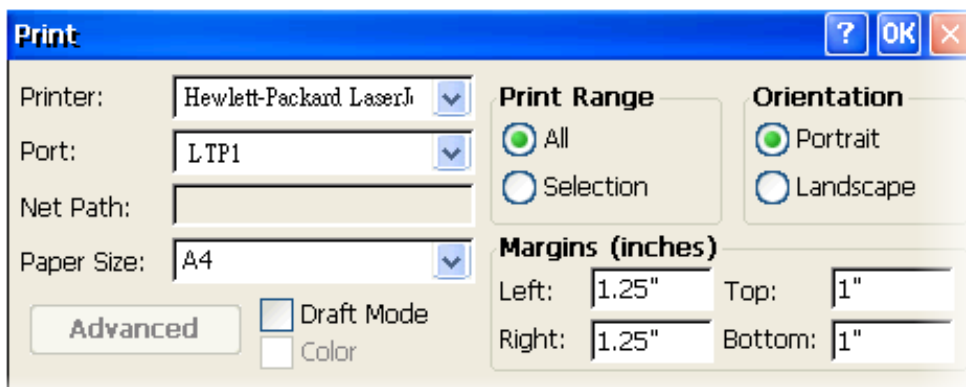

C.5. How to use services tool

The services tool can help you turn on, turn off and monitor the WinCE services.

Step 1: Open a MS-DOS command prompt

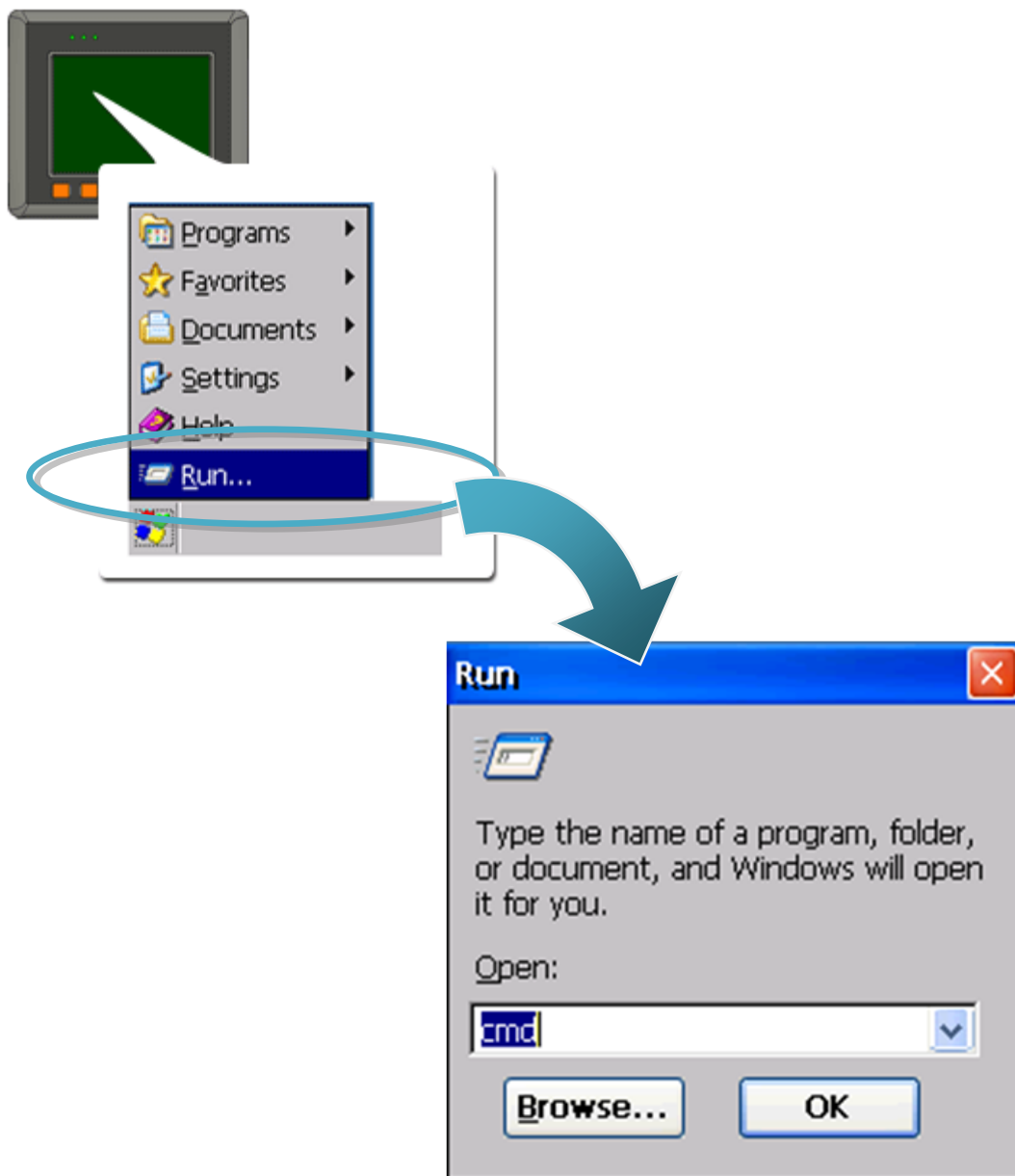

Step 2: List all services

[Syntax] services list

```
File Edit Help
Pocket CMD v 5.0
\> services list
NFYO: 0x00030110 NOTIFY.D11 Running
HTPO: 0x00031570 HTTPD.DLL Running
CRDO: 0x00032070 credsvc.dll Running
MMQ1: 0x00036790 MSMQD.D11 Off
OBX0: 0x00036b20 OBEXSrVr.dll Off
FTPO: 0x00037770 FTPD.D11 Running
TELO: 0x00037ac0 TELNETD.D11 Running
SMB0: 0x0003c3e0 smbserver.dll Running
NTPO: 0x0003ffff timesvc.dll Running
\>
```

Step 3: Type the commands to configure service

[Syntax] services stop <services name>

For example, turn on the “FTP” service:

services stop FTP0:

```
File Edit Help
Pocket CMD v 5.0
\> services stop FTP0:
\> services list
NFYO: 0x00030110 NOTIFY.D11 Running
HTPO: 0x00031570 HTTPD.DLL Running
CRDO: 0x00032070 credsvc.dll Running
MMQ1: 0x00036790 MSMQD.D11 Off
OBX0: 0x00036b20 OBEXSrVr.dll Off
FTPO: 0x00037770 FTPD.D11 Off
TELO: 0x00037ac0 TELNETD.D11 Running
SMB0: 0x0003c3e0 smbserver.dll Running
NTPO: 0x0003ffff timesvc.dll Running
\>
```

Tips & Warnings



For more information about using services tool, you just type “services help”

```
File Edit Help
Pocket CMD v 5.0
\> services help
Commands:
    help - print this text
    list - lists loaded services
    load <service name> - activates a service that is inactive
    stop <service instance> stops/pauses a service (does not unload)
    start <service instance> - starts/resumes a service
    refresh <service instance> - causes service to refresh its config
    unload <service instance> - causes service to be unloaded and
    register <service name> - service will be automatically loaded
reboot
    unregister <service name> - service will not be automatically
next reboot
    command <service name> [arg1 arg2 ...] - send service-specific
o service
    help <service name> - get information on what service-specific
are supported

    <service name> - service's name in the registry (i.e. HTTPD)
    <service instance> - particular instantiation (i.e. HTTPD:1)

Flags:
    -f <file name>
    -s silent
    -d output to debugger
\>
```

Appendix D. Revision History

Revision	Date	Description
1.0.1	August 2009	Initial issue
1.0.2	September 2009	Added information about the support of the printer driver in section C.4
1.0.3	December 2009	<ol style="list-style-type: none">1. Modified the operating modes in section 2.52. Added the requirements of the ViewPAC SDK in section 4.3.
1.0.4	February 2010	<ol style="list-style-type: none">1. Modified the specification of the Dual Battery Backup SRAM features in section 1.1.2. Modified information about Operating Environment in section 1.2.
1.0.5	January 2011	<ol style="list-style-type: none">1. Added information on how to use Backup Utility to back up the settings and files in section 2.9.2. Added information about a caution of using System_Disk in section 2.10.3. Added information about the ViewPAC Utility functionality in section in section 3.5.2.4. Deleted information on how to establish a new telnet and FTP account in section C.1.5. Added information on how to add a user account to remote login the ViewPAC from PC in section C.1.
1.0.6	July 2011	<ol style="list-style-type: none">1. Added information on the Overview in section 1.4.2. Modified information about the application of RS-485 network in appendix E.