

# VP-x231-CE7 Series

## User Manual

Version 1.0.1 May 2016

Service and usage information for

VP-1231-CE7/VP-4231-CE7/VP-6231-CE7



Written by Tunglu Yu  
Edited by Anna Huang

## Warranty

---

All products manufactured by ICP DAS are under warranty regarding defective materials for a period of one year, beginning from the date of delivery to the original purchaser.

## Warning

---

ICP DAS assumes no liability for any damage resulting from the use of this product. ICP DAS reserves the right to change this manual at any time without notice. The information furnished by ICP DAS is believed to be accurate and reliable. However, no responsibility is assumed by ICP DAS for its use, not for any infringements of patents or other rights of third parties resulting from its use.

## Copyright

---

Copyright © 2016 by ICP DAS Co., Ltd. All rights are reserved.

## Trademark

---

The names used for identification only may be registered trademarks of their respective companies.

### Contact US

If you have any problem, please feel free to contact us.

You can count on us for quick response.

Email: [service@icpdas.com](mailto:service@icpdas.com)

# Contents

<b>1. INTRODUCTION .....</b>	<b>6</b>
1.1. Features.....	7
1.2. Specifications .....	8
1.3. Overview .....	10
1.4. Dimensions.....	18
1.5. Companion CD.....	21
<b>2. GETTING STARTED.....</b>	<b>22</b>
2.1. Mounting the VP-x231-CE7.....	22
2.1.1. VP-1231-CE7 Installation .....	23
2.1.2. VP-4231-CE7 Installation .....	33
2.1.3. VP-6231-CE7 Installation .....	39
2.2. Configuring the Boot Mode.....	44
2.3. Changing the User Interface Language .....	46
2.4. Using PAC Utility to Manage the VP-x231-CE7.....	48
2.5. Using DCON Utility Pro Configure I/O Modules .....	49
<b>3. TOOLS AND TASKS.....</b>	<b>52</b>
3.1. PAC Utility.....	53
3.1.1. Menu Bar – File.....	54
3.1.2. Menu Bar – Help.....	55
3.1.3. Property Tab - General.....	56
3.1.4. Property Tab – General2.....	58
3.1.5. Property Tab – Display .....	59
3.1.6. Property Tab – IP Config .....	60
3.1.7. Property Tab – Network.....	61
3.1.8. Property Tab – Device Information.....	64
3.1.9. Property Tab – Auto Execution .....	65
3.1.10. Property Tab – Rotary Execution .....	66
3.2. DCON Utility Pro.....	67
3.3. TaskMgr.....	68
3.4. VCEP .....	69
3.5. Remote_Display .....	70
3.6. SendToCOM.....	71
3.7. RegEdit .....	72
3.8. ISQLW35 .....	73
3.9. INotepad.....	74

<b>4.</b>	<b>YOUR FIRST VP-X231-CE7 PROGRAM.....</b>	<b>75</b>
4.1.	Setting up the Development Environment.....	75
4.1.1.	Preparing the Development Tools and Programming Languages .....	76
4.1.2.	Installing the VP-x231-CE7 SDK .....	77
4.2.	First VP-x231-CE7 Program in VB.NET.....	78
4.2.1.	Create a new project .....	79
4.2.2.	Specify the path of the PAC reference.....	82
4.2.3.	Add the control to the form .....	84
4.2.4.	Add the event handling for the control.....	86
4.2.5.	Upload the application to VP-x231-CE7 .....	87
4.2.6.	Execute the application on VP-x231-CE7.....	89
4.3.	First VP-x231-CE7 Program in Visual C#.....	90
4.3.1.	Create a new project .....	91
4.3.2.	Specify the path of the PAC reference.....	94
4.3.3.	Add the control to the form .....	96
4.3.4.	Add the event handling for the control.....	98
4.3.5.	Upload the application to VP-x231-CE7 .....	99
4.3.6.	Execute the application on VP-x231-CE7.....	101
4.4.	First VP-x231-CE7 Program in Visual C++.....	102
4.4.1.	Create a new project .....	103
4.4.2.	Configure the Platform .....	108
4.4.3.	Specify the Path of PACSDK library and header files .....	109
4.4.4.	Add the control to the form .....	112
4.4.5.	Add the event handling for the control.....	115
4.4.6.	Upload the application to VP-x231-CE7 .....	117
4.4.7.	Execute the application on VP-x231-CE7.....	119
<b>5.</b>	<b>I/O EXPANSION MODULES AND SDKS SELECTION .....</b>	<b>120</b>
<b>6.</b>	<b>API RESOURCES AND DEMO REFERENCES.....</b>	<b>124</b>
6.1.	PAC Standard APIs for System Operation.....	125
6.1.1.	VB.NET Demos for PAC Standard APIs.....	126
6.1.2.	C# Demos for PAC Standard APIs.....	127
6.1.3.	Visual C++ Demos for PAC Standard APIs .....	128
6.2.	PAC Standard APIs for I/O Expansion .....	129
6.2.1.	VB.NET Samples for PAC Standard APIs.....	130
6.2.2.	C# Samples for PAC Standard APIs.....	132
6.2.3.	Visual C++ Samples for PAC Standard APIs .....	134
<b>7.</b>	<b>VP-X231-CE7 UPDATES .....</b>	<b>136</b>
7.1.	OS Updates.....	137

7.1.1.	OS Updates from Eshell .....	138
7.1.2.	OS updates using micro_SD.....	141
7.2.	SDK Updates .....	144
7.2.1.	SDK Updates for VB.NET or C# .....	145
7.2.2.	SDK Updates for VB.NET or Visual C++ .....	146
<b>8.</b>	<b>VIEWPAC DOWNLOAD CENTER.....</b>	<b>147</b>
	<b>TIPS &amp; HOW TO .....</b>	<b>148</b>
A.	I-8K and I-87K I/O Modules .....	149
B.	How to Change the Battery .....	150
C.	How to Online Debug the VP-x231-CE7 Program.....	152
D.	How to Automatically Synchronize VP-x231-CE7 Clock with an Internet Time Server .....	157
E.	How to Control the User Account Control in VP-x231-CE7 .....	159
E.1.	How to Create a User Account.....	160
E.2.	How to Use Telnet to Remote Login the ViewPAC from PC .....	162
E.3.	How to Remove a User Account from the Login List .....	164
F.	How to Use the Services Tool .....	165
G.	Revision History .....	167

# 1. Introduction

This chapter provides an overview of the VP-x231-CE7 and its components, and introduces the fundamental concepts for user familiar with the VP-x231-CE7.



The VP-x231-CE7 is the new generation Windows CE 7.0 based PAC (Programmable Automation Controller) of ICP DAS. Each VP-x231-CE7 is equipped with a Cortex-A8 (1.0 GHz) CPU running a Windows CE 7.0 operating system, a variant of input/output ports (VGA, USB, Ethernet, RS-232/485), and 3 expansion I/O slots that can be used to integrate high performance I-8K (parallel-type) and I-87K (serial-type) series I/O modules.

Its operating system, Windows CE 7.0, has many advantages, including hard real-time capability, small core size, fast boot speed, and interrupt handling at a deeper level, achievable deterministic control and low cost. Using Windows CE 7.0 in the VP-x231-CE7 gives it the ability to run PC-based Control software such as Visual Basic.NET, Visual C#, Embedded Visual C++, SCADA software, Soft PLC ...etc.

## 1.1. Features

The VP-x231-CE7 offers the most comprehensive configuration to meet specific application requirements. The following list shows the hardware and software features designed to simplify installation, configuration and application.

### Hardware Features

---

- Powerful CPU module
- Cortex-A8 1.0 GHz CPU
- Memory Size:
  - SDRAM (512 MB)
  - MRAM (128 KB)
  - Flash (256 MB)
  - FRAM (64 KB)
  - microSD card (support up to 32 GB)
- VGA Port x 1, USB 2.0 port x 1, Series port (RS-232/RS-485) x 2
- 64-bit Hardware Serial Number
- Dual Watchdog Timers
- Operating Temperature: -25 ~ +75 °C

### Software Features

---

- Windows Embedded Compact 7.0
- JavaScript and VBScript
- SQL Compact Edition 3.5
- .NET Compact Framework 3.5
- Remote Display
- Rich Software Solution – SDK for Microsoft Studio 2008

## 1.2. Specifications

The table below summarizes the specifications of the VP-x231-CE7.

Models	VP-1231-CE7	VP-4231-CE7	VP-6231-CE7
<b>System Software</b>			
OS	Windows CE 7.0		
.Net Compact Framework	3.5		
Embedded Service	FTP Server, Web Server (Supports VB script, JAVA script), Embedded SQL Server		
SDK Provided	DII for VC, DII for Visual Studio.Net 2008		
Multilanguage Support	English, German, French, Spanish, Russian, Italian, Korean, Simplified Chinese, Traditional Chinese		
<b>CPU Module</b>			
CPU	Cortex-A8 (32-bit and 1.0 GHz)		
SDRAM	512 MB (DDR3)		
MRAM	128 KB		
Flash	256 MB		
EEPROM	16 KB		
microSD	microSD socket with one microSD card (support up to 32 GB)		
RTC (Real Time Clock)	Provide second, minute, hour, date, day of week, month, year		
64-bit Hardware Serial Number	Yes, for software copy protection		
Dual Watchdog Timers	Yes (0.8 second)		
LED Indicator	3 Dual-Color LEDs (PWR, RUN, LAN1, L1, L2, L3; L1 to L3 for user programmable)	2 Dual-Color LEDs (PWR and RUN)	
Rotary Switch	Yes (0 to 9)		
<b>LCD Display</b>			
Size	5.7" (4:3)	10" (4:3)	15" (4:3)
Resolution	640 x 480	800 x 600	1024 x 768
Brightness	400		350
Contrast Ratio	250:1	500:1	
LED Backlight Life (hrs)	20,000		
Touch Panel	4-wire, resistive type; light transmission: 80 %	5-wire, resistive type; light transmission: 80 %	



Communication Interfaces			
Ethernet	RJ-45 x 1, 10/100/1000 Base-TX		
USB 2.0 (host)	1	2	
COM 2	RS-485 (D+, D-; self-tuner ASIC inside); 2500 V <sub>DC</sub> isolated		
COM 3	RS-232 (RxD, TxD, CTS, RTS, DSR, DTR, CD, RI and GND); Non-isolated		
Audio	Mic-in and Earphone-out	Earphone-out	Mic-in and Earphone-out
I/O Expansion Slots			
Number of I/O slots	3		
Supported types of I/O modules	I-8K and I-87K series I/O Modules		
Mechanical			
Dimensions (W x H x D), unit: mm	182 x 158 x 125	291 x 229 x 129	381 x 305 x 145
Panel Cut-out, unit: mm	153 x 136 ± 1.0	276 x 214 ± 1.0	366 x 290 ± 1.0
Ingress Protection	Front panel: IP65		
Installation	Panel mounting		
Environmental			
Operating Temperature	-20 °C to +70 °C		
Storage Temperature	-30 °C to + 80 °C		
Ambient Relative Humidity	10 % to 90 % RH (non-condensing)		
Power			
Input Range	+10 V <sub>DC</sub> to +30 V <sub>DC</sub>		
Redundant Power Inputs	-	Yes	
Isolation	1 kV		
Consumption	0.3 A @ 24 V <sub>DC</sub>	0.45 A @ 24 V <sub>DC</sub>	0.65 A @ 24 V <sub>DC</sub>

### 1.3. Overview

The VP-x231-CE7 is equipped with several interfaces and peripherals that can be integrated with external systems. Here is an overview of the components and its descriptions.

#### VP-1231-CE7

##### Front View

---

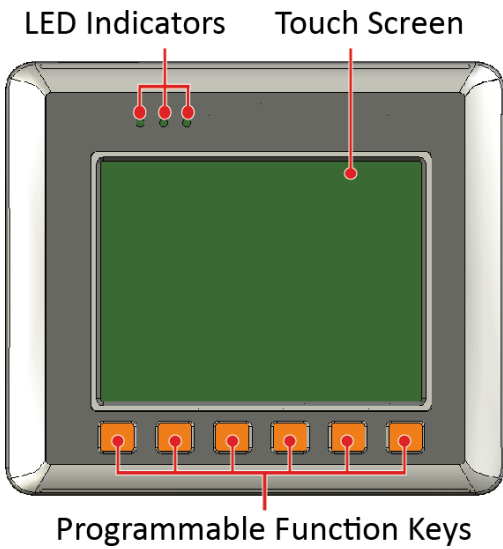

##### Side View

---

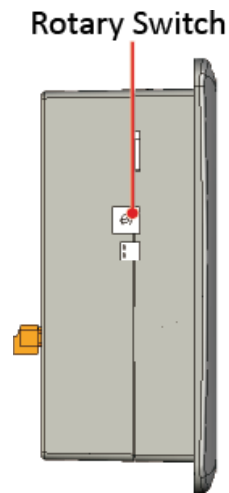

##### Back View

---

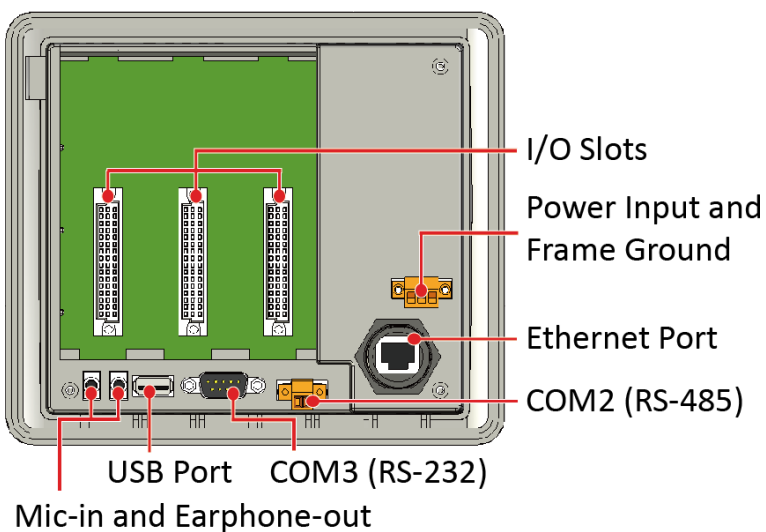

- **LED Indicators**

The VP-1231-CE7 has 3 Dual-Color LED indicators. The details of these LED indicators are as follows:

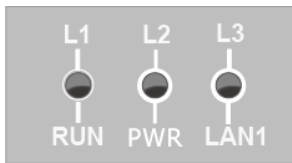

LED Indicator	Color	Status	Description
L1/L2/L3	Red	On	LED indicators controlled by user Program.
	Red	Off	
RUN	Green	On	System booted and ready.
	Green	Off	BIOS failure.
	Green	Blinking	System memory mapped out, formatted or defragmented.
PWR	Green	On	System has power applied to it.
	Green	Off	System is not powered on.
LAN1	Green	On	Link between system and network.
	Green	Off	Network disconnected.
	Green	Blinking	Network Access.

- **Touch Screen**

The VP-1231-CE7 is equipped with a touch screen to touch and change the settings.

- **Programmable Function Keys**

The VP-x231-CE7 provides support for keyboard input. The F1 to F6 function keys can be programmed by the user.

- **Rotary Switch**



Rotary Switch is an operating mode selector. The VP-x231-CE7 has several operating modes, for more detailed information about these operating modes. Please refer to “2.2. Configuring the Boot Mode”

- **I/O Slots**

The VP-x231-CE7 has 3 I/O slots that can be used to integrate high performance parallel I/O modules (high profile I-8K Series) or serial I/O modules (high profile I-87K series).

- **Power Input and Frame Ground**

The VP-x231-CE7 has a terminal with 3 pins, there are 2 pins for power input and a pin for frame ground as follows:

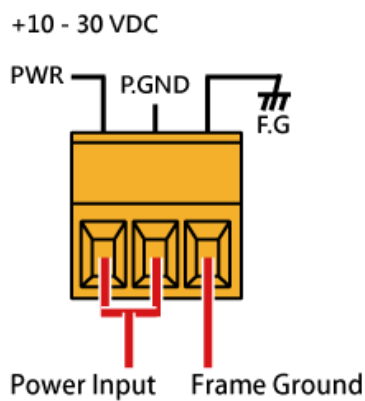

- **Ethernet Port**

The VP-x231-CE7 has an Ethernet port that can be used to connect that can be used to connect the router to the Internet or to other devices.

- **Mic-in and Earphone-out**

The VP-x231-CE7 has a microphone and an earphone jack to the input and output of sound system.

- **USB Port**

The VP-x231-CE7 has a USB 2.0 port that can be used to connect the USB devices such as mouse, keyboard or an external USB hard drive.

- **COM2**

COM2 port provides a connection to external RS-485 devices. The COM2 has 2 pins, as follows:

**Baud Rate:** 115200, 57600, 38400, 19200, 9600, 4800, 2400, 1200 bps

**Data Bits:** 7, 8

**Parity:** None, Even, Odd, Mark (Always 1), Space (Always 0)

**Stop Bits:** 1, 2

**FIFO:** 16 bytes

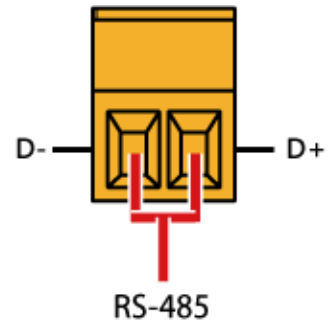

- **COM3**

The VP-x231-CE7 has one standard RS-232 serial communication interface port, COM3 (9-pin Sub-D plug connector). The details of this Pin assignment are as follows:

**Port Type:** Male

**Baud Rate:** 115200, 57600, 38400, 19200, 9600, 4800, 2400, 1200 bps

**Data Bits:** 5, 6, 7, 8

**Parity:** None, Even, Odd, Mark (Always 1), Space (Always 0)

**Stop Bits:** 1, 2

**FIFO:** 16 bytes

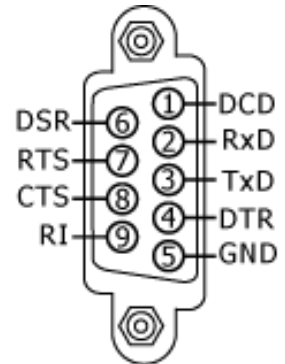

# VP-4231-CE7/CP-6231-CE7

## Front View

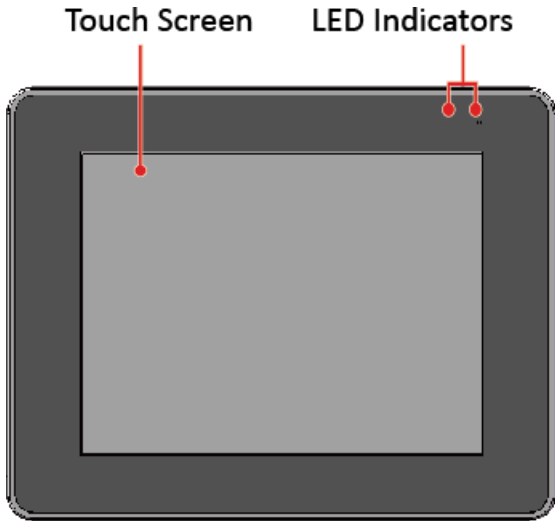

## Side View

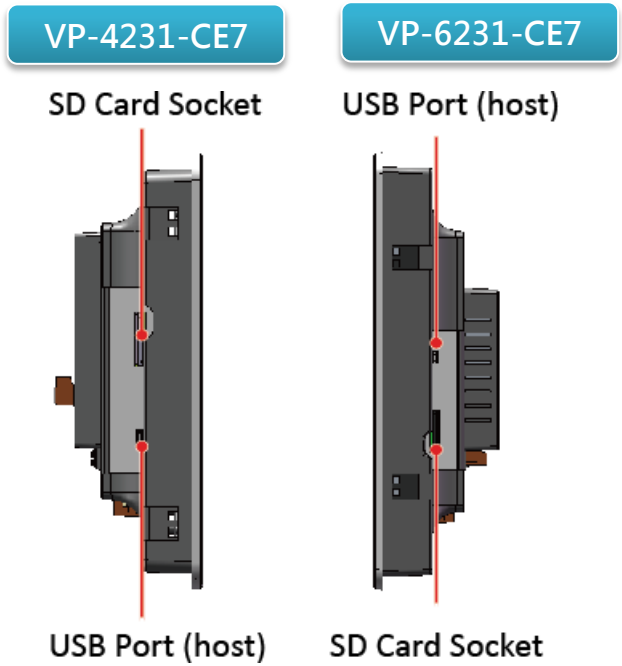

## Rear View

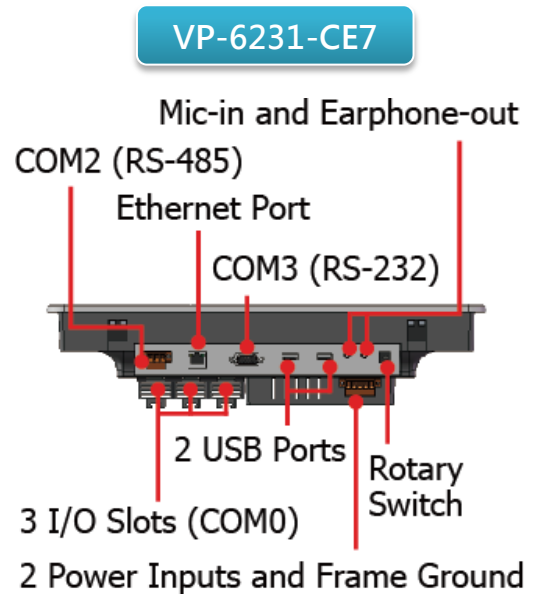
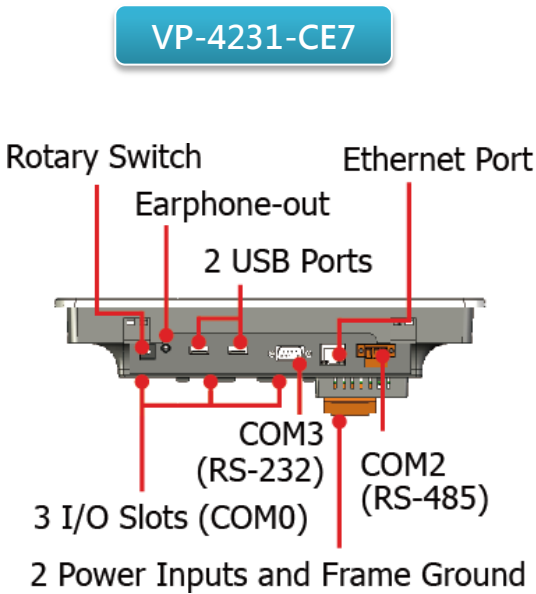

- **LED Indicators**

The VP-4231-CE7/VP-6231-CE7 has 2 Dual-Color LED indicators. The details of these LED indicators are as follows:



LED Indicator	Color	Status	Description
RUN	Red	On	Booting
	Red	Off	System booted and OS ready
PWR	Green	On	System has power applied to it
	Green	Off	System is not powered on

- **Touch Screen**

The VP-4231-CE7/VP-6231-CE7 is equipped with a touch screen to touch and change the settings.

- **SD Socket**

The SD socket can be used to restore the VP-4231-CE7/VP-6231-CE7 system and expand the memory up to 32 GB.

- **USB Host Port**

The USB host port allows you to connect a USB-compatible mouse, keyboard, or other plug-and-play peripherals and direct communication between data acquisition system and USB storage device.

- **Rotary Switch**

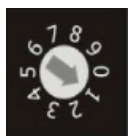

Rotary Switch is an operating mode selector. The VP-x231-CE7 has several operating modes, for more detailed information about these operating modes. Please refer to “2.2 Configuring the Boot Mode”

- **I/O Slots**

The VP-4231-CE7/VP-6231-CE7 has 3 I/O slots that can be used to integrate high performance parallel I/O modules (high profile I-8K Series) or serial I/O modules (high profile I-87K series).

- **Power Input and Frame Ground**

The VP-4231-CE7/VP-6231-CE7 has a terminal with 5 pins, there are 4 pins for redundant power inputs and a pin for frame ground as follows:

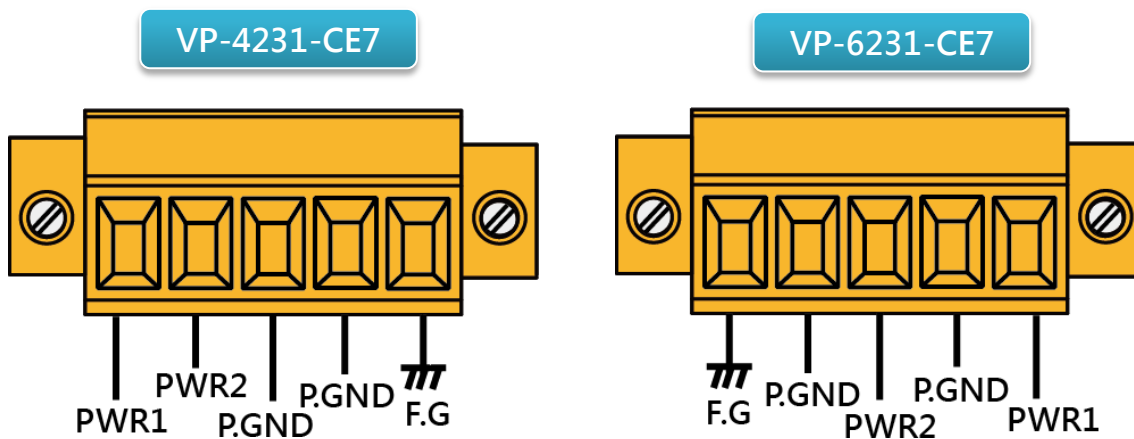

- **Ethernet Port**

The VP-4231-CE7/VP-6231-CE7 has an Ethernet port that can be connected to a computer or device via an Ethernet cable.

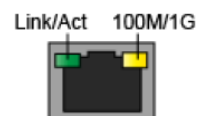

LED Indicator	Color	Status	Description
100M/1G	Orange	On	Network Speed: 1 G
	Orange	Off	Network Speed: 10/100 M
Link/Act	Green	On	The Link is active
	Green	Off	The Link is inactive
	Green	Blinking	Network activity

- **Earphone-out/Mic-in and Earphone-out**

The VP-4231-CE7/VP-6231-CE7 has an earphone/a microphone and an earphone jack to the input/input and output of sound system.



- **USB Port**

The VP-4231-CE7/VP-6231-CE7 has 2 USB 2.0 port that can be used to connect the USB devices such as mouse, keyboard or an external USB hard drive.

- **COM2 (RS-485)**

COM2 port provides a connection to external RS-485 devices. The COM2 has 2 pins, as follows:

**Baud Rate:** 115200, 57600, 38400, 19200, 9600, 4800, 2400, 1200 bps

**Data Bits:** 7, 8

**Parity:** None, Even, Odd, Mark (Always 1), Space (Always 0)

**Stop Bits:** 1, 2

**FIFO:** 16 bytes

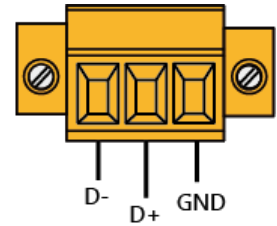

- **COM3 (RS-232)**

The VP-x231-CE7 has one standard RS-232 serial communication interface port, COM3 (9-pin Sub-D plug connector). The details of this Pin assignment are as follows:

**Port Type:** Male

**Baud Rate:** 115200, 57600, 38400, 19200, 9600, 4800, 2400, 1200 bps

**Data Bits:** 5, 6, 7, 8

**Parity:** None, Even, Odd, Mark (Always 1), Space (Always 0)

**Stop Bits:** 1, 2

**FIFO:** 16 bytes

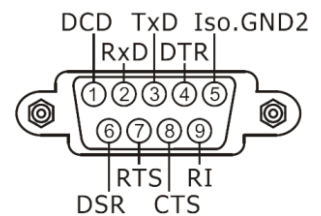

## 1.4. Dimensions

The diagrams below provide the dimensions of the VP-x231-CE7 to use in defining your enclosure specifications. Remember to leave room for potential expansion if you are using other components in your system.

### VP-1231-CE7

---

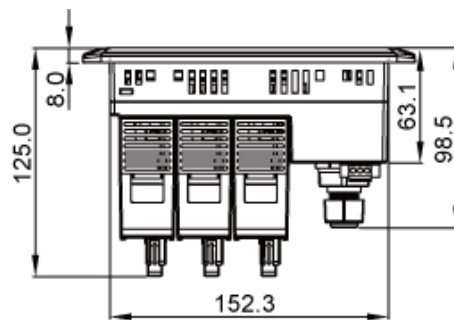

Top View

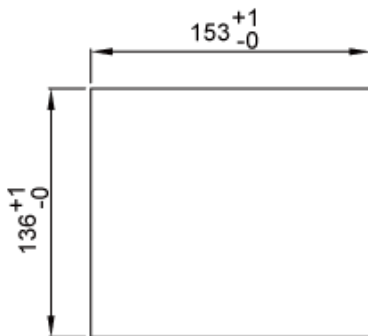

Recommended  
Panel Cut-Out

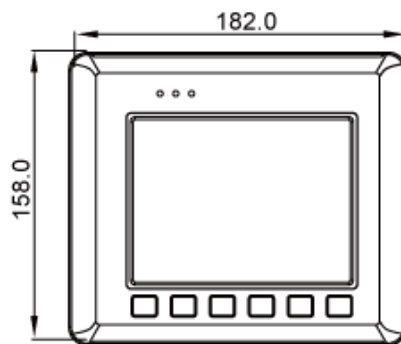

Front View

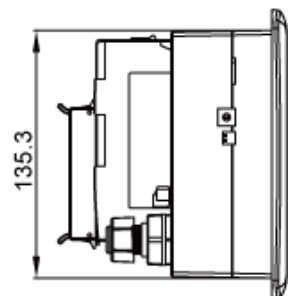

Right Side View

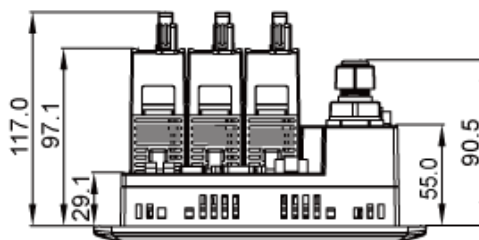

Bottom View

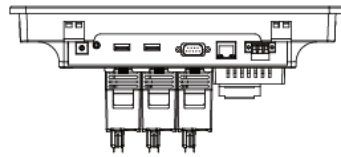

Top Veiw

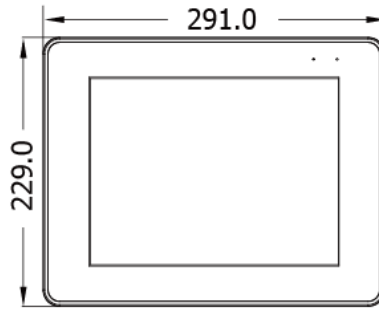
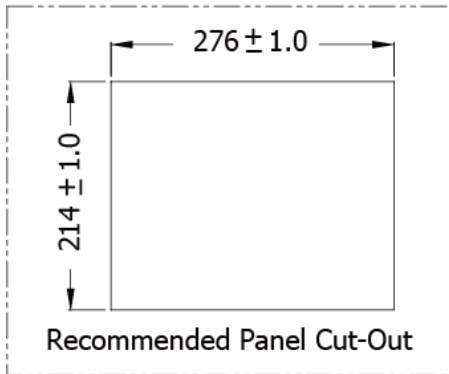

Front Veiw

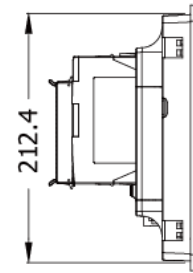

Right Side Veiw

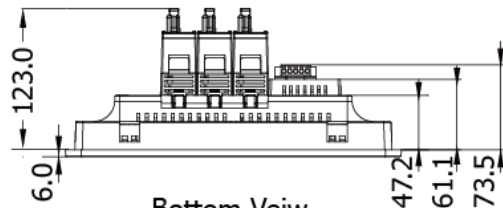

Bottom Veiw

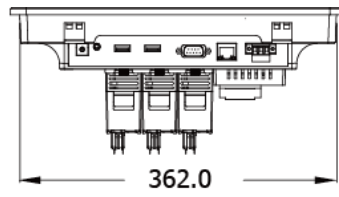

Top View

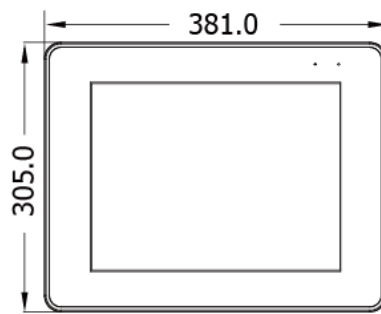
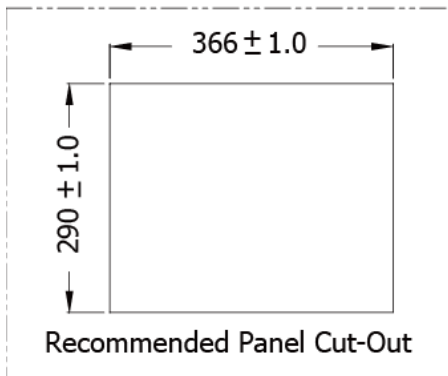

Front View

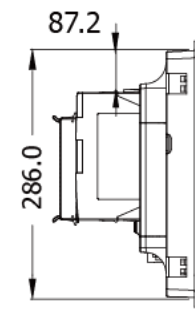

Right Side View

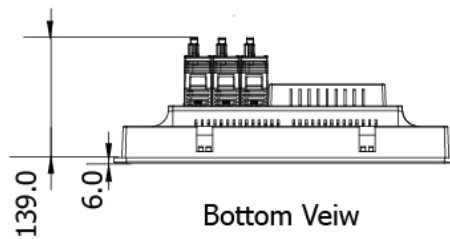

Bottom View

## 1.5. Companion CD

This package comes with a CD that provides a collection of the software utility, documentation, drivers, demo program and application. The CD contains several subdirectories located in \VP-x231 directory. All of them are listed below.

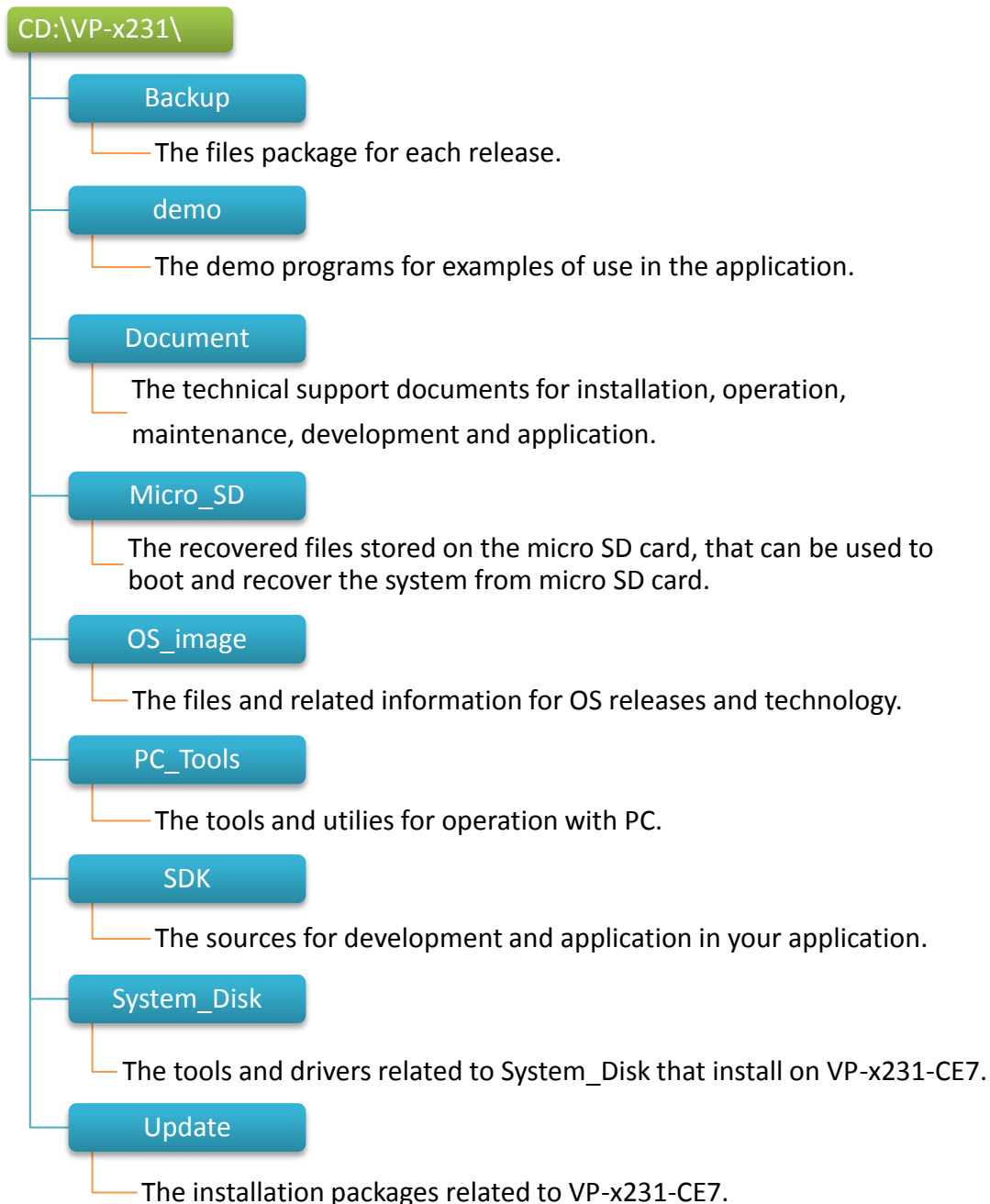

## 2. Getting Started

This chapter provides a guided tour of the VP-x231-CE7 installation and configuration that describes the steps needed to download, install, configure, and run the basic procedures for user working with the VP-x231-CE7 for the first time.

### 2.1. Mounting the VP-x231-CE7

Before you work with the VP-x231-CE7, you should have a basic understanding of hardware specification, such as the dimensions, the usable input-voltage range of the power supply, and the type of communication interfaces.

For more information about the hardware details, see section 1.2., “Specifications.”

For more information about the hardware dimensions, see section 1.4., “Dimensions.”

By hardware mechanism, the VP-x231-CE7 installation guide is divided into two sections, as follows:

1. For VP-1231-CE7 – section 2.1.1. VP-1231-CE7 Installation
2. For VP-4231-CE7 – section 2.1.2. VP-4231-CE7 Installation
3. For VP-6231-CE7 – section 2.1.3. VP-6231-CE7 Installation

## 2.1.1. VP-1231-CE7 Installation

Here is a brief of the steps to install the VP-1231-CE7.

### 2.1.1.1. Checking the Package Contents

Before starting any task, please check the package contents. If any of the following package contents are missing or damaged, contact your dealer, distributor.



VP-x231-CE7 and I/O  
socket x 3



Touch  
Panel



A microSD Card and A microSD  
to SD Adapter



Software  
Utility CD



RJ-45 Waterproofing  
Assembly



Screw  
Driver



Panel clip x 4



M4 x 30L  
Screw x 4

### 2.1.1.2. Removing the Slot Cover

The VP-1231-CE7 has a slot cover to protect the internal components from damage during shipping. Before starting any installation, please first remove the slot cover.

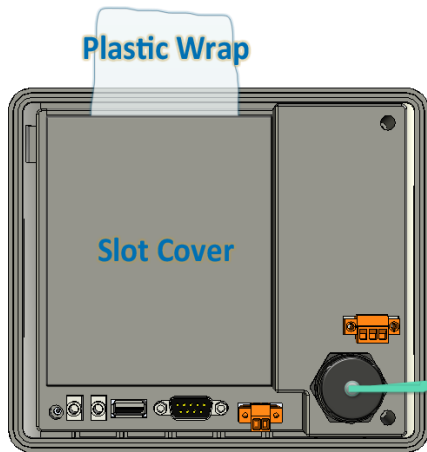

**Step 1: Hold the top of VP-1231-CE7**

**Step 2: Pull the plastic wrap**

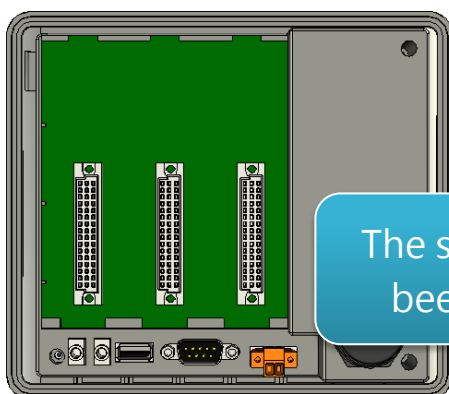
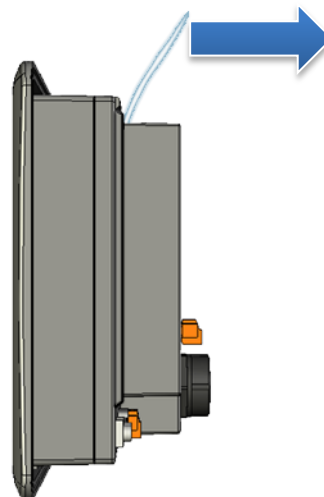

The slot cover has been removed



### 2.1.1.3. Installing Expansion I/O Sockets

The case (a socket and a top case) is included in the package. Before inserting the I/O modules you first need to install the expansion I/O socket.

**Step 1: Take the I/O socket out from the case**

**Step 2: Padlock the bottom of the I/O socket into the VP-1231-CE7**

**Step 3: Slide the socket into the VP-1231-CE7 until it clicks**

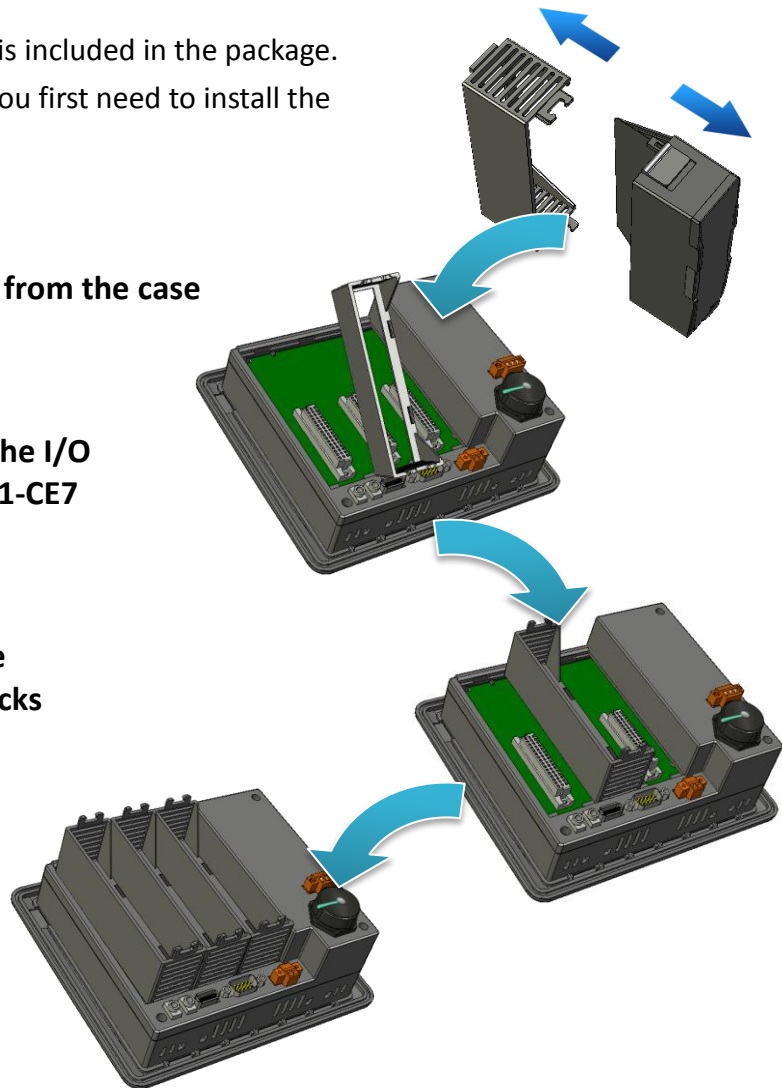

#### 2.1.1.4. Inserting and Wiring the I/O Modules

VP-1231-CE7 supports various types of I/O expansion modules for interfacing many different field devices. For more information about I/O expansion modules, please refer to:

[http://www.icpdas.com/products/PAC/winpac/io\\_support\\_list.htm](http://www.icpdas.com/products/PAC/winpac/io_support_list.htm)

**Step 1: Hold the I/O module vertically and align the socket**

**Step 2: Carefully press the I/O module onto the socket**

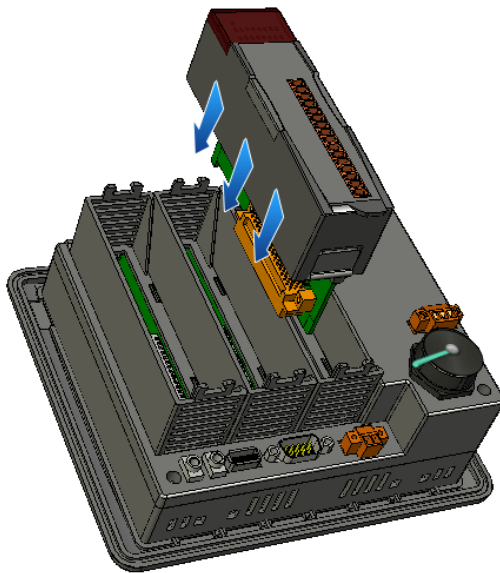

### 2.1.1.5. Installing the RJ-45 waterproof connector assembly

The VP-1231-CE7 is equipped with an RS-485 waterproof connector to withstand contaminant in dusty environment and immersion in water and corrosive elements.

#### Step 1: Remove the RJ-45 connector from the RJ-45 cable



#### Step 2: Feed the end of the RJ-45 cable through the (A) sealing nut, (B) rubber sealing insert, (C) clamping ring, (D) panel gasket and (E) cable gland base

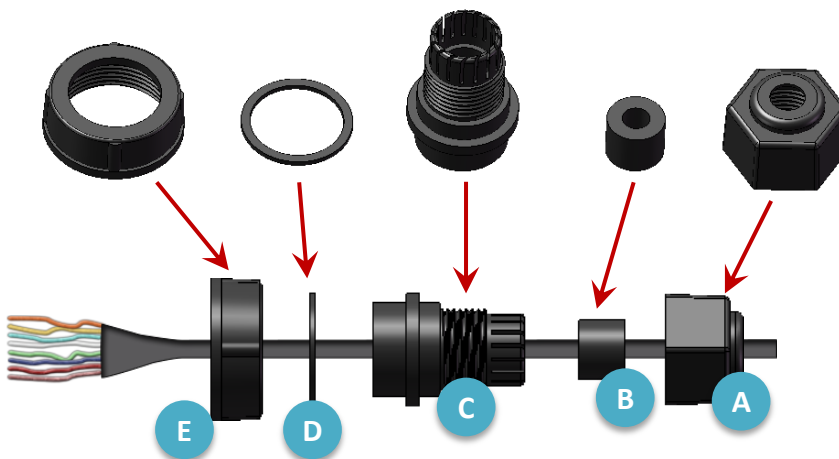

#### Step 3: Wrap the (C) clamping ring around the (B) rubber sealing insert

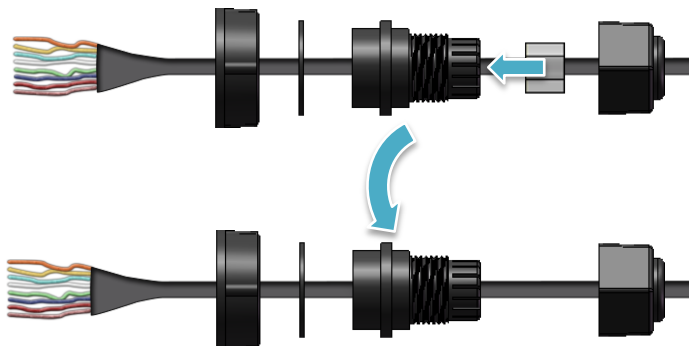

**Step 4: Insert the (D) panel gasket into the (C) clamping ring**

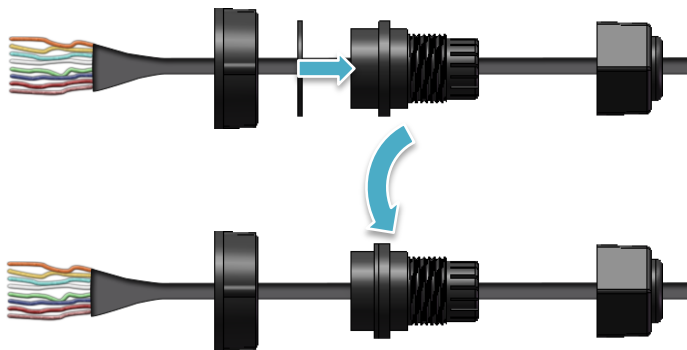

**Step 5: Seat the (C) clamping ring and (D) panel gasket in the (E) cable gland base**

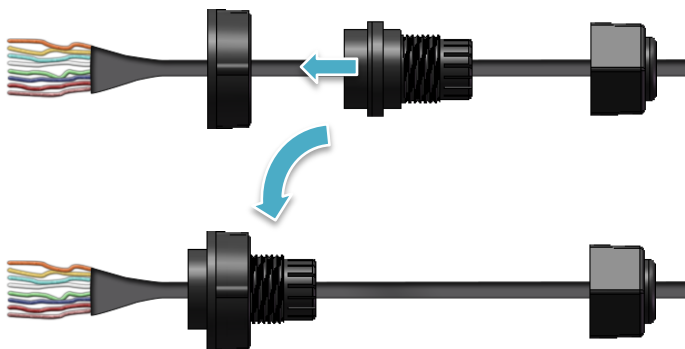

**Step 6: Push the (E) sealing nut forward and Hand-tighten it to seal the assembly**

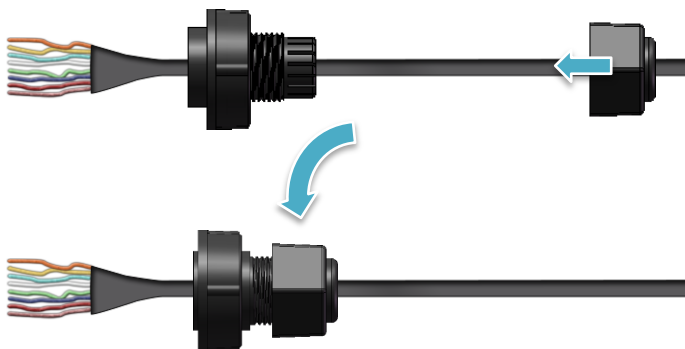

**Step 7: Insert the RJ-45 cable into the RJ-45 connector**

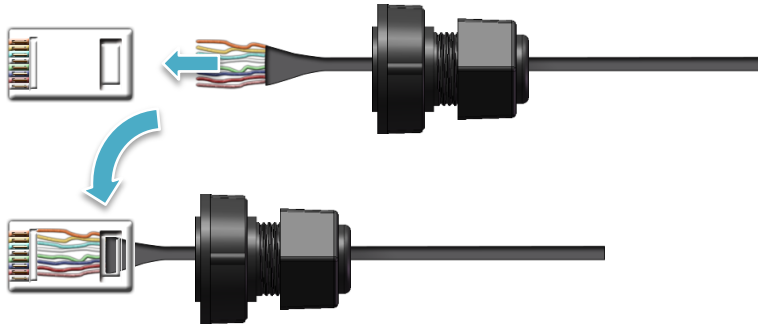

**Step 8: Push the RJ-45 waterproof connector assembly forward**



### 2.1.1.6. Mounting the VP-1231-CE7

The VP-1231-CE7 can be mounted on a panel of maximum thickness 12 mm. Adequate access space can be available at the rear of the instrument panel for wiring and servicing purposes.

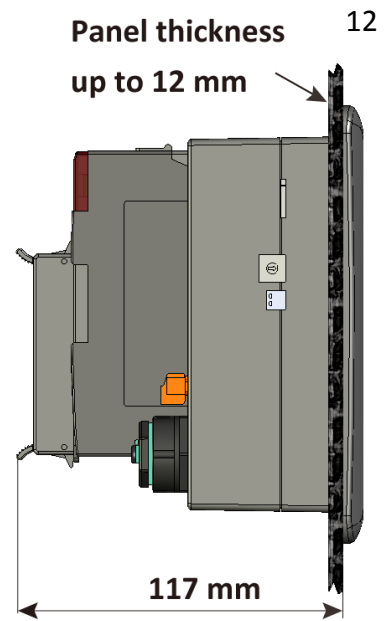

#### Tips & Warnings



To ensure proper ventilation for the VP-1231-CE7, leave a minimum of 50 mm space between the top and bottom edges of the VP-1231-CE7 and the enclosure panels.

**Step 1: Prepare the panel and cut the hole to the specified size**

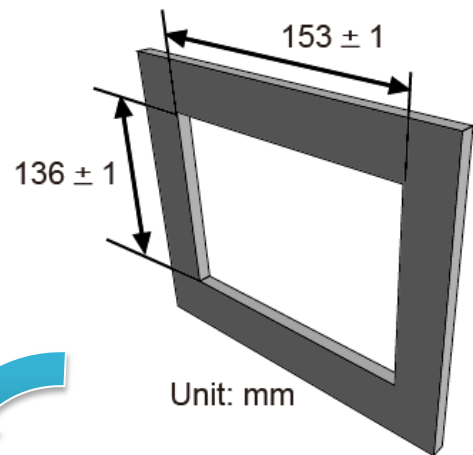

**Step 2: Attach the VP-1231-CE7 to the cut-out hole**

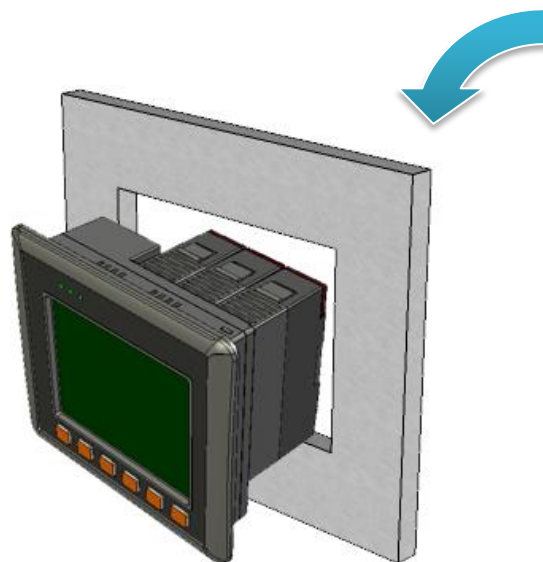

**Step 3: Insert the panel mounting clips into the upper and lower ventilation holes**

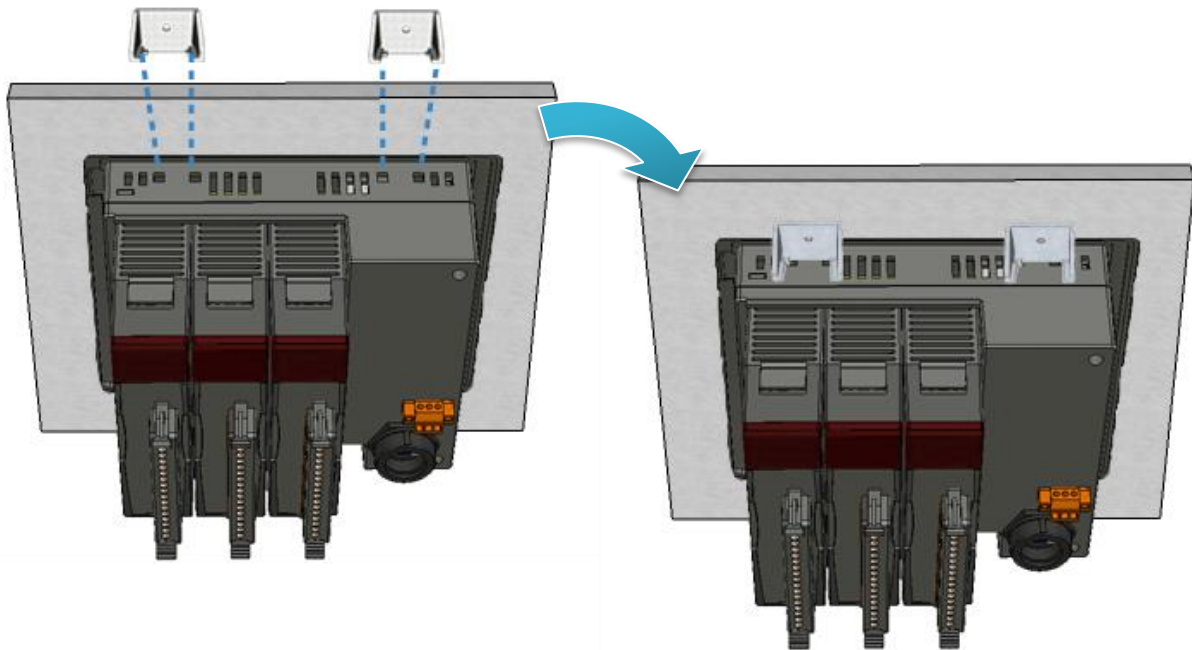

**Step 4: Screw the panel mounting clips to the panel.**

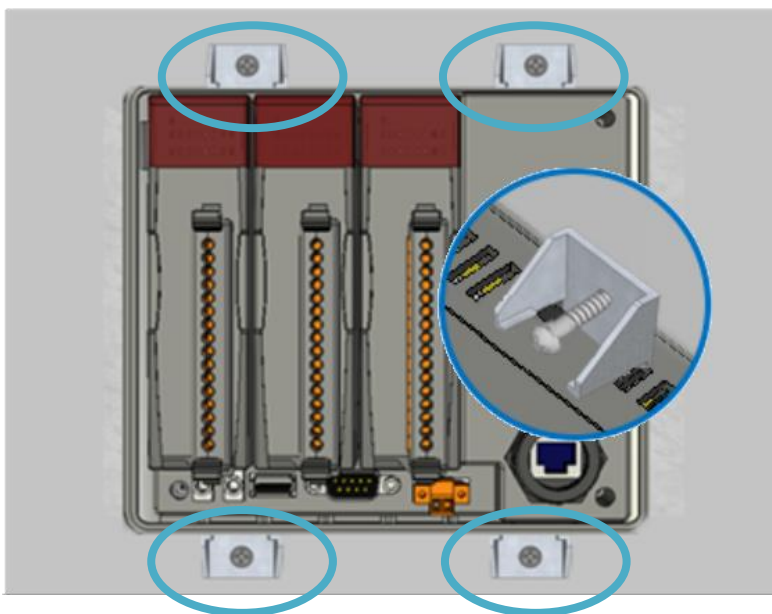

### Tips & Warnings



Recommended Screw Torque: 3.4 ~ 4.5 kgf-cm.

### 2.1.1.7. Deploying a Basic VP-1231-CE7 System

The VP-1231-CE7 provides a variety of communication interface to suit a range of application. Here is a simple application for using the VP-1231-CE7.

**Step 1: Connect the positive terminal (+) of the power supply to the terminal PWR1/2 and the negative terminal (-) of the power supply to the P.GND**

**Step 2: Connect the USB mouse or the USB keyboard to the USB port**

**Step 3: Connect the monitor to the VGA port**

**Step 4: Connect to PC or the laptop to the LAN port via an Ethernet switch**

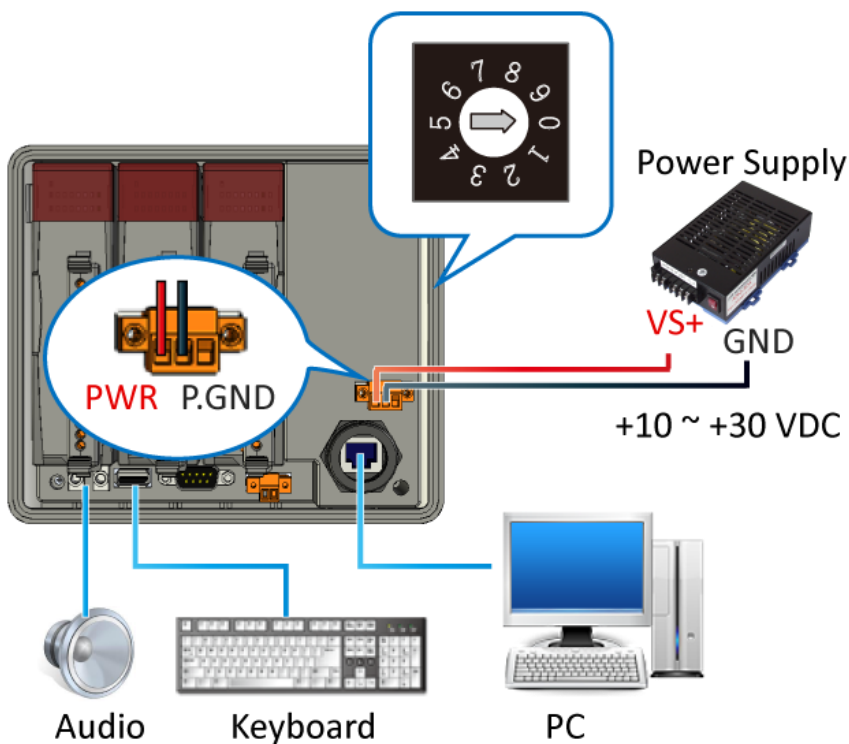



## 2.1.2. VP-4231-CE7 Installation

Here is a brief of the steps to install the VP-4231-CE7.

### 2.1.2.1. Checking the Package Contents

Before starting any task, please check the package contents. If any of the following package contents are missing or damaged, contact your dealer, distributor.



VP-4231-CE7 and  
I/O socket x 3



A microSD Card and a  
microSD to SD Adapter



Software  
Utility CD



Screw Driver



Panel clip x 4



M4 x 30L Screw x 4

### 2.1.2.2. Inserting the I/O Modules

There is a top case on each I/O socket. Before inserting the I/O module you first need to remove it.

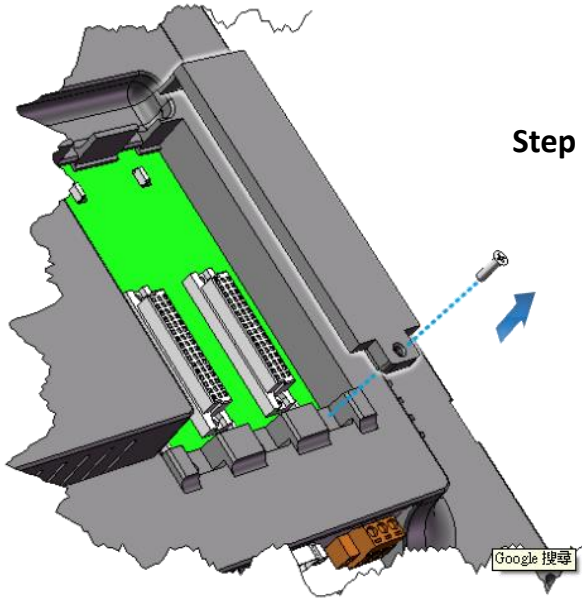

**Step 1: Use the screw driver to remove the screw and then remove the top case**

**Step 2: Hold the I/O socket vertically and align the VP-4231-CE7 socket and then carefully press the I/O socket onto the socket**

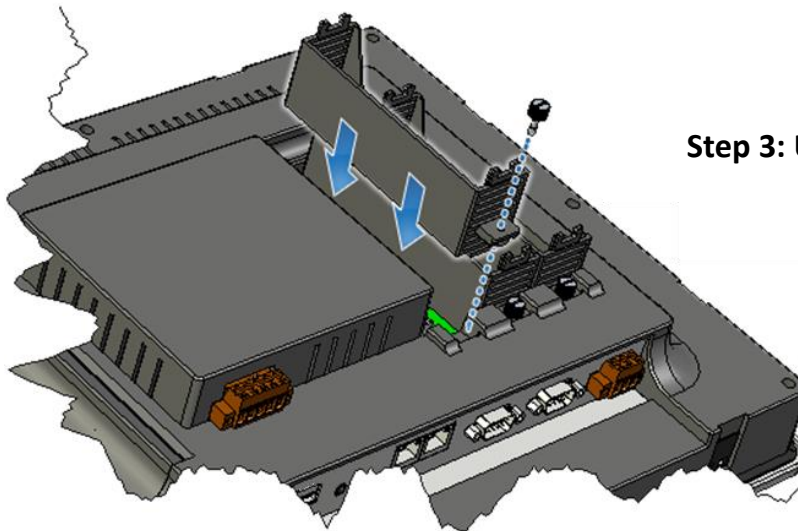

**Step 3: Use screw driver to screw tightly the screw**

**Step 4: Hold the I/O module vertically and align the socket and then carefully press the I/O module onto the socket**

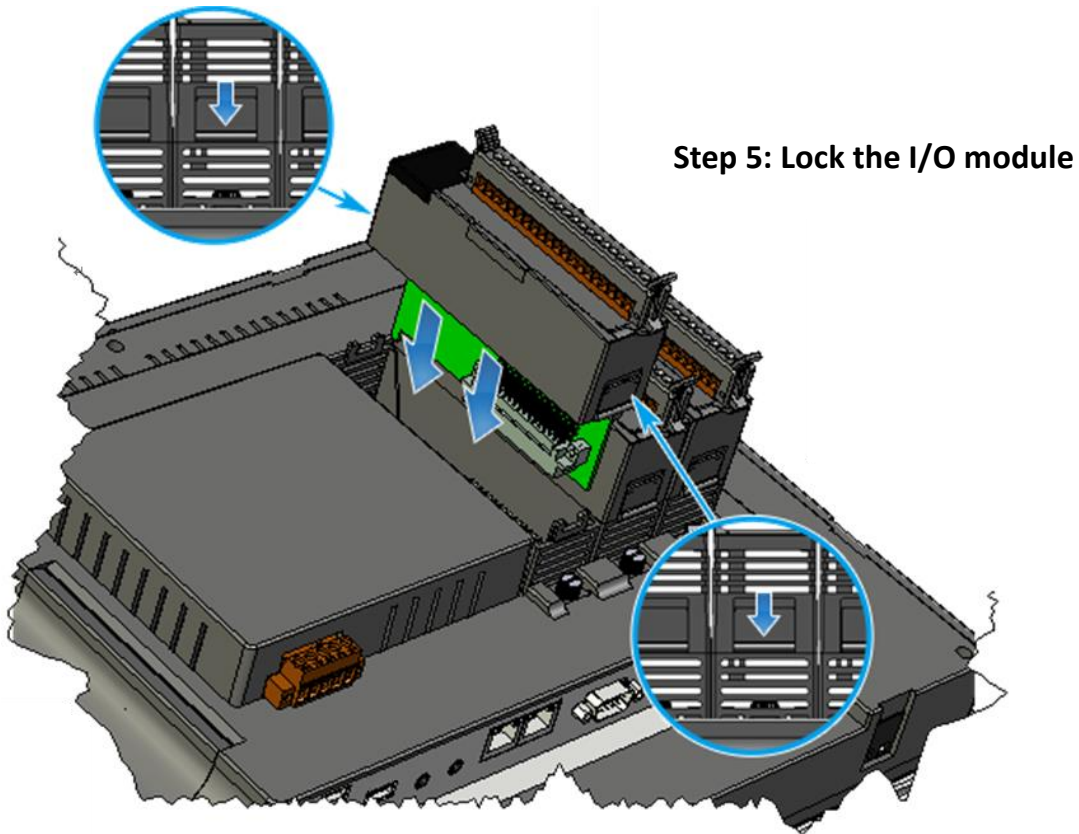

### Tips & Warnings

---



If you do not expand the I/O module full, please keep the top case of the unused slot to protect the backplane from dirt, dust and damage from foreign objects.

---

### 2.1.2.3. Mounting the VP-4231-CE7

The VP-4231-CE7 can be mounted on a panel of maximum thickness 5 mm. Adequate access space can be available at the rear of the instrument panel for wiring and servicing purposes.

#### Tips & Warnings



To ensure proper ventilation for the VP-4231-CE7, leave a minimum of 50 mm space between the top and bottom edges of the VP-4231-CE7 and the enclosure panels.

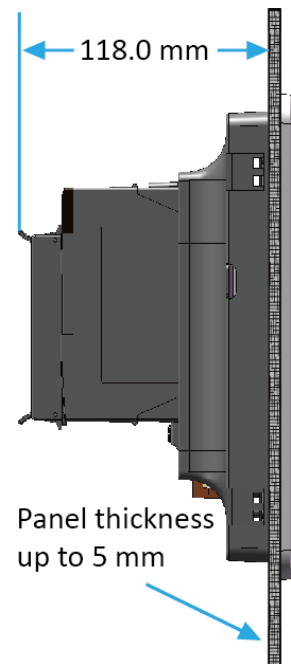

**Step 1: Prepare the panel and cut the hole to the specified size**

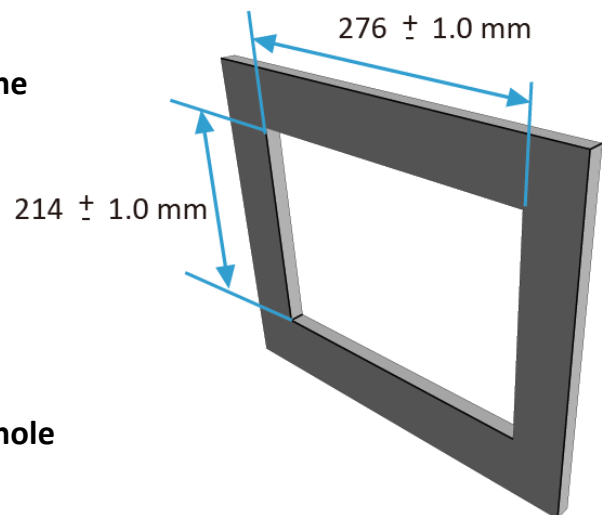

**Step 2: Attach the VP-4231-CE7 to the cut-out hole**



**Step 3: Insert the panel mounting clips into the upper and lower ventilation holes**

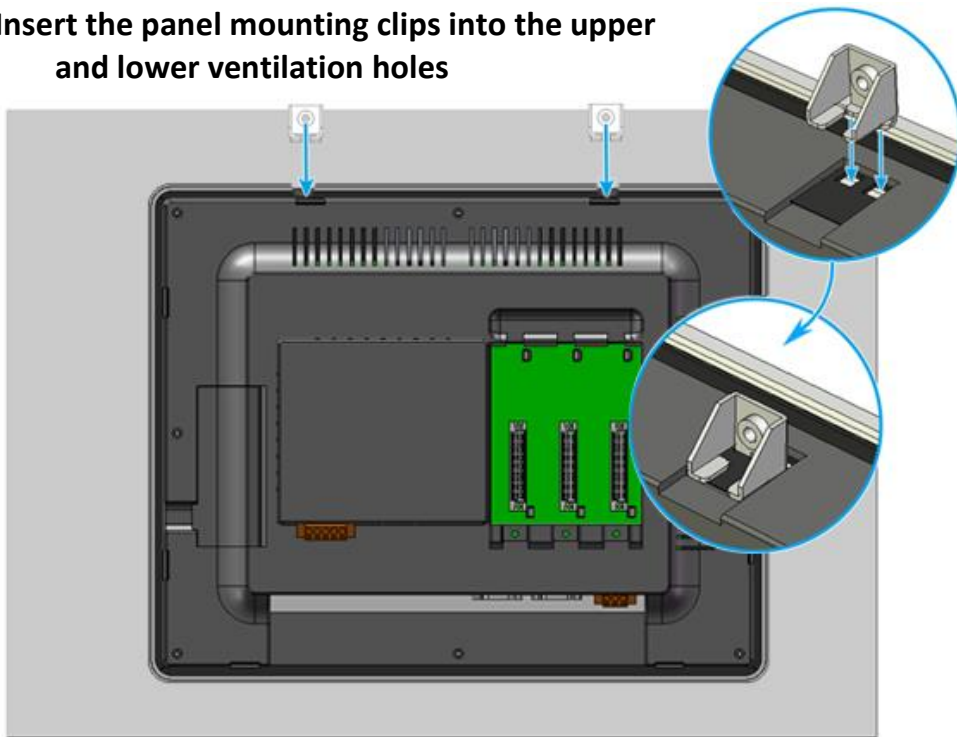

**Step 4: Screw the panel mounting clips to the panel**

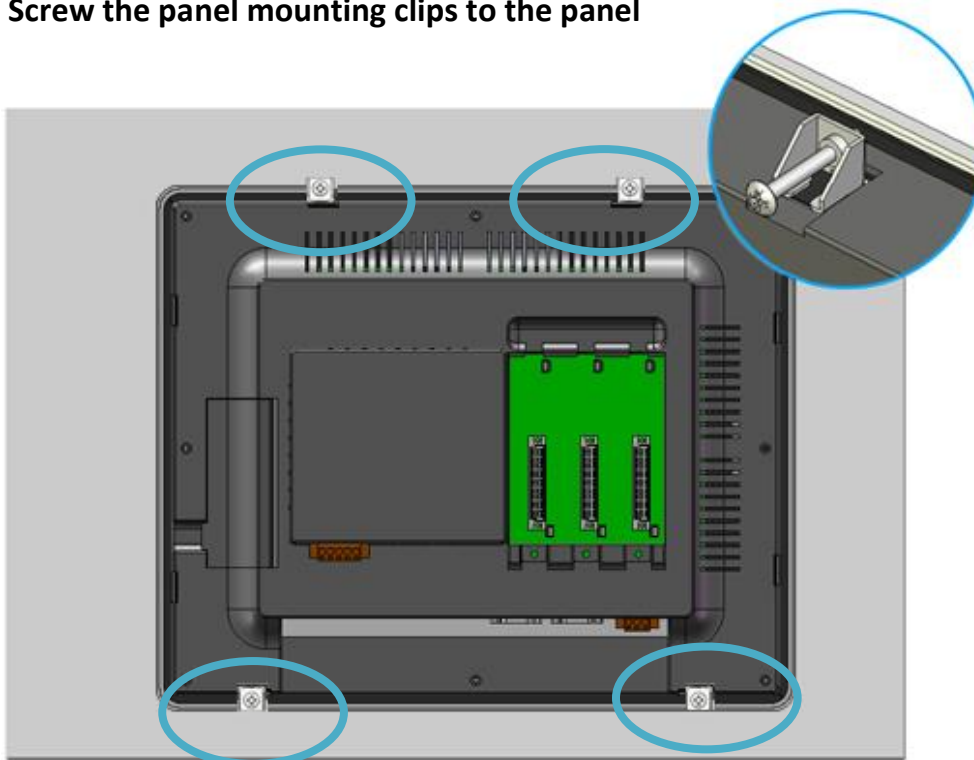

**Tips & Warnings**



Recommended Screw Torque: 3.4 ~ 4.5 kgf-cm.

#### 2.1.2.4. Deploying a Basic VP-4231-CE7 System

The VP-4231-CE7 provides a variety of communication interface to suit a range of application. Here is a simple application for using the VP-4231-CE7.

**Step 1: Connect the positive terminal (+) of the power supply to the terminal PWR1/2 and the negative terminal (-) of the power supply to the P.GND**

**Step 2: Connect the USB mouse or the USB keyboard to the USB port**

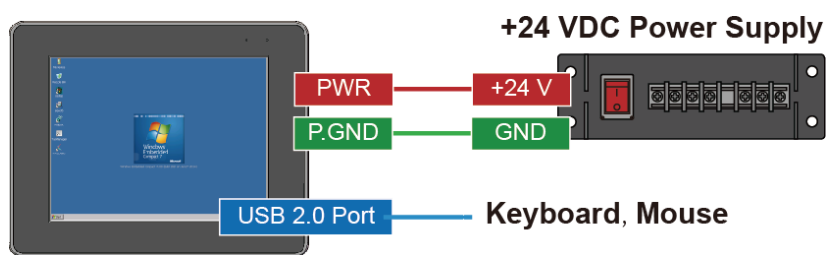

### 2.1.3. VP-6231-CE7 Installation

Here is a brief of the steps to install the VP-6231-CE7.

#### 2.1.3.1. Checking the Package Contents

Before starting any task, please check the package contents. If any of the following package contents are missing or damaged, contact your dealer, distributor.



VP-6231-CE7



A microSD Card and a  
microSD to SD Adapter



Software  
Utility CD



Screw Driver



Panel clip x 4



M4 x 30L Screw x 4



### 2.1.3.2. Inserting the I/O Modules

There is a top case on each I/O socket. Before inserting the I/O module you first need to remove it.

**Step 1: Unlock the top case of the I/O slot and then remove it**

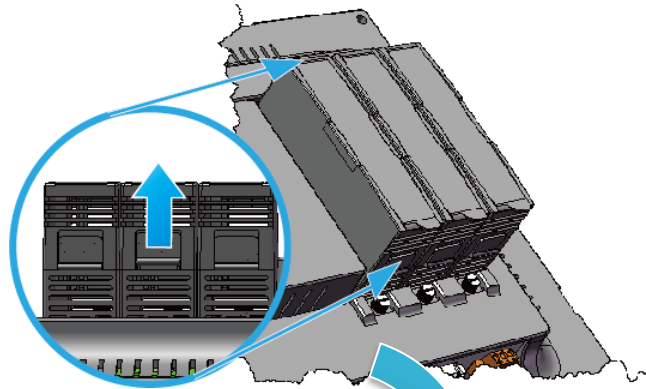

**Step 2: Hold the I/O module vertically and align the socket and then carefully press the I/O module onto the socket**

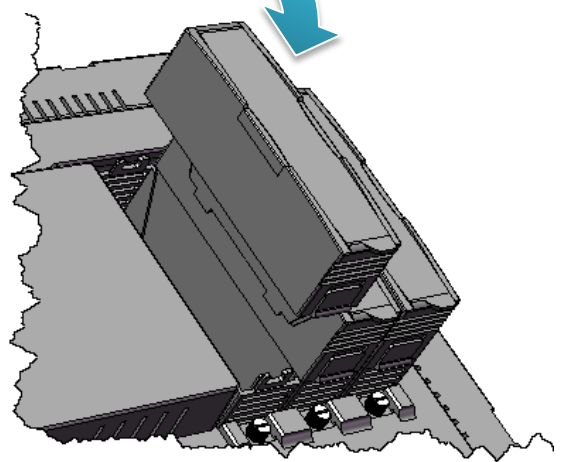

**Step 3: Lock the I/O module**

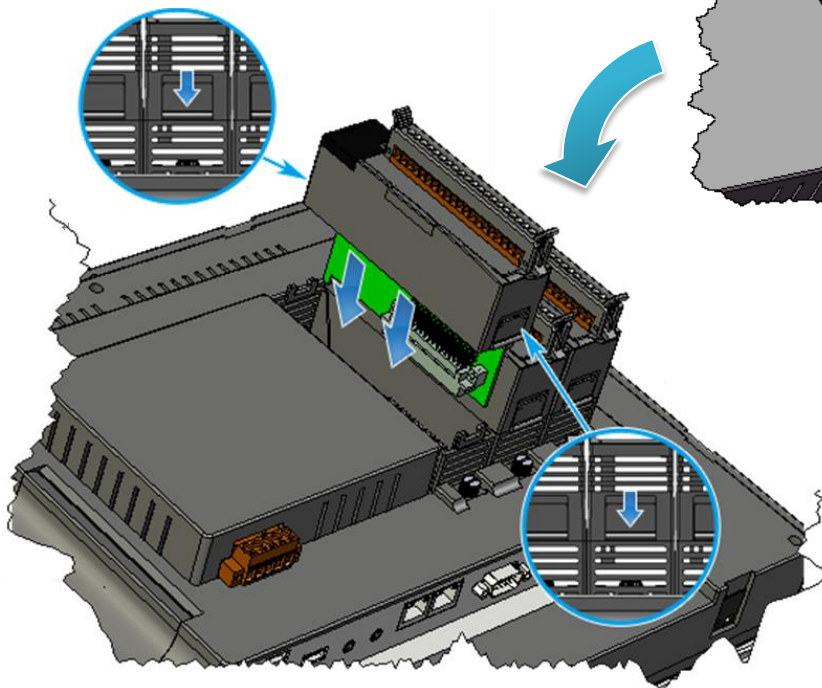

#### Tips & Warnings



If you do not expand the I/O module full, please keep the top case of the unused slot to protect the backplane from dirt, dust and damage from foreign objects.



### 2.1.3.3. Mounting the VP-6231-CE7

The VP-6231-CE7 can be mounted on a panel of maximum thickness 5 mm. Adequate access space can be available at the rear of the instrument panel for wiring and servicing purposes.

#### Tips & Warnings



To ensure proper ventilation for the VP-6231-CE7, leave a minimum of 50 mm space between the top and bottom edges of the VP-6231-CE7 and the enclosure panels.

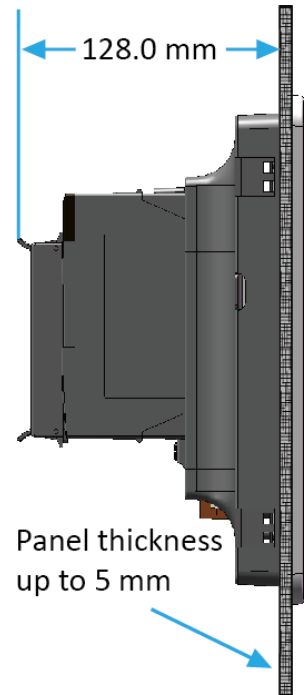

**Step 1: Prepare the panel and cut the hole to the specified size**

**Step 2: Attach the VP-6231-CE7 to the cut-out hole**

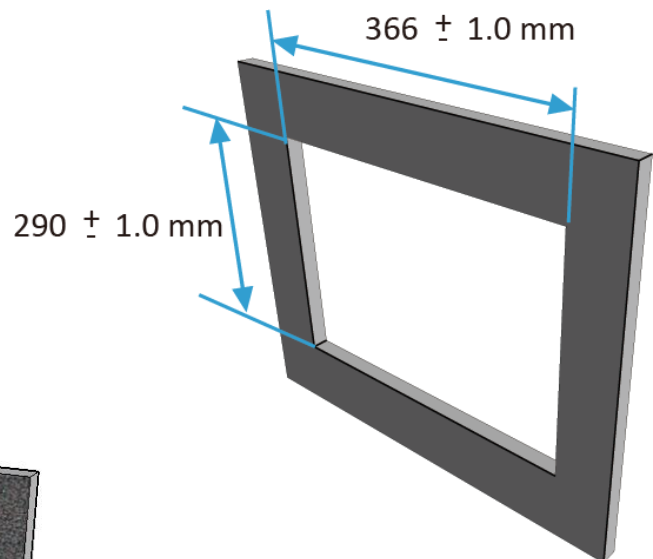

**Step 3: Insert the panel mounting clips into the upper and lower ventilation holes**

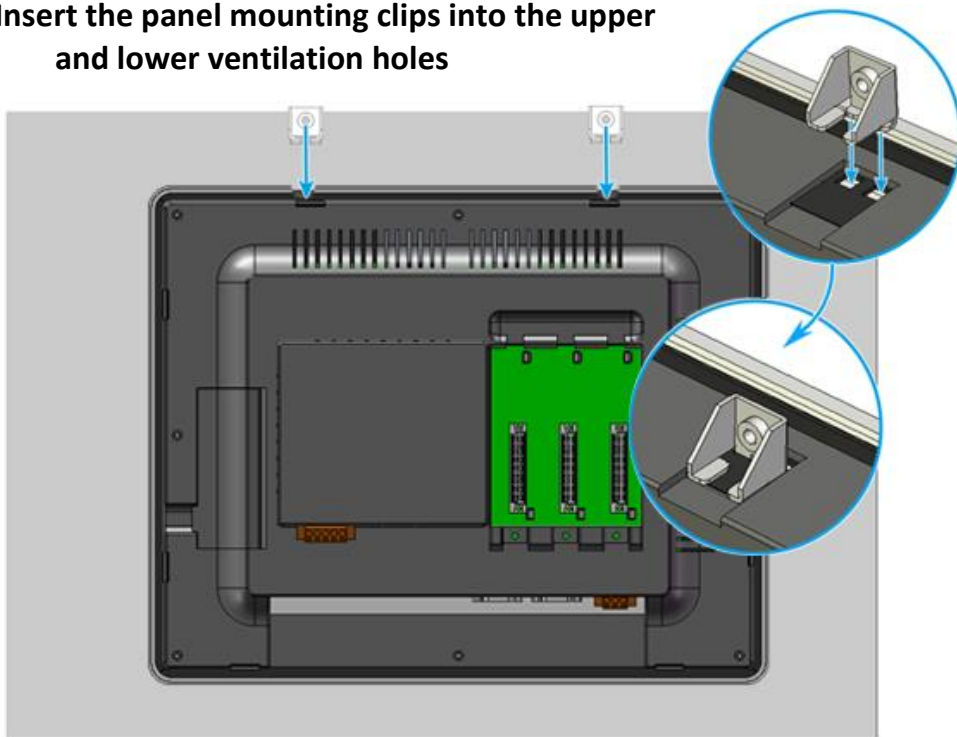

**Step 4: Screw the panel mounting clips to the panel.**

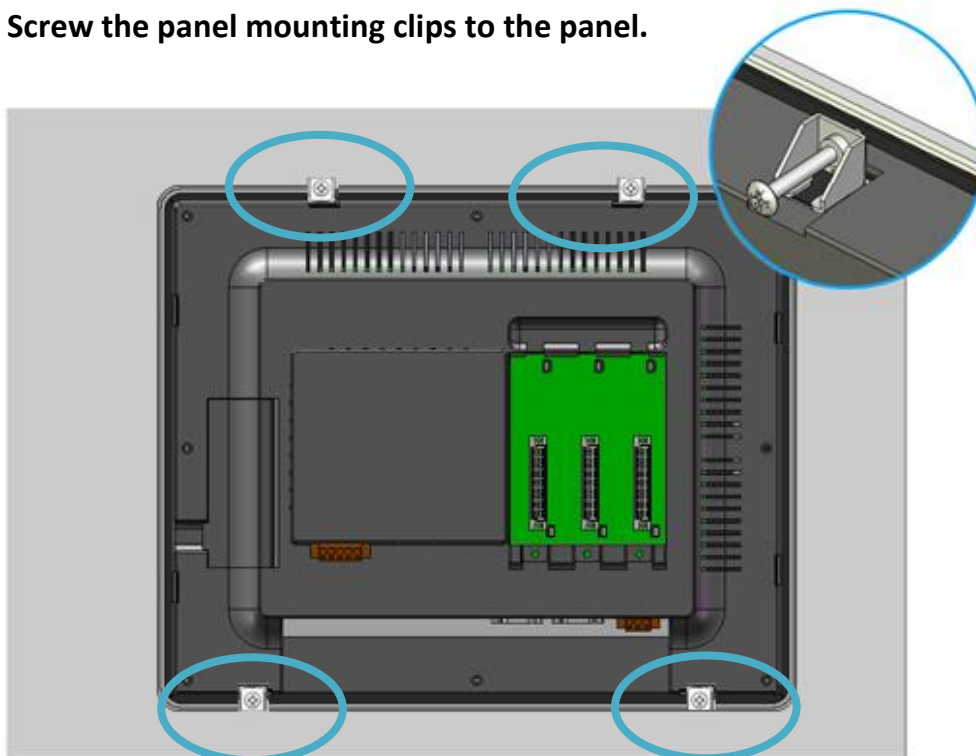

### Tips & Warnings



Recommended Screw Torque: 3.4 ~ 4.5 kgf-cm.

#### 2.1.3.4. Deploying a Basic VP-6231-CE7 System

The VP-6231-CE7 provides a variety of communication interface to suit a range of application. Here is a simple application for using the VP-6231-CE7.

**Step 1: Connect the positive terminal (+) of the power supply to the terminal PWR1/2 and the negative terminal (-) of the power supply to the P.GND**

**Step 2: Connect the USB mouse or the USB keyboard to the USB port**

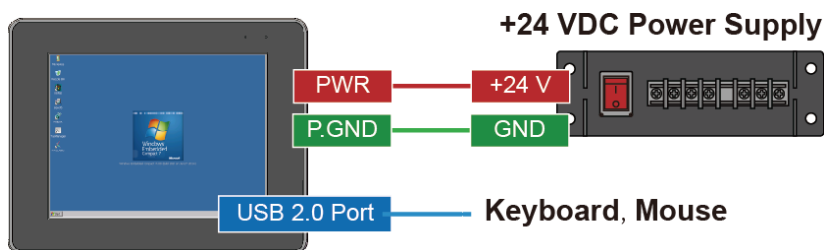

## 2.2. Configuring the Boot Mode

The VP-x231-CE7 has several operating modes, which can be selected by a rotary switch.

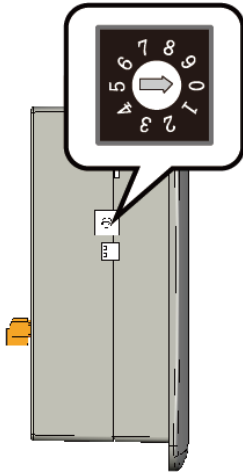

The table below lists the operation modes available with the VP-x231-CE7.

Position	Operating Mode
0	Normal mode (Default)
1	Safe mode
2	Debug mode
3	OS update mode by Ethernet
4	Reserve
5	OS update mode by Micro_SD
6	Reserve (OS Development Mode)
7 ~ 9	User Mode

The following is a brief introduction of these modes.

### Normal Mode (Default mode)

---

Normal mode is the default mode of operation and the one you will use most of the time. Use this mode for more tasks and configurations. Programs also are executed in this mode.

## Safe Mode

---

Safe mode is a trouble shooting. The mode loads the minimum required device drivers and system services to boot the VP-x231-CE7.

If you have malicious software or a program caused the VP-x231-CE7 cannot be boot or run the normal mode, you can boot in safe mode to solve the problem.

## Debug Mode

---

Debug mode is a special environment in which program debug functions can be used in addition to normal system functions.

Debug mode is unsupported.

## OS Update Mode

---

OS update mode is a way used to update OS. For more information on updating the VP-x231-CE7 OS image, please refer to section 6.1. OS updates

## Reserve → OS Development Mode

---

The positions 4, 6, of rotary switch are reserved for OS development.

## User Mode

---

The positions 7, 8, 9 of rotary switch are reserved for user's applications.

When VP-x231-CE7 is boot with one of these positions, it is boot at normal mode.

User's application can check the position of the rotary switch position to run at different mode.

## 2.3. Changing the User Interface Language

The **Regional and Language Settings** is a Windows CE functionality that allows users to change the VP-x231-CE7 user interface with your native language.

**Step 1: Click Start menu, point to Settings, click Control Panel, and then click Regional Settings**

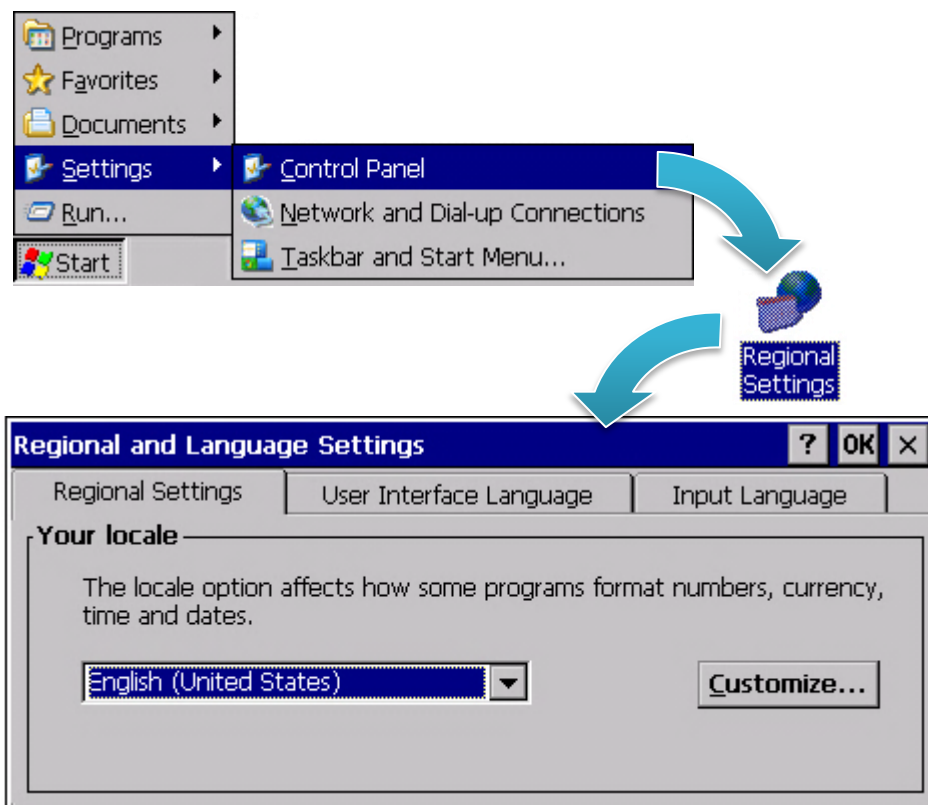

**Step 2: Click User Interface Language tab, choose to your local language, and then click OK button**



**Step 3: Double-click the PAC Utility on the desktop, and then reboot the VP-x231-CE7 for changes to take effect**

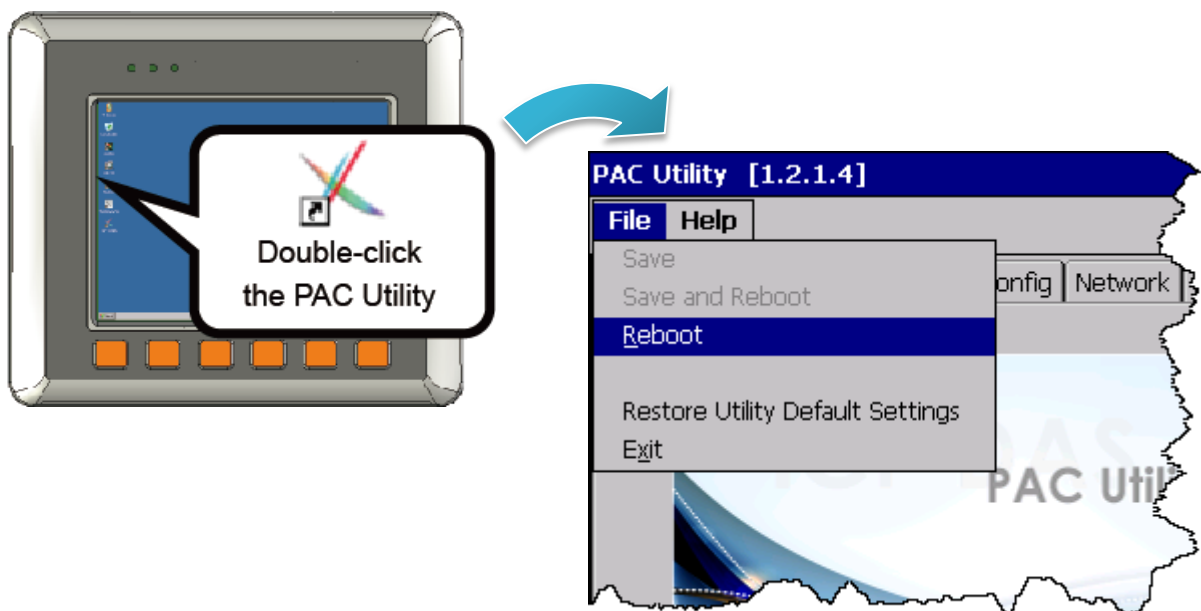

## 2.4. Using PAC Utility to Manage the VP-x231-CE7

The PAC Utility is a collection of the VP-x231-CE7 system tool that allows users to manage and configure the VP-x231-CE7 quickly and easily.

For more detailed information on PAC Utility applications, please refer to “3.1. PAC Utility”

**Step 1: Double-click the PAC Utility on the desktop**

**Step 2: Configure IP address (DHCP), FTP Server, Auto Execution files..., etc**

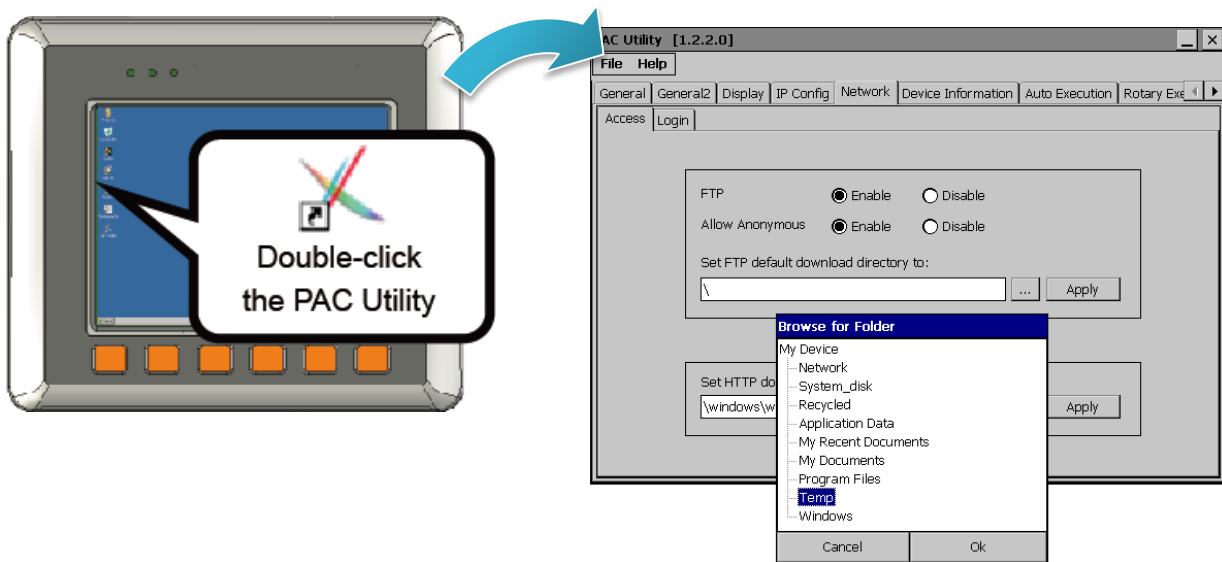

**Step 3: Reboot the VP-x231-CE7**

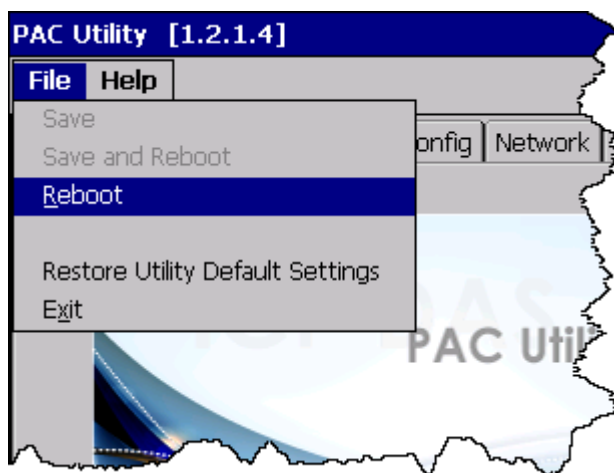



## 2.5. Using DCON Utility Pro Configure I/O Modules

DCON Utility Pro allows users to configure and manage the I/O modules via Ethernet or serial ports (RS-232/RS-485).

**Step 1: Double-click the DCON\_Utility\_Pro on the desktop**

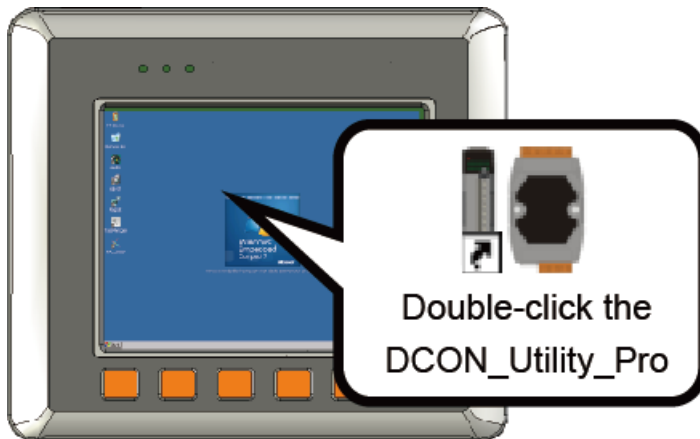

**Step 2: Click the  button**

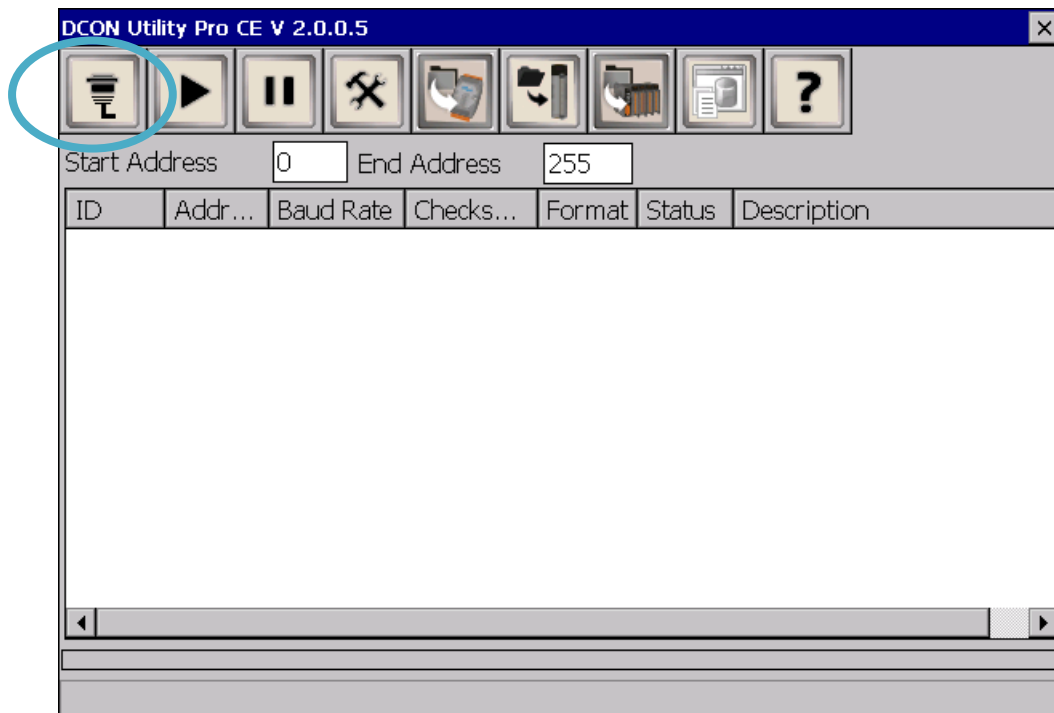

### Step 3: Configure the communication settings

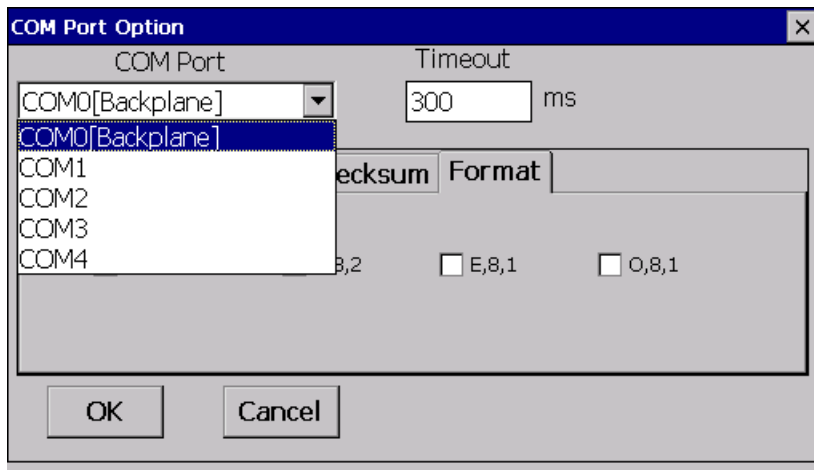

#### Tips & Warnings



The COM port settings for expansion I/O modules are listed below.

COM0 [Backplane]

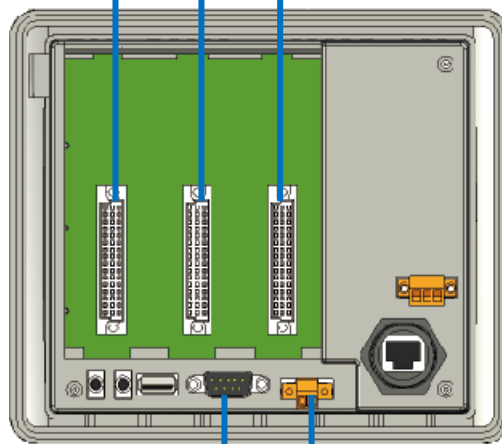

COM2/3

For more information on these COM port selections, please refer to the specification of the pin assignments in section 1.3. Overview

Step 4: Click the  button

Step 5: Click the module name to configure the I/O module

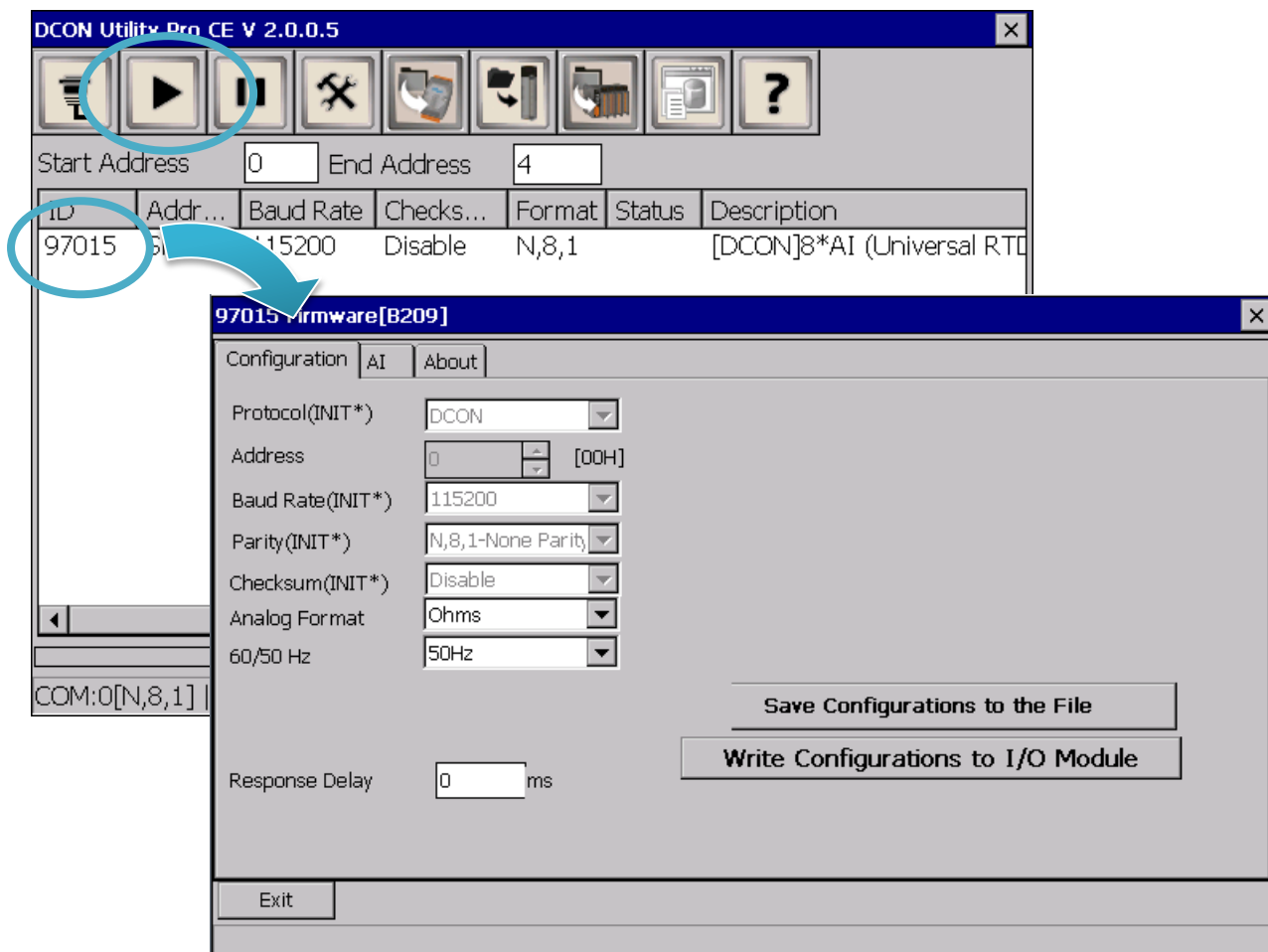

### 3. Tools and Tasks

This chapter provides a brief introduction of the VP-x231-CE7 service tools and its benefits.

There are several tools and utilities built-in and designed for use with VP-x231-CE7. Some of these are pre-installed on VP-x231-CE7 and can work directly on VP-x231-CE7, and some of these are supporting tools and can help you to manage the VP-x231-CE7 remotely on a PC.

The following tools are pre-installed on VP-x231-CE7 and can work directly on VP-x231-CE7 that can be found on the CD that was provided with the package or by downloading the latest version from ICP DAS web site.

CD:\vp-x231\System\_Disk\Tools\

[http://ftp.icpdas.com/pub/cd/winpac\\_am335x/vp-x231/system\\_disk/tools/](http://ftp.icpdas.com/pub/cd/winpac_am335x/vp-x231/system_disk/tools/)

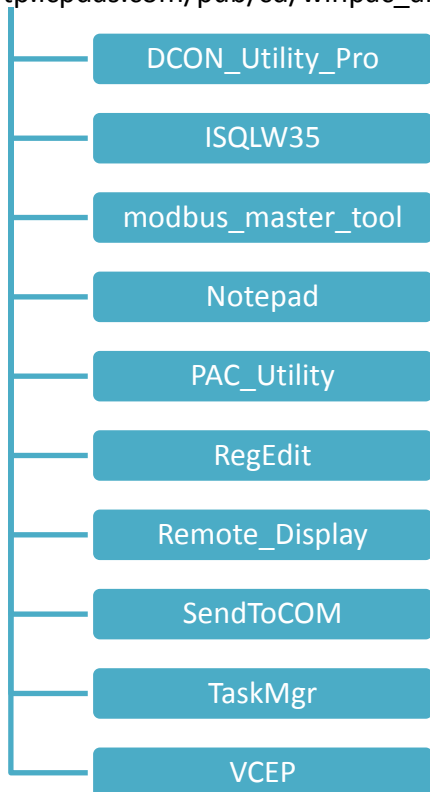

### 3.1. PAC Utility

PAC Utility is a collection of software applications that enable management and configuration of VP-x231-CE7 system and features.

PAC Utility is subject to change

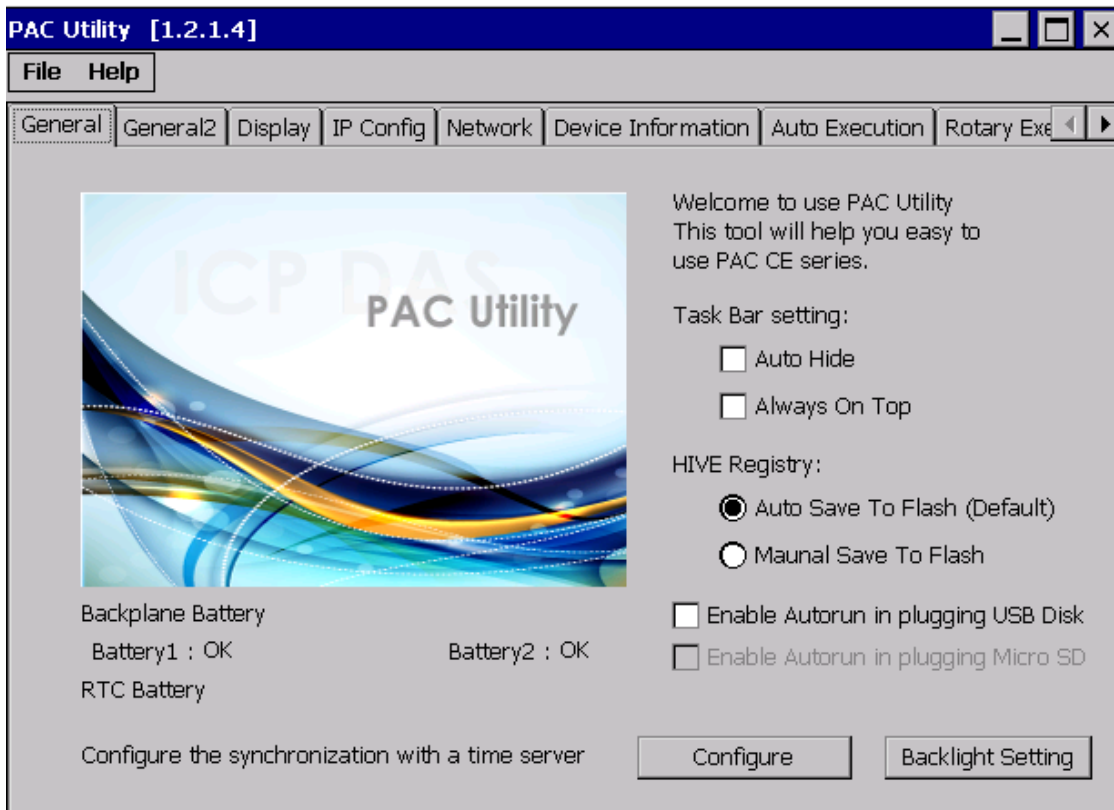

The PAC Utility includes the following menu bars and property tabs.

All of these functions will be explained later.

Menu bar	Property Tab
File	General
Help	General2
	Display
	IP Config
	Network
	Device Information
	Auto Execution
	Rotary Execution

### 3.1.1. Menu Bar – File

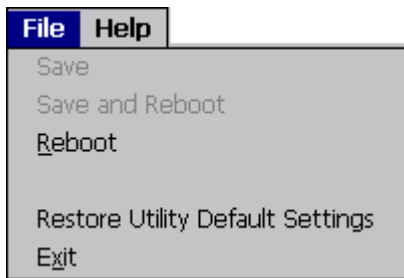

The menus use to	How to use
Reboot	Restarts the VP-x231-CE7
Restore Default Settings	Restore the VP-x231-CE7 settings to its default.
Exit	Exits the PAC Utility.

### 3.1.2. Menu Bar – Help

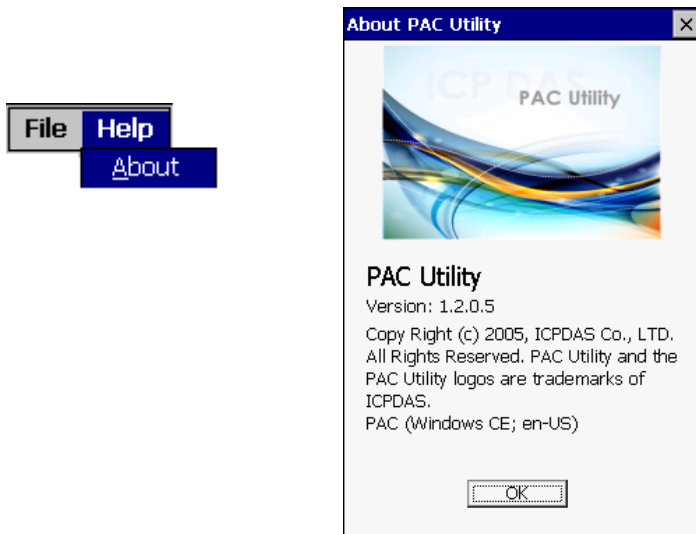

The menus use to	How to use
About	Displays a dialog box with information about PAC Utility, including the current version and copyright information.

### 3.1.3. Property Tab - General

The **General** tab provides functions to configure the task bar, check the status of the battery..., etc.

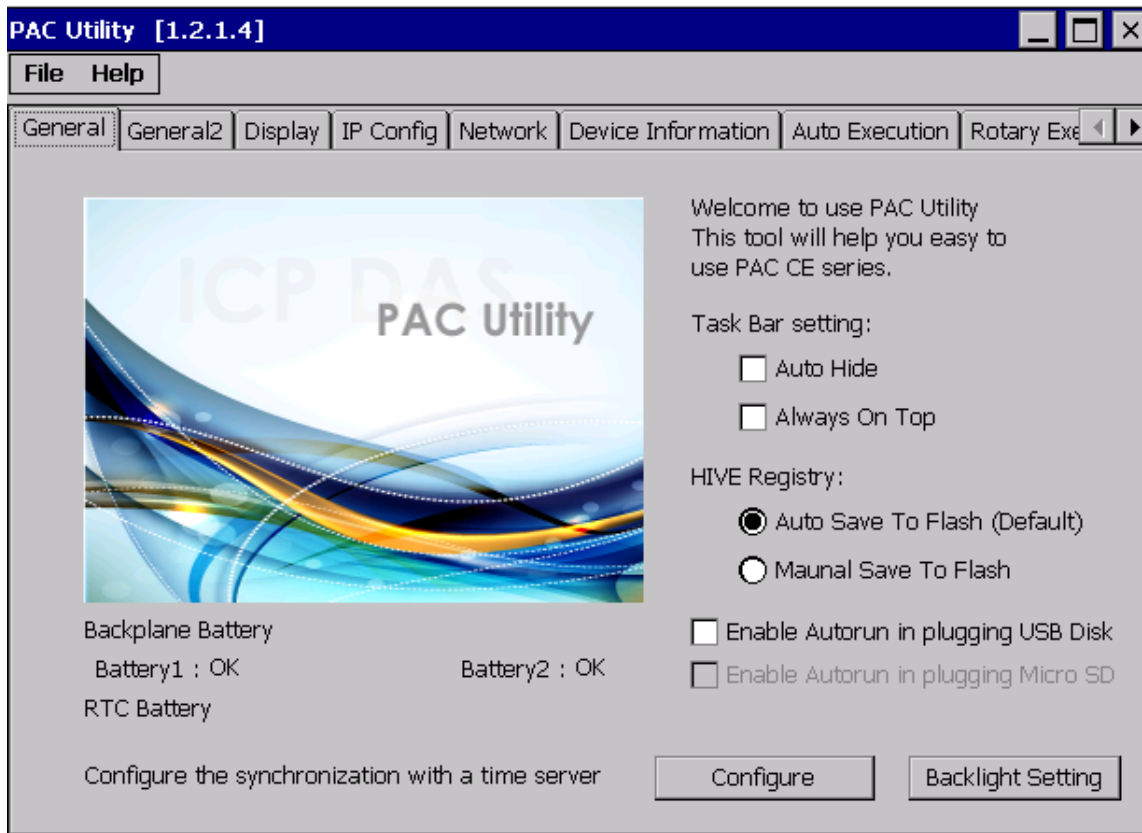

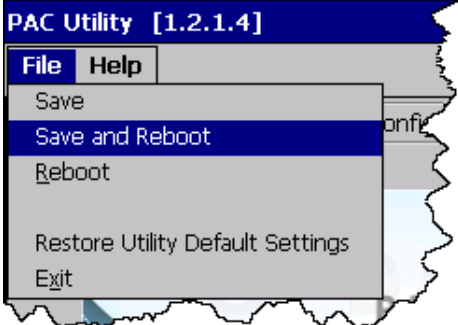
The tab use to	How to use
Lock or Auto-Hide the taskbar	<p><b>Auto-Hide the taskbar:</b> Select the <b>Auto Hide</b> check box.</p> <p><b>Lock the taskbar:</b> Select the <b>Always On Top</b> check box.</p>
Auto save or manual save to flash	<p><b>Auto save to flash:</b> Select the <b>Auto Save To Flash (Default)</b> check box. Any changes made to the VP-x231-CE7 will be saved and only take effect after the VP-x231-CE7 reboots.</p> <p><b>Manual save to flash:</b> Select the <b>Manual Save to Flash</b> check box. Any changes made to the VP-x231-CE7 will be saved by clicking the Save and Reboot from File menu.</p> 

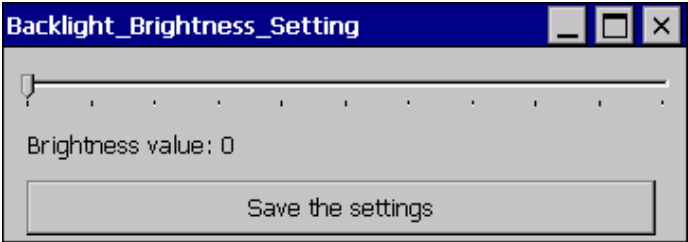

The tab use to	How to use
Enable USB autorun	Select the <b>Enable Autorun in plugging USB Disk</b> check box.
Enable microSD auotrun	This item is temporarily unavailable.
Automatic synchronization of system time	Refer to the Appendix A.2. How to configure the service for automatically synchronizing with the internet time server.
Adjust the backlight	<p>Move the slider to the left to decrease the brightness or move the slider to the right to increase the brightness, and then click the <b>Save the settings</b> button.</p> 

### 3.1.4. Property Tab – General2

The **General2** tab provides functions to specify the name of the USB disk.



The tab use to	How to use
Specify the name of the USB disk	Enter a name in the <b>USB Hard Disk:</b> field

### 3.1.5. Property Tab – Display

The **Display** tab provides functions to configure the monitor settings.

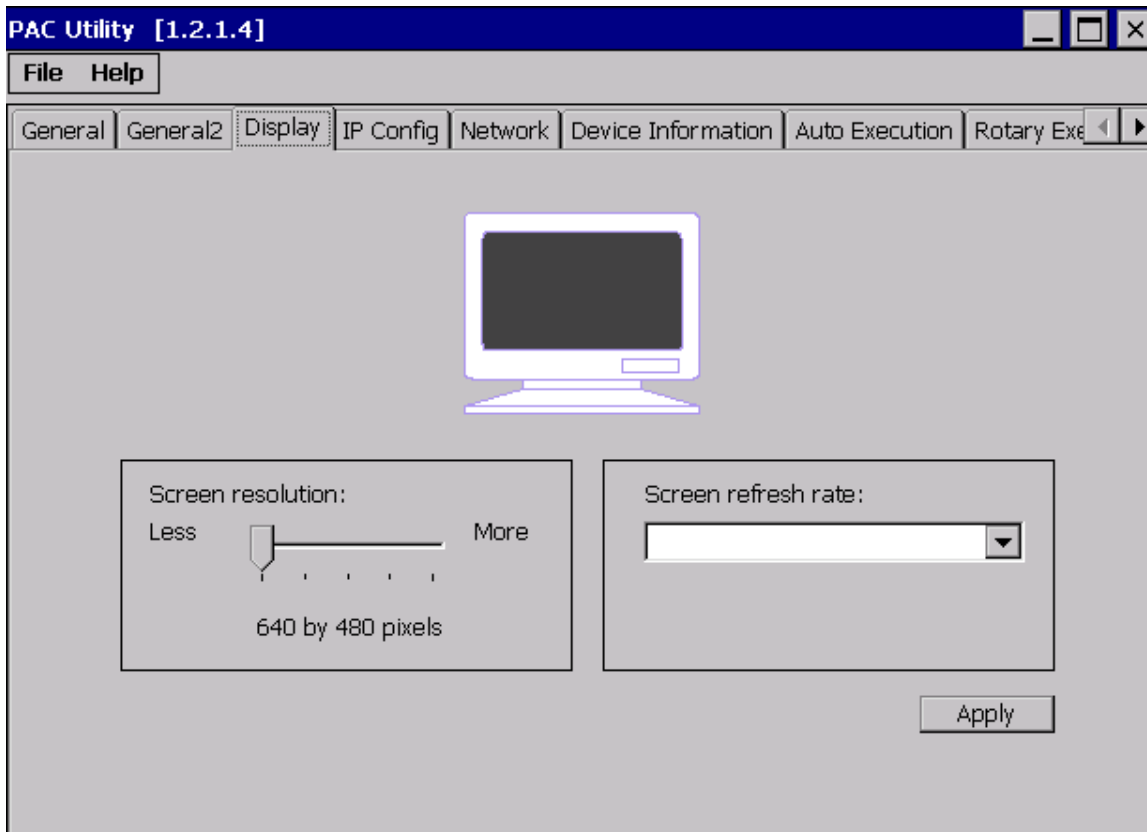

The tab use to	How to use
Adjust the screen resolution	Move the slider to the left to decrease the resolution or move the slider to the right to increase the resolution, and then click the <b>Apply</b> button.
Change the screen refresh rate	Select the desired refresh rate from the <b>Screen refresh rate</b> drop-down list, and then click the <b>Apply</b> button.

### 3.1.6. Property Tab – IP Config

The **IP Config** tab provides functions to configure either DHCP (Roaming) or manually configured (Static) network settings and to monitor the MAC address. Generally, DHCP is the default settings, but if you don't have a DHCP server, you must configure the network settings by using manual configuration.

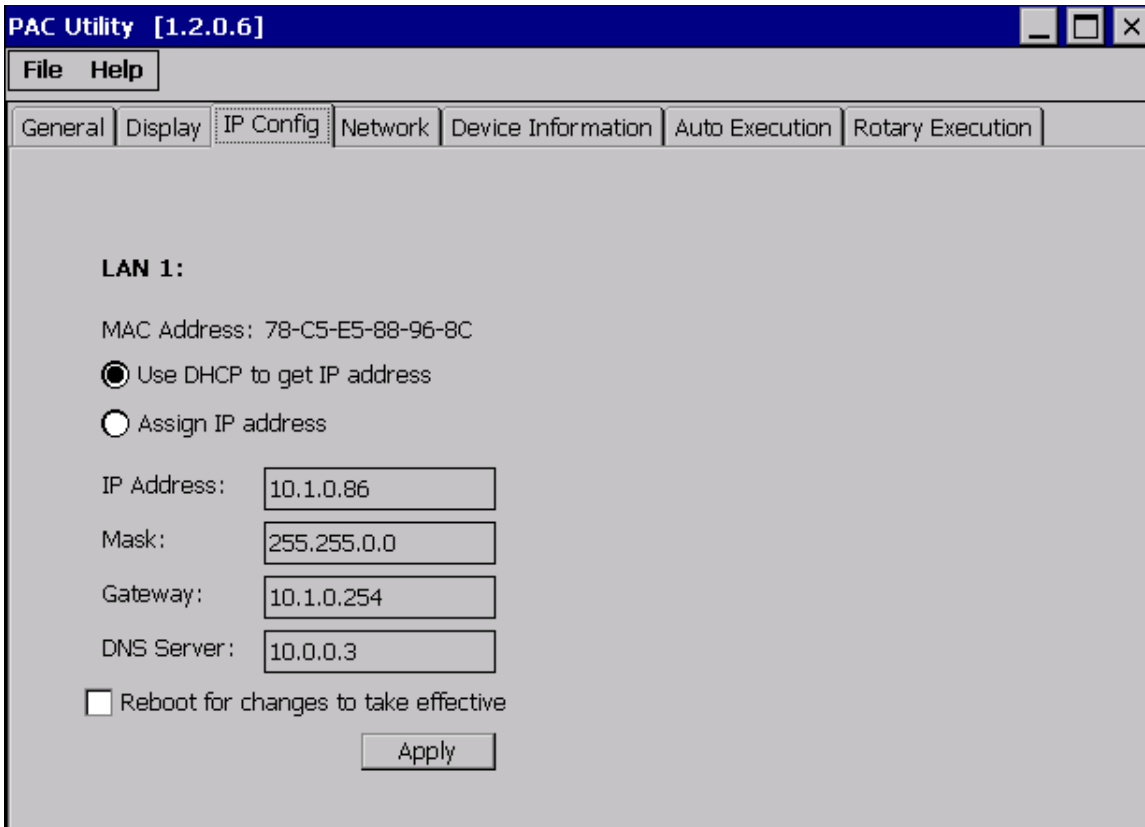

The tab use to	How to use
Set the network settings	<b>Use DHCP to get IP address:</b> Select the <b>Use DHCP to get IP address</b> option, and then click the <b>Apply</b> button. <b>Assign an IP address:</b> Select the <b>Assign IP address</b> option, and then click the <b>Apply</b> button.

### 3.1.7. Property Tab – Network

The **Network** tab comprises three tabs – Access, Login and File Server Settings.

#### Access

The **Access** tab provides functions to enable/disable the FTP access, enable/disable anonymous FTP access, and configure the FTP and HTTP directory path.

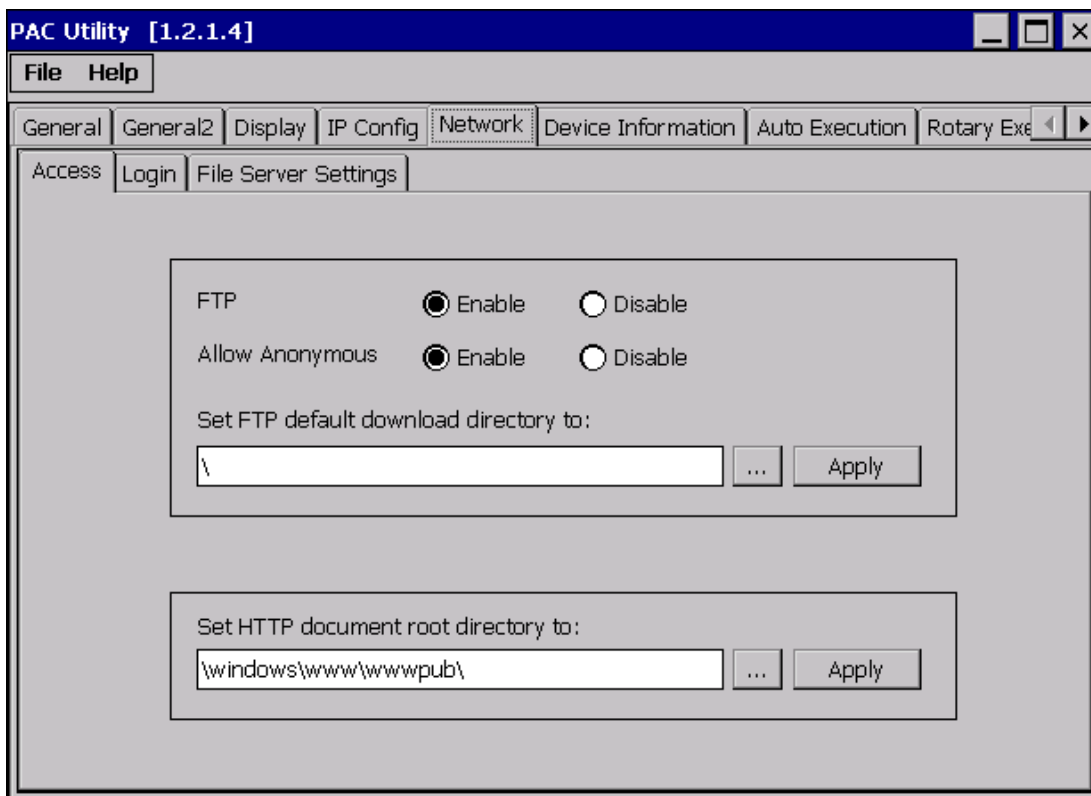

The tab use to	How to use
Enable or disable the FTP access	<p><b>Enable the FTP access:</b> Select the <b>Enable</b> check box in the <b>FTP</b> field, and then click the <b>Apply</b> button.</p> <p><b>Disable the FTP access:</b> Select the <b>Disable</b> check box in the <b>FTP</b> field, and then click the <b>Apply</b> button.</p>

The tab use to	How to use
Enable or disable anonymous FTP access	<p><b>Enable anonymous FTP access:</b> Select the <b>Enable</b> check box in the <b>Allow Anonymous</b> field, and then click the <b>Apply</b> button.</p> <p><b>Disable anonymous FTP access:</b> Select the <b>Disable</b> check box in the <b>Allow Anonymous</b> field, and then click the <b>Apply</b> button.</p>
Set the FTP directory path	Enter a new path in the <b>Set FTP default download directory to:</b> field, and then click the <b>Apply</b> button.
Set the HTTP directory path	Enter a new path in the <b>Set HTTP document root directory to:</b> field, and then click the <b>Apply</b> button.

## Login

The **Login** tab provides functions to maintain the FTP accounts.

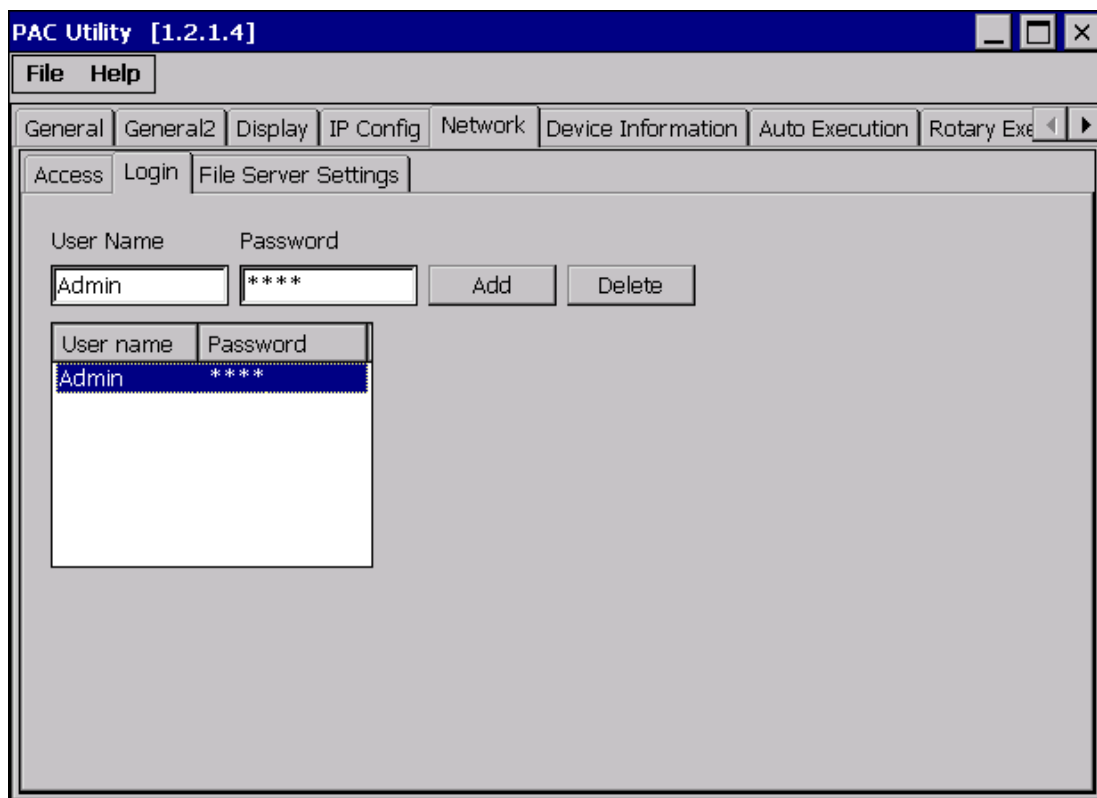

The tab use to	How to use
Maintain the FTP accounts	Refer to the Appendix C.1 How to add a user account to remote login the VP-x231-CE7 from PC.

## File Server Settings

The **File Server Settings** tab provides functions to set the SMB server.

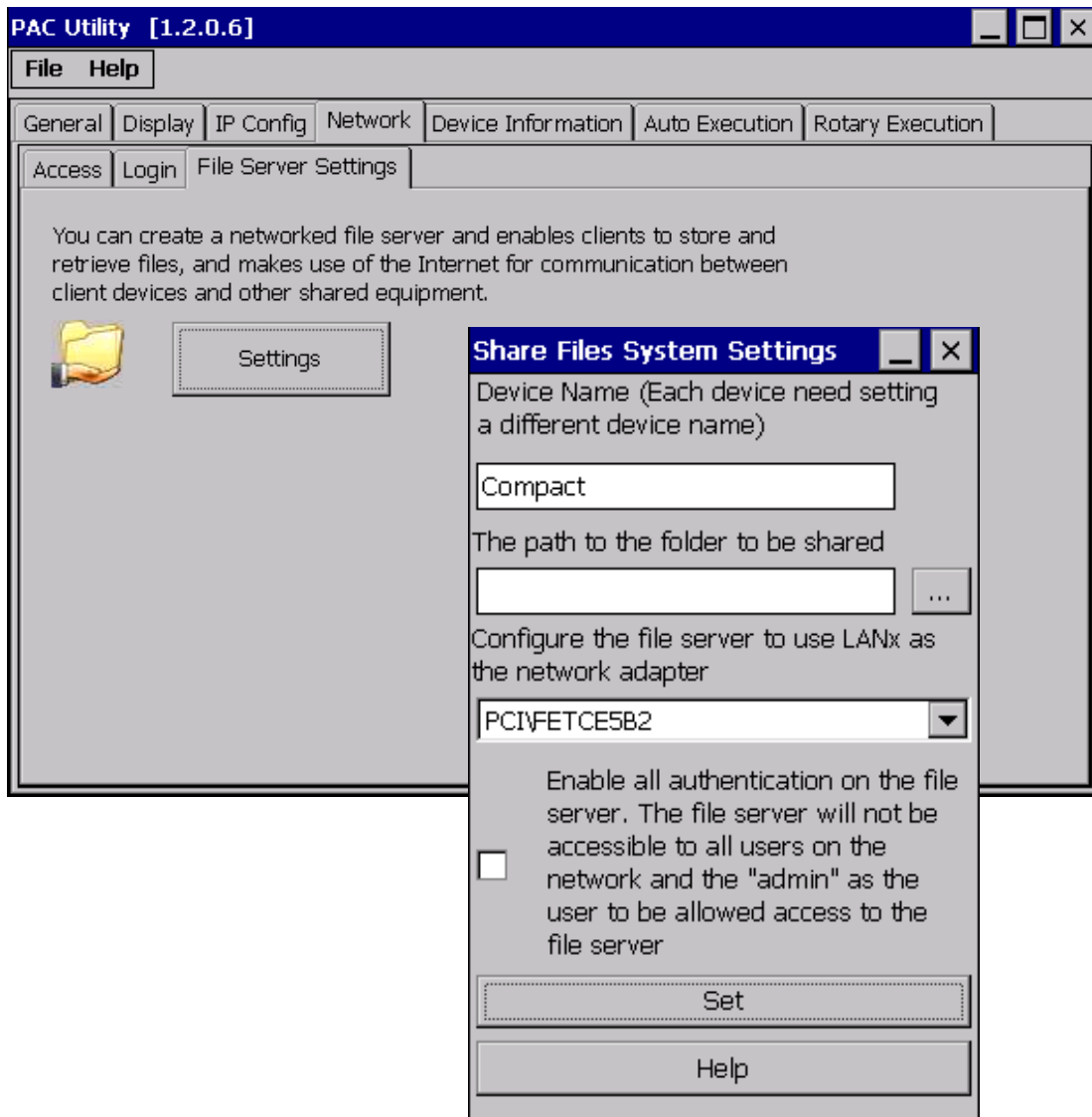

The tab use to	How to use
Set the SMB server	Click the Settings button to set the SMB server path.

### 3.1.8. Property Tab – Device Information

The **Device Information** tab provides functions to monitor necessary system information of the VP-x231-CE7. The information is the most important note of version control for upgrading system.

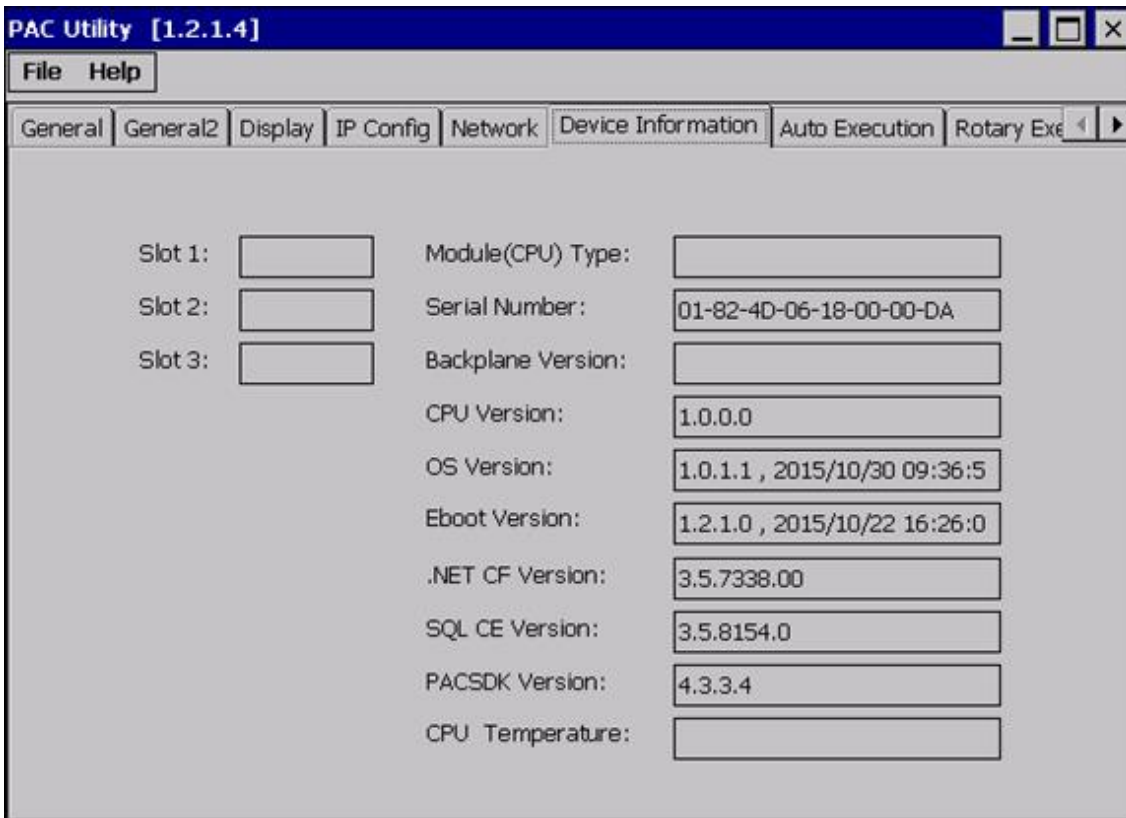



### 3.1.9. Property Tab – Auto Execution

The **Auto Execution** tab provides functions to configure programs running at VP-x231-CE7 startup, it allows users to configure ten execute files at most.

#### Tips & Warnings



The specific extensions are .exe and .bat, and they are executed in order of program 1, program 2, etc.

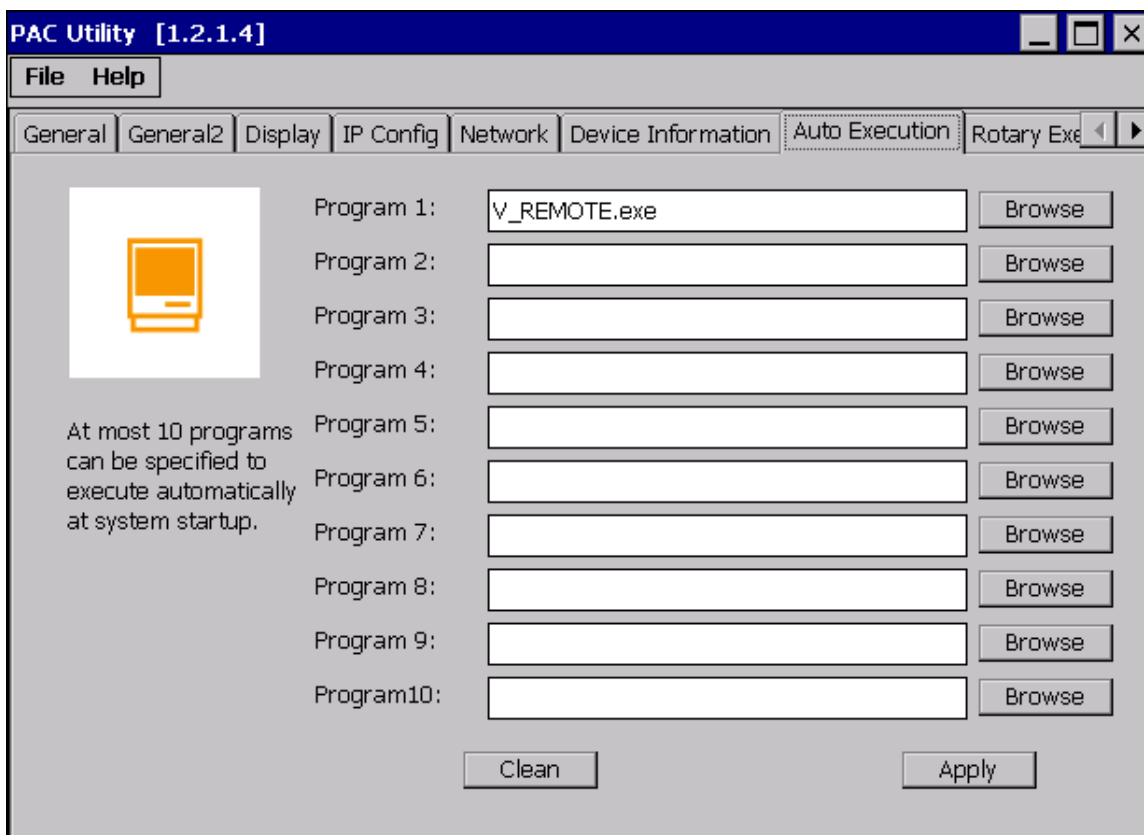

The tab use to	How to use
Configure programs running at startup	Click the <b>Browse</b> button to select the execute file which you want, and then click the <b>Apply</b> button.

### 3.1.10. Property Tab – Rotary Execution

The **Rotary Execution** tab provides functions to configure programs running at VP-x231-CE7 startup in one of the user defined mode, it allows users to configure ten execute files at most.

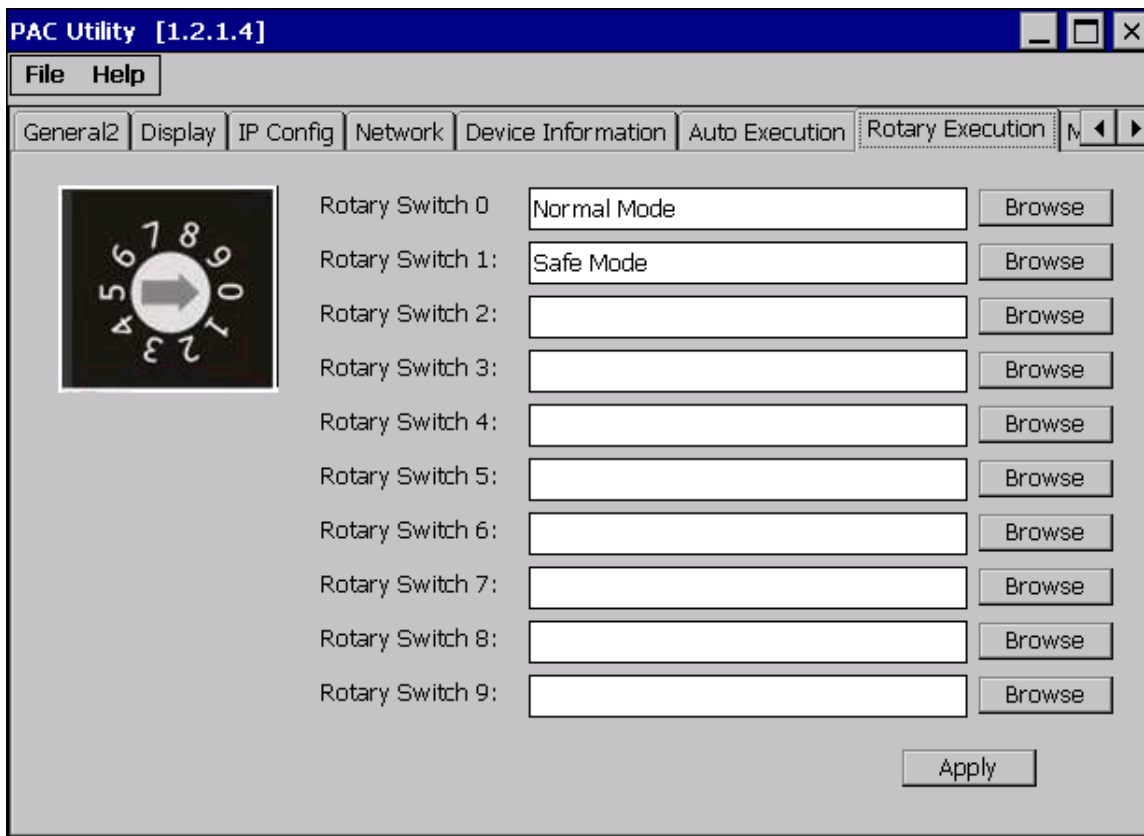

The tab use to	How to use
Configure programs running at startup in one of the user defined mode	Click the <b>Browse</b> button to select the execute file which you want, and then click the <b>Apply</b> button.

## 3.2. DCON Utility Pro

DCON Utility Pro enables users easily to configure and manage the I/O modules via Ethernet or serial ports (RS-232/RS-485).

For more information on how to use DCON Utility Pro to configure I/O modules, please refer to 2.5. Using DCON Utility Pro to Configure I/O Modules

For more detailed information on DCON Utility application, please refer to:

[http://www.icpdas.com/root/product/solutions/software/utilities/dcon\\_utility\\_pro.html](http://www.icpdas.com/root/product/solutions/software/utilities/dcon_utility_pro.html)

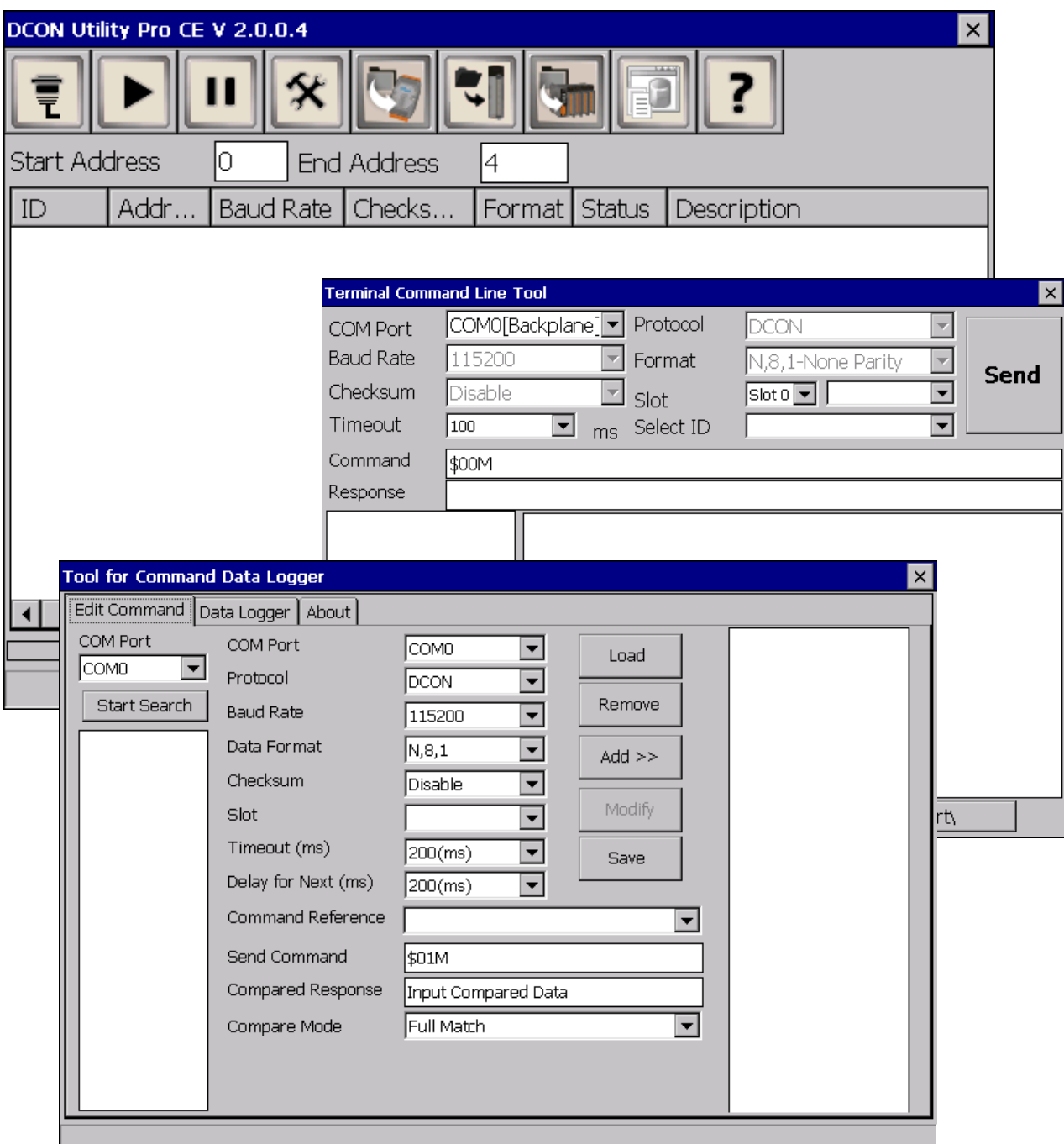

### 3.3. TaskMgr

The TaskMgr is a Windows CE application, which provides real time info on all processes and threads including System threads, similar in appearance to the Windows Task Manager.

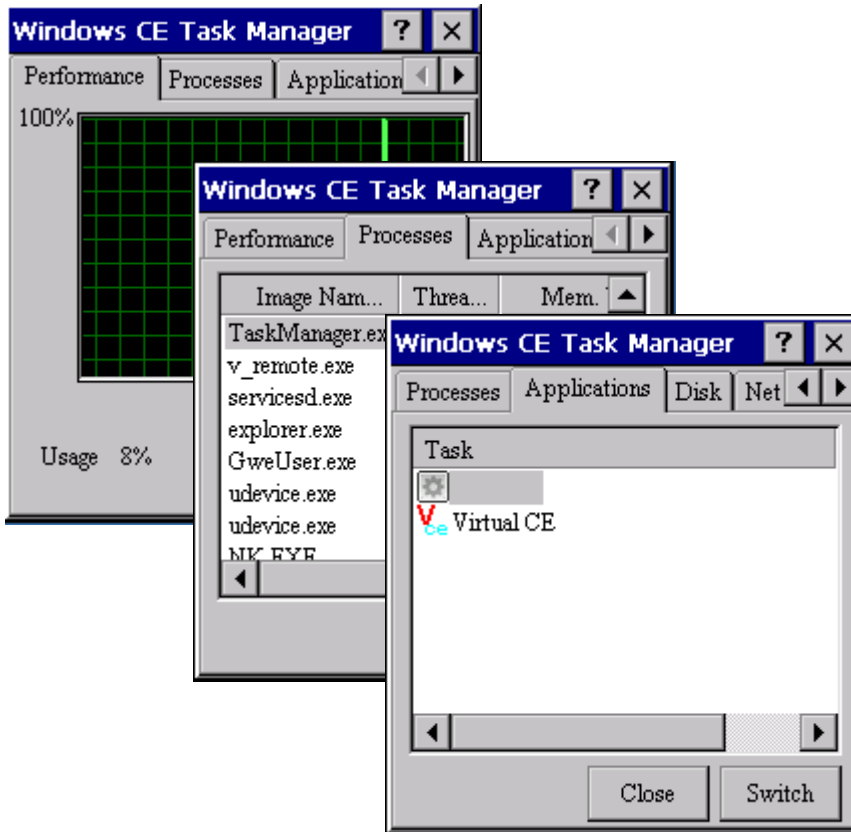

### 3.4. VCEP

ICP DAS VCEP is designed for managing your VP-x231-CE7 anywhere. No matter where you are, ICP DAS VCEP provides a convenient environment on the Desktop PC and lets you control your VP-x231-CE7 remotely.

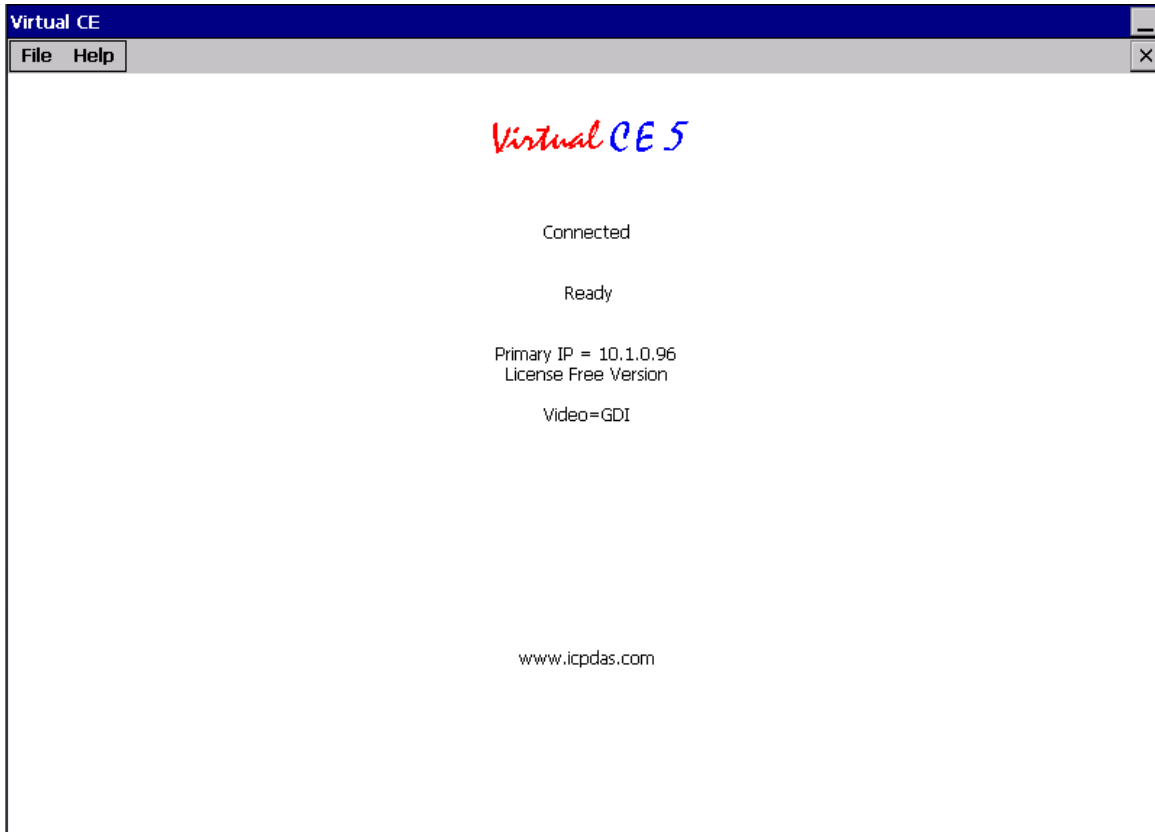

ICP DAS VCEP is composed of two main components: The **Server** which runs on VP-x231-CE7 and the **Client** which runs on a Desktop PC.

Once a connection is established between the client and server (initiated by the client), the client will periodically send requests for screen updates and send mouse/key click information to the server to simulate.

Each video frame is inter-compressed against the previous frame and then intra-compressed with a modified LZW scheme to minimize the amount of data transmitted from server to client.

For more detailed information on VCEP application, please refer to [http://ftp.icpdas.com.tw/pub/cd/winpac\\_am335x/VP-x231-CE7/pc\\_tools/vcep/](http://ftp.icpdas.com.tw/pub/cd/winpac_am335x/VP-x231-CE7/pc_tools/vcep/)

### 3.5. Remote\_Display

The **Remote Display** allows VP-x231-CE7 to be controlled and monitored from a remote location.

This tool is composed of two parts, a client and a server. The server is a program named cerdisp.exe running on VP-x231-CE7. The client is a PC-based program named cerhost.exe running on the PC.



cerdisp



cerhost

Once a connection is established between the client and server (initiated by the client), the client will periodically send requests for screen updates and send mouse/key click information to the server to simulate.

### 3.6. SendToCOM

The **SendToCOM** uses the serial port to communicate with expansion module. To use the SendToCOM, you can send data to expansion module through the serial port, and receive data from other device through the serial port.

For more information about these commands for communicating with expansion module, please refer to:

[http://www.icpdas.com/root/product/solutions/remote\\_io/rs-485/i-8k\\_i-87k/i-8k\\_i-87k\\_selection.html#b](http://www.icpdas.com/root/product/solutions/remote_io/rs-485/i-8k_i-87k/i-8k_i-87k_selection.html#b)

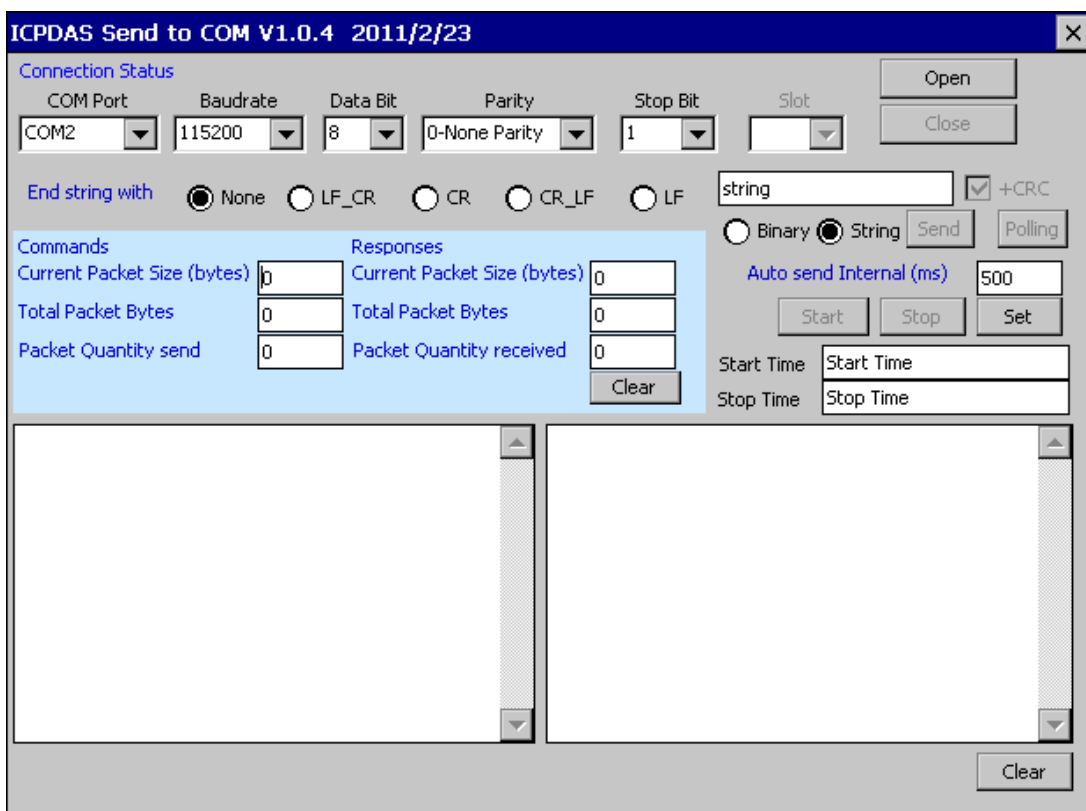

### 3.7. RegEdit

The **RegEdit** provides a hierarchical representation of the registry on a target computer, similar in appearance to the Windows Registry Editor. The standard registry roots are represented; you can add keys beneath a root to point to existing registry keys, or you can add your own keys. Values can be changed for existing keys, or added for new keys, and default keys can be specified. For more information, see Registry Settings Management in Deployment.

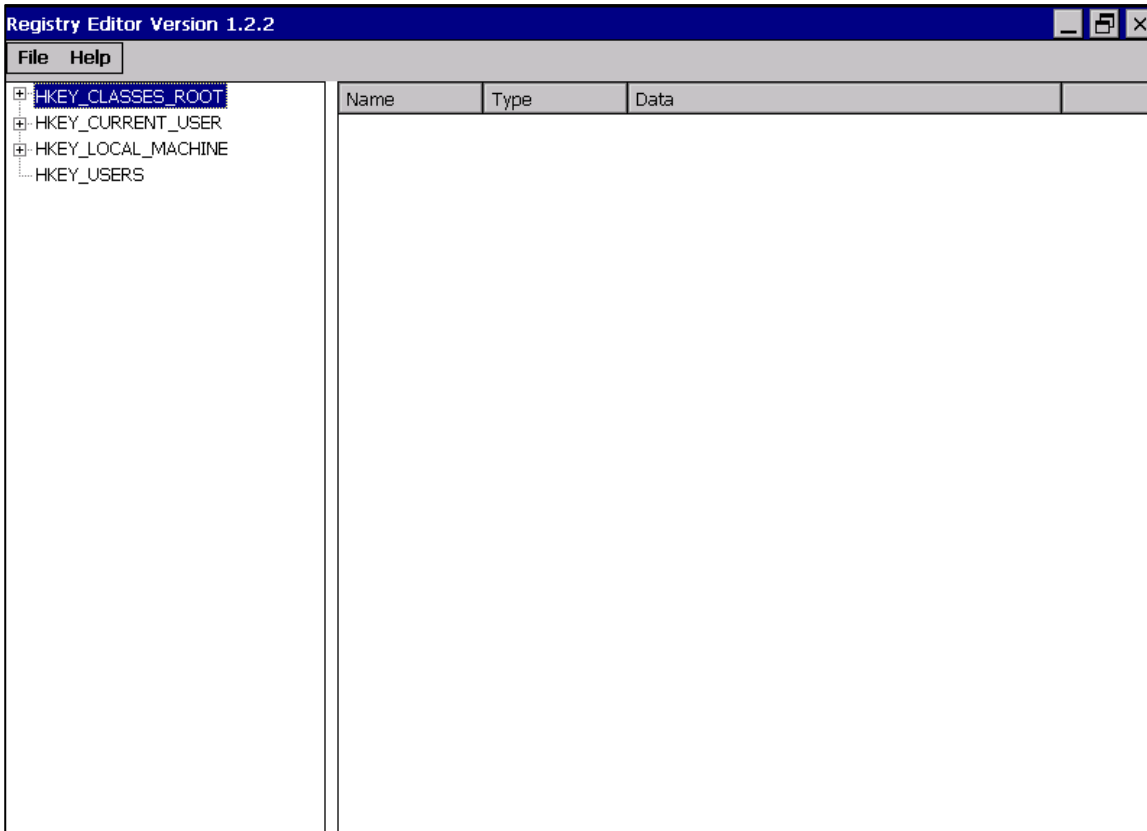



### 3.8. ISQLW35

The **ISQLW35** is a Windows Embedded Compact 7 functionality that implements SQL Server Compact 3.5 Query.

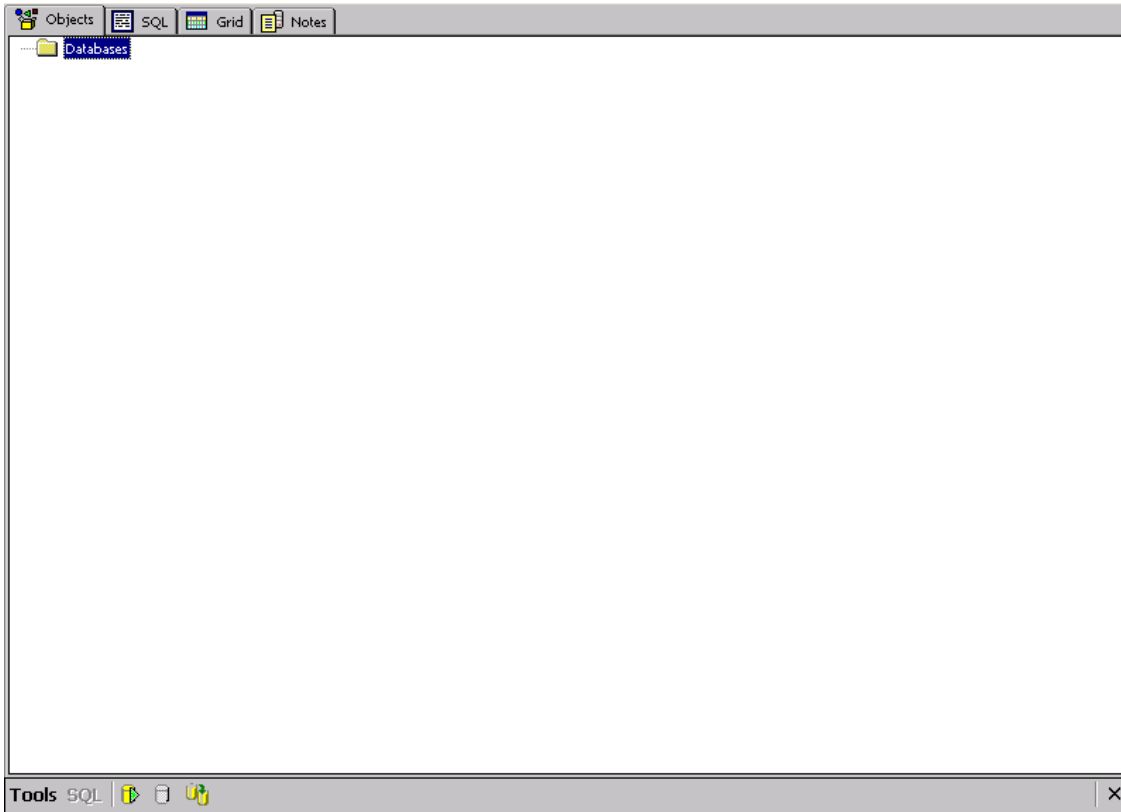

### 3.9. INotepad

The **INotepad** is a common text-only editor. The resulting files have no format tags or styles.

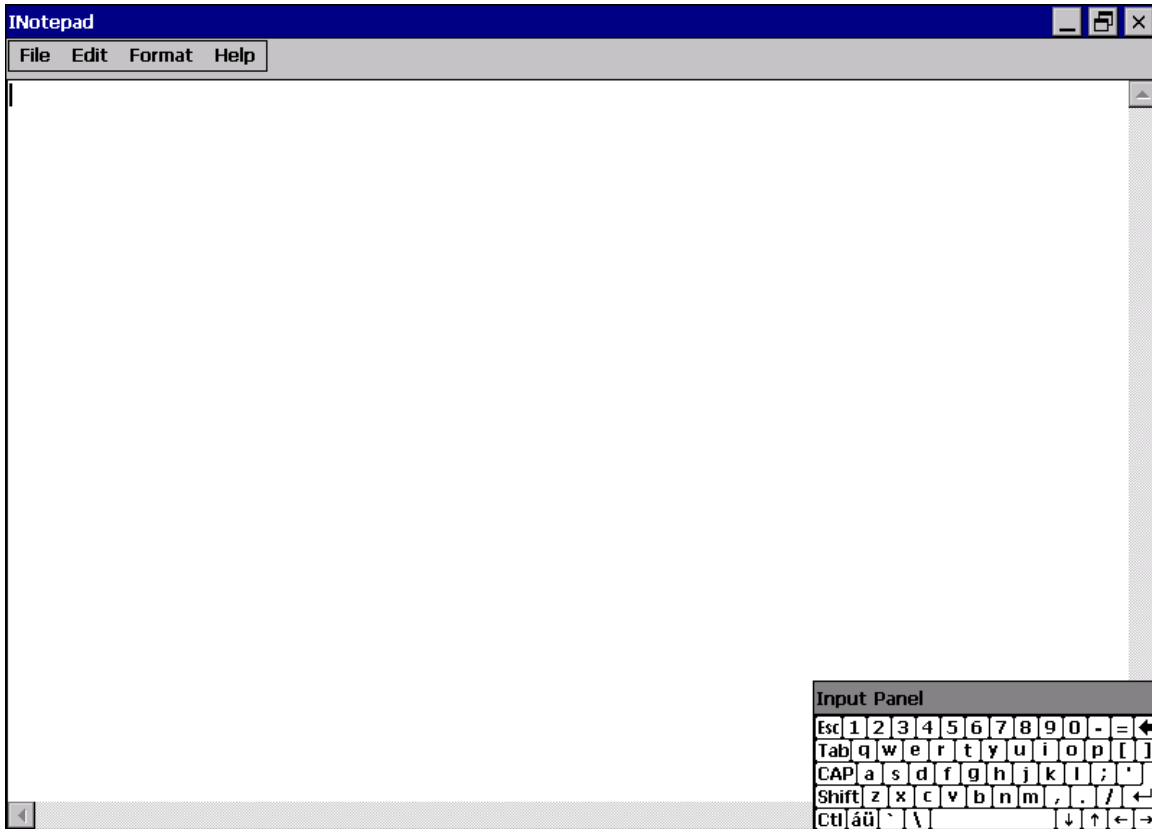

## 4. Your First VP-x231-CE7 Program

This chapter provides a guided tour that describes the steps needed to set-up a development environment, download, install, configure for user programming with VP-x231-CE7 modules.

### 4.1. Setting up the Development Environment

Before writing your first program, ensure that you have the necessary development tool and the corresponding SDKs are installed on your system.

### 4.1.1. Preparing the Development Tools and Programming Languages

VP-x231-CE7 is a Windows CE-based device that supports three programming languages for developing Windows CE applications.

- Visual Basic.NET
- Visual C#
- Visual C++

#### Development Tools

VP-x231-CE7 supports the application development with the Professional Edition application of Visual Studio 2008.



---

#### Tips & Warnings



There are some updates for Visual Studio 2008 to provide support for Windows Embedded Compact 7.

If you have Professional Edition of Visual Studio 2008 are installed, make sure all of the following package are installed

**1. Visual Studio 2008 Service Pack 1**

<http://www.microsoft.com/en-us/download/details.aspx?id=10986>

**2. Visual Studio 2008 update for Windows Embedded Compact 7**

<http://www.microsoft.com/en-us/download/confirmation.aspx?id=11935>

**3. Windows Embedded Compact 7 ATL Update for Visual Studio 2008 SP1**

<http://support.microsoft.com/kb/2468183/en-us>

---

## 4.1.2. Installing the VP-x231-CE7 SDK

The VP-x231-CE7 SDK offers several APIs for customizing the standard features and integrating with other applications, devices and services.

### Step 1: Get the latest version of the VP-x231-CE7 SDK, AM335x\_WINCE7\_SDKV100B03

The VP-x231-CE7 SDK can be found from the CD that was provided with the package or by downloading the latest version from ICP DAS web site.

CD:\VP-x231\SDK\PlatformSDK\

[http://ftp.icpdas.com/pub/cd/winpac\\_am335x/vp-x231/sdk/platformsdk/](http://ftp.icpdas.com/pub/cd/winpac_am335x/vp-x231/sdk/platformsdk/)

### Step 2: Execute the AM335x\_WINCE7\_SDK\_YYYYMMDD.msi

Follow the prompts until the installation process is complete.

### Step 3: Execute the VisualStudioDeviceWindowsEmbeddedCompact7

Follow the prompts until the installation process is complete.

## 4.2. First VP-x231-CE7 Program in VB.NET

The best way to learn programming with VP-x231-CE7 is to actually create a VP-x231-CE7 program.

The example below demonstrates how to create a demo program running on VP-x231-CE7 with VB.NET.

To create a demo program with VB.NET that includes the following main steps:

1. Create a new project
2. Specify the path of the PAC reference
3. Add the control to the form
4. Add the event handling for the control
5. Upload the application to VP-x231-CE7
6. Execute the application on VP-x231-CE7

All main steps will be described in the following subsection.

In this tutorial, we will assume that you have installed VP-x231-CE7 SDK on PC and used the Visual Studio 2008 for application development.

### 4.2.1. Create a new project

The Visual VB.net project template is a composite control that you use in this example creates a new project with this user control.

#### Step 1: Start Visual Studio 2008



#### Step 2: On the File menu, point to New, and then click Project

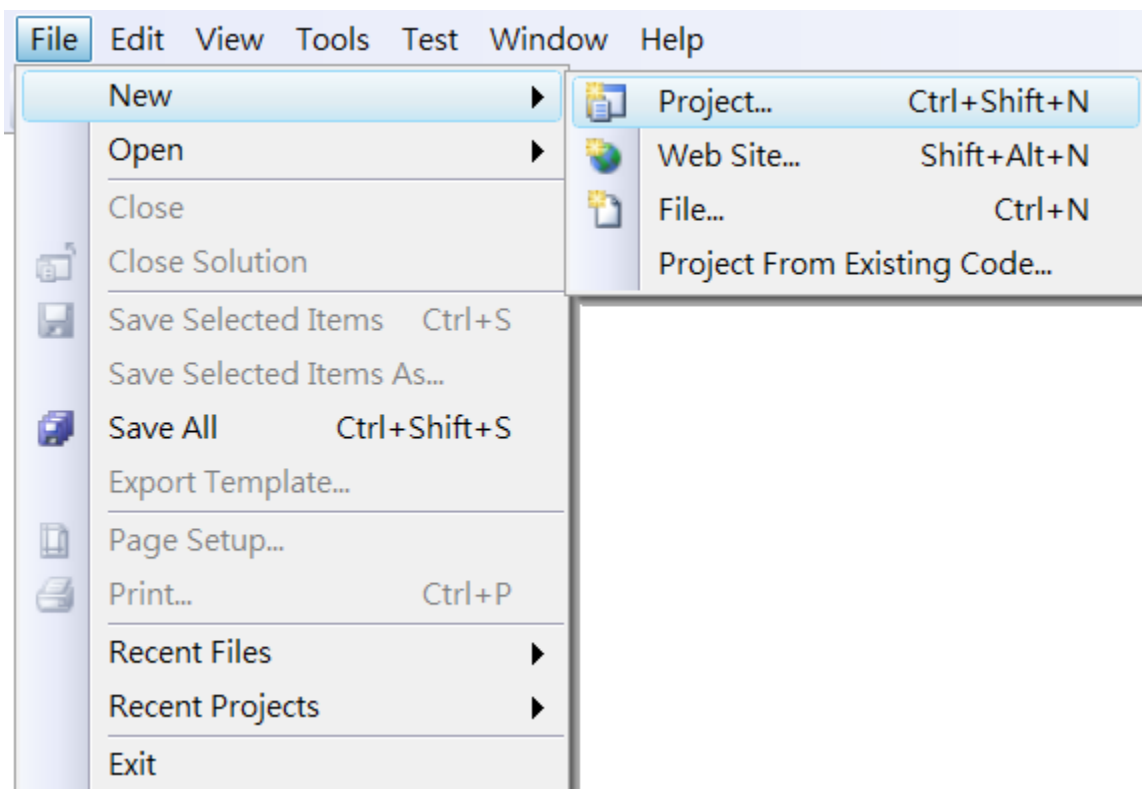

**Step 3: In the Project types pane, expand Visual Basic node and select Smart Device**

**Step 4: In the list of Templates, select Smart Device Project**

**Step 5: Specify a name and a location for the application and then click OK**

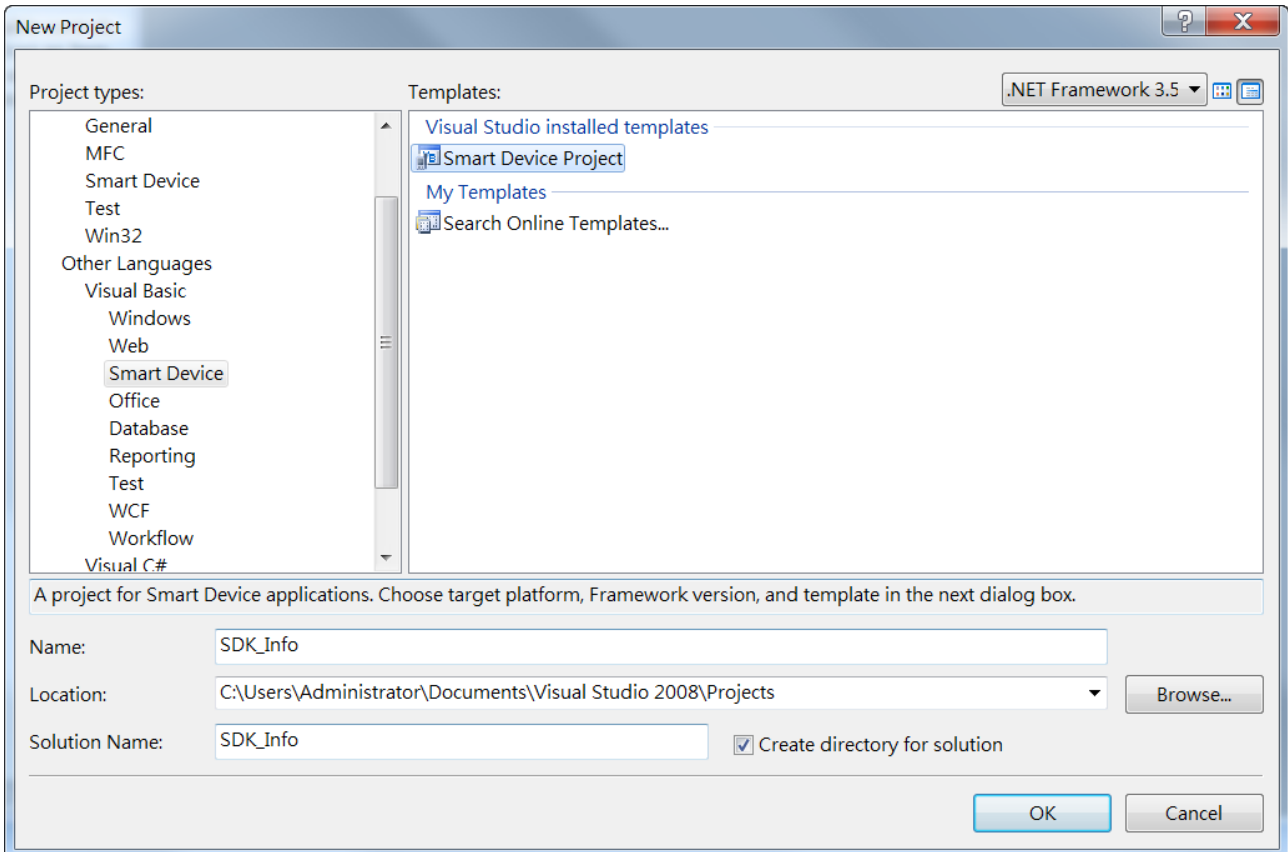



**Step 6: In the Target platform, select Windows CE**

**Step 7: In the .NET Compact Framework version, select .NET Compact Framework Version 3.5.**

### Tips & Warnings



Windows CE7 only supports .NET Compact Framework Version 3.5, if your application uses .NET Compact Framework Version 2.0 there is no guarantee that the program will function correctly.

**Step 8: In the list of templates, select Device Application. Click OK**

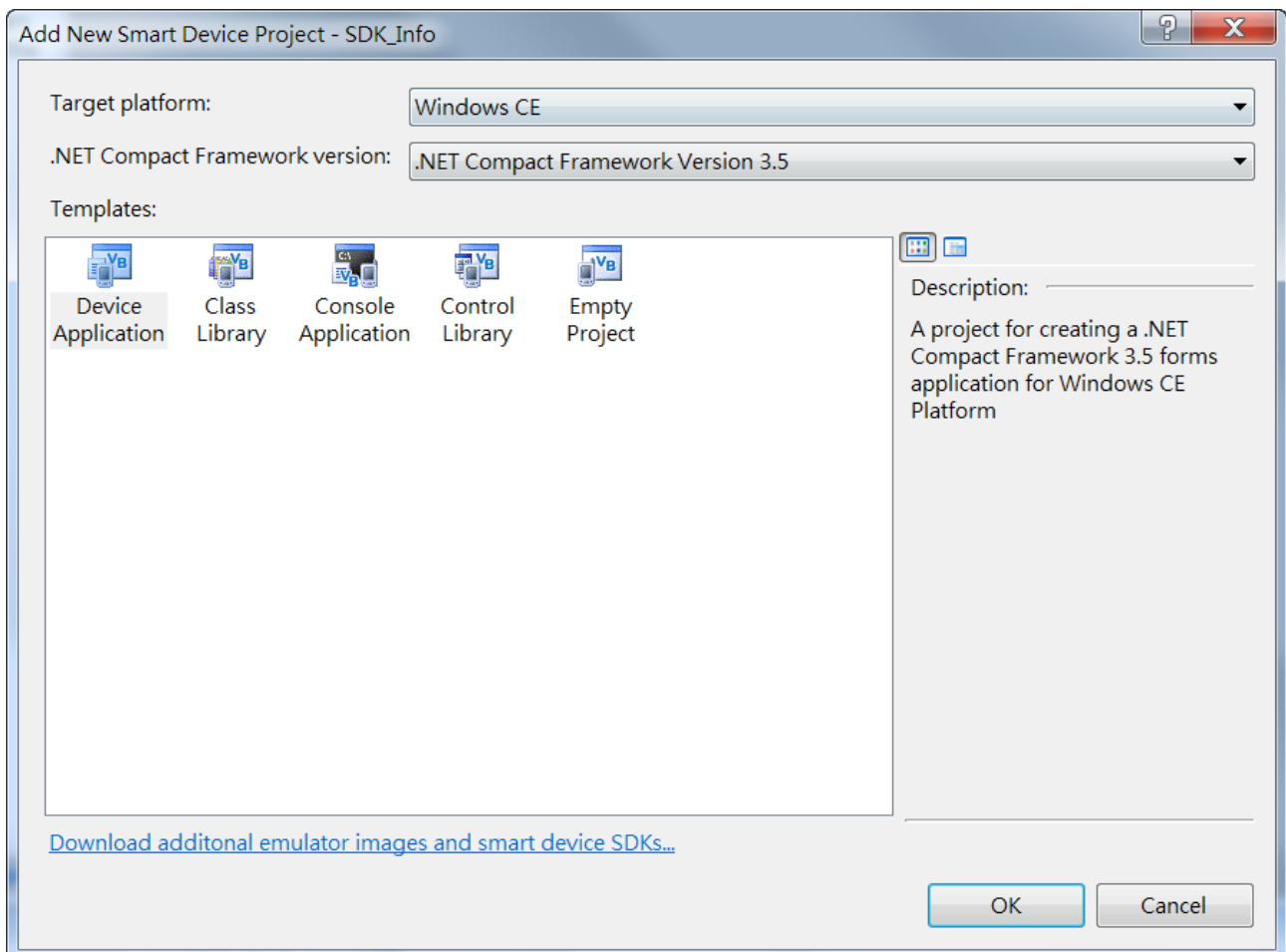

## 4.2.2. Specify the path of the PAC reference

The PAC SDK provides a complete solution to integrate with VP-x231-CE7 and it's compatible with Visual C#, Visual Basic.NET and C++. In order to use a component in your application, you must first add a reference to it.

### Step1: Get the PACNET.dll



The PACNET.dll can be found from the CD that was provided with the package or by downloading the latest version from ICP DAS web site.

CD:\VP-x231\SDK\PACNET\

[http://ftp.icpdas.com/pub/cd/winpac\\_am335x/vp-x231/sdk/pacnet/](http://ftp.icpdas.com/pub/cd/winpac_am335x/vp-x231/sdk/pacnet/)

### Step 2: On the Project menu, and then click Add Reference...

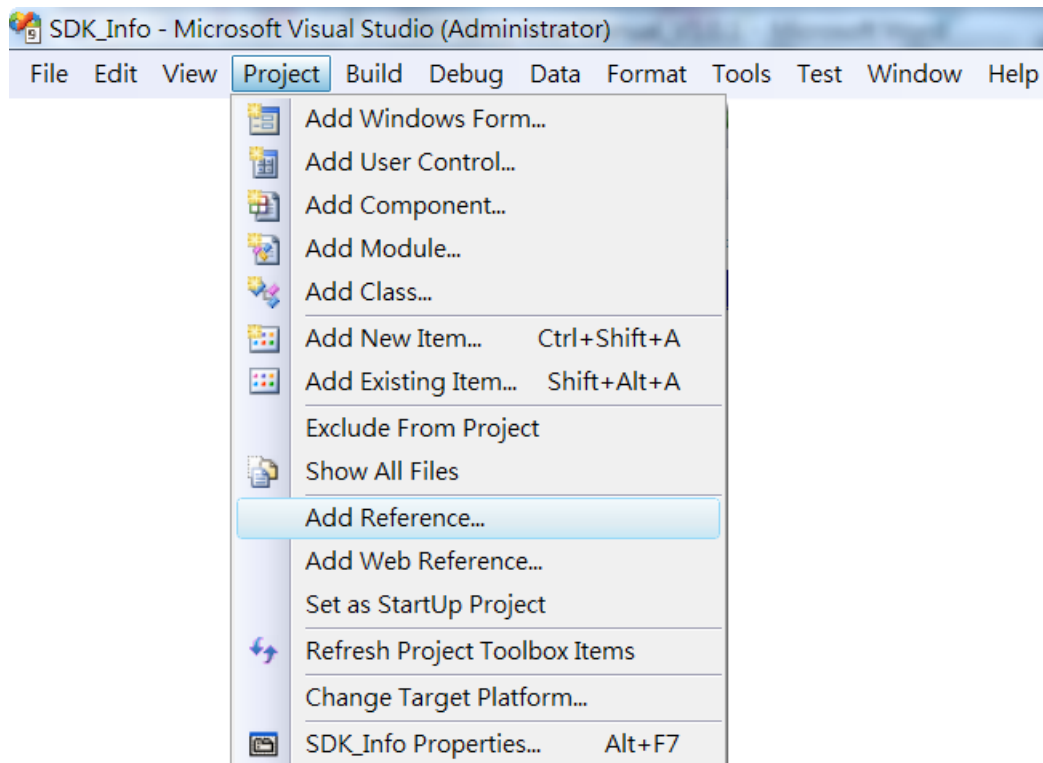

**Step 3: On the Browse tab and browse to where the PACNET.dll are installed, and then click OK**

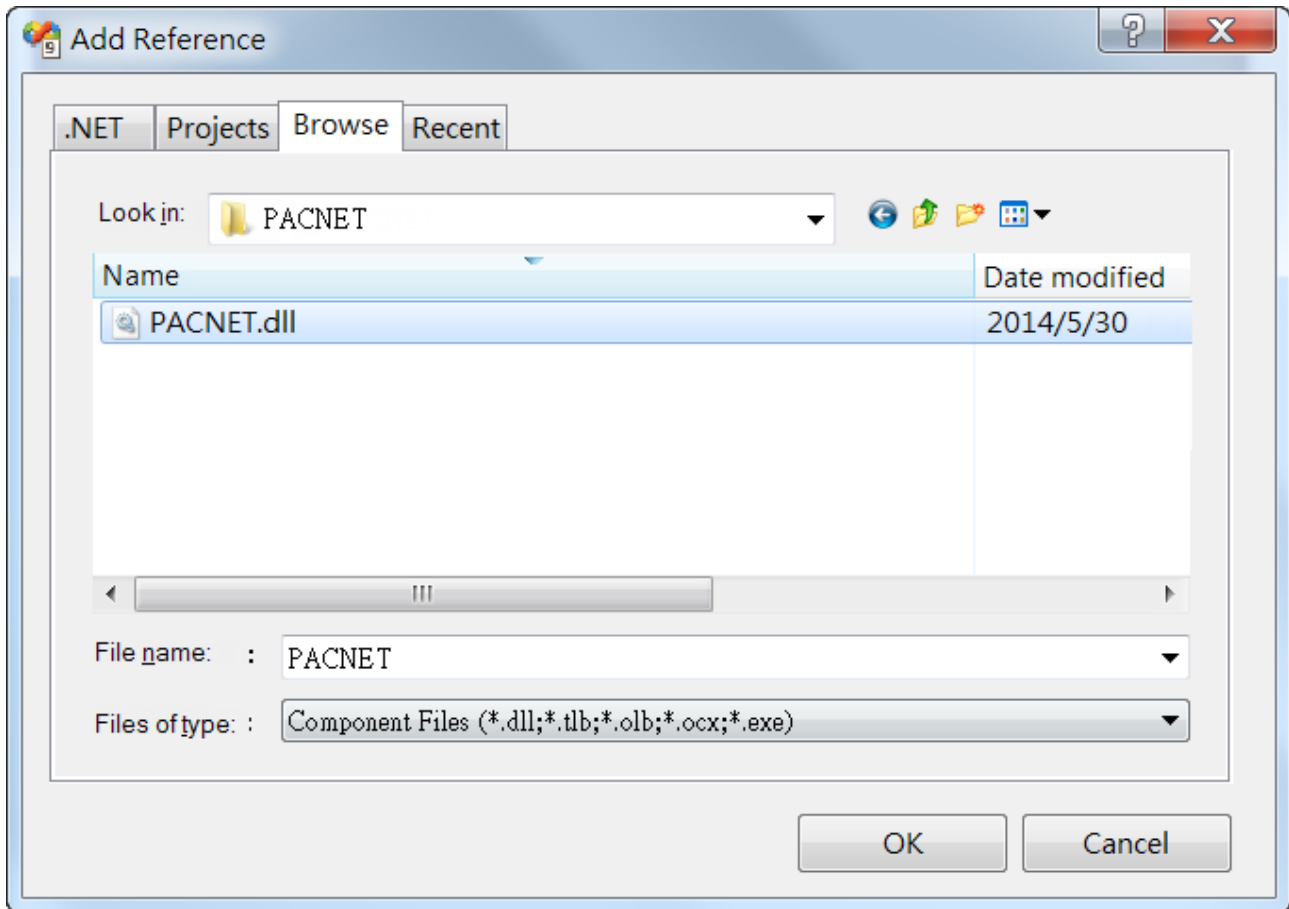

### 4.2.3. Add the control to the form

You can drag various controls from the Toolbox onto the form. These controls are not really "live"; they are just images that are convenient to move around on the form into a precise location.

After you add a control to your form, you can use the Properties window to set its properties, such as background color and default text. The values that you specify in the Properties window are the initial values that will be assigned to that property when the control is created at run time.

#### Step 1: On the Toolbox panel, drag a Button control onto the form

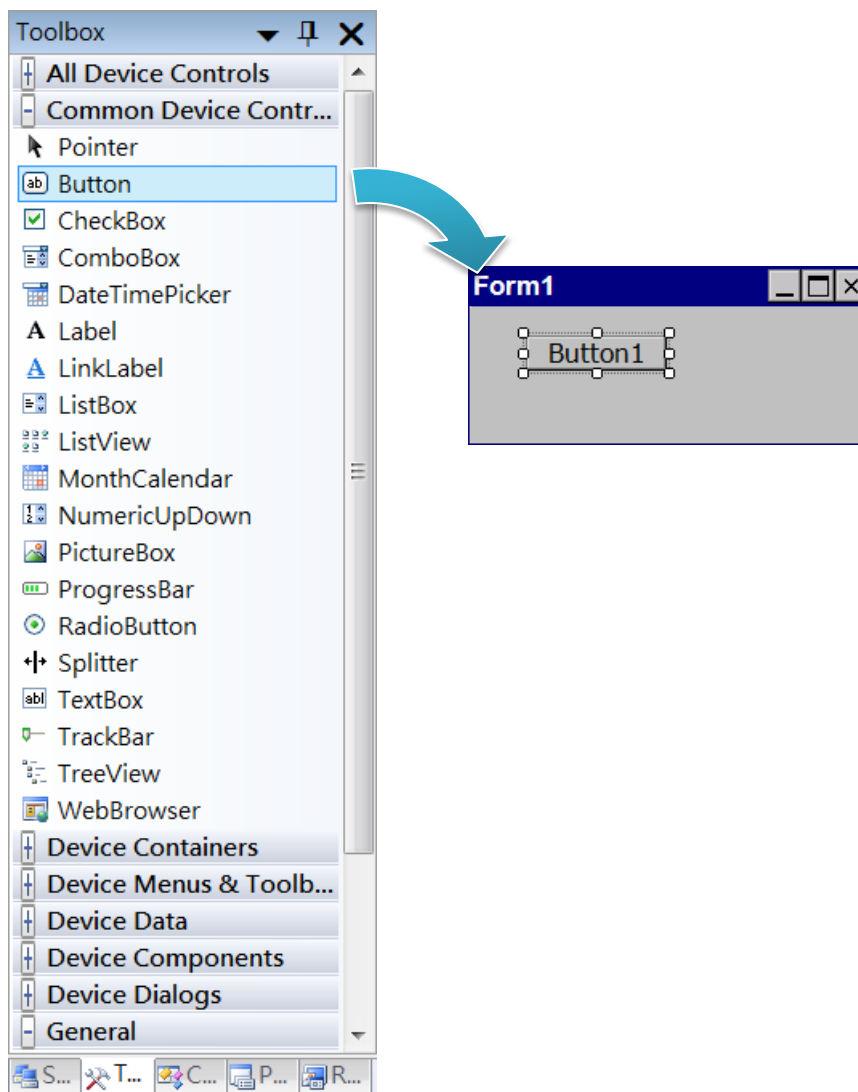

**Step 2: On the Properties panel, type Check the SDK version in the Text field**

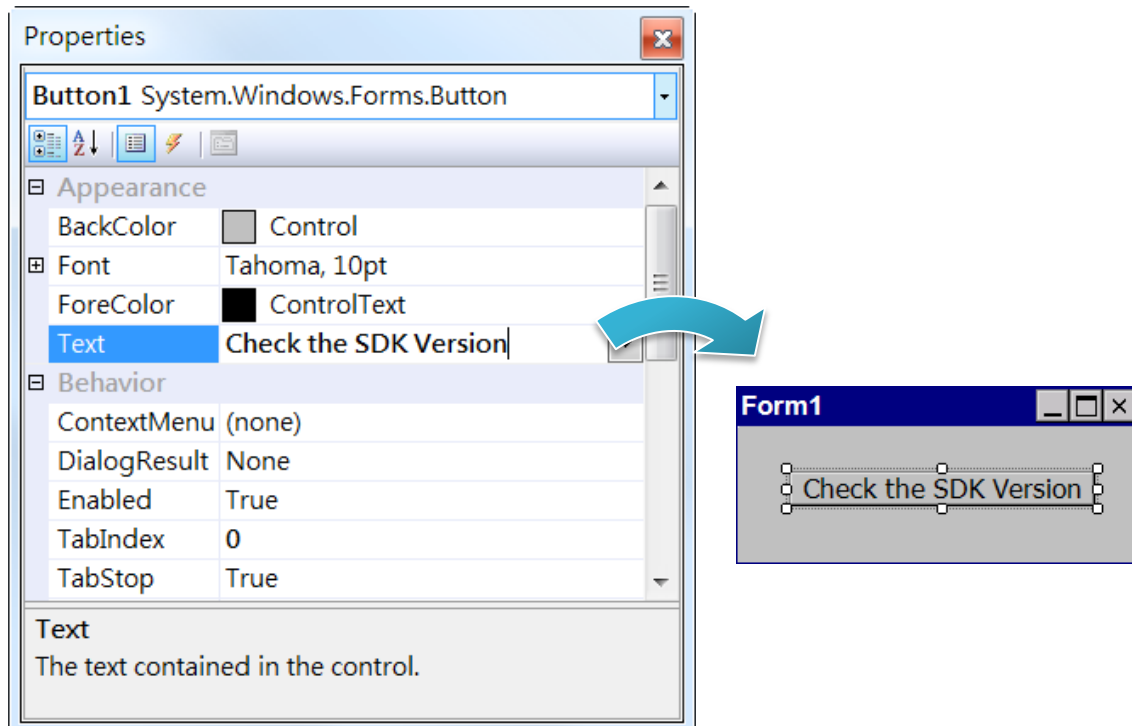

#### 4.2.4. Add the event handling for the control

You have finished the design stage of your application and are at the point when you can start adding some code to provide the program's functionality.

##### Step 1: Double-click the button on the form

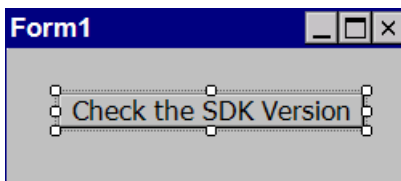

##### Step 2: Inserting the following code

```
Dim data(30) As Byte  
PACNET.Sys.GetSDKVersion(data)  
MessageBox.Show(PACNET.MISC.WideString(data))
```

```
Public Class Form1  
    Private Sub Button1_Click(ByVal sender As System.Object, ByVal e As  
        Dim data(30) As Byte  
        PACNET.Sys.GetSDKVersion(data)  
        MessageBox.Show(PACNET.MISC.WideString(data))  
    End Sub  
End Class
```

#### Tips & Warnings



The "PACNET" of "using PACNET" is case- sensitive.

#### 4.2.5. Upload the application to VP-x231-CE7

VP-x231-CE7 supports FTP server service. You can upload files to VP-x231-CE7 or download files from a public FTP server.

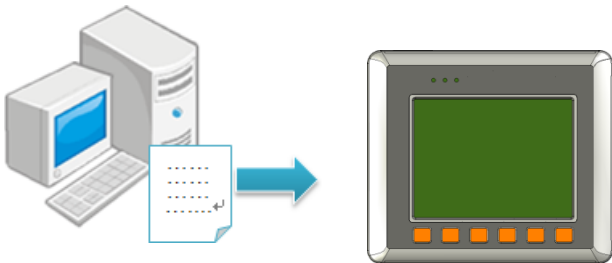

**Step 1: On the Build menu, and then click Build [Project Name]**

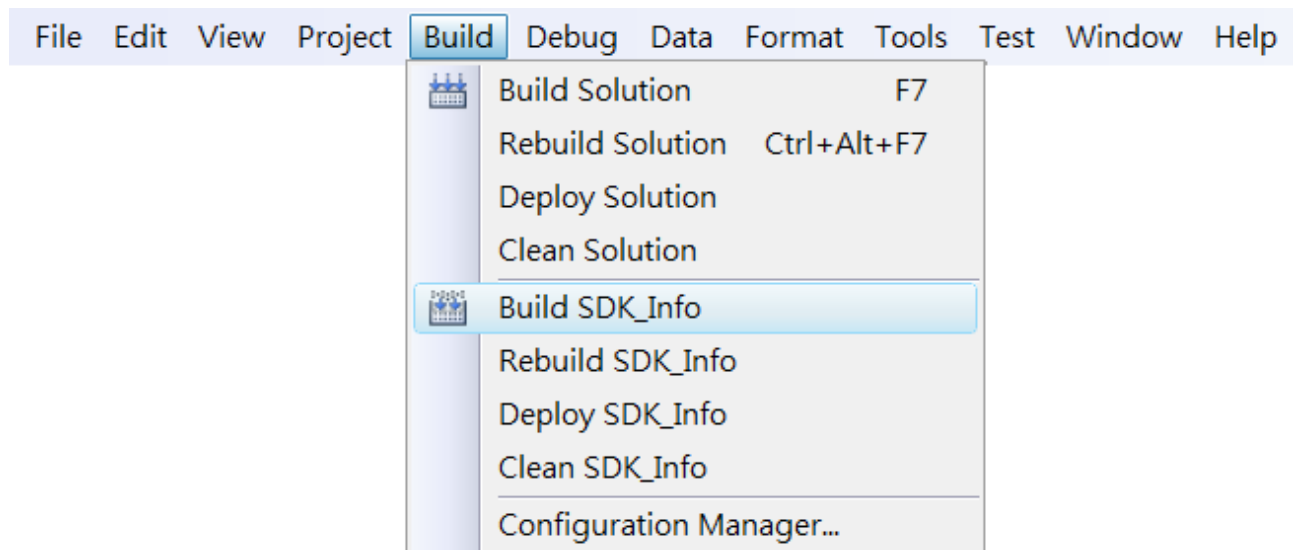

**Step 2: Open the browser and type the IP address of VP-x231-CE7**

**Step 3: Upload the application and the corresponding PACNET.dll files to VP-x231-CE7**

### Tips & Warnings

---



For applications programming in C# and VB.net with .net compact framework, when executing these application on VP-x231-CE7, the corresponding PACNET.dll must be in the same directory as the .exe file.

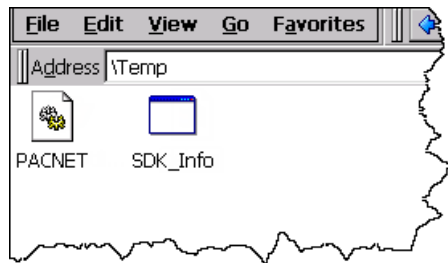



#### 4.2.6. Execute the application on VP-x231-CE7

After uploading the application to VP-x231-CE7, you can just double-click it on VP-x231-CE7 to execute it.

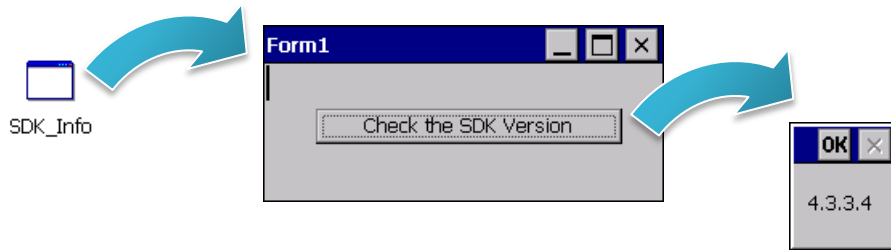

### 4.3. First VP-x231-CE7 Program in Visual C#

The best way to learn programming with VP-x231-CE7 is to actually create a VP-x231-CE7 program.

The example below demonstrates how to create a demo program running on VP-x231-CE7 with Visual C#.

To create a demo program with Visual C# that includes the following main steps:

1. Create a new project
2. Specify the path of the PAC reference
3. Add the control to the form
4. Add the event handling for the control
5. Upload the application to VP-x231-CE7
6. Execute the application on VP-x231-CE7

All main steps will be described in the following subsection.

In this tutorial, we will assume that you have installed VP-x231-CE7 SDK on PC and used the Visual Studio 2008 for application development.

### 4.3.1. Create a new project

The Visual C# project template is a composite control that you use in this example creates a new project with this user control.

#### Step 1: Start Visual Studio 2008



#### Step 2: On the File menu, point to New, and then click Project

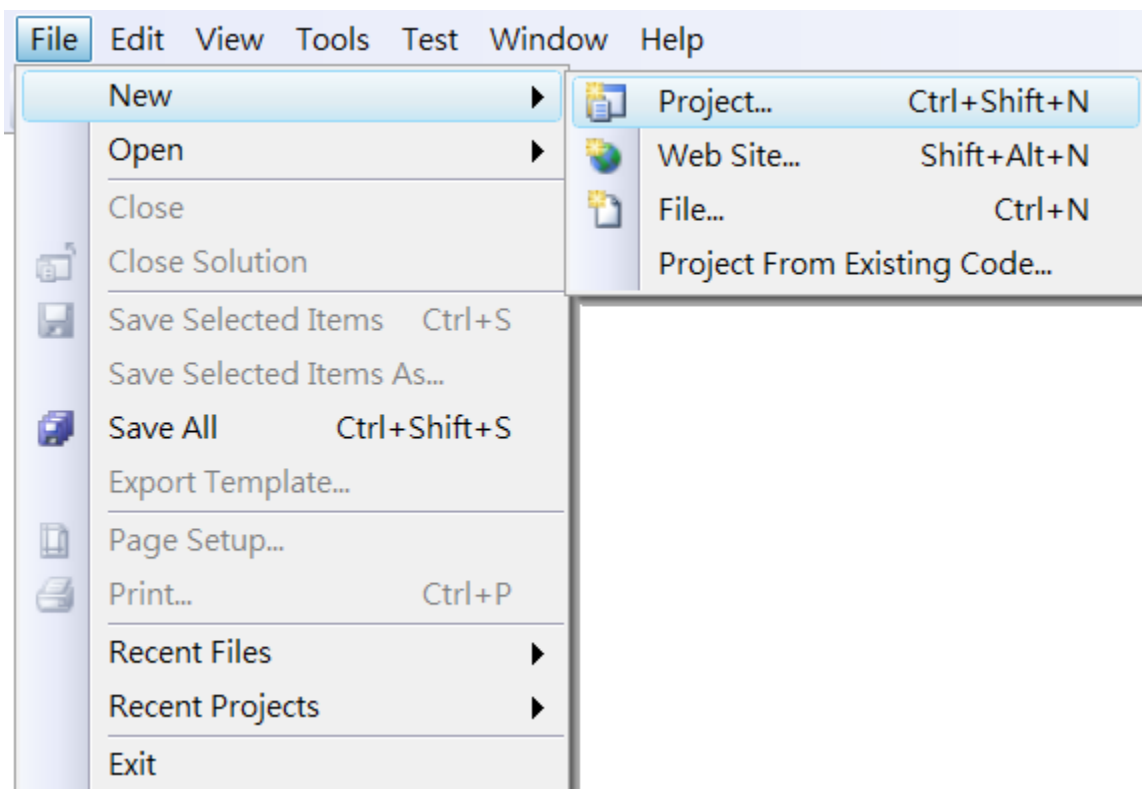

**Step 3: In the Project types pane, expand Visual C# node and select Smart Device**

**Step 4: In the list of Templates, select Smart Device Project**

**Step 5: Specify a name and a location for the application and then click OK**

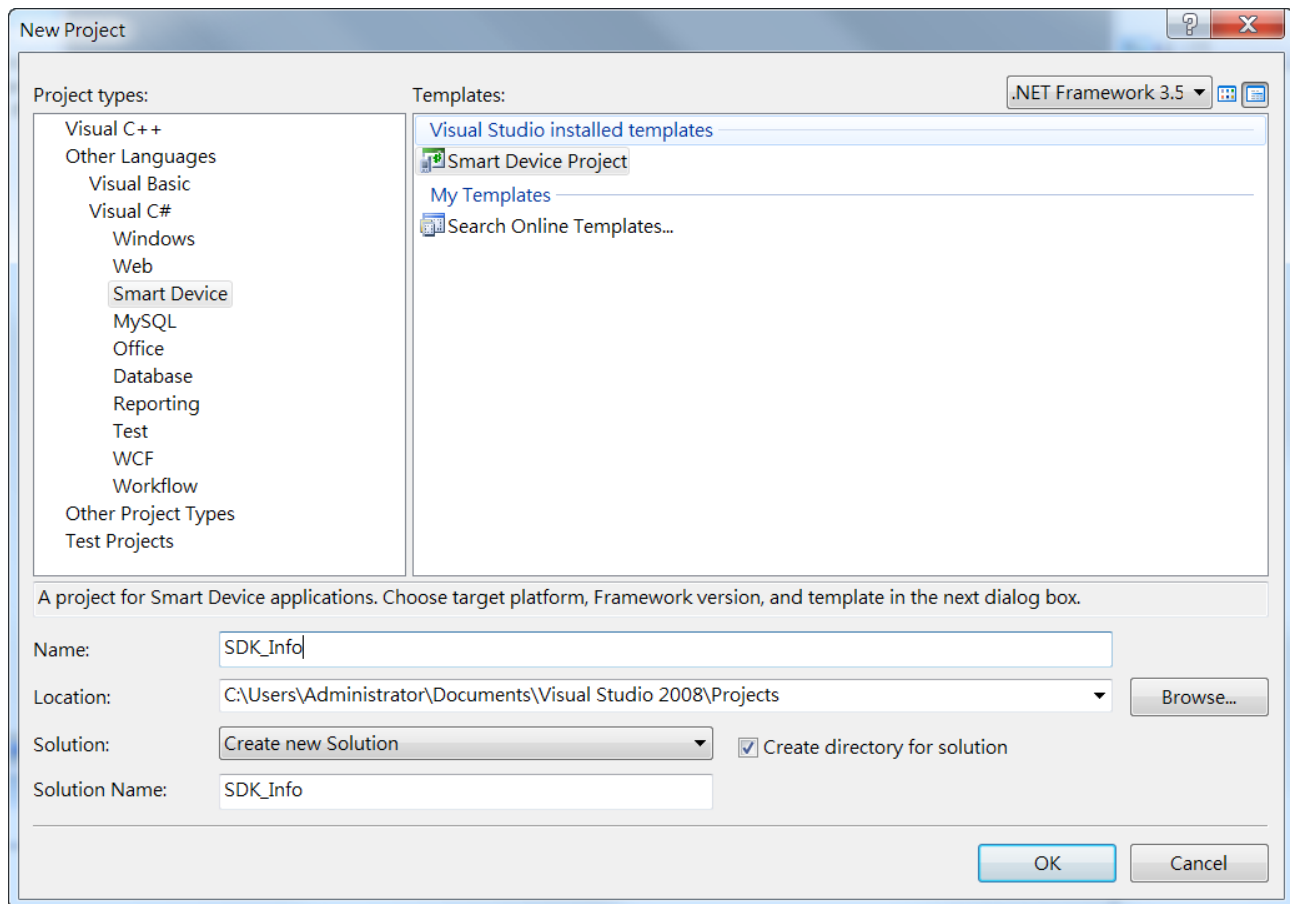

**Step 6: In the Target platform, select Windows CE**

**Step 7: In the .NET Compact Framework version, select .NET Compact Framework Version 3.5.**

### Tips & Warnings



Windows CE7 only supports .NET Compact Framework Version 3.5, if your application uses .NET Compact Framework Version 2.0 there is no guarantee that the program will function correctly.

**Step 8: In the list of templates, select Device Application. Click OK**

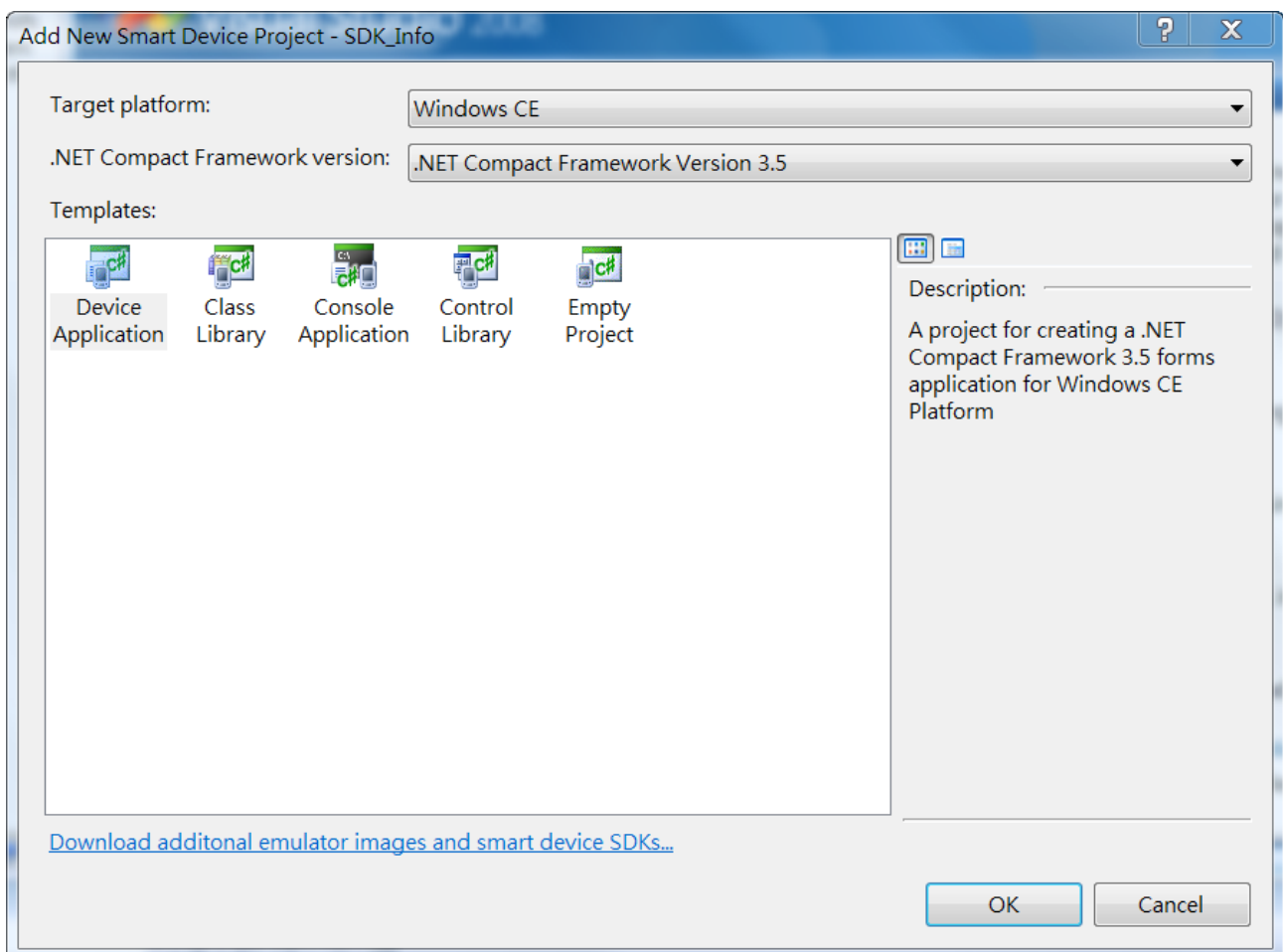

### 4.3.2. Specify the path of the PAC reference

The PAC SDK provides a complete solution to integrate with VP-x231-CE7 and it's compatible with Visual C#, Visual Basic.NET and C++. In order to use a component in your application, you must first add a reference to it.

#### Step1: Get the PACNET.dll



The PACNET.dll can be found from the CD that was provided with the package or by downloading the latest version from ICP DAS web site.

CD:\VP-x231\SDK\PACNET\

[http://ftp.icpdas.com/pub/cd/winpac\\_am335x/vp-x231/sdk/pacnet/](http://ftp.icpdas.com/pub/cd/winpac_am335x/vp-x231/sdk/pacnet/)

#### Step 2: On the Project menu, and then click Add Reference...

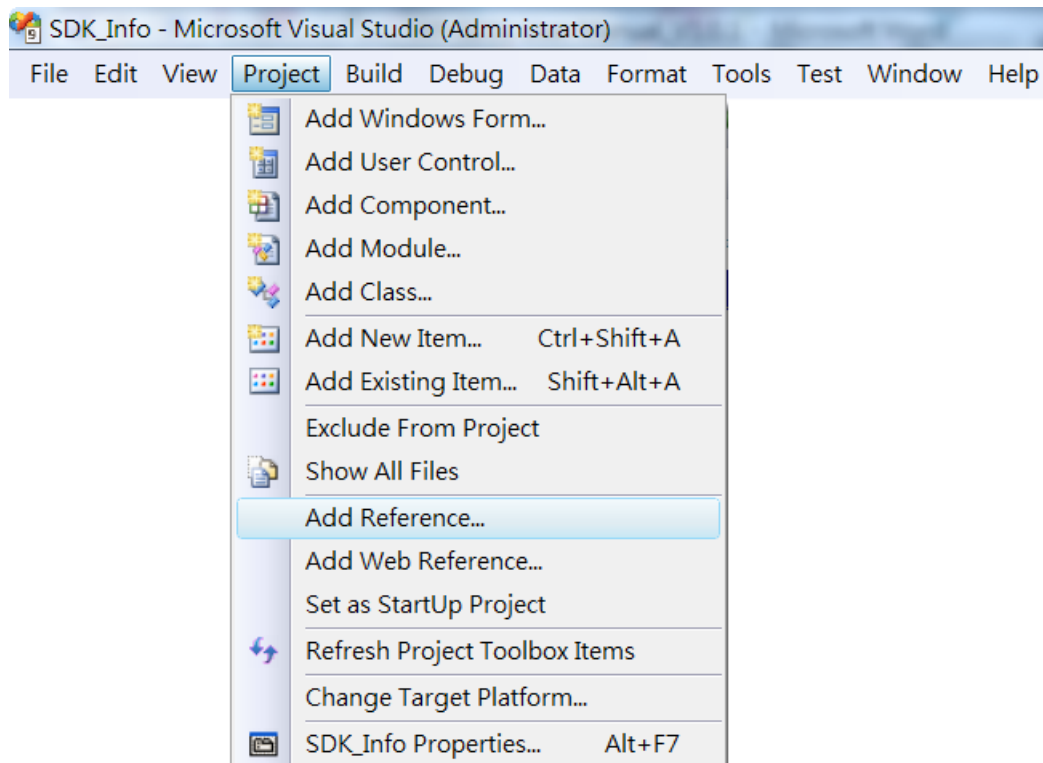

**Step 3: On the Browse tab and browse to where the PACNET.dll are installed, and then click OK**

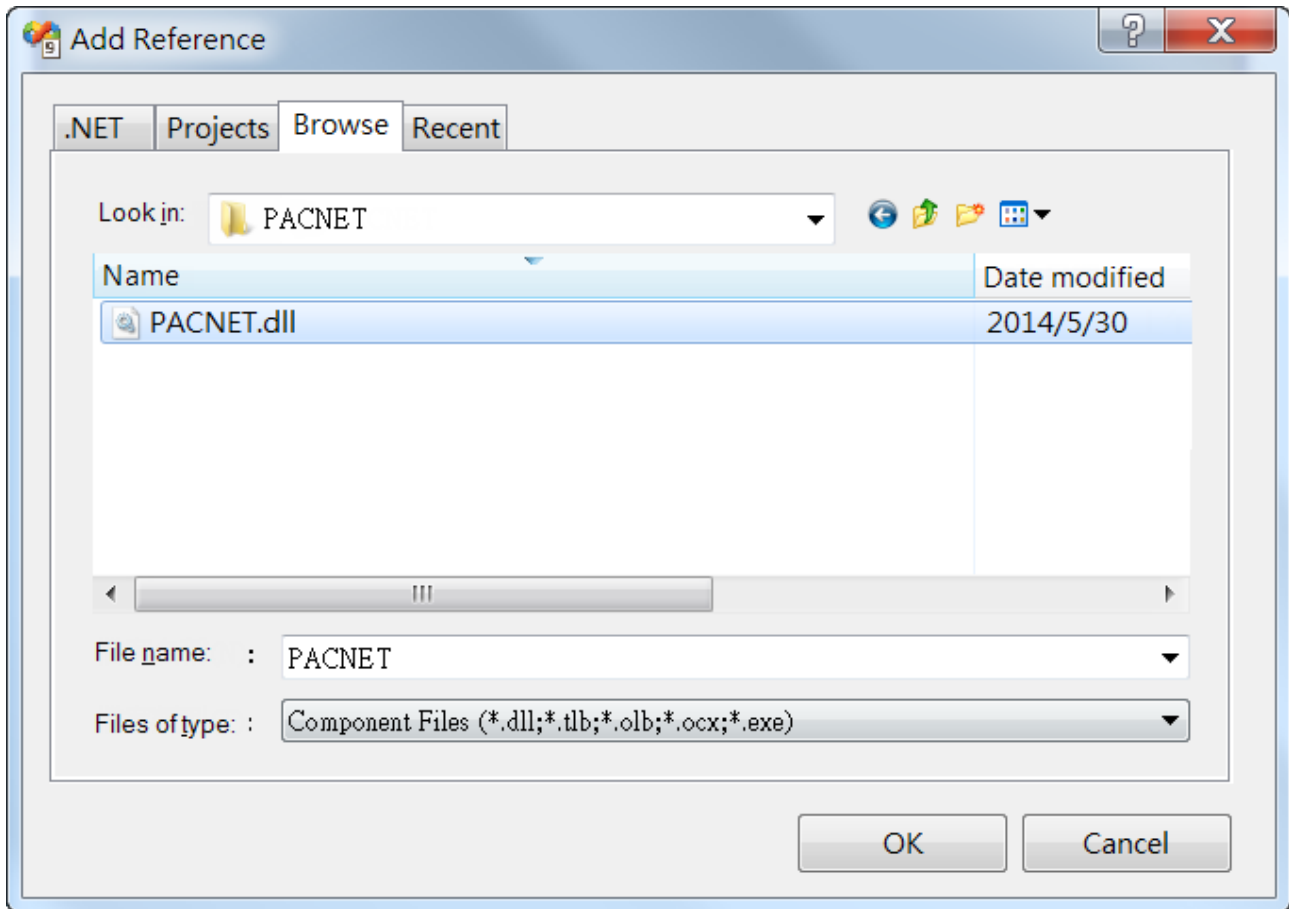

### 4.3.3. Add the control to the form

You can drag various controls from the Toolbox onto the form. These controls are not really "live"; they are just images that are convenient to move around on the form into a precise location.

After you add a control to your form, you can use the Properties window to set its properties, such as background color and default text. The values that you specify in the Properties window are the initial values that will be assigned to that property when the control is created at run time.

#### Step 1: On the Toolbox panel, drag a Button control onto the form

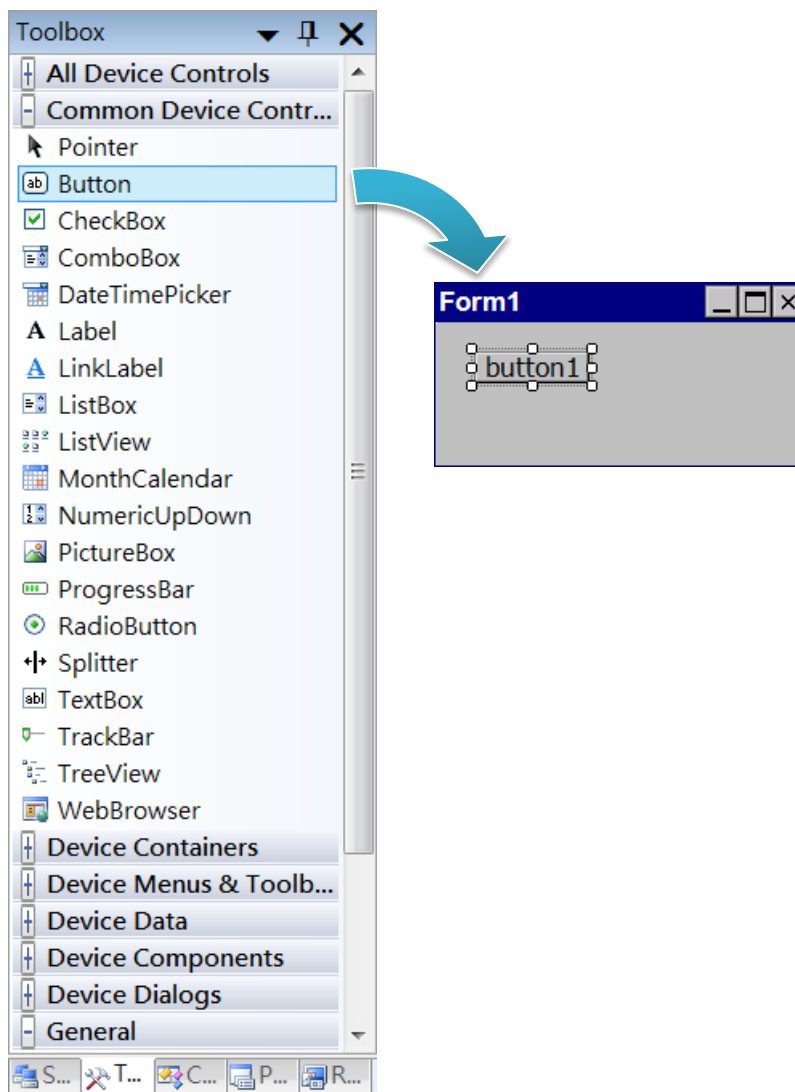



**Step 2: On the Properties panel, type Check the SDK version in the Text field**

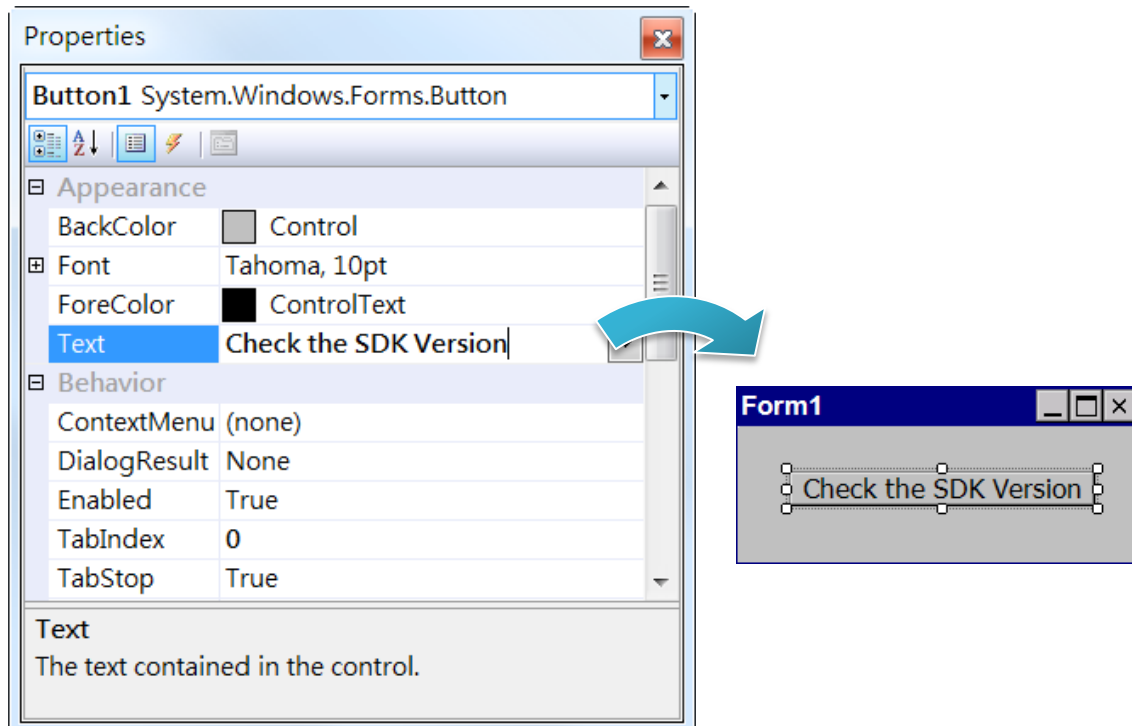

#### 4.3.4. Add the event handling for the control

You have finished the design stage of your application and are at the point when you can start adding some code to provide the program's functionality.

##### Step 1: Double-click the button on the form

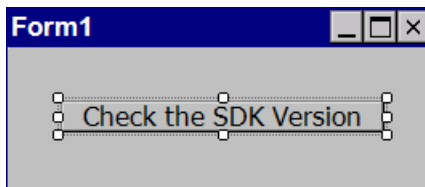

##### Step 2: Inserting the following code

```
byte[] data = new byte[30];  
PACNET.Sys.GetSDKVersion(data);  
MessageBox.Show(PACNET.MISC.WideString(data));
```

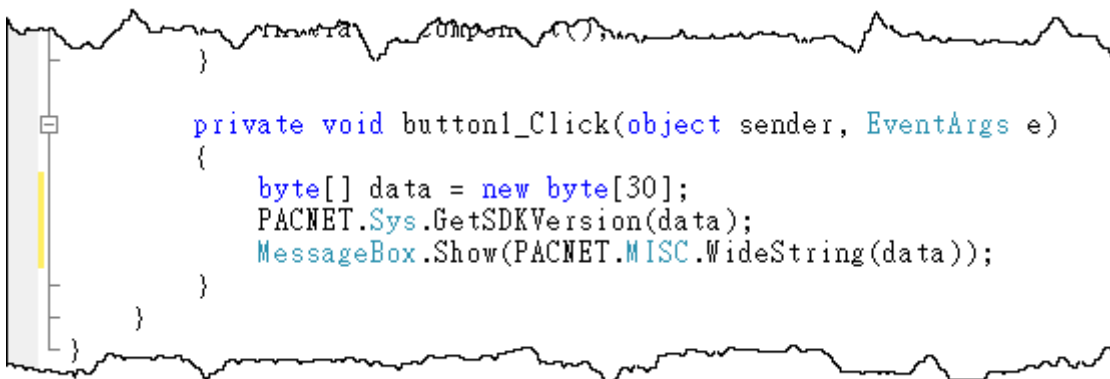

#### Tips & Warnings



The "PACNET" of "using PACNET" is case- sensitive.

### 4.3.5. Upload the application to VP-x231-CE7

VP-x231-CE7 supports FTP server service. You can upload files to VP-x231-CE7 or download files from a public FTP server.

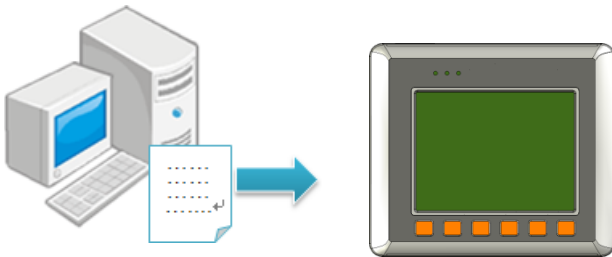

**Step 1: On the Build menu, and then click Build [Project Name]**

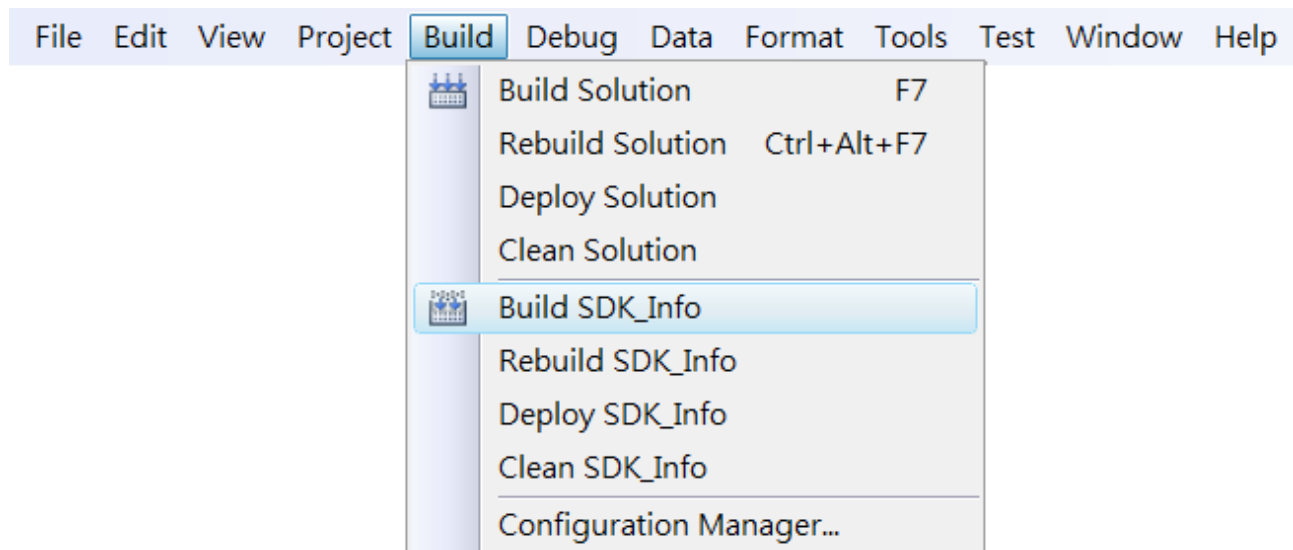

**Step 2: Open the browser and type the IP address of VP-x231-CE7**

**Step 3: Upload the application and the corresponding PACNET.dll files to VP-x231-CE7**

### Tips & Warnings

---



For applications programming in C# and VB.net with .net compact framework, when executing these application on VP-x231-CE7, the corresponding PACNET.dll must be in the same directory as the .exe file.

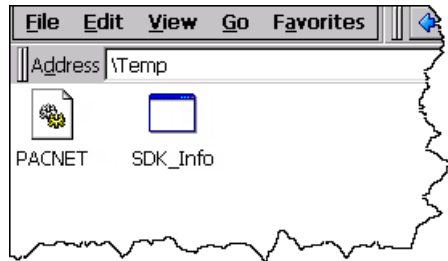

### 4.3.6. Execute the application on VP-x231-CE7

After uploading the application to VP-x231-CE7, you can just double-click it on VP-x231-CE7 to execute it.

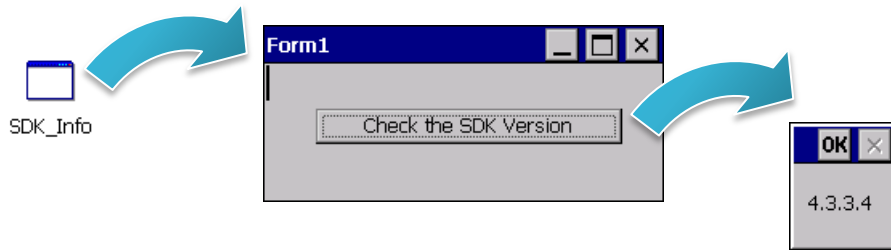

## 4.4. First VP-x231-CE7 Program in Visual C++

The best way to learn programming with VP-x231-CE7 is to actually create a VP-x231-CE7 program.

The example below demonstrates how to create a demo program running on VP-x231-CE7 with Visual C++.

To create a demo program with Visual C# that includes the following main steps:

1. Create a new project
2. Configure the Platform
3. Specify the path of the PAC reference
4. Add the control to the form
5. Add the event handling for the control
6. Upload the application to VP-x231-CE7
7. Execute the application on VP-x231-CE7

All main steps will be described in the following subsection.

In this tutorial, we will assume that you have installed VP-x231-CE7 SDK on PC and used the Visual Studio 2008 for application development.

#### 4.4.1. Create a new project

The Visual C# project template is a composite control that you use in this example creates a new project with this user control.

##### Step 1: Start Visual Studio 2008



##### Step 2: On the File menu, point to New, and then click Project

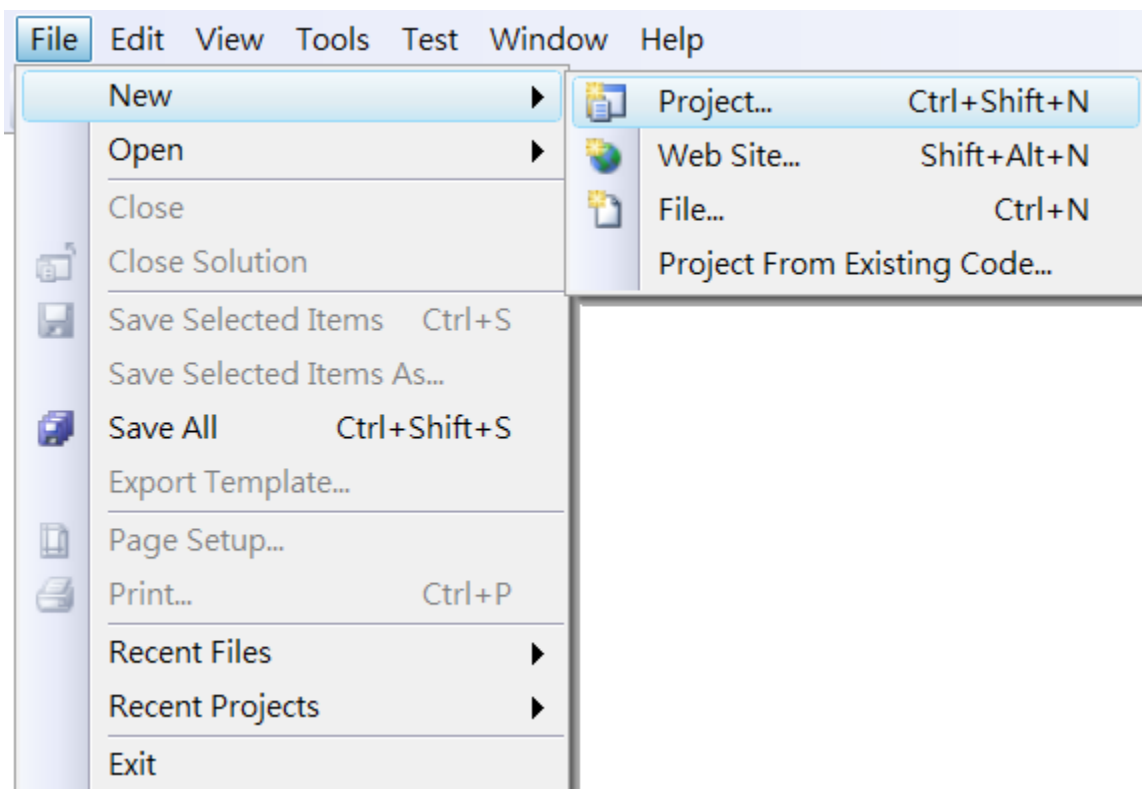

**Step 3: In the Project types pane, expand Visual C++ node and select Smart Device**

**Step 4: In the list of Templates, select MFC Smart Device Application**

**Step 5: Specify a name and a location for the application and then click OK**

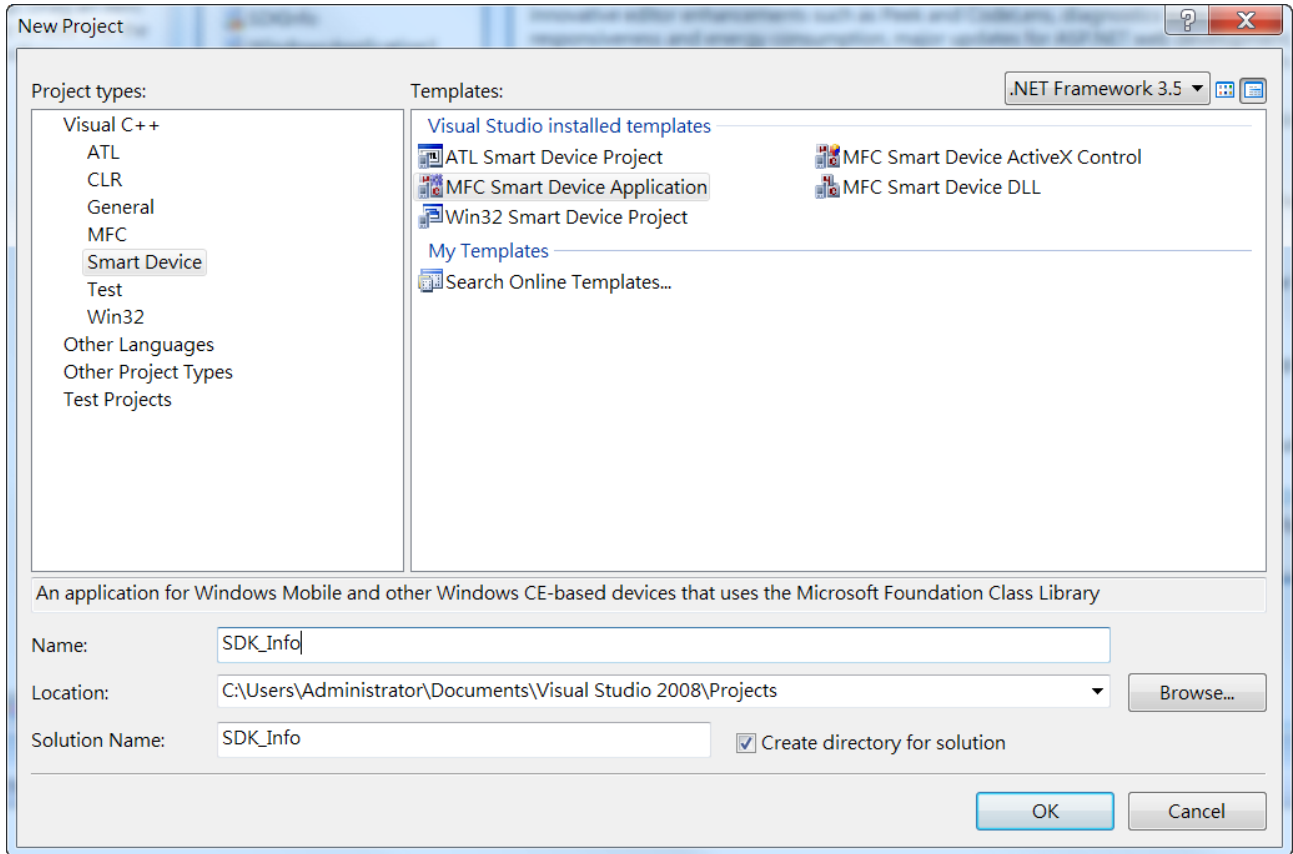



**Step 6: On the first page of the wizard, click Next**

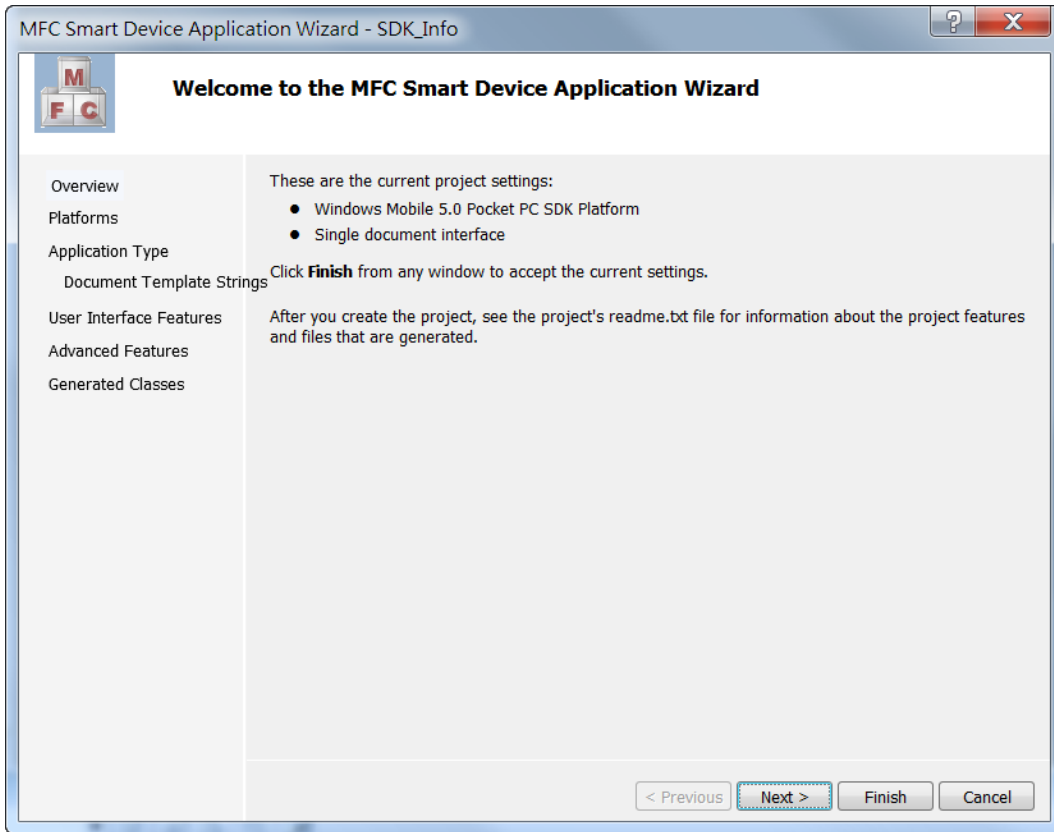

**Step 7: On the next page of the wizard, select AM335x\_WINCE7\_SDK to be added to the project, and then click Next**

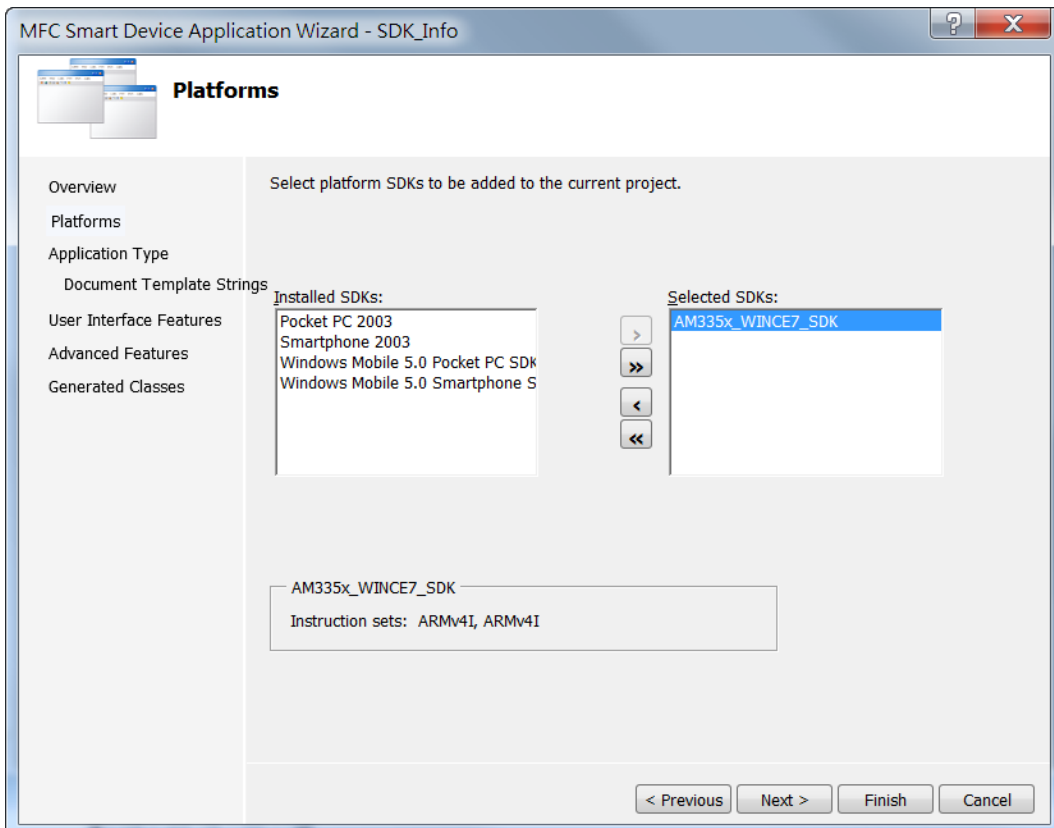

**Step 8: On the next page of the wizard, select Dialog based, and then click next**

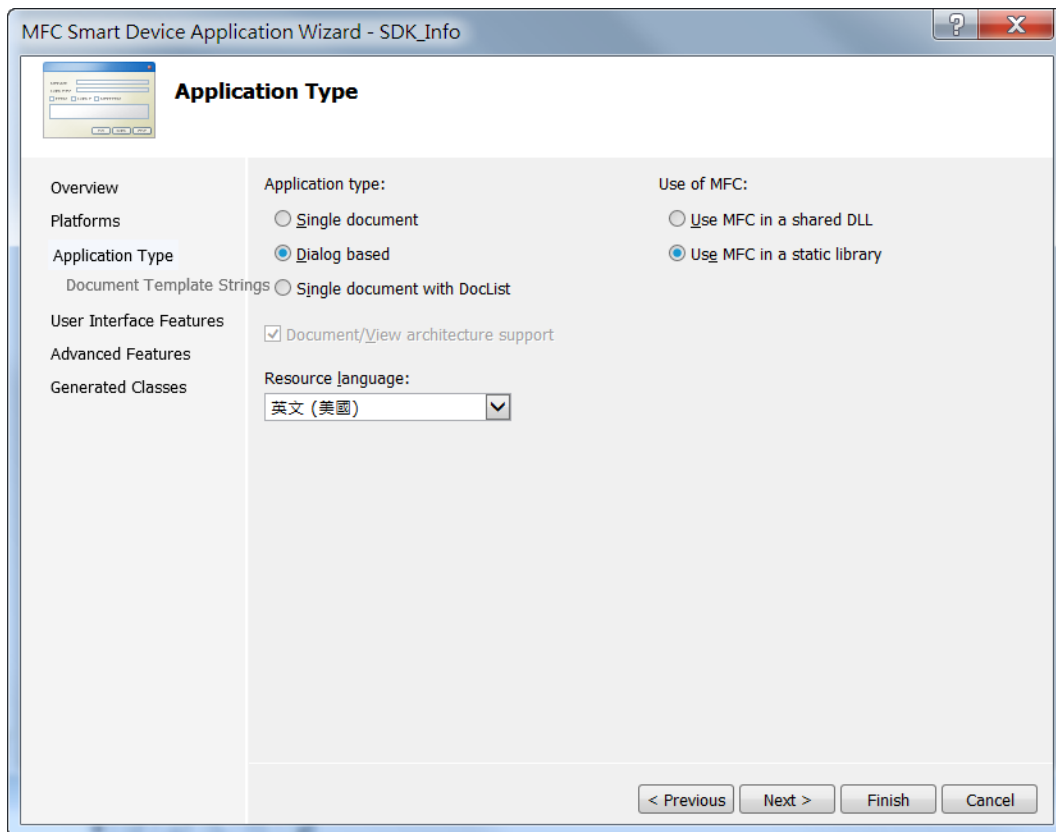

**Step 9: On the next page of the wizard, click next**

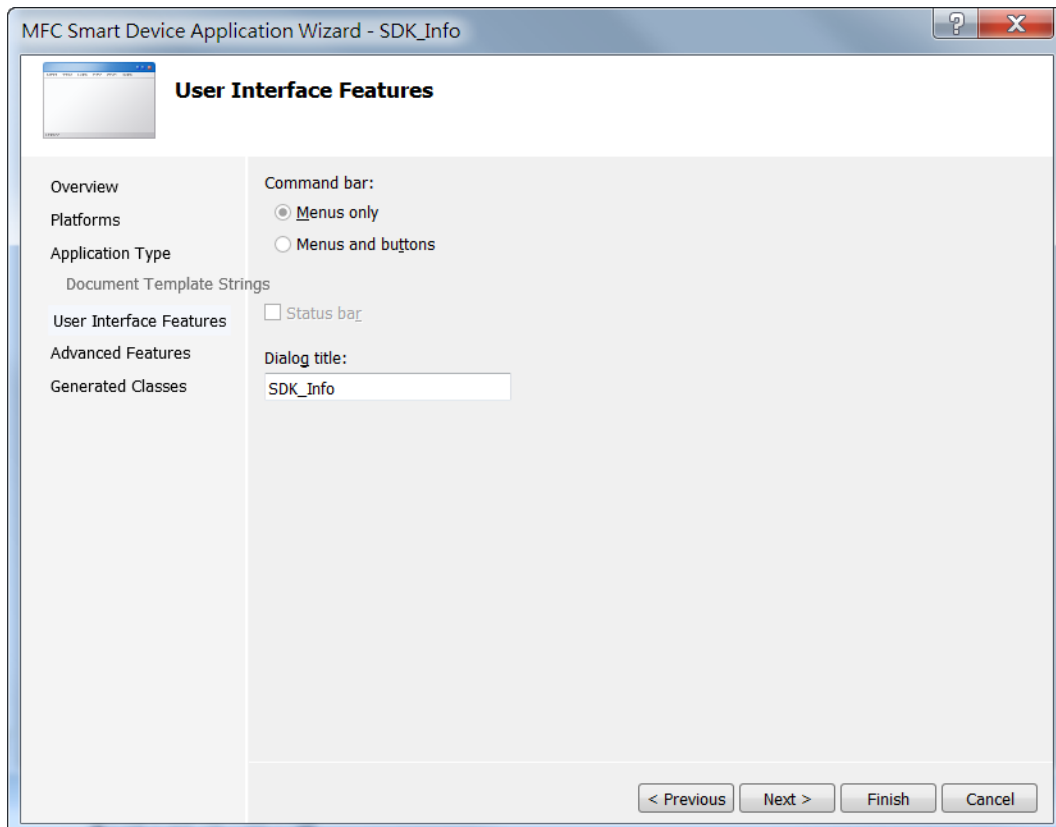

**Step 10: On the next page of the wizard, click next**

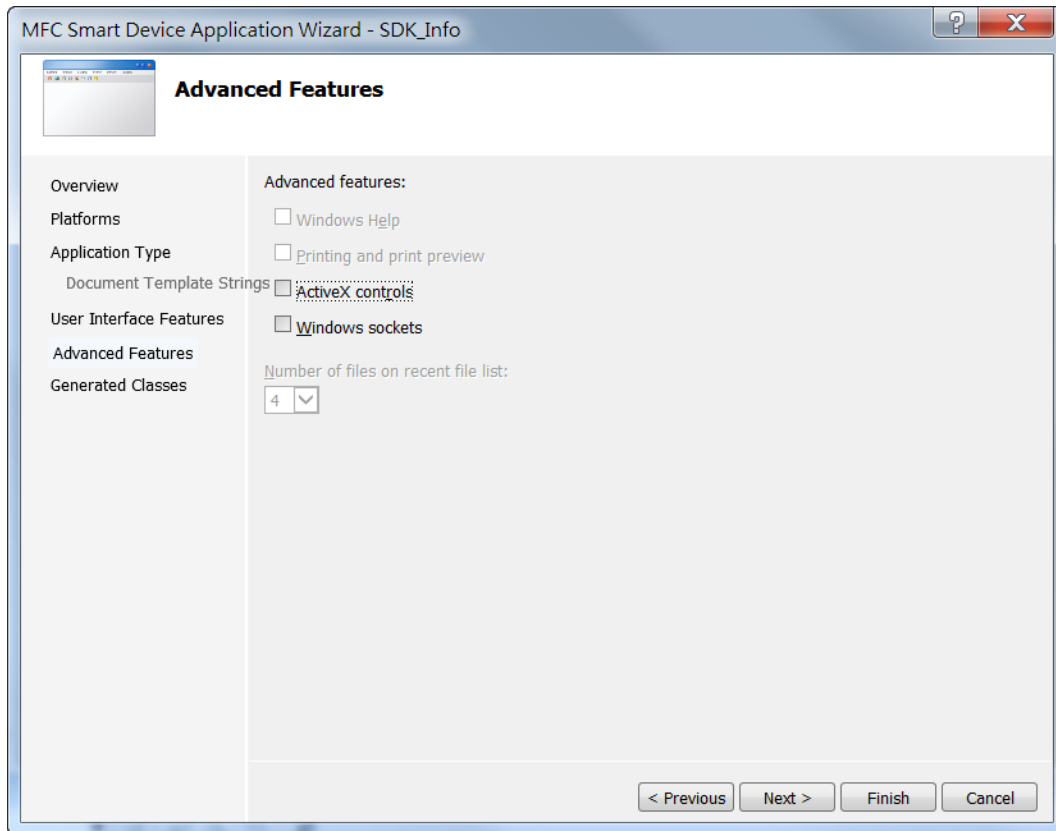

**Step 11: On the next page of the wizard, click Finish**

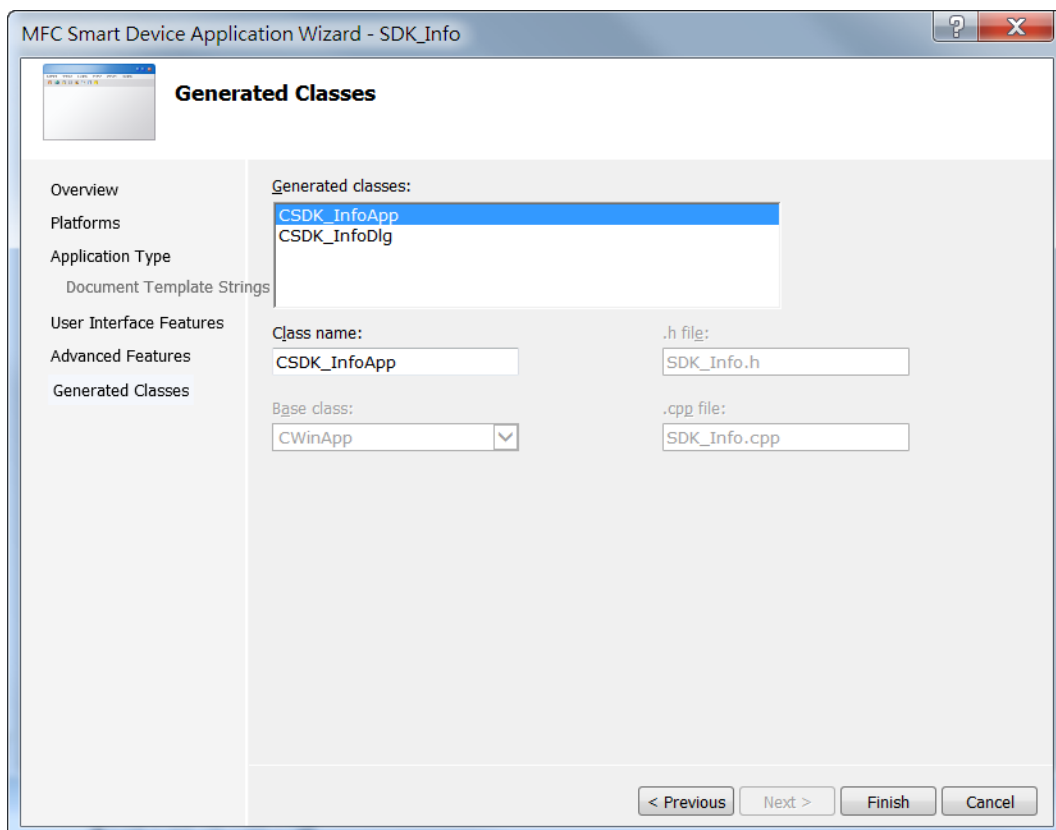

## 4.4.2. Configure the Platform

When developing applications by using Visual C++, you must configure the Platform to indicate what platform and device you intend to download the application to. Before you deploy your project, check the platform.

On the Debug configuration toolbar, select Release and select AM335x\_WINCE7\_SDK(ARMv4I) as shown in the following illustration.

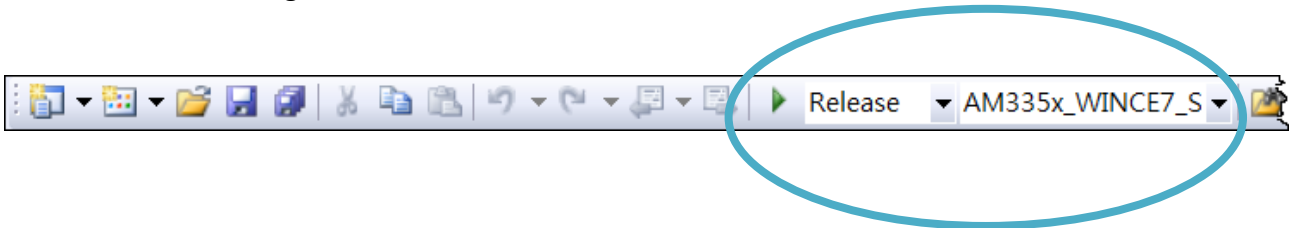

### 4.4.3. Specify the Path of PACSDK library and header files

The PAC SDK provides the PACSDK library and header files with VP-x231-CE7.

It's compatible with C++. In order to use a component in your application, you must first add a reference to it.

#### Step 1: On the View menu, and then click Property Pages

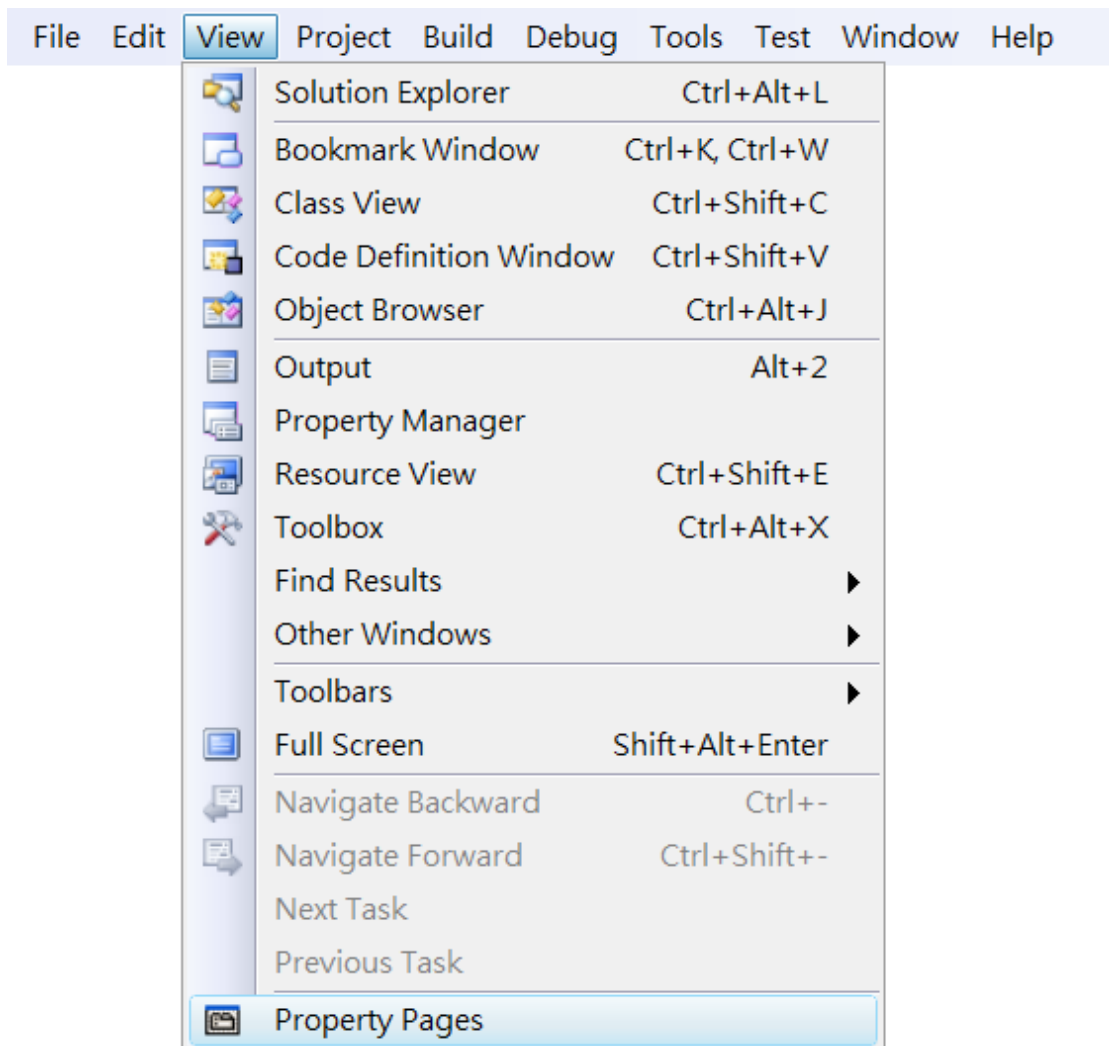

**Step 2: In left pane, expand Configuration Properties, and then click C/C++**

**Step 3: In the right pane, choose the following path in the Additional Include Dependencies item**

C:\Program Files\Windows CE Tools\SDKs\N2000\_WINCE7\_SDK\Include\Armv4i

C:\Program Files\Microsoft Visual Studio 9.0\VC\atlmfc\include

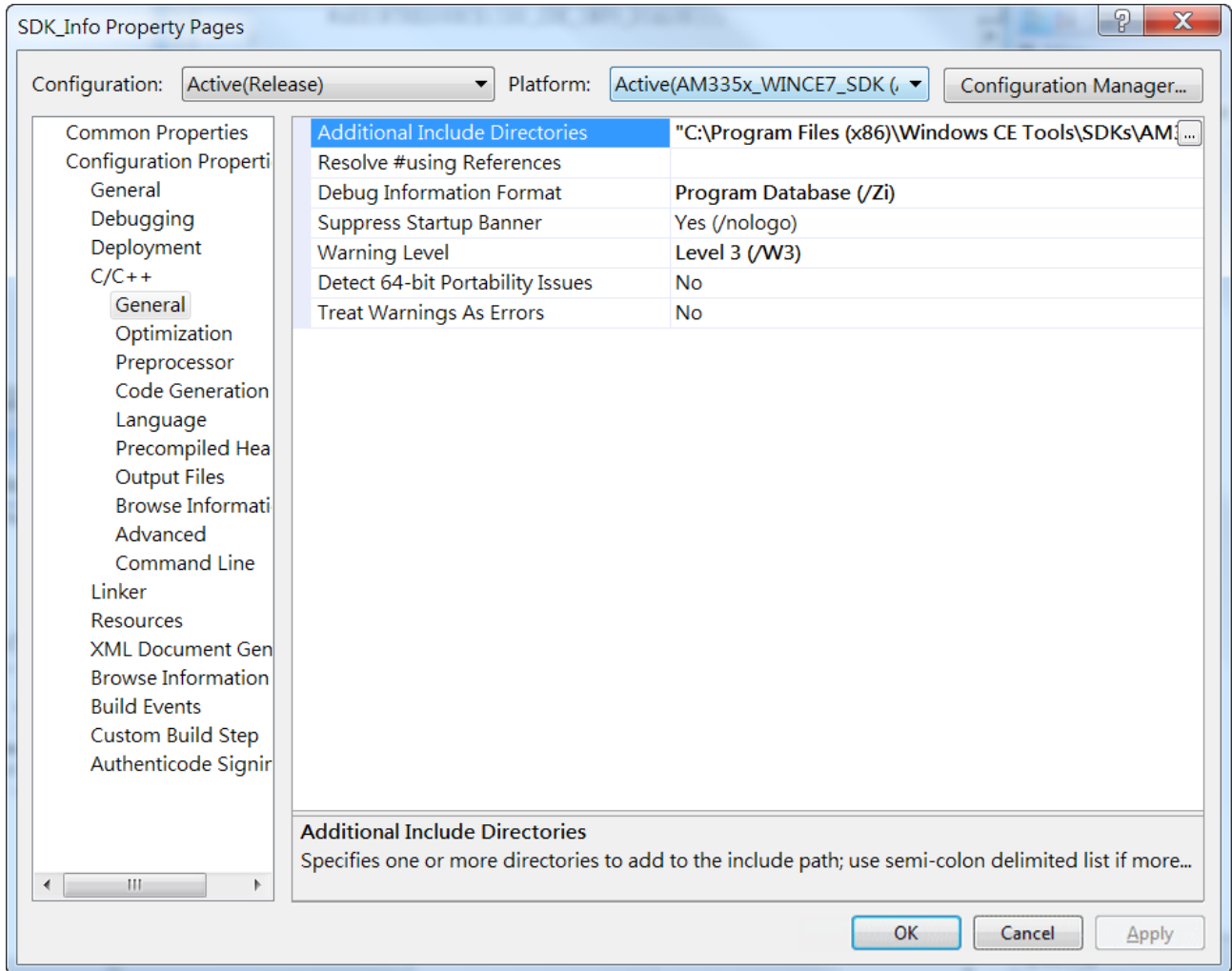

**Step 4: In left pane, click Linker**

**Step 5: In the right pane, choose the following path in the Additional Library Dependencies item**

C:\Program Files\Windows CE Tools\SDKs\N2000\_WINCE7\_SDK\Include\Armv4i

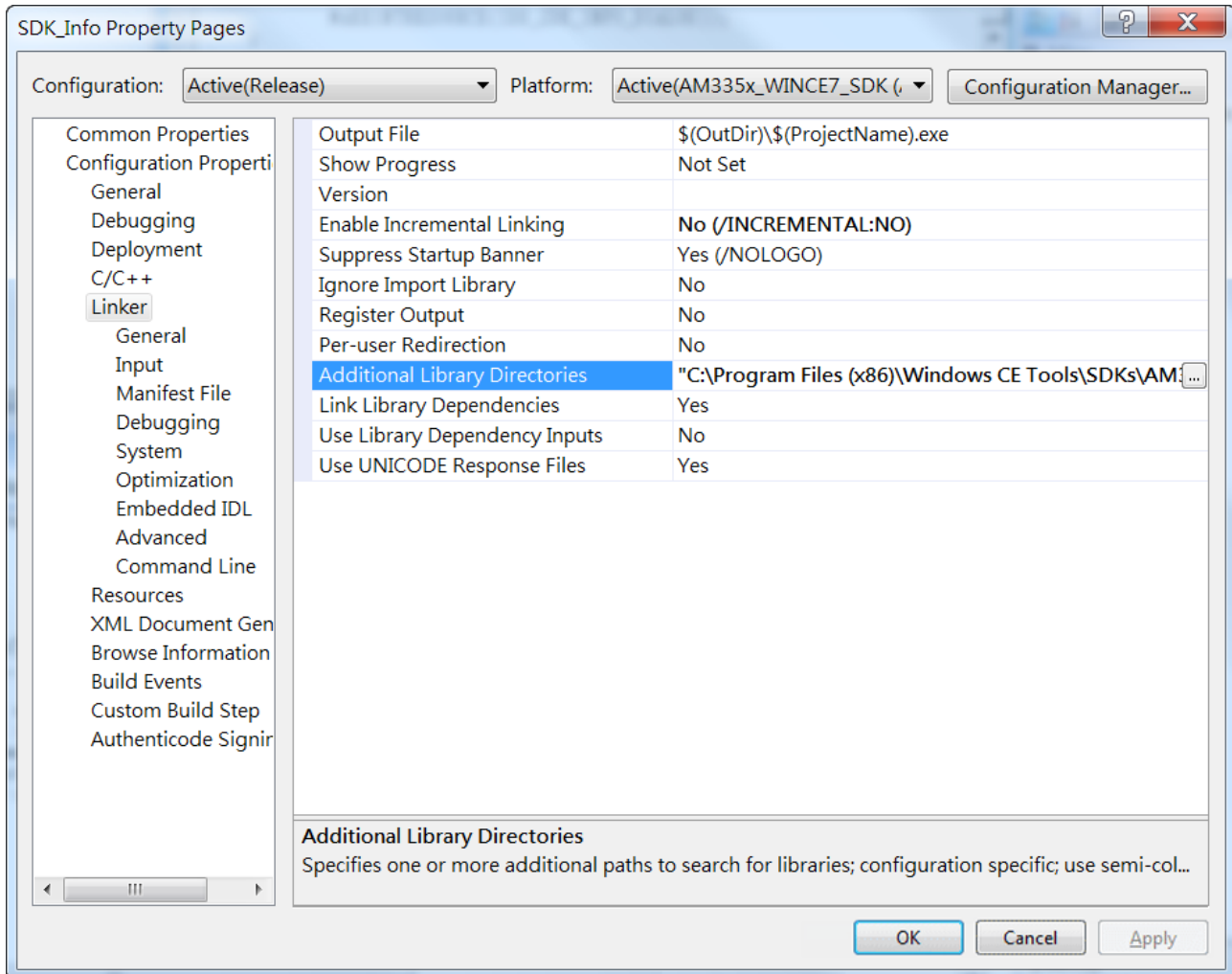

#### 4.4.4. Add the control to the form

You can drag various controls from the Toolbox onto the form. These controls are not really "live"; they are just images that are convenient to move around on the form into a precise location.

After you add a control to your form, you can use the Properties window to set its properties, such as background color and default text. The values that you specify in the Properties window are the initial values that will be assigned to that property when the control is created at run time.

#### Step 1: On the View menu, and then click Resource View

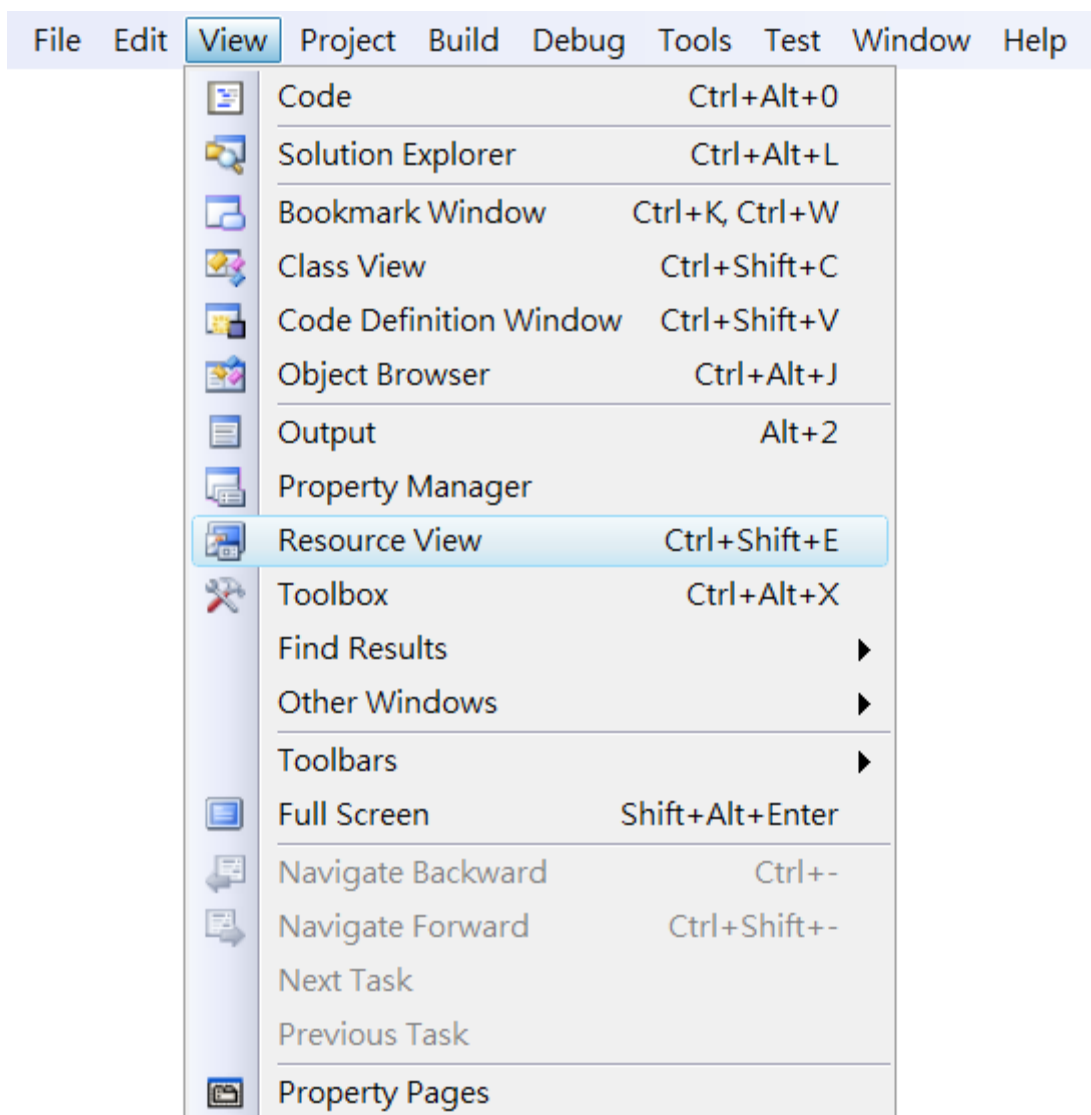



**Step 2: In the Resource View Panel, Expand the [Project name].rc file and then expand the Dialog item to click the plug-in dialog**

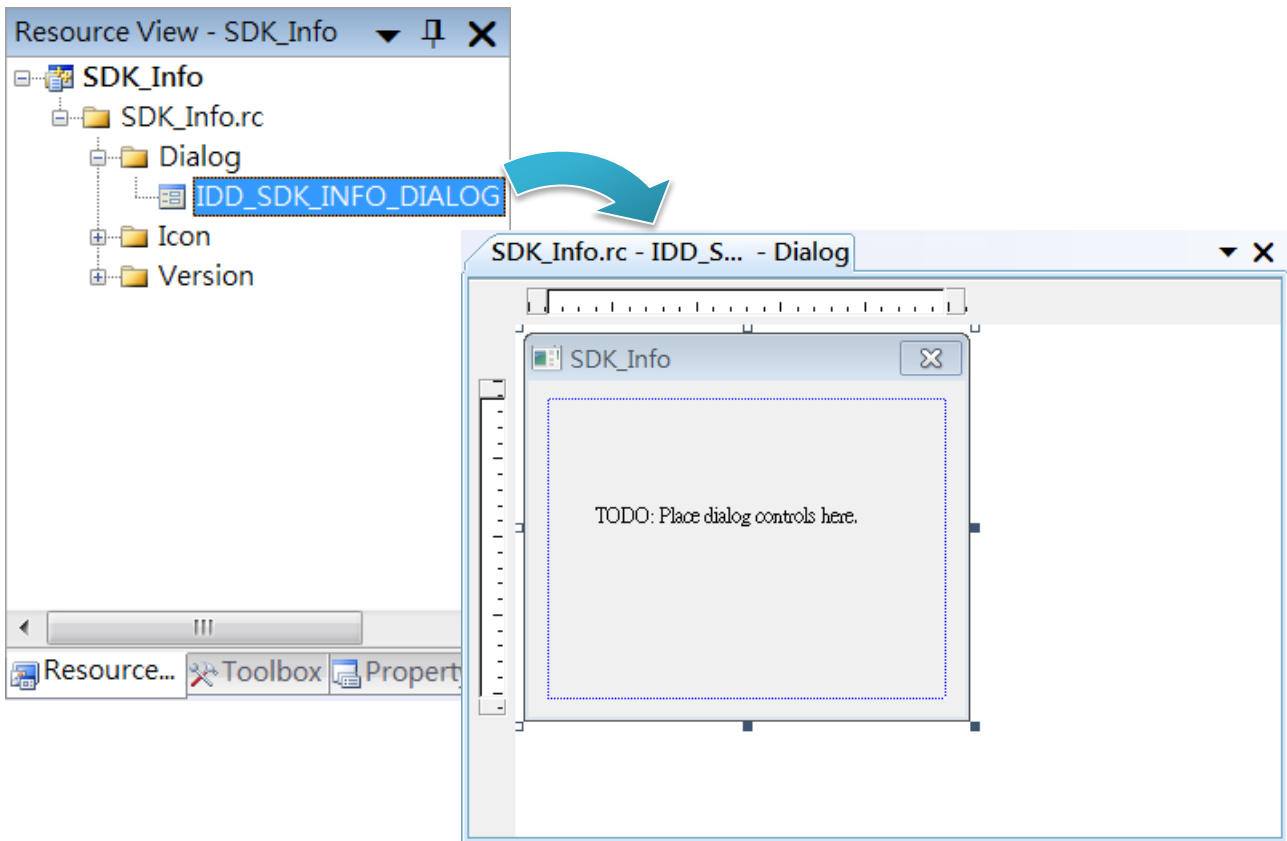

**Step 3: On the Toolbox panel, drag a Button control onto the form**

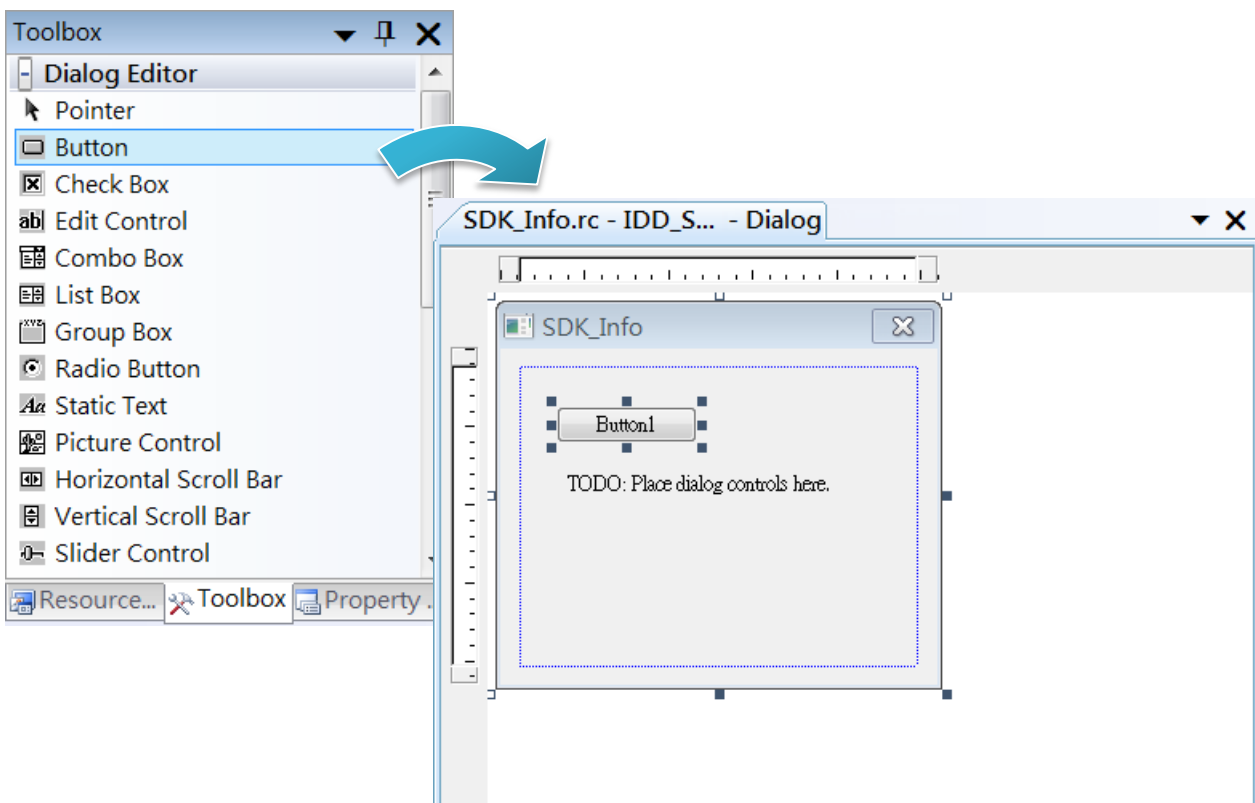

**Step 4: On the Properties panel, type Check the SDK version in the Caption field**

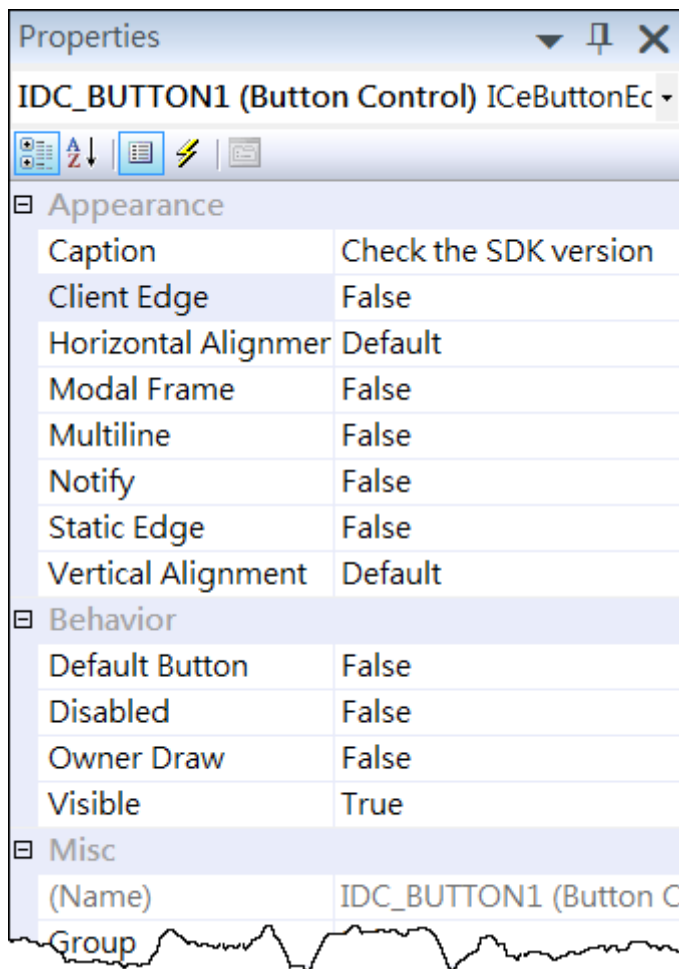

#### 4.4.5. Add the event handling for the control

You have finished the design stage of your application and are at the point when you can start adding some code to provide the program's functionality.

##### Step 1: Double-click the button on the form

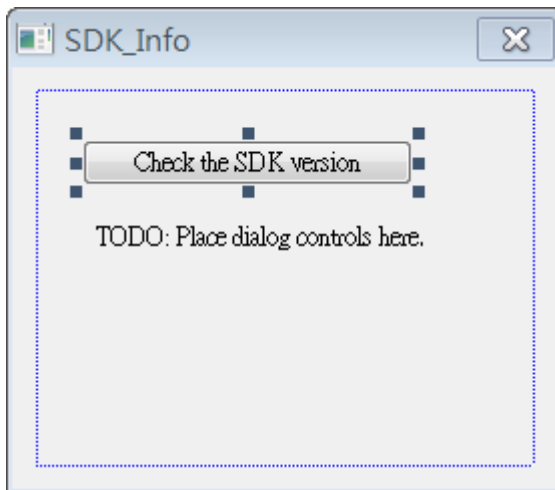

##### Step 2: Inserting the following code

```
char sdk_version[32];  
TCHAR buf[32];  
pac_GetSDKVersion(sdk_version);  
pac_AnsiToWideString(sdk_version, buf);  
MessageBox(buf,0,MB_OK);
```



## Step 2: Inserting the following code into the header area

```
#include "PACSDK.h"
```

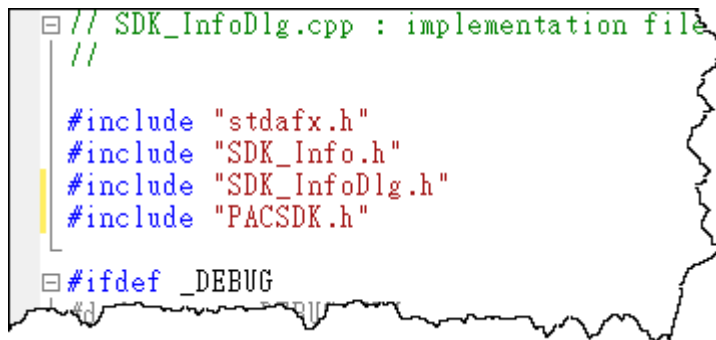

```
// SDK_InfoDlg.cpp : implementation file
//

#include "stdafx.h"
#include "SDK_Info.h"
#include "SDK_InfoDlg.h"
#include "PACSDK.h"

#ifdef _DEBUG
```

#### 4.4.6. Upload the application to VP-x231-CE7

VP-x231-CE7 supports FTP server service. You can upload files to VP-x231-CE7 or download files from a public FTP server.

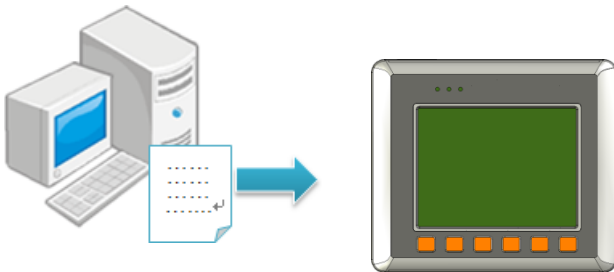

**Step 1: On the Build menu, and then click Build [Project Name]**

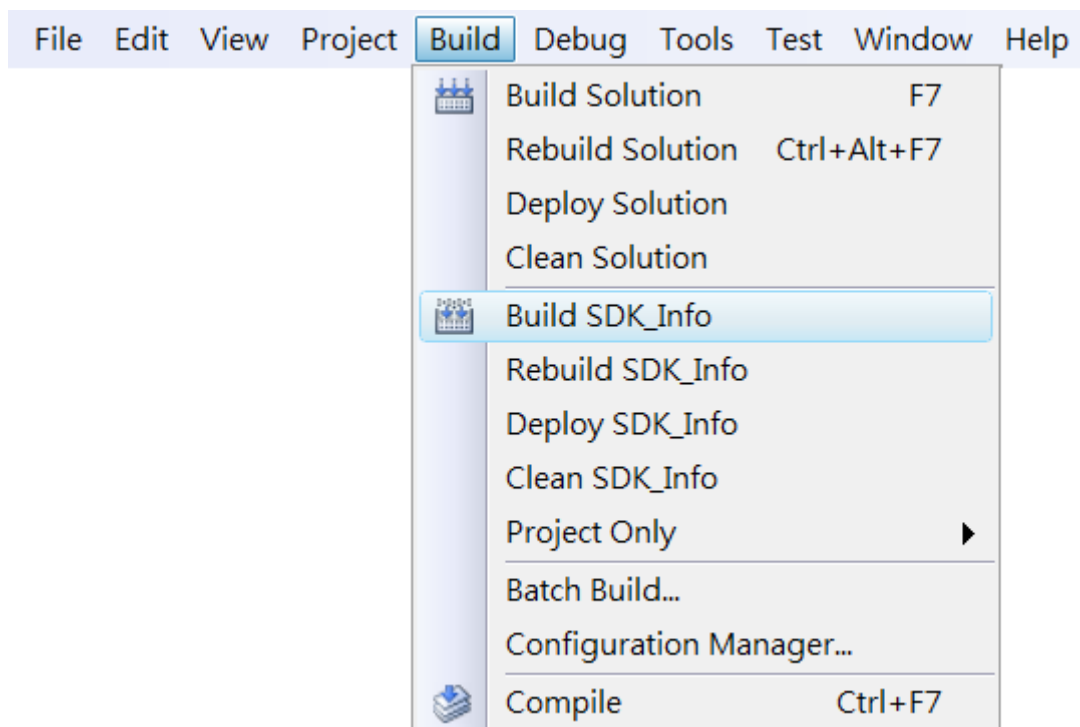

**Step 2: Open the browser and type the IP address of VP-x231-CE7**

**Step 3: Upload the application to VP-x231-CE7**

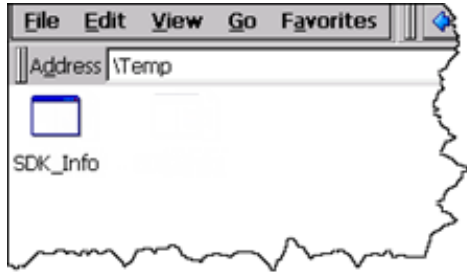

#### 4.4.7. Execute the application on VP-x231-CE7

After uploading the application to VP-x231-CE7, you can just double-click it on VP-x231-CE7 to execute it.

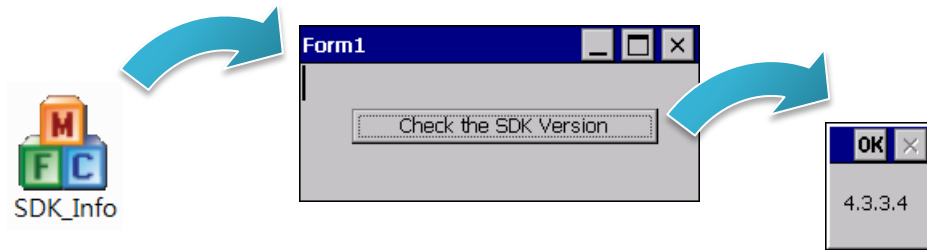

# 5. I/O Expansion Modules and SDKs Selection

This chapter describes how to select a suitable expansion I/O module and the corresponding SDK library to be used for developing programs on VP-x231-CE7.

VP-x231-CE7 provides the following I/O expansion buses:

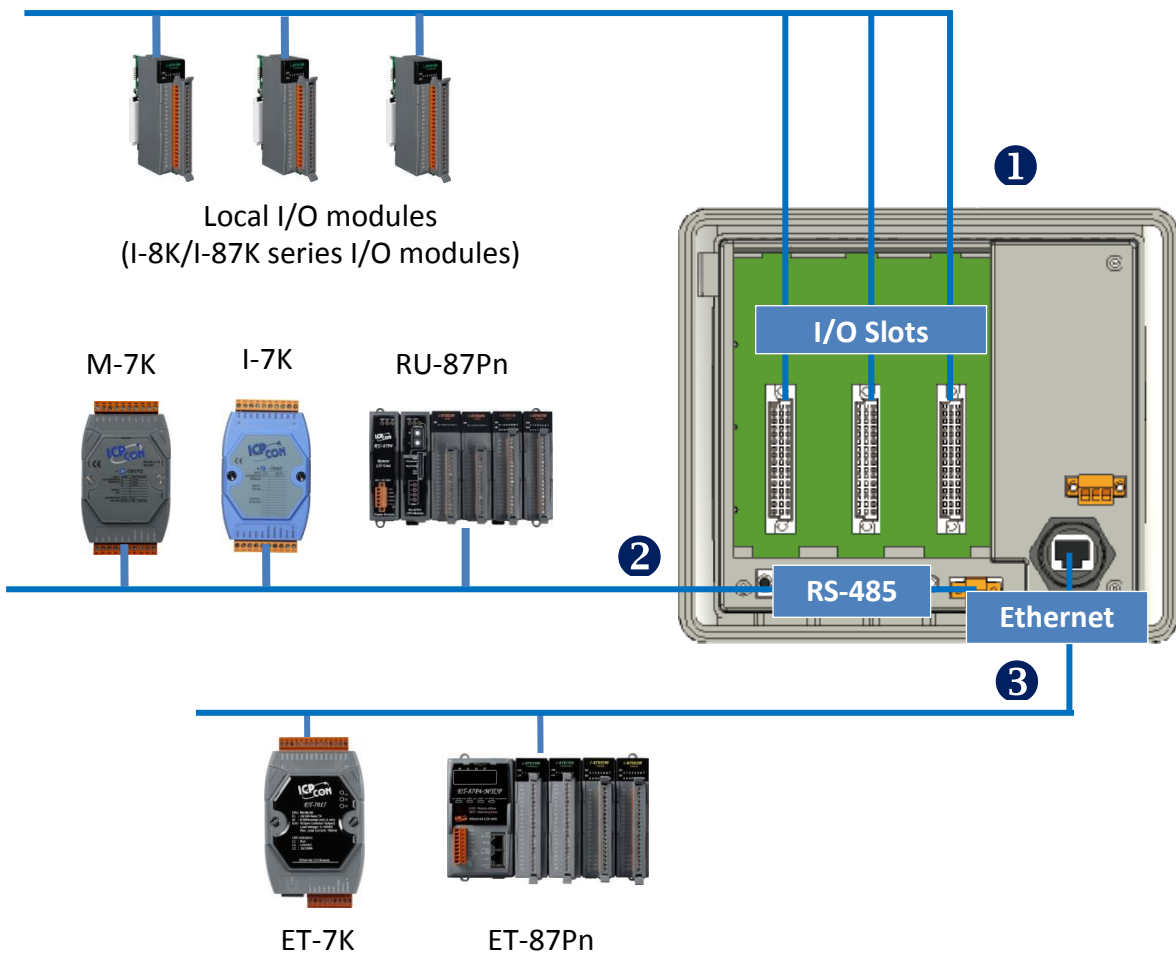



## 1. Local I/O Modules (I-8K series and I-87K series)

VP-x231-CE7 has three expansion slots that can be used to add expansion I/O modules. The expansion I/O modules can be divided into two categories: High Profile I-8K series I/O modules and High profile I-87K series I/O modules. The following indicates the appropriate SDK library to be used for I/O modules.

### ➤ General I-8K/I-87K series I/O modules

Module	Native SDK	.NET CF SDK
I-8K series	PACSDK.dll	PACNET.dll
I-87K series	PACSDK.dll	PACNET.dll
I-8K series with PWM	PACSDK_PWM.dll	PACNET.dll
I-87K series with PWM	PACSDK_PWM.dll	PACNET.dll

For full details regarding I-87K series I/O modules and its demos, please refer to:

[http://ftp.icpdas.com/pub/cd/winpac\\_am335x/demo/vp-x231/pac/applicable\\_demo\\_for\\_87k\\_module.pdf](http://ftp.icpdas.com/pub/cd/winpac_am335x/demo/vp-x231/pac/applicable_demo_for_87k_module.pdf)

### ➤ Specified I-8K series I/O modules

Module	Native SDK	.NET CF SDK
I-8014W	pac_i8014W.dll	pac_i8014WNET.dll
I-8017HW	pac_i8017HW.dll	pac_i8017HWNET.dll
I-8024W	pac_i8024W.dll	pac_i8024WNET.dll
I-8026W	pac_i8026W.dll	pac_i8026WNET.dll
I-8048W	pac_i8048W.dll	pac_i8048WNET.dll
I-8050W	pac_i8050W.dll	pac_i8050WNET.dll
I-8084W	pac_i8084W.dll	pac_i8084WNET.dll
I-8088W	pac_i8088W.dll	pac_i8088WNET.dll
I-8093W	pac_i8093W.dll	pac_i8093WNET.dll
I-87088W	PACSDK_PWM.dll	PACNET.dll

## 2. RS-485 (I-7000 series and M-7000 series)

I-7000, M-7000, RU-87Pn and high profile I-87K series modules connect to VP-x231-CE7 via a twisted-pair, multi-drop, 2-wire RS-485 network.

### ➤ I-7000 series I/O modules

Module	Native SDK	.NET CF SDK
I-7000 series	PACSDK.dll	PACNET.dll
I-7000 series with I-7088 (D)	PACSDK_PWM.dll	PACNET.dll

For full details regarding I-7000 series I/O modules and its demos, please refer to:

[http://ftp.icpdas.com/pub/cd/winpac\\_am335x/demo/vp-x231/pac/applicable\\_demo\\_for\\_7k\\_module.pdf](http://ftp.icpdas.com/pub/cd/winpac_am335x/demo/vp-x231/pac/applicable_demo_for_7k_module.pdf)

### ➤ M-7000 series I/O modules

Module	Native SDK	.NET CF SDK
M-7000 series	Modbus Demo	Modbus Demo

For more detailed information about M-7000 series modules using Modbus protocol and its demos, please refer to:

CD:\vp-x231\demo\nModbus\

### ➤ RU-87Pn + I-87K series I/O modules

Module	Native SDK	.NET CF SDK
RU-87Pn+I-87K series	PACSDK.dll	PACNET.dll

### ➤ Other Specified I/O

Module	Native SDK	.NET CF SDK
Others	PACSDK.dll	PACNET.dll

### 3. Ethernet (ET-7000 series and I-8KE4/8-MTCP)

The Ethernet I/O devices available include ET-7000 and I-8KE4/8-MTCP, and support either the DCON or the Modbus/TCP communication protocol.

Module	Native SDK	.NET CF SDK
M-7000 series	Modbus Demo	Modbus Demo
I-8KE4/8-MTCP	Modbus Demo	Modbus Demo

For more detailed information about ET-7000 and I-8KE4/8-MTCP series modules using Modbus protocol and its demos, please refer to:

[http://ftp.icpdas.com/pub/cd/winpac\\_am335x/vp-x231/demo/nmodbus/](http://ftp.icpdas.com/pub/cd/winpac_am335x/vp-x231/demo/nmodbus/)

## 6. API Resources and Demo References

This chapter provides a brief overview of PAC standard APIs and demos that have been designed for VP-x231-CE7 from the PAC SDK package.

ICP DAS provides a set of demos in different programming languages. You can examine the demo codes, which includes numerous comments, to familiarize yourself with the PAC APIs. This will allow developing your own applications quickly by modifying these demo programs.

For full usage information regarding the description, prototype and the arguments of the functions, please refer to the “PAC Standard API Manual”

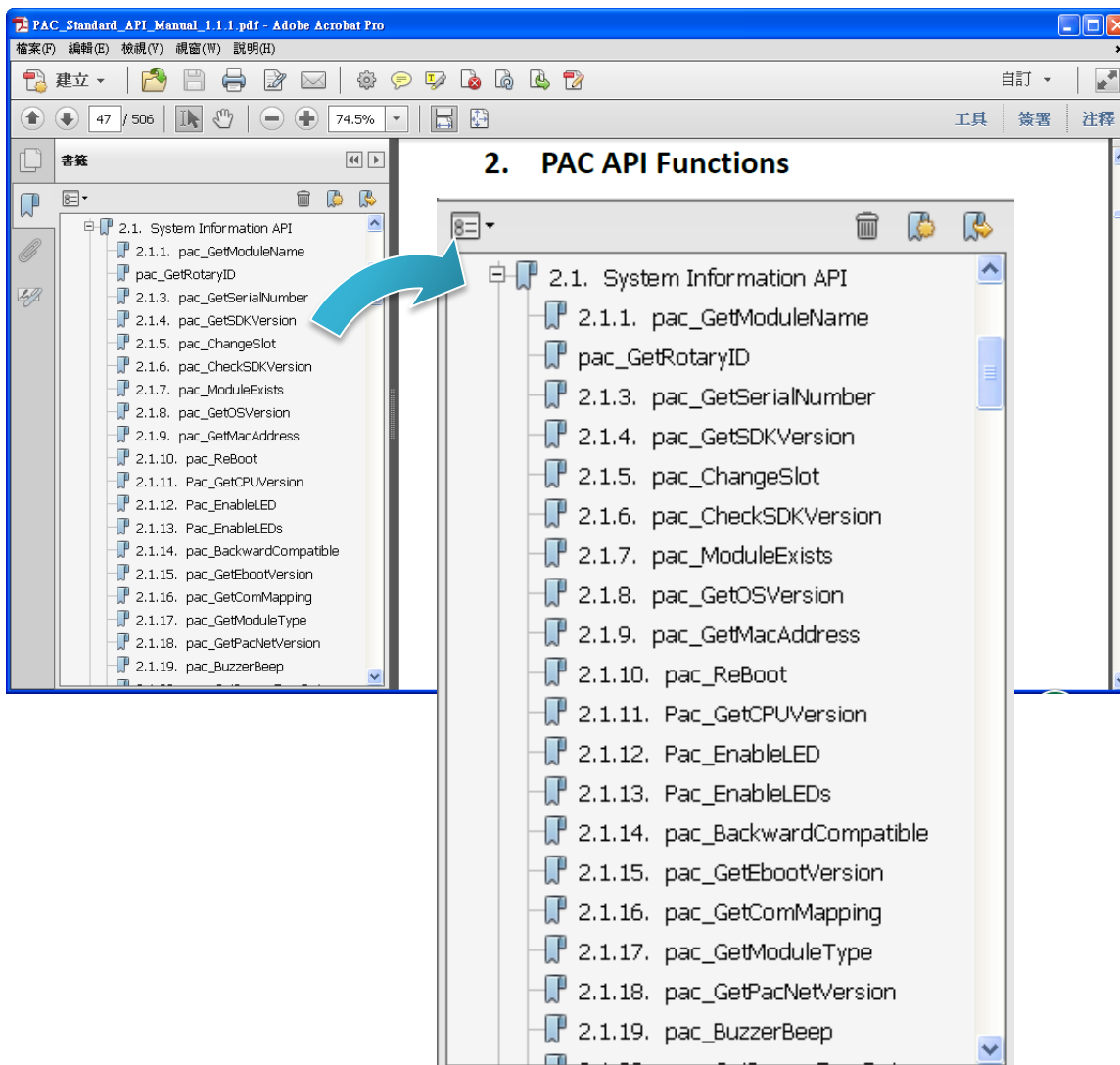

## 6.1. PAC Standard APIs for System Operation

The diagram below shows the set of each system operation API provided in the PACSDK.

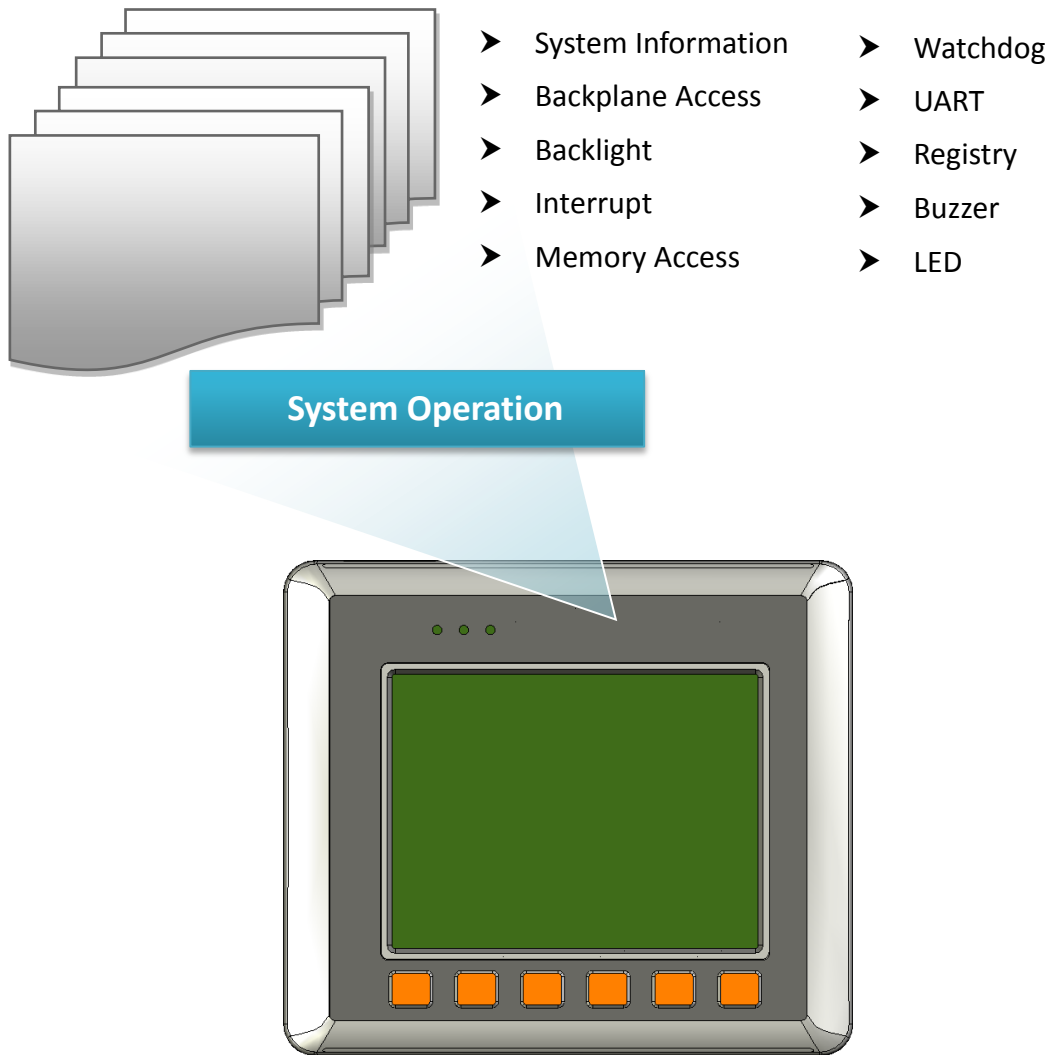

### 6.1.1. VB.NET Demos for PAC Standard APIs

The PAC SDK includes the following demos that demonstrate the use of the PAC Standard APIs in a VB.NET language environment.

The following demos can be found on the CD that was provided with the package or by downloading the latest version from ICP DAS web site.

CD:\vp-x231\Demo\PAC\Vb.net\Standard\

[http://ftp.icpdas.com/pub/cd/winpac\\_am335x/vp-x231/demo/pac/vb.net/standard/](http://ftp.icpdas.com/pub/cd/winpac_am335x/vp-x231/demo/pac/vb.net/standard/)

Folder	Demo	Explanation
system	systeminfo	Retrieves information about the OS version, CPU version, SDK version, etc.
backplane	backplaneinfo	Retrieves information about the DIP switch, backplane ID and slot count.
memoryaccess	memory	Shows how to read/write date values from/to EEPROM
	battery_backup_sram	Shows how to read or write to the battery backup
watchdog	watchdog	Displays how the watchdog operate
microsd	microsd_management	Shows how to enables/disables Micro SD
registry	registry	Shows how to read/write date values from/to registry
UART	diag	Shows how to read the name of local I/O modules via UART

## 6.1.2. C# Demos for PAC Standard APIs

The PAC SDK includes the following demos that demonstrate the use of the PAC Standard APIs in a C# language environment.

The following demos can be found on the CD that was provided with the package or by downloading the latest version from ICP DAS web site.

CD:\vp-x231\Demo\PAC\C#\Standard\

[http://ftp.icpdas.com/pub/cd/winpac\\_am335x/vp-x231/demo/pac/c%23/standard/](http://ftp.icpdas.com/pub/cd/winpac_am335x/vp-x231/demo/pac/c%23/standard/)

Folder	Demo	Explanation
buzzer	buzzer	Shows how to make a simple buzzer beep.
DeviceInformation	DeviceInformation	Retrieves information about the OS version, CPU version, SDK version, etc.
GetRotaryID	GetRotaryID	Retrieves information about the status of the rotary switch
Memory	Memory	Shows how to read/write data values from/to the EEPROM or the backplane of the SRAM
MultiRT	MultiRT	Shows how to manage the microSD
RealTimeTest	RealTimeTest	Writes the managed cod for the rich graphical user interface that does not require true real-time performance
Registry	Registry	Shows how to read/write data values from/to the registry
UART	UART	Shows how to read the name of a local I/O modules via a UART
WatchDog	WatchDog	Displays information about how to operate the watchdog

### 6.1.3. Visual C++ Demos for PAC Standard APIs

The PAC SDK includes the following demos that demonstrate the use of the PAC Standard APIs in a Visual C++ language environment.

The following demos can be found on the CD that was provided with the package or by downloading the latest version from ICP DAS web site.

CD:\vp-x231\Demo\PAC\vc2008\Standard\

[http://ftp.icpdas.com/pub/cd/winpac\\_am335x/vp-x231/demo/pac/vc2008/standard/](http://ftp.icpdas.com/pub/cd/winpac_am335x/vp-x231/demo/pac/vc2008/standard/)

Folder	Demo	Explanation
buzzer	buzzer	Shows how to make a simple buzzer beep.
DeviceInformation	DeviceInformation	Retrieves information about the OS version, CPU version, SDK version, etc.
GetRotaryID	GetRotaryID	Retrieves information about the status of the rotary switch
Memory	Memory	Shows how to read/write data values from/to the EEPROM or the backplane of the SRAM
MultiRT	MultiRT	Shows how to manage the microSD
RealTimeTest	RealTimeTest	Writes the managed cod for the rich graphical user interface that does not require true real-time performance
Registry	Registry	Shows how to read/write data values from/to the registry
UART	UART	Shows how to read the name of a local I/O modules via a UART
WatchDog	WatchDog	Displays information about how to operate the watchdog



## 6.2. PAC Standard APIs for I/O Expansion

The diagram below shows the types of the PAC IO APIs provided in the PACSDK.

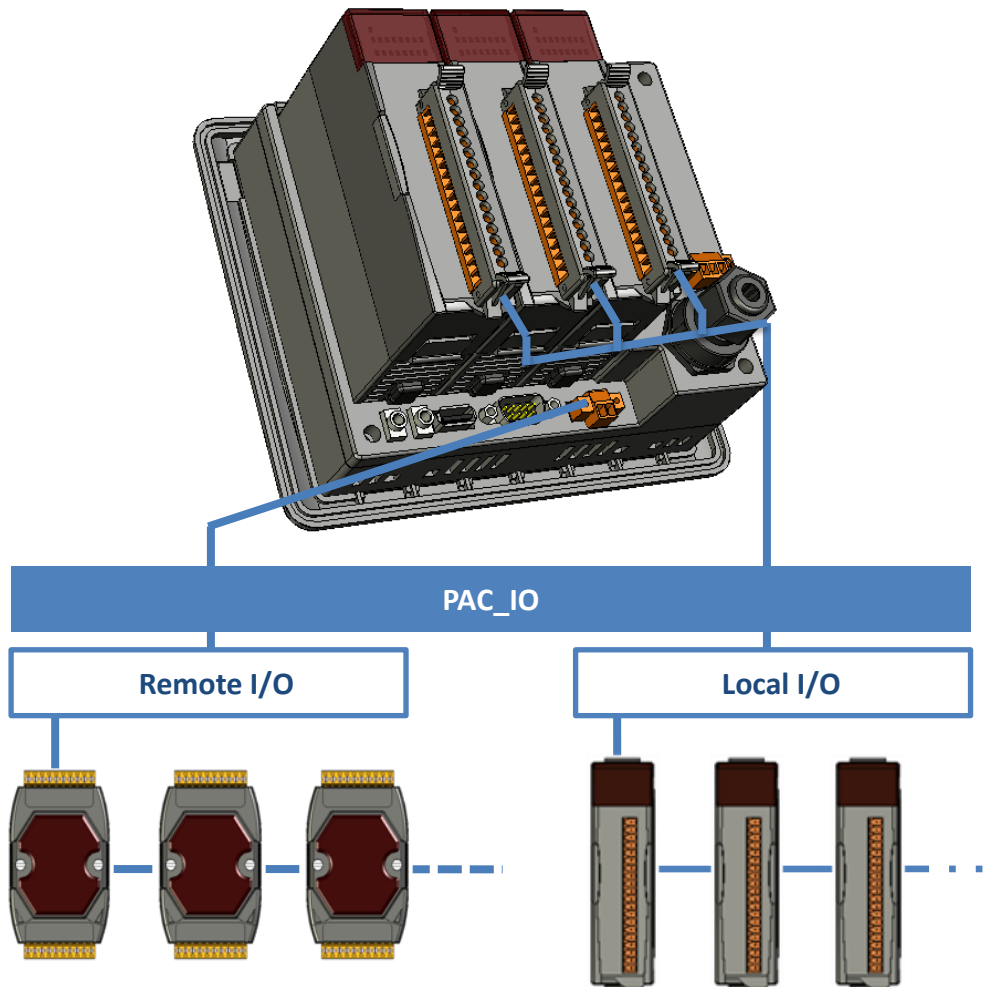

### 6.2.1. VB.NET Samples for PAC Standard APIs

The PAC SDK includes the following samples that demonstrate the use of the PAC IO APIs in a VB.NET language environment. The following samples can be found on the CD that was provided with the package or by downloading the latest version from ICP DAS web site.

For VB.NET applications, these demo programs can be obtained from:

CD:\vp-x231\Demo\PAC\Vb.net\IO\

[http://ftp.icpdas.com/pub/cd/winpac\\_am335x/vp-x231/demo/pac/vb.net/io/](http://ftp.icpdas.com/pub/cd/winpac_am335x/vp-x231/demo/pac/vb.net/io/)

Folder	Demo	Explanation
Local	find_io	Shows how to retrieve the module names and types which plugged in the VP-x231-CE7.
	8k_di	Shows how to read the DI values of DI module. This demo program is used by 8K series DI modules.
	8k_do	Shows how to write the DO values to DO module. This demo program is used by 8K series DO modules.
	8k_dio	Shows how to read the DI and the DO values of the DIO module. This demo program is used by 8K series DIO modules.
	87k_basic	Shows how to send/receive a command/response application. This demo program is used by 87K series modules.
	87K_demo	Shows how use UART API and the IO modules located as slots. This demo program is used by 87K series modules.
	87k_ai	Shows how to read the AI values of AI module. This demo program is used by 87K series AI modules.
	87k_ao	Shows how to write the AO values to AO module. This demo program is used by 87K series AO modules.
	87k_di	Shows how to read the DI values of DI module. This demo program is used by 87K series DI modules.
	87k_do	Shows how to write the DO values to DO module. This demo program is used by 87K series DO modules.
	87k_dio	Shows how to read the DI and the DO values of the DIO module. This demo program is used by 87K series DIO modules.
Remote	7k87k_basic	Shows how to send/receive a command/response application. This demo program is used by 7K or 87K series AI modules which connected through a COM port.
	7k87k_ai	Shows how to read the AI values of AI module. This demo program is used by 7K or 87K series

Folder	Demo	Explanation
		AI modules which connected through a COM port.
	7k87k_ao	Shows how to write the AO values to AO module. This demo program is used by 7K or 87K series AI modules which connected through a COM port.
	7k87k_di	Shows how to read the DI values of DI module. This demo program is used by 7K or 87K series AI modules which connected through a COM port.
	7k87k_do	Shows how to write the DO values to DO module. This demo program is used by 7K or 87K series AI modules which connected through a COM port.
	7k87k_dio	Shows how to read the DI and the DO values of the DIO module. This demo program is used by 7K or 87K series AI modules which connected through a COM port.

## 6.2.2. C# Samples for PAC Standard APIs

The PAC SDK includes the following samples that demonstrate the use of the PAC IO APIs in a C# language environment. The following samples can be found on the CD that was provided with the package or by downloading the latest version from ICP DAS web site.

For C# applications, these demo programs can be obtained from:

CD:\vp-x231\Demo\PAC\C#\IO\

[http://ftp.icpdas.com/pub/cd/winpac\\_am335x/vp-x231/demo/pac/c%23/io/](http://ftp.icpdas.com/pub/cd/winpac_am335x/vp-x231/demo/pac/c%23/io/)

Folder	Demo	Explanation
Local	find_io	Shows how to retrieve the module names and types which plugged in the VP-x231-CE7.
	8k_di	Shows how to read the DI values of DI module. This demo program is used by 8K series DI modules.
	8k_do	Shows how to write the DO values to DO module. This demo program is used by 8K series DO modules.
	8k_dio	Shows how to read the DI and the DO values of the DIO module. This demo program is used by 8K series DIO modules.
	87k_basic	Shows how to send/receive a command/response application. This demo program is used by 87K series modules.
	87K_demo	Shows how use UART API and the IO modules located as slots. This demo program is used by 87K series modules.
	87k_ai	Shows how to read the AI values of AI module. This demo program is used by 87K series AI modules.
	87k_ao	Shows how to write the AO values to AO module. This demo program is used by 87K series AO modules.
	87k_di	Shows how to read the DI values of DI module. This demo program is used by 87K series DI modules.
	87k_do	Shows how to write the DO values to DO module. This demo program is used by 87K series DO modules.
	87k_dio	Shows how to read the DI and the DO values of the DIO module. This demo program is used by 87K series DIO modules.
Remote	7k87k_basic	Shows how to send/receive a command/response application. This demo program is used by 7K or 87K series AI modules which connected through a COM port.
	7k87k_ai	Shows how to read the AI values of AI module. This demo program is used by 7K or 87K series

Folder	Demo	Explanation
		AI modules which connected through a COM port.
	7k87k_ao	Shows how to write the AO values to AO module. This demo program is used by 7K or 87K series AI modules which connected through a COM port.
	7k87k_di	Shows how to read the DI values of DI module. This demo program is used by 7K or 87K series AI modules which connected through a COM port.
	7k87k_do	Shows how to write the DO values to DO module. This demo program is used by 7K or 87K series AI modules which connected through a COM port.
	7k87k_dio	Shows how to read the DI and the DO values of the DIO module. This demo program is used by 7K or 87K series AI modules which connected through a COM port.

### 6.2.3. Visual C++ Samples for PAC Standard APIs

The PAC SDK includes the following samples that demonstrate the use of the PAC IO APIs in a Visual C++ language environment. The following samples can be found on the CD that was provided with the package or by downloading the latest version from ICP DAS web site.

For Visual C++ applications, these demo programs can be obtained from:

CD:\vp-x231\Demo\PAC\Vc2008\IO\

[http://ftp.icpdas.com/pub/cd/winpac\\_am335x/vp-x231/demo/pac/vc2008/io/](http://ftp.icpdas.com/pub/cd/winpac_am335x/vp-x231/demo/pac/vc2008/io/)

Folder	Demo	Explanation
Local	find_io	Shows how to retrieve the module names and types which plugged in the VP-x231-CE7.
	8k_di	Shows how to read the DI values of DI module. This demo program is used by 8K series DI modules.
	8k_do	Shows how to write the DO values to DO module. This demo program is used by 8K series DO modules.
	8k_dio	Shows how to read the DI and the DO values of the DIO module. This demo program is used by 8K series DIO modules.
	87k_basic	Shows how to send/receive a command/response application. This demo program is used by 87K series modules.
	87K_demo	Shows how use UART API and the IO modules located as slots. This demo program is used by 87K series modules.
	87k_ai	Shows how to read the AI values of AI module. This demo program is used by 87K series AI modules.
	87k_ao	Shows how to write the AO values to AO module. This demo program is used by 87K series AO modules.
	87k_di	Shows how to read the DI values of DI module. This demo program is used by 87K series DI modules.
	87k_do	Shows how to write the DO values to DO module. This demo program is used by 87K series DO modules.
	87k_dio	Shows how to read the DI and the DO values of the DIO module. This demo program is used by 87K series DIO modules.
Remote	7k87k_basic	Shows how to send/receive a command/response application. This demo program is used by 7K or 87K series AI modules which connected through a COM port.
	7k87k_ai	Shows how to read the AI values of AI module. This demo program is used by 7K or 87K series

Folder	Demo	Explanation
		AI modules which connected through a COM port.
	7k87k_ao	Shows how to write the AO values to AO module. This demo program is used by 7K or 87K series AI modules which connected through a COM port.
	7k87k_di	Shows how to read the DI values of DI module. This demo program is used by 7K or 87K series AI modules which connected through a COM port.
	7k87k_do	Shows how to write the DO values to DO module. This demo program is used by 7K or 87K series AI modules which connected through a COM port.
	7k87k_dio	Shows how to read the DI and the DO values of the DIO module. This demo program is used by 7K or 87K series AI modules which connected through a COM port.

## 7. VP-x231-CE7 Updates

This chapter provides a guided tour that demonstrates the steps needed to update the VP-x231-CE7 OS and SDKs.

ICP DAS will continue to add additional features to VP-x231-CE7 SDK and OS in the future, so we advise you to periodically check the ICP DAS web site for the latest updates.

The file location of the OS and SDK

Both the files of OS updates and SDK updates can be found on the CD that was provided with the package or by downloading the latest version from ICP DAS web site.

CD:\vp-x231\  
http://ftp.icpdas.com/pub/cd/winpac\_am335x/vp-x231/

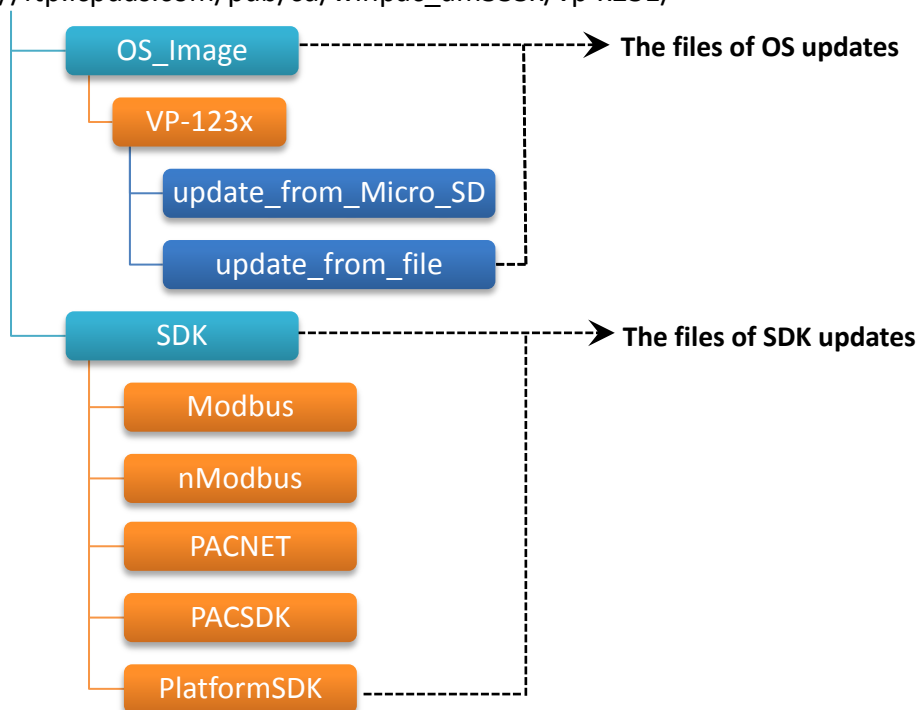



## 7.1. OS Updates

The latest version of the VP-x231-CE7 OS image can be found separately on the CD that was provided with the package or by downloading the latest version from ICP DAS web site.

CD:\vp-x231\  
[http://ftp.icpdas.com/pub/cd/winpac\\_am335x/vp-x231/](http://ftp.icpdas.com/pub/cd/winpac_am335x/vp-x231/)

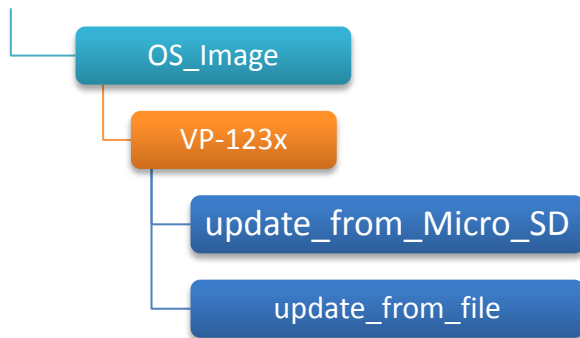

There are two ways to update the OS:

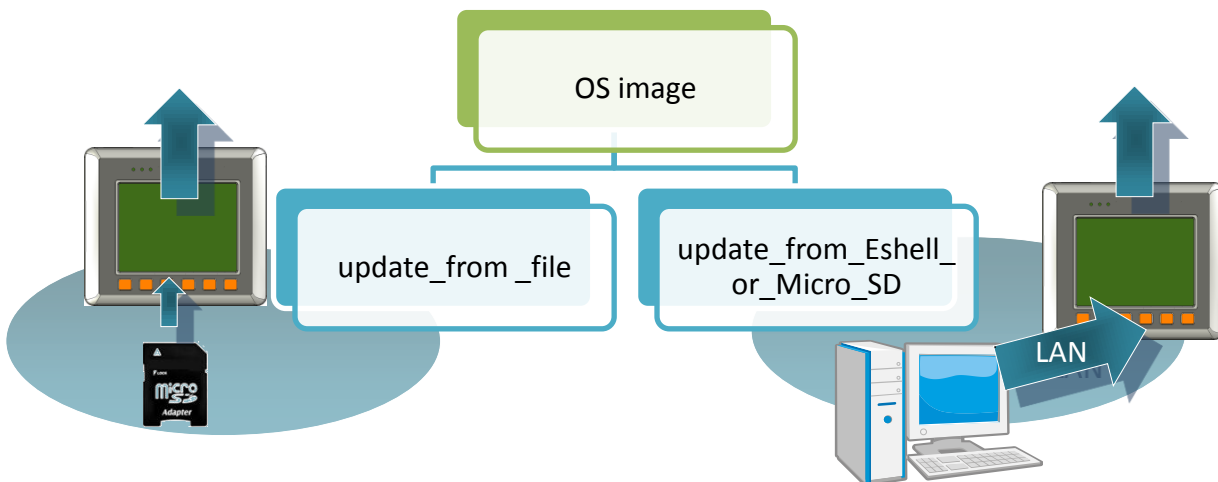

1. OS updates from eshell (Please refer to section 7.1.1)  
(We recommend that you use this one for more quicker and easier to update)
2. OS updates from micro\_SD (Please refer to section 7.1.2)

### 7.1.1. OS Updates from Eshell

By default, the OS update is updated via a LAN.  
Before updating the OS, make sure the LAN is connected to PC.

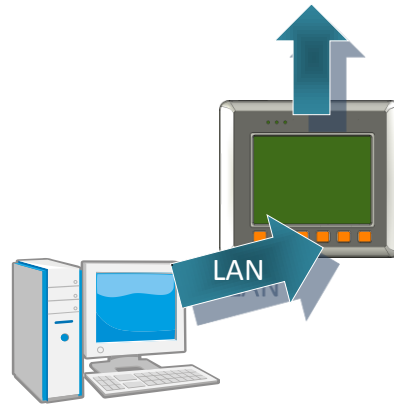

#### Step 1: Get the latest version of the installation package file and then unzip it

The latest version of the installation package file can be found from ICP DAS web site.

[http://ftp.icpdas.com/pub/cd/winpac\\_am335x/vp-x231/os\\_image/vp-123x/update\\_from\\_eshell\\_or\\_micro\\_sd](http://ftp.icpdas.com/pub/cd/winpac_am335x/vp-x231/os_image/vp-123x/update_from_eshell_or_micro_sd)

#### Step 2: Run the registry clear.exe

The registry.exe can be found on the CD that was provided with the package or by downloading the latest version from ICP DAS web site.

CD:\VP-x231\PC\_Tools\Eshell

[http://ftp.icpdas.com/pub/cd/winpac\\_am335x/vp-x231/pc\\_tools/eshell/](http://ftp.icpdas.com/pub/cd/winpac_am335x/vp-x231/pc_tools/eshell/)

#### Step 3: Place the rotary switch in position 3, OS update mode

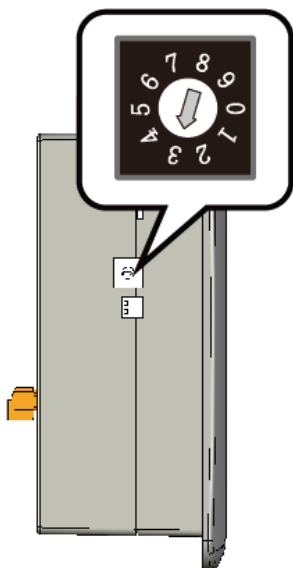

#### Step 4: Run the ESHELL.exe, and then restart the VP-x231-CE7-CE7

The ESHELL.exe can be found on the CD that was provided with the package or by downloading the latest version from ICP DAS web site.



CD:\VP-x231\PC\_Tools\Eshell

[http://ftp.icpdas.com/pub/cd/winpac\\_am335x/vp-x231/pc\\_tools/eshell/](http://ftp.icpdas.com/pub/cd/winpac_am335x/vp-x231/pc_tools/eshell/)

#### Step 5: Select the device which you want to update the OS image, and then click OK

Select the device name which you want to update the OS image from the list.

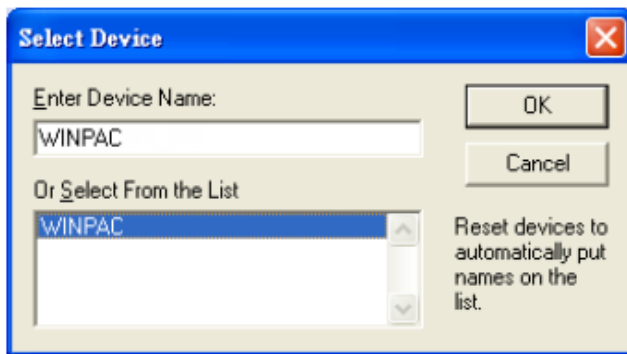

#### Step 6: Select the latest version of the OS image file

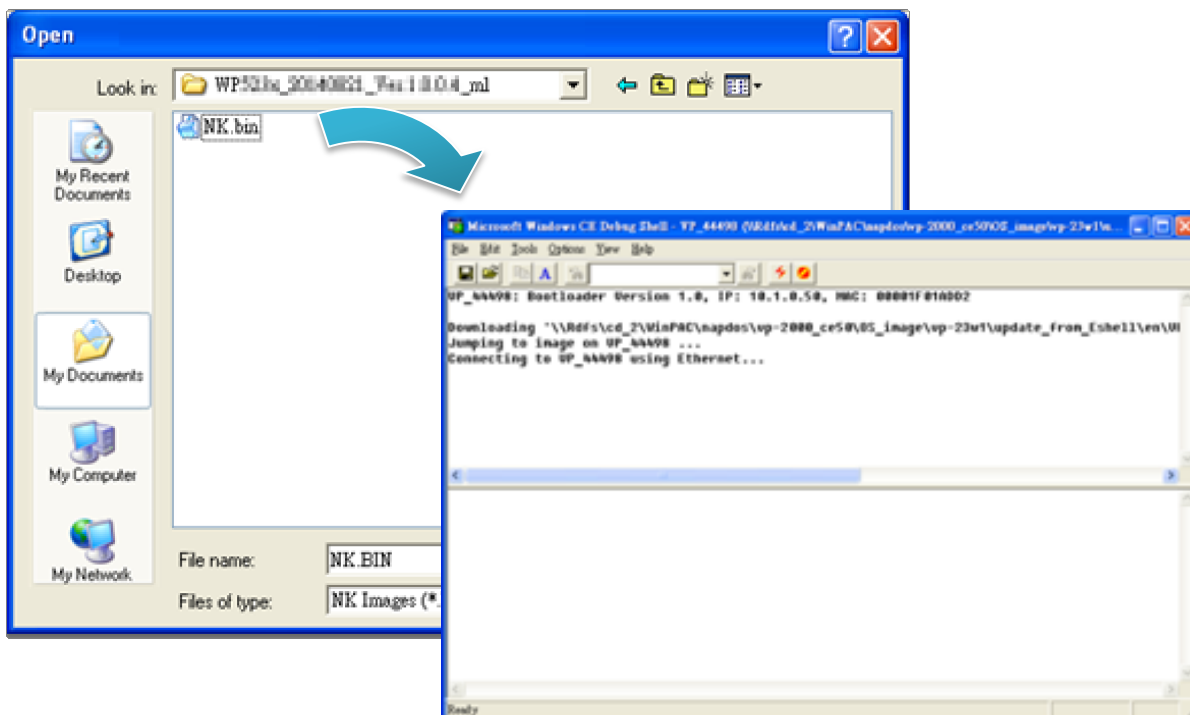

**Step 7: Once the procedure is completed, the “Warning !” dialog box will appear as below shown, then turn the rotary switch in position 0, normal mode**

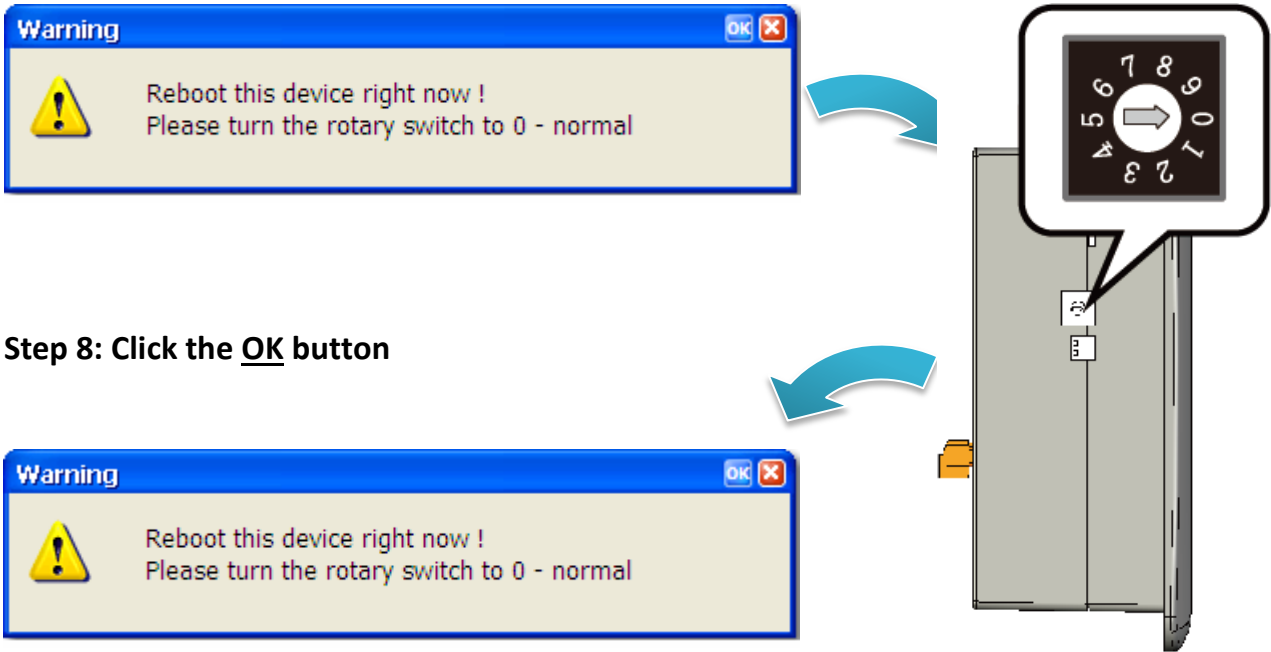

**Step 8: Click the OK button**

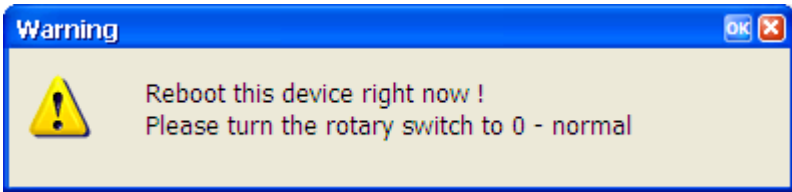

**Step 9: Check the OS version**

Run the PAC Utility, and then select the Device Information tab to check the current OS version.

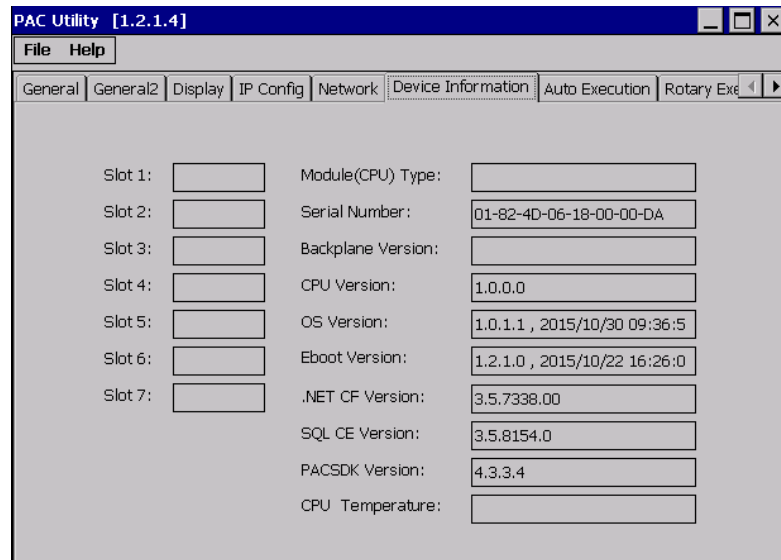

### 7.1.2. OS updates using micro\_SD

The microSD card can be used to reinstall the VP-x231-CE7 OS image to factory default settings in the event of the VP-x231-CE7 failure.

#### Step 1: Get the latest version of the installation package file, then unzip the file, and then copy them to microSD card

The latest version of the installation package file can be found from ICP DAS web site.

[http://ftp.icpdas.com/pub/cd/winpac\\_am335x/vp-x231/os\\_image/vp-123x/update\\_from\\_eshell\\_or\\_micro\\_sd/](http://ftp.icpdas.com/pub/cd/winpac_am335x/vp-x231/os_image/vp-123x/update_from_eshell_or_micro_sd/)

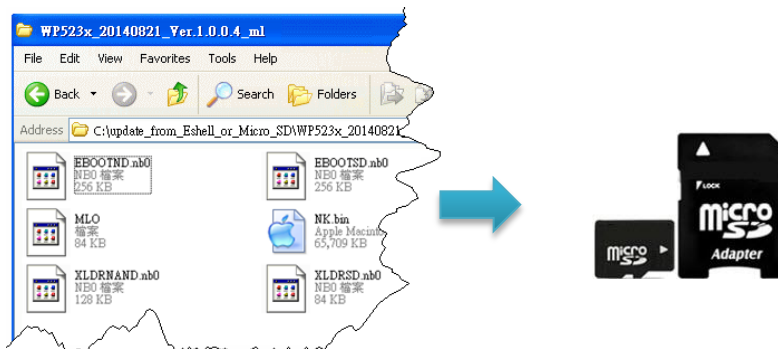

#### Step 2: Plug the microSD card into microSD slot

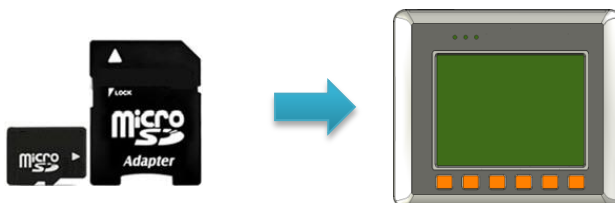

**Step 3: Turn the rotary switch in position 5, OS update mode**

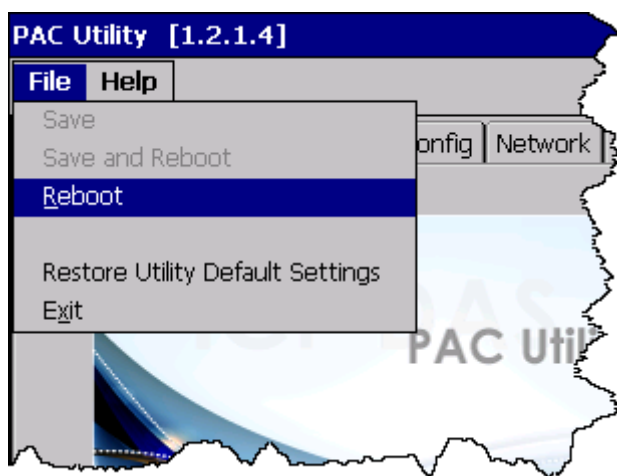
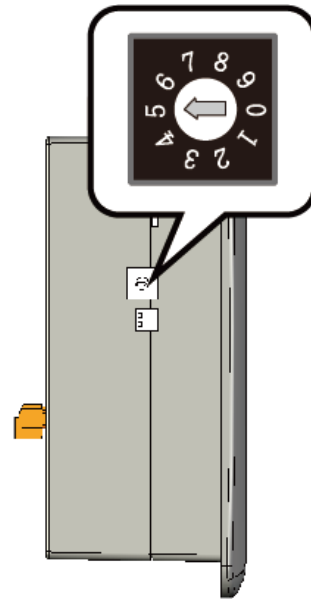

**Step 4: Reboot the VP-x231-CE7**



**Step 5: Wait a few minutes for the following desktop to be displayed**

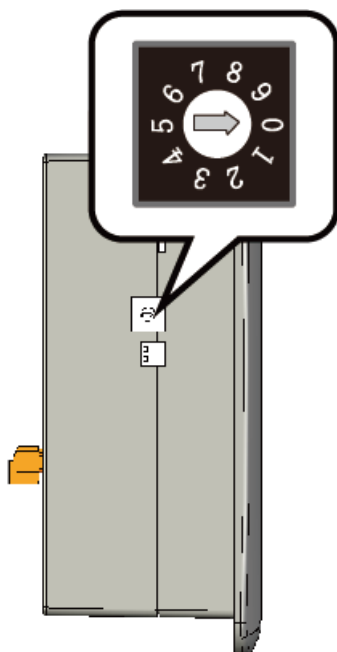

**Step 6: Turn the rotary switch in position 0, normal mode**

### Step 7: Reboot the VP-x231-CE7

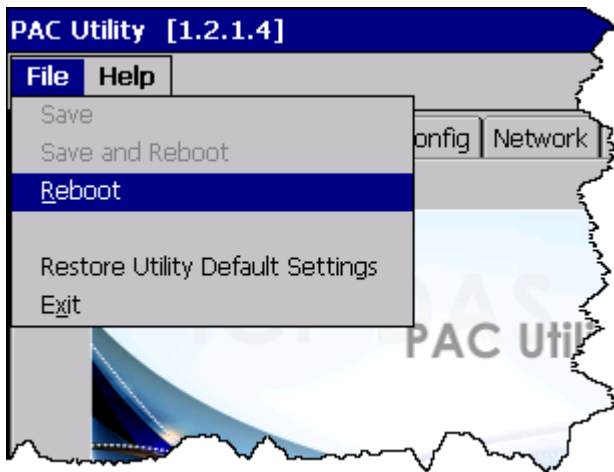

### Step 8: Check the OS version

Run the PAC Utility, and then select the Device Information tab to check the current OS version.

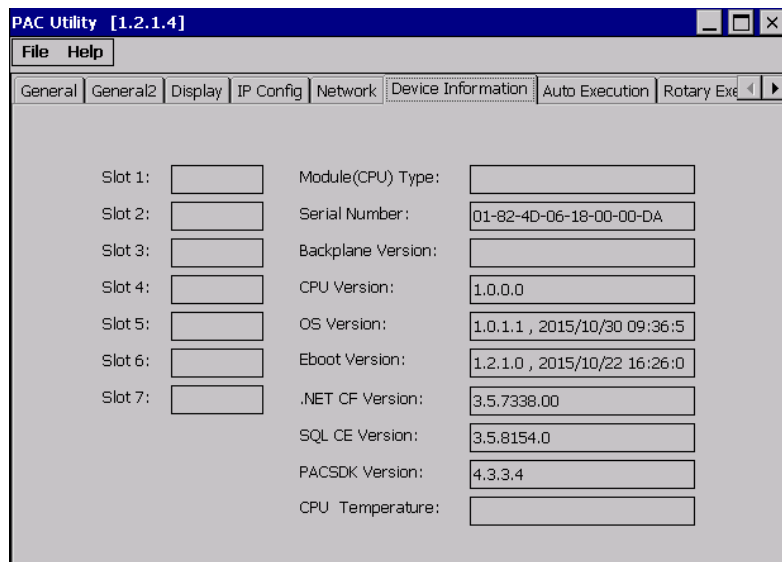

## 7.2. SDK Updates

SDK update is a part of the VP-x231-CE7 update services to provide additional and more efficient features and functionality for VP-x231-CE7 operating system.

The SDK update files can be found separately on the CD that was provided with the package or by downloading the latest version from ICP DAS web site.

CD:\vp-x231\SDK\

[http://ftp.icpdas.com/pub/cd/winpac\\_am335x/vp-x231/sdk/](http://ftp.icpdas.com/pub/cd/winpac_am335x/vp-x231/sdk/)

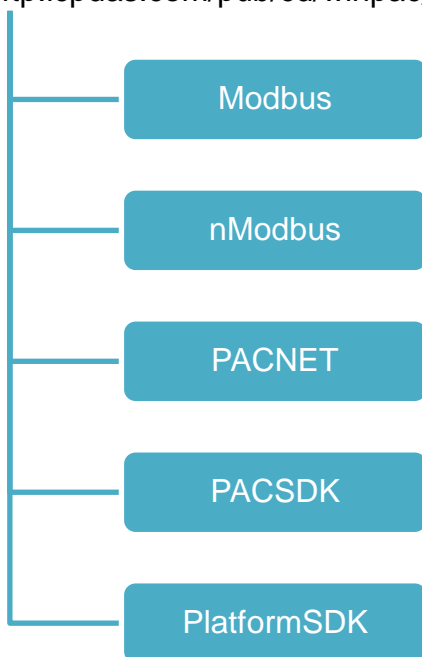



### 7.2.1. SDK Updates for VB.NET or C#

The SDK can be updated by changing the SDK file.

#### **Step 1: Get the latest version of the PACNET.dll file**

The latest version of the PACNET.dll file can be obtained from ICP DAS web site.

[http://ftp.icpdas.com/pub/cd/winpac\\_am335x/vp-x231/sdk/pacnet/](http://ftp.icpdas.com/pub/cd/winpac_am335x/vp-x231/sdk/pacnet/)

#### **Step 2: Copy the latest version of PACNet.dll file to PC and VP-x231-CE7**

The PACNET.dll file on PC can be placed anywhere only the solution can reference it.

The PACNET.dll file on VP-x231-CE7 is located at the same directory as the .exe file.

## 7.2.2. SDK Updates for VB.NET or Visual C++

The SDK can be updated by changing the SDK file.

### Step 1: Get the latest version of the VC++ components

The latest version of the VC++ components can be obtained from:

[http://ftp.icpdas.com/pub/cd/winpac\\_am335x/vp-x231/sdk/pacsdk/](http://ftp.icpdas.com/pub/cd/winpac_am335x/vp-x231/sdk/pacsdk/)

### Step 2: Copy the latest version of header files and libraries to PC

The header files are located at:

C:\Program Files\Windows CE Tools\SDKs\AM335x\_WINCE7\_SDK\Include\Armv4i

The libraries are located at:

C:\Program Files\Windows CE Tools\SDKs\AM335x\_WINCE7\_SDK\Lib\ARMv4I

### Step 3: Copy the latest version of DLL files to VP-x231-CE7

The DLL files are located at:

\System\_Disk\ICPDAS\System

## 8. ViewPAC Download Center

This chapter provides a brief introduction of the ViewPAC download center.

ViewPAC has a download center where you can access the latest version of the software, tools, demo programs, and related information.

The ViewPAC Download Center can be found at:

[http://www.icpdas.com/root/support/download/pac/vp-x23x-ce7/vp-x23x-ce7\\_download\\_os\\_images.html](http://www.icpdas.com/root/support/download/pac/vp-x23x-ce7/vp-x23x-ce7_download_os_images.html)

### *VP-x23x Download Center*

**Note:**

When you download the software programs, you should notice if the programs conform to your machine. Before you download any program, please read the notes of each online program first to avoid the confused situation.

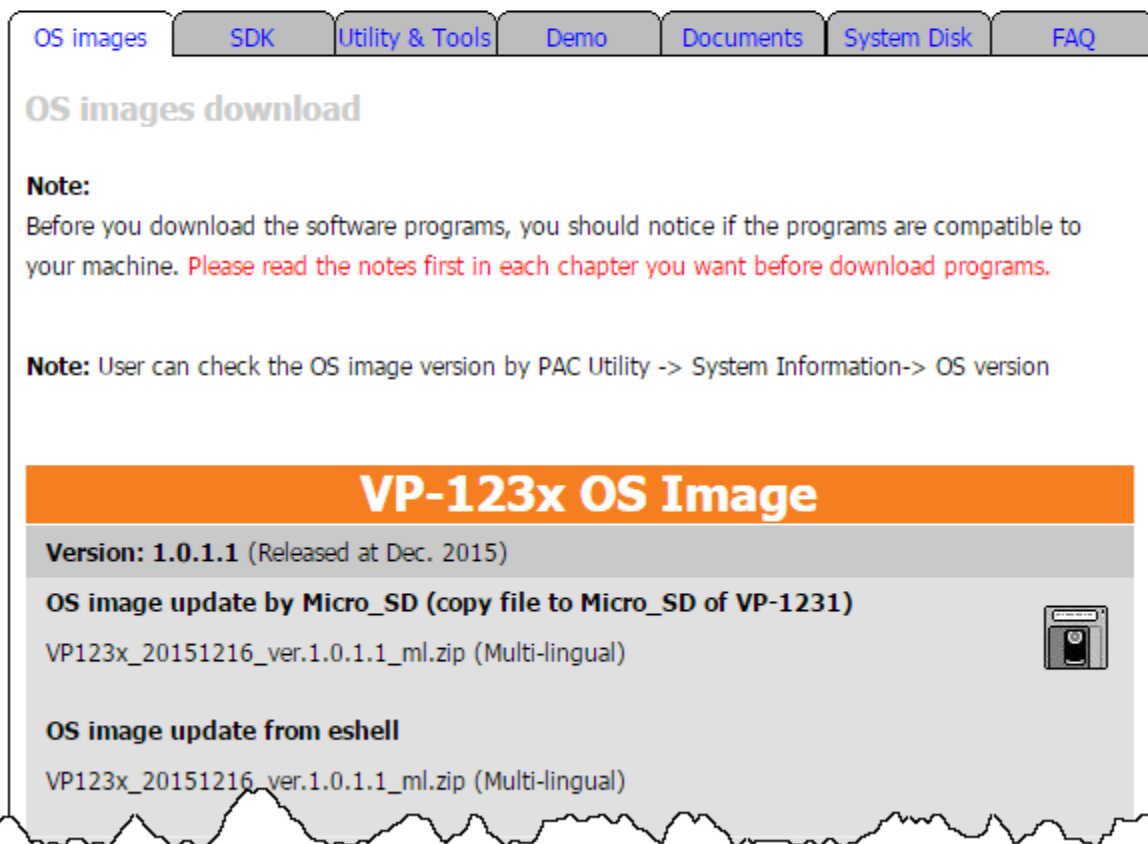

The screenshot shows a web interface with a navigation bar at the top containing tabs for OS images, SDK, Utility & Tools, Demo, Documents, System Disk, and FAQ. The main content area is titled "OS images download" and includes a note about compatibility. Below this, there is a section for "VP-123x OS Image" with a version of 1.0.1.1 (Released at Dec. 2015). Two options are listed: "OS image update by Micro\_SD (copy file to Micro\_SD of VP-1231)" and "OS image update from eshell", both offering a file named "VP123x\_20151216\_ver.1.0.1.1\_ml.zip (Multi-lingual)". A small icon of a Micro SD card is shown next to the first option. The bottom of the screenshot has a decorative torn paper effect.

## Tips & How to

This chapter provides tips and a guided tour on using and maintaining the VP-x231-CE7.

## A. I-8K and I-87K I/O Modules

There are 3 slots to expand local I/O. And the I/O modules can be parallel bus type (high profile I-8K series) and serial bus type (high profile I-87K series).

The difference between them is as follows:

Functions	I-8K Series	I-87K Series
Communication interface	Parallel bus	Serial bus
Protocol	-	DCON
Communication speed	Fast	Slow
DI latched function	-	Yes
Counter input (for digital input module)	-	Yes (100 Hz)
Power on value	-	Yes
Safe value	-	Yes
Programmable slew-rate for AO module	-	Yes

## B. How to Change the Battery

RTC and SRAM data is retained by two Li batteries, which can supply continuous power to the 512 KB SRAM to ensure that the data is retained for 5 years. The dual-battery design has the added function of preventing data from being lost while replacing the battery.

The following figures show the location of the two batteries installed in the ViewPAC.

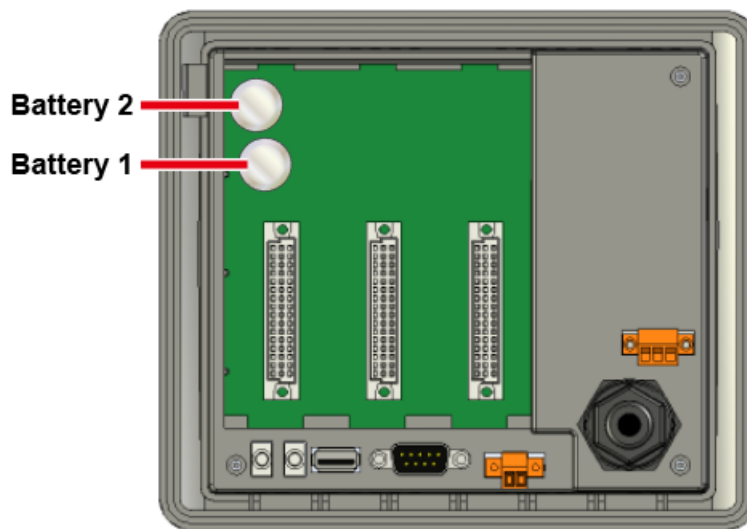

### To checking the current battery power:

1. Run the PAC utility and check the Battery1 and Battery2 fields that display the current status of each battery. Refer to Section 3.1.3. PAC Utility - Property Tab - General for more details. If the power level for either of the batteries is low, both should be replaced.
2. When programming this, call the `pac_GetBatteryLevel()` API function in the PACSDK.dll to check whether the battery power is low. When the power for either of the batteries is low, it's recommended that the battery is replaced immediately, otherwise the data on the SRAM may be lost or RTC time will be reset.

### Tips & Warnings



The battery initial voltage should be around 2.8 V to 3.0 V. When lower than 2.1 V, the PAC Utility will show the low power warning. When lower than 1.5 V, the data in the RTC (real time clock) and 512 KB SDRAM will be lost.

### To replace the battery without losing data:

1. Power off the ViewPAC.
2. Remove the slot cover and I/O socket inserted into the slot.
3. First, remove the battery that is running low on power from the battery holder.
4. Insert a new battery.
5. Remove the other battery.
6. Insert a new battery.

---

#### Tips & Warnings



1. If the battery power for only one of the two batteries is low, you can use this method to replace the battery so as to prevent data from being lost. (In the circuit design for the ViewPAC series, when the power for one of the batteries is low, it will automatically switch to the other one to ensure continued battery power)
  2. If both batteries have run out of power, the data will be lost, even if this method is used to replace the batteries.
- 

### To replace the battery 1/2:

To back up the SRAM data using the backup utility before replacing the battery. Refer to Section “Using the Backup Utility to back up the settings and files” to back up and restore the SRAM data.

1. Run the backup utility to back up the SRAM data.
2. Power off the ViewPAC.
3. Remove the slot cover and I/O socket inserted into the slot.
4. Remove both batteries from their respective holders.
5. Insert a new battery.
6. Power on the ViewPAC.
7. Run the backup utility to restore the SRAM data.
8. Set the RTC time.

## C. How to Online Debug the VP-x231-CE7 Program

Here are step by step instructions on how to online debug the VP-x231-CE7 program.

### Tips & Warnings



Before starting online debug the VP-x231-CE7 program, make sure that the VP-x231-CE7 SDK has been installed correctly.

For more information on how to install the VP-x231-CE7 SDK, please refer to 4.1.2. Installing the VP-x231-CE7 SDK.

### Step 1: Copy the following files to the \System\_Disk\icpdas\system on the VP-x231-CE7

By default, these files are located on the development computer at C:\Program Files\Common Files\Microsoft Shared\CoreCon\1.0\Target\wce400\<CPU>.

- clientshutdown.exe
- CMAccept.exe
- ConmanClient2.exe
- eDbgTL.dll
- TcpConnectionA.dll

### Step 2: Run the ConmanClient2.exe and then CMAccept.exe on the VP-x231-CE7

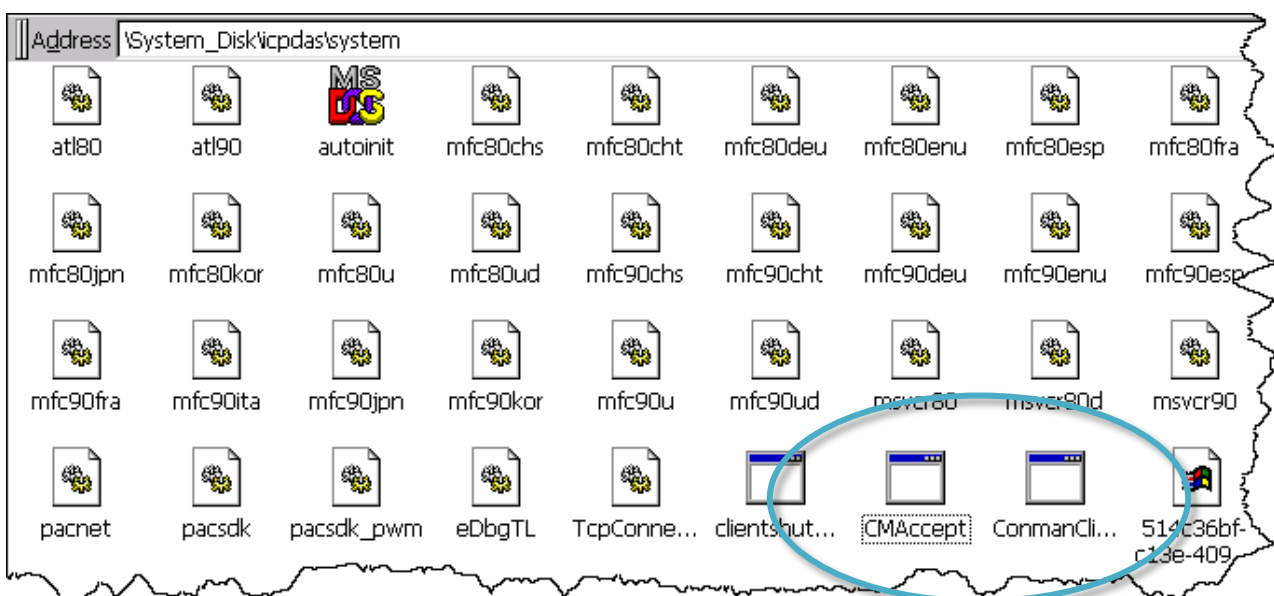



**Step 3: On the Tools menu, click the Options**

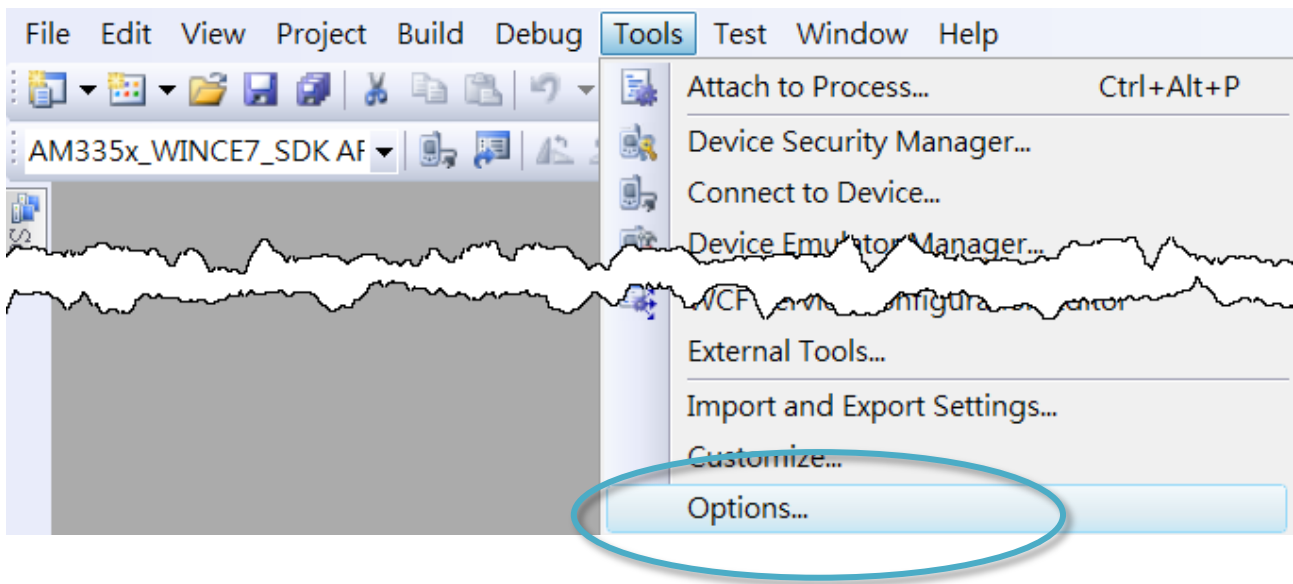

**Step 4: In the left pane, expand Device Tools node and select Devices**

**Step 5: In the Show devices for platform:, select AM335x\_WINCE7\_SDK and then click Properties**

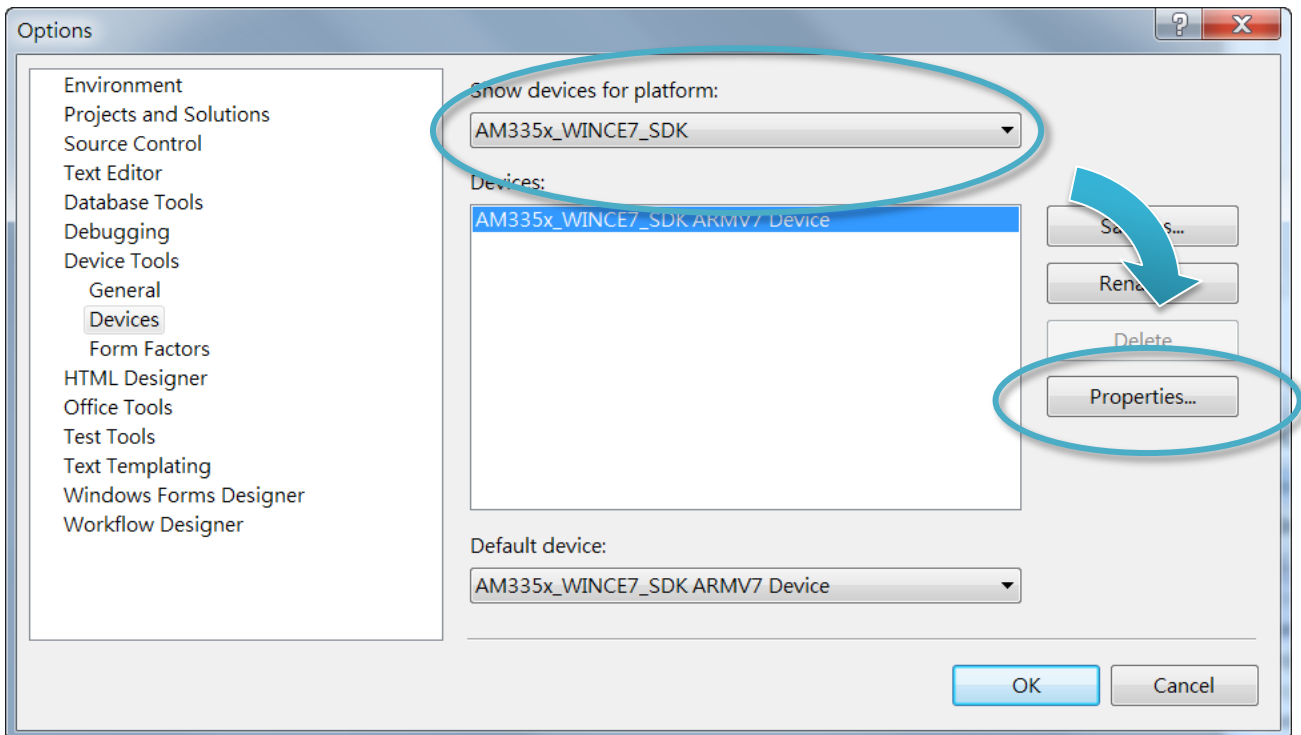

**Step 6: Click the Configure...**

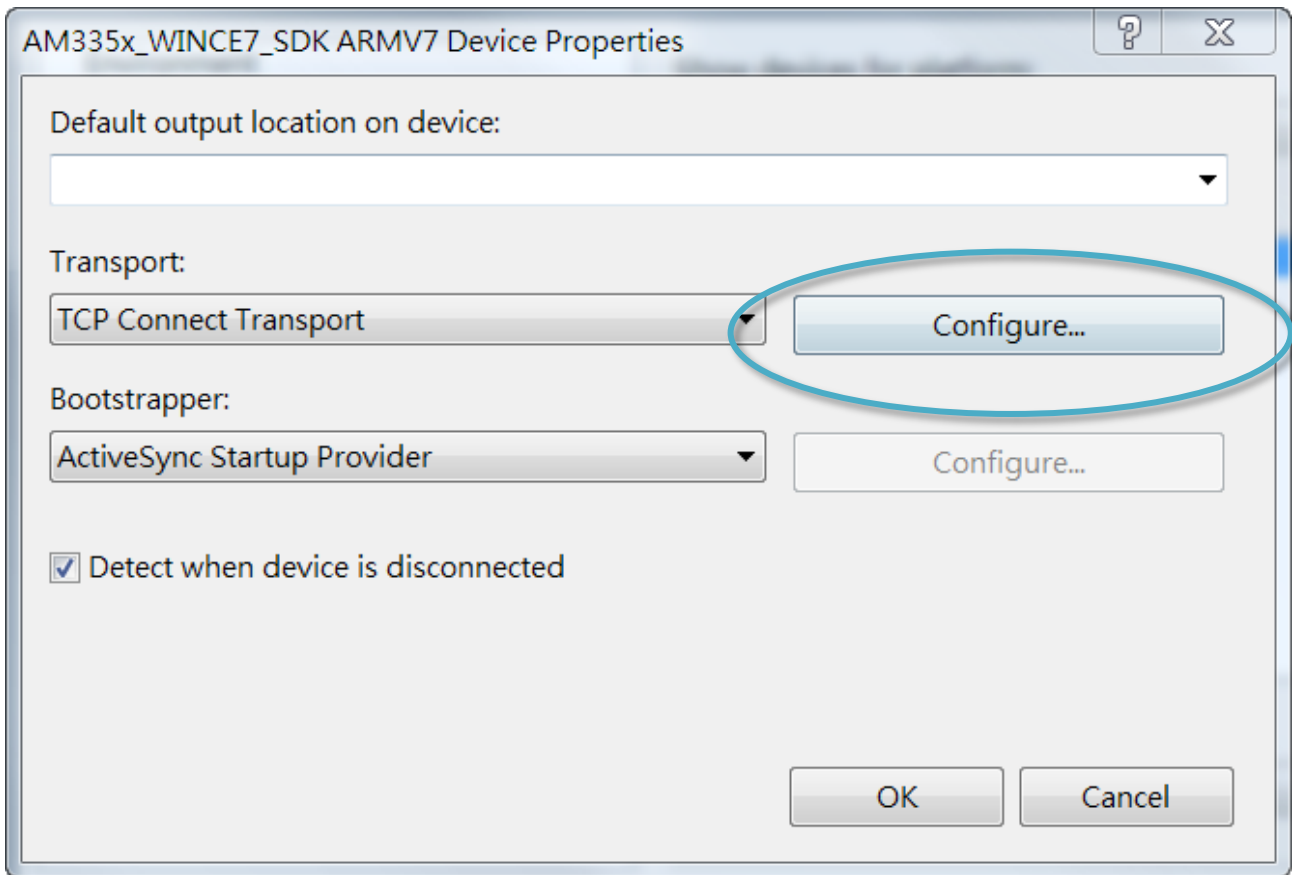

**Step 7: Select the Use specific IP address:, and then type the IP address of VP-x231-CE7**

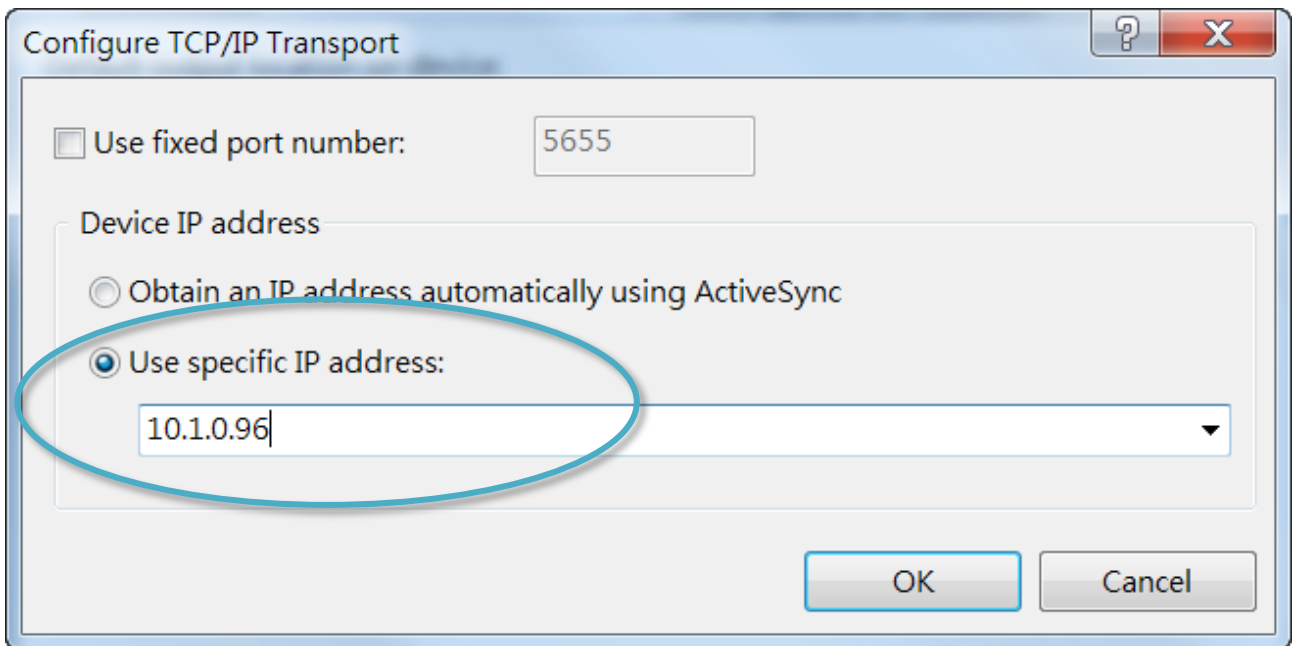

**Step 8: Click the OK, and then click OK to end the dialog**

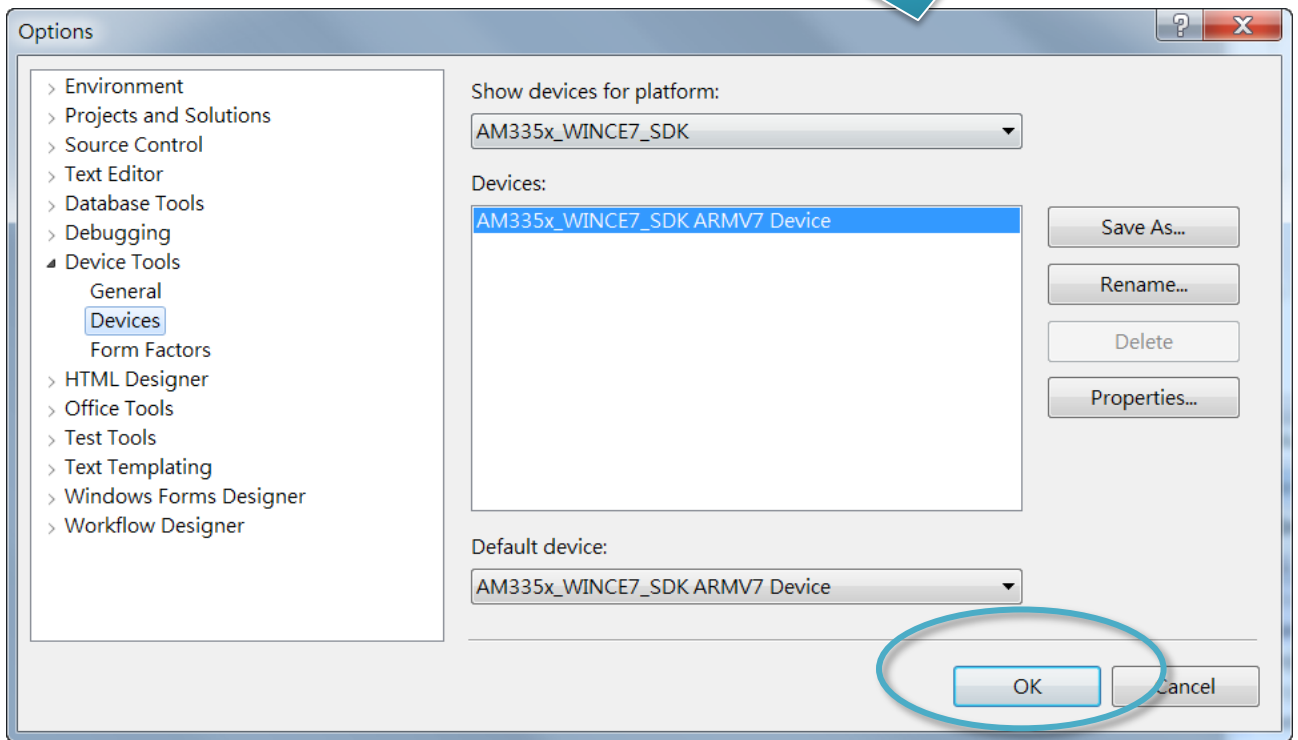
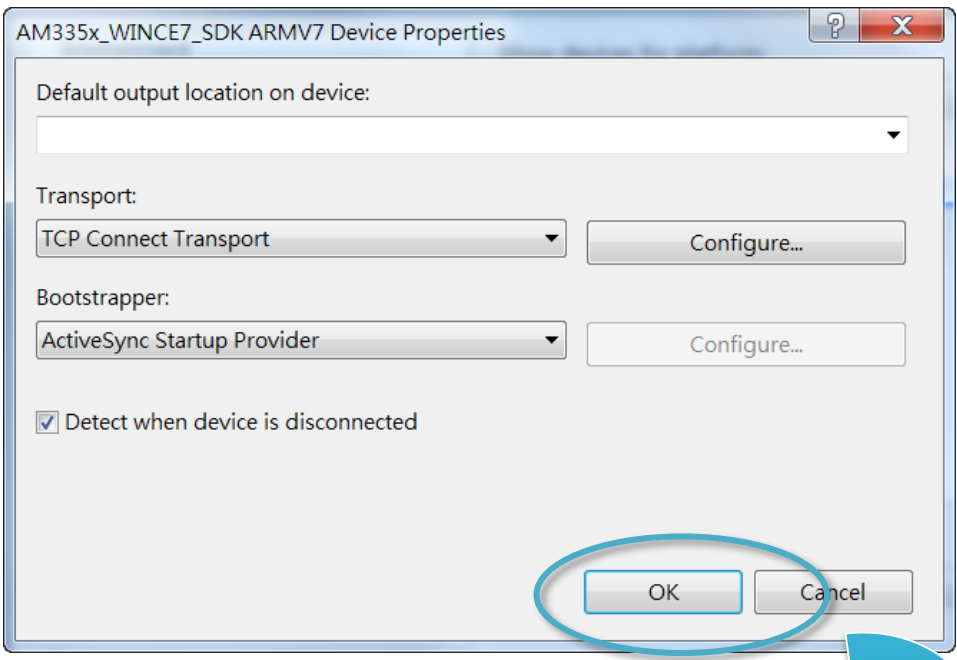

**Step 9: On the Tools menu, click the Connect to Device...**

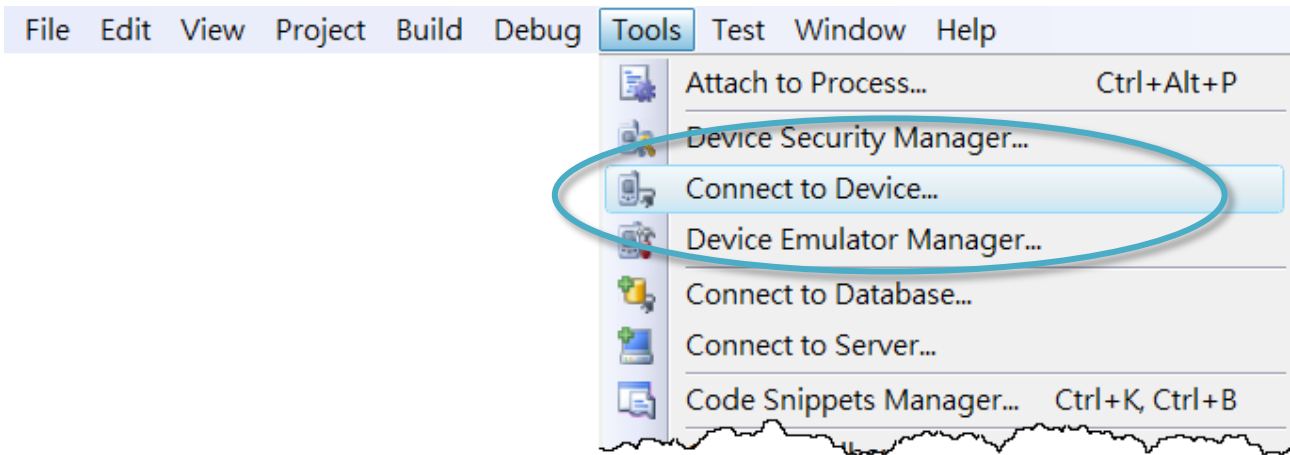

**Step 10: Wait for the connection to be established**

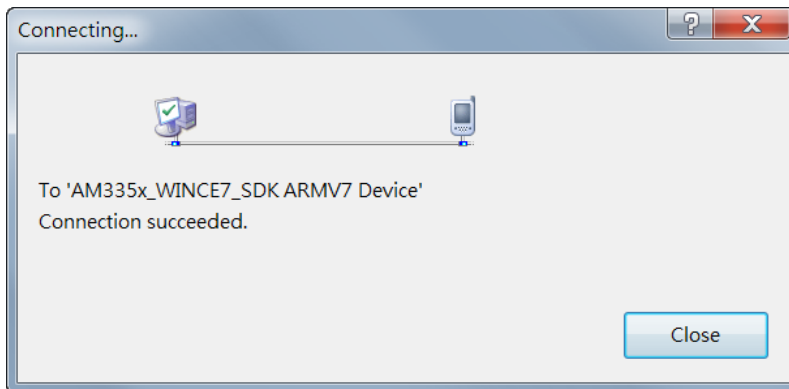

### Tips & Warnings



If the connection fails, as shown below, please repeat the step 2 to step 9 to try it again.

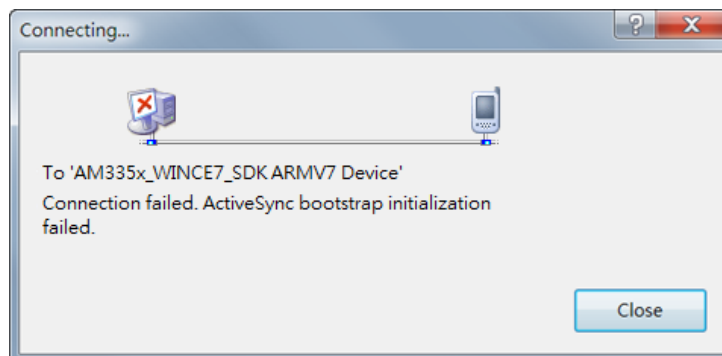

## D. How to Automatically Synchronize VP-x231-CE7 Clock with an Internet Time Server

The clock on the VP-x231-CE7 can be synchronized with an internet time server. This means that the clock is updated to match the clock on the time server, which can help ensure that the time on the VP-x231-CE7 is accurate. Here are step by step instructions on how to synchronize the clock on the VP-x231-CE7 with an Internet time server.

### Step 1: Run the PAC Utility



### Step 2: On the General tab, press Configure button

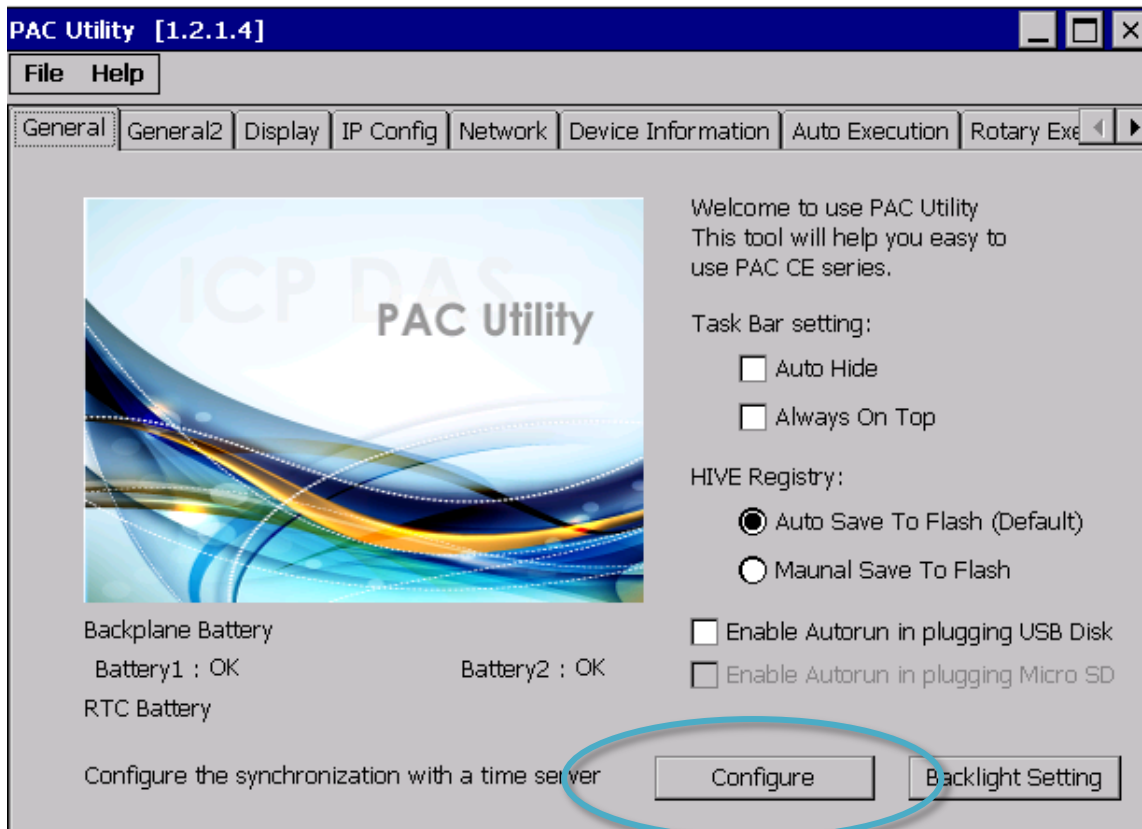

**Step 3: Select the domain name from the Server drop-down list, and then enter a value in the Autoupdate Frequency field**

**Step 4: Check the Automatically synchronize with an internet time server check box**

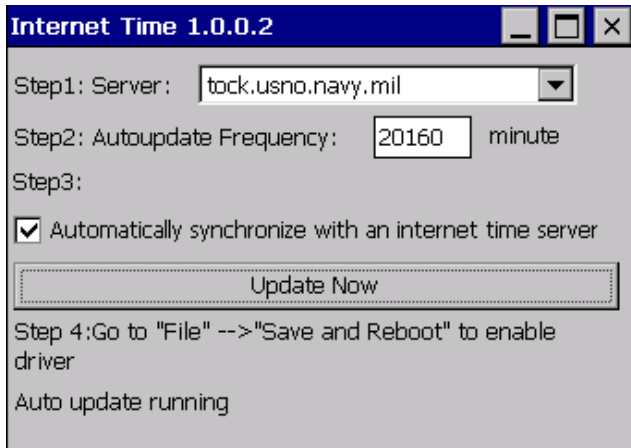

**Step 5: On the File menu, click Save and Reboot**

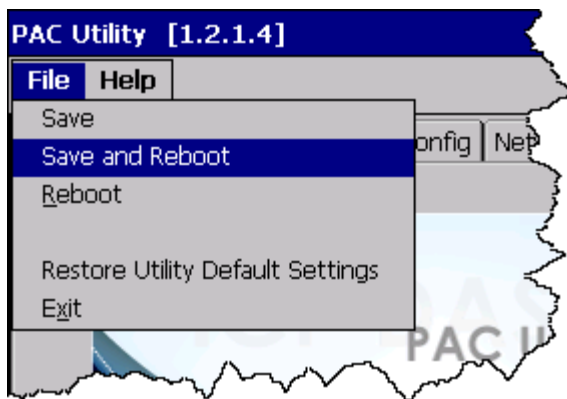

**Step 6: The VP-x231-CE7 will automatically synchronize with an internet time server regularly**

**Step 7: Click the Update Now button to synchronize VP-x231-CE7 clock immediately**

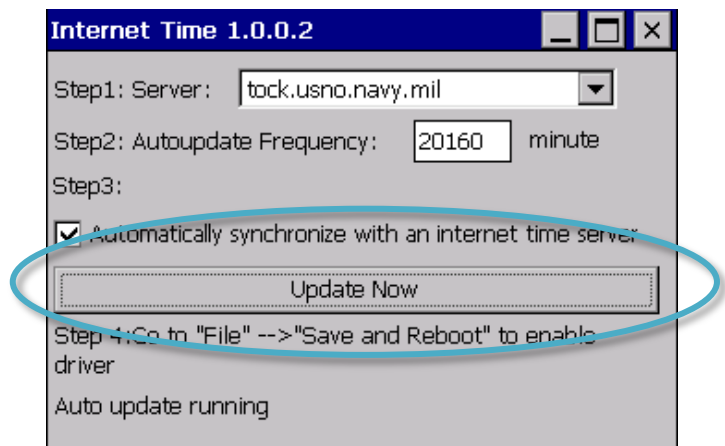

## E. How to Control the User Account Control in VP-x231-CE7

User Account Control is a security feature that helps prevent unauthorized system changes to the VP-x231-CE7.

## E.1. How to Create a User Account

Here are step by step instructions on how to add a user account.

### Step 1: Run the PAC Utility



### Step 2: On the Login tab of the Network tab, click Login tab, type the User Name and Password, and then click Add button

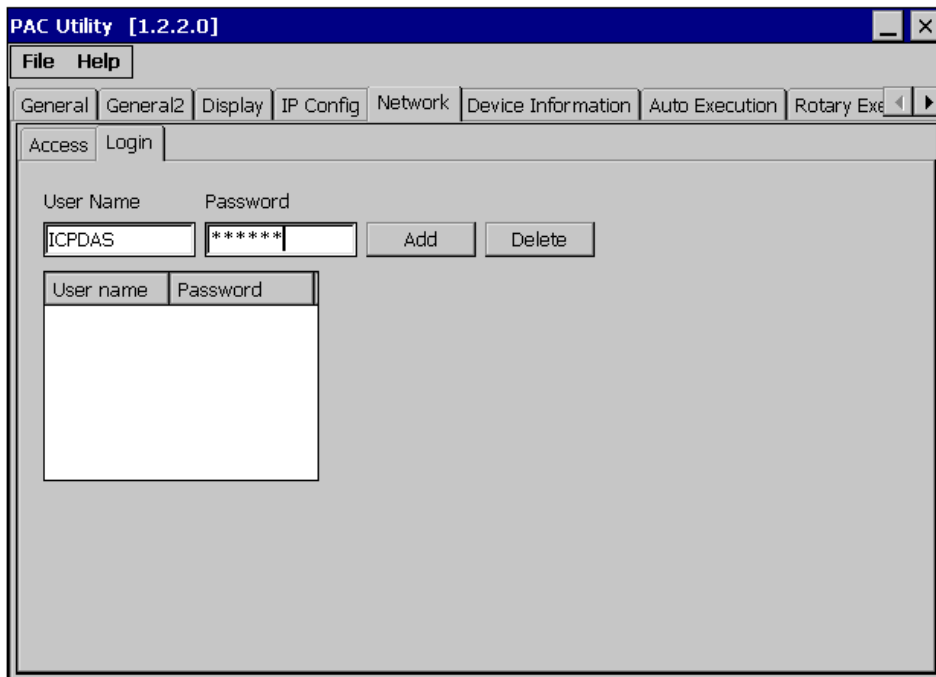



**Step 3: The user has been added to the allowed under the remote login and included in the following list**

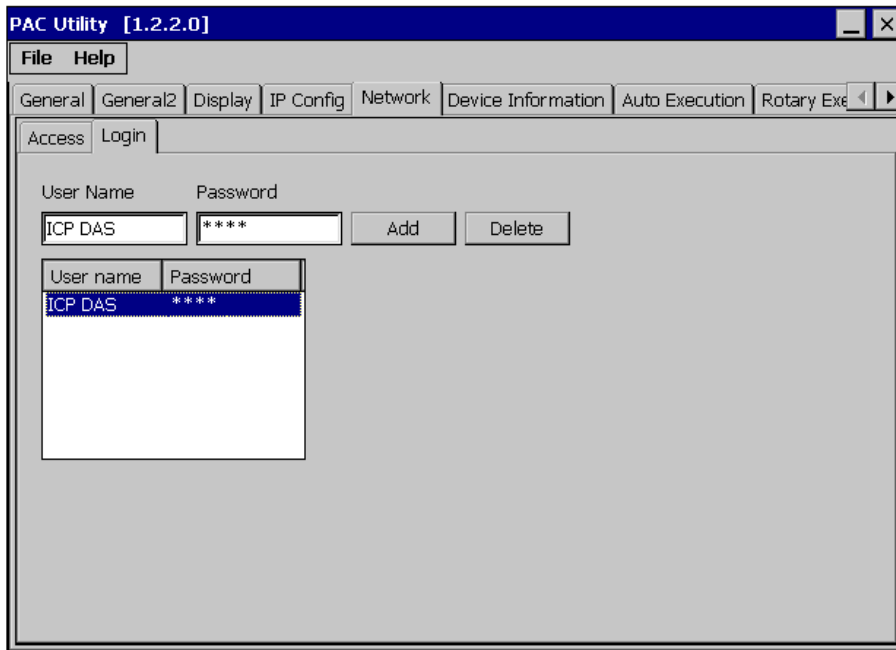

**Step 4: On the File menu, click Save and Reboot for changes to take effect**

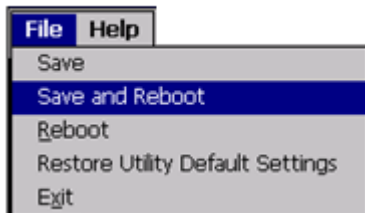

## E.2. How to Use Telnet to Remote Login the ViewPAC from PC

Here are step by step instructions on how to use telnet to remote login the ViewPAC from PC.

### Step 1: On the PC, open a MS-DOS command prompt

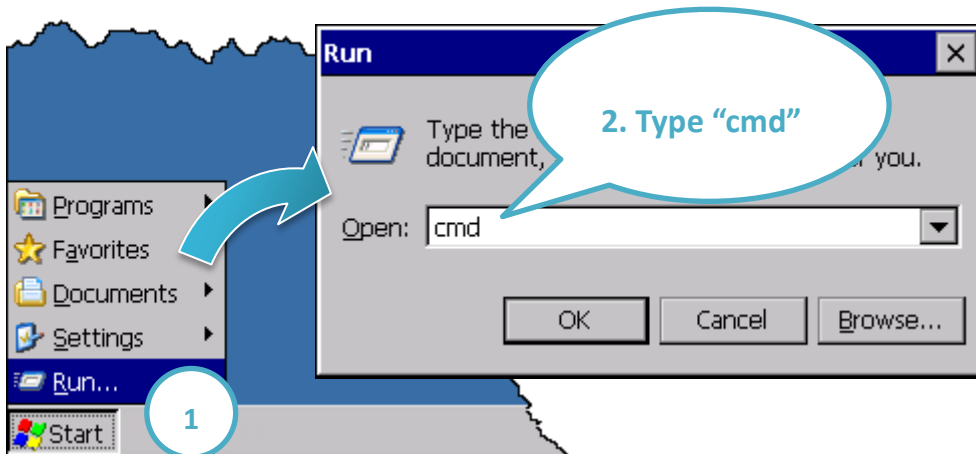

### Step 2: At the command prompt, type "telnet (IP address)"

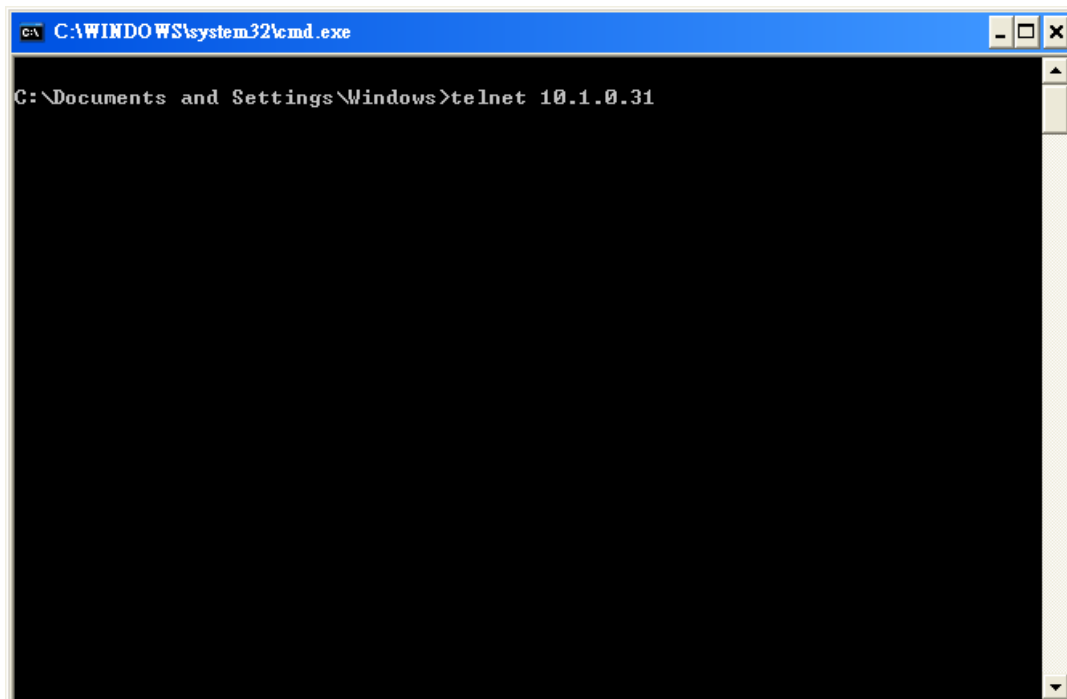

**Step 3: The connection has been set up, and then type the name and password**

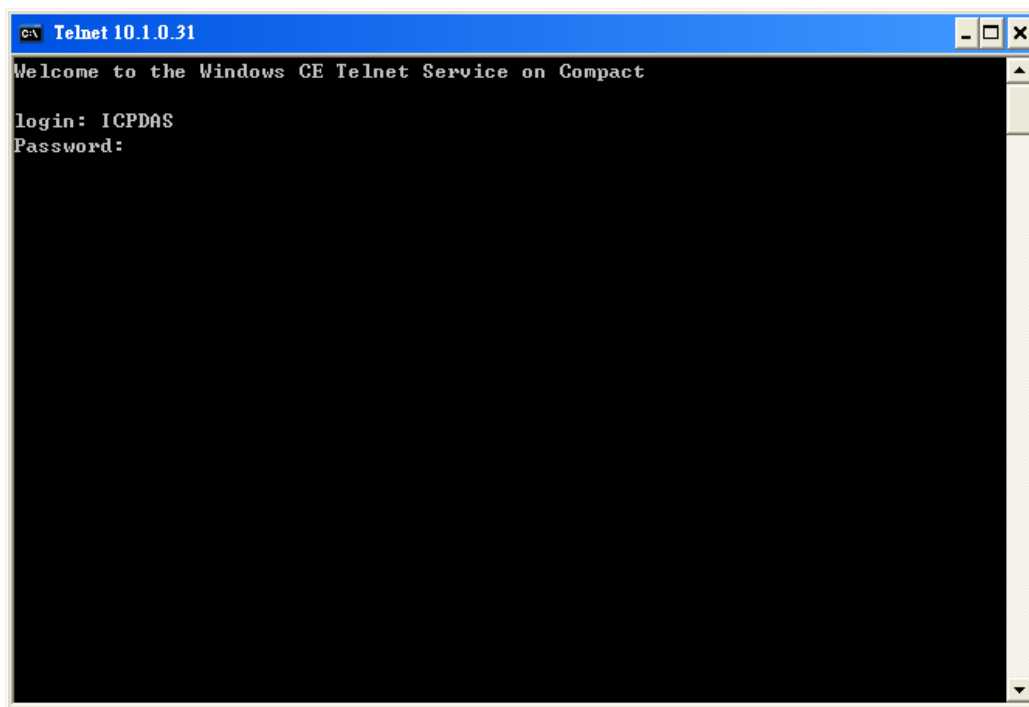

**Step 4: The remote login has been completed**

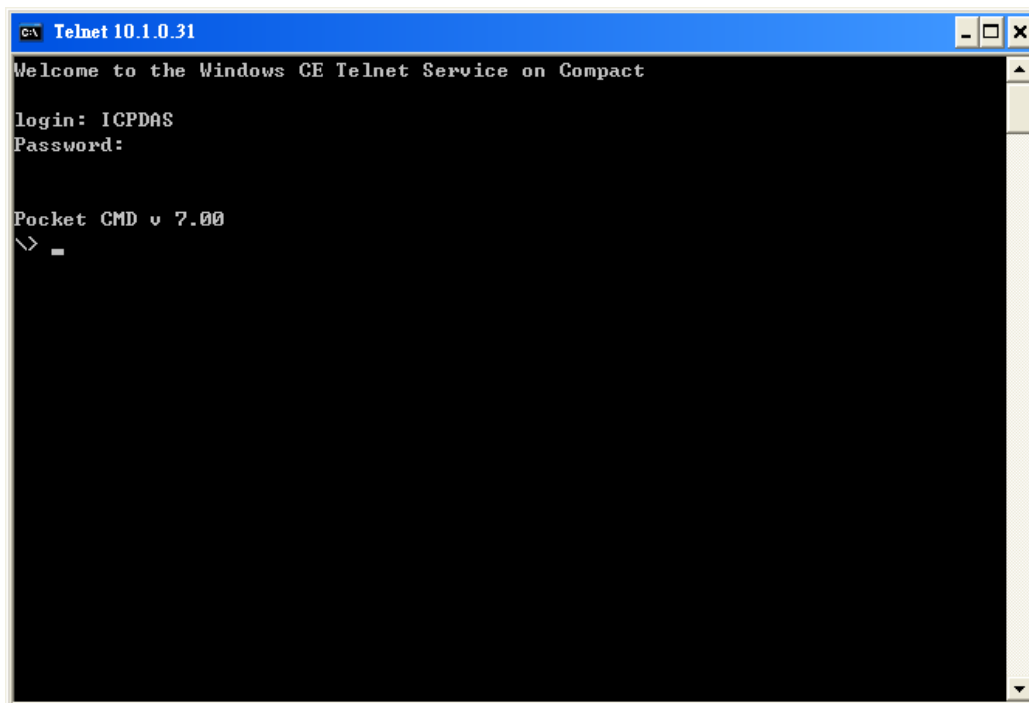

### E.3. How to Remove a User Account from the Login List

Here are step by step instructions on how to remote the user from the login list.

**Step 1: Click a user from the list which you want to remove, and the user will display in the field, and then press Delete to delete the user from the login list**

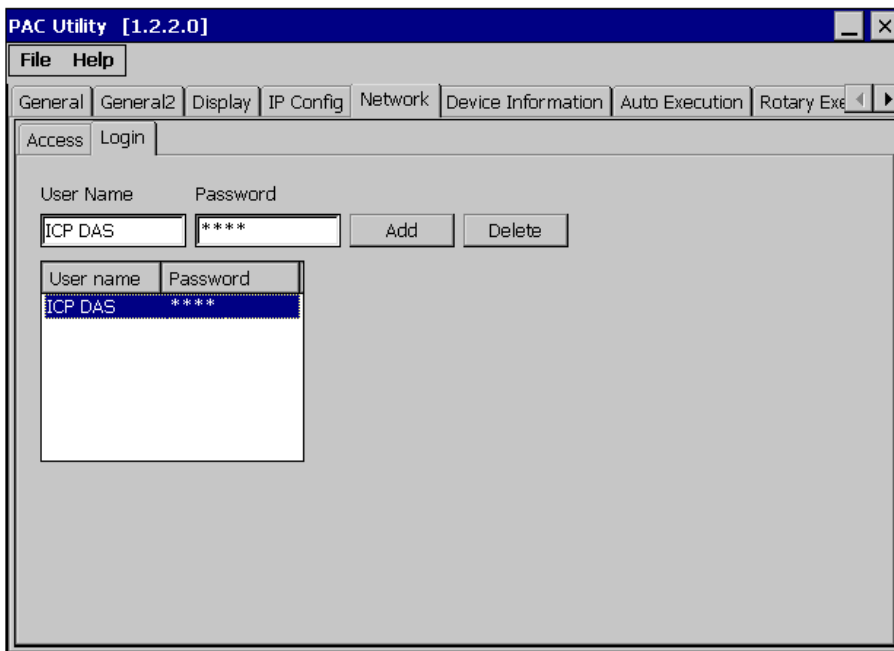

**Step 2: On the File menu, click Save and Reboot for changes to take effect**

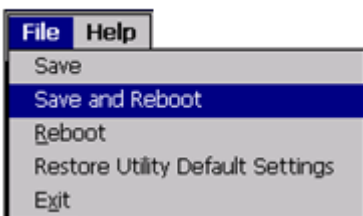

## F. How to Use the Services Tool

The services tool can help you turn on, turn off and monitor the WinCE services.

### Step 1: On the PC, open a MS-DOS command prompt

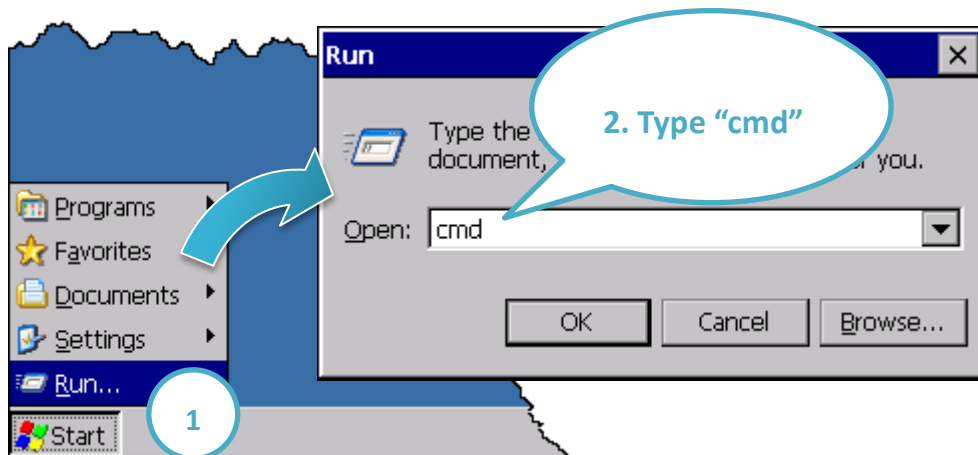

### Step 2: List all services

[Syntax] services list

```
File Edit Help
Pocket CMD v 5.0
\> services list
NFYO: 0x00030110 NOTIFY.D11 Running
HTPO: 0x00031570 HTTPD.DLL Running
CRDO: 0x00032070 credsvc.dll Running
MMQ1: 0x00036790 MSMQD.D11 Off
OBX0: 0x00036b20 OBEXSrVr.dll Off
FTPO: 0x00037770 FTPD.D11 Running
TELO: 0x00037ac0 TELNETD.D11 Running
SMB0: 0x0003c3e0 smbserver.dll Running
NTPO: 0x0003fff0 timesvc.dll Running
\>
```

### Step 3: Type the commands to configure service

[Syntax] services stop <services name>

For example, turn on the “FTP” service:

services stop FTPO:

```
File Edit Help
Pocket CMD v 5.0
\> services stop FTPO:
\> services list
NFYO: 0x00030110 NOTIFY.Dll Running
HTPO: 0x00031570 HTTPD.DLL Running
CRDO: 0x00032070 credsvc.dll Running
MMQ1: 0x00036790 MSMQD.Dll Off
OBX0: 0x00036b20 OBEXSrVr.dll Off
FTPO: 0x00037770 FTPD.Dll Off
TELO: 0x00037ac0 TELNETD.Dll Running
SMB0: 0x0003c3e0 smbserver.dll Running
NTP0: 0x0003fff0 timesvc.dll Running
\>
```

### Tips & Warnings



For more information about using services tool, just type “services help”

```
File Edit Help
Pocket CMD v 5.0
\> services help
Commands:
    help - print this text
    list - lists loaded services
    load <service name> - activates a service that is inactive
    stop <service instance> stops/pauses a service (does not unload)
    start <service instance> - starts/resumes a service
    refresh <service instance> - causes service to refresh its config
    unload <service instance> - causes service to be unloaded and
    register <service name> - service will be automatically loaded
eboot
    unregister <service name> - service will not be automatically
next reboot
    command <service name> [arg1 arg2 ...] - send service-specific
o service
    help <service name> - get information on what service-specific
are supported

    <service name> - service's name in the registry (i.e. HTTPD)
    <service instance> - particular instantiation (i.e. HTPO:)

Flags:
    -f <file name>
    -s silent
    -d output to debugger
\>
```

## G. Revision History

This chapter provides revision history information to this document.

The table below shows the revision history.

Revision	Date	Description
1.0.0	December 2015	Initial issue
1.0.1	May 2016	Added the product information about VP-4231-CE7 and VP-6231-CE7.