



P-8000

User Manual

Version 1.1.4, February 2010

Service and usage information for XP-8000 series

Industry
Computer
Products



Warranty

All products manufactured by ICP DAS are under warranty regarding defective materials for a period of one year, beginning from the date of delivery to the original purchaser.

Warning

ICP DAS assumes no liability for any damage resulting from the use of this product. ICP DAS reserves the right to change this manual at any time without notice. The information furnished by ICP DAS is believed to be accurate and reliable. However, no responsibility is assumed by ICP DAS for its use, not for any infringements of patents or other rights of third parties resulting from its use.

Copyright

Copyright © 2009 by ICP DAS Co., Ltd. All rights are reserved.

Trademark

The names used for identification only may be registered trademarks of their respective companies.

Support

ICP DAS take your problem as ours.

If you have any problem, please feel free to contact us.

You can count on us for quick response.

Email: service@icpdas.com

Tel: 886-3-5973366

Also, the FTP site of ICP DAS has contents about XP-8000 which you may be interested in. We believe that those contents may be helpful to your work.

FTP: <ftp://ftp.icpdas.com/pub/cd/xp-8000>

Contact sales of ICP DAS for OEM or ODM services.

Contact sales: <http://www.icpdas.com/sevices/support.htm>

Table of Contents

Industrial Communication Products

1. General Information	5
1.1. Introduction	6
1.2. Features	7
1.3. Specifications	11
1.4. Dimension (Unit: mm)	14
1.5. Overview	20
1.6. Companion CD	24

2. Quick Start and Recovery	25
------------------------------------	-----------

2.1. Getting started with XP-8000 Hardware	26
2.2. Regional and Language Options	29
2.3. Getting Started with XP-8000 Software	31
2.4. Recovery the XP-8000	35
2.5. Updating the XP-8000	38
2.6. XP-8000 Rescue Disk	41
2.7. Recovery Rescue Disk	42

3. Security Issues	46
---------------------------	-----------

3.1. How to Change the Setting of Auto Logon	47
3.2. How to Configure the Settings of Firewall	49
3.3. How to Change the Status of Enhanced Write Filter (EWF)	51
3.4. How to disable anonymous account of the FTP Server	57
3.5. How to configure the security settings of SQL Server	60



4. Your First Program	62
4.1. Setting up the Development Environment	63
4.2. Creating Your First Program	64
4.2.1. Your First Visual C++ Program	65
4.2.2. Your First Visual Basic Program	73
5. How to use SQL Server Express	79
5.1. SQL Server Management Studio Express	80
5.2. Create a Table for Example	81
Appendix A. Frame Ground	85
Appendix B. XP-8000 Tools	87
B.1. DCON Utility	88
Appendix C. Application of RS-485 Network	89
C.1. Basic RS-485 Network	90
C.2. Daisy Chain RS-485 Network	91
C.3. Star Type RS-485 Network	92
C.4. Random RS-485 Network	93
C.5. Master/Slaves Settings	96
Appendix D. Tips – How To	96
D.1. How to Use Rotary Switch	97
D.2. How to Use DIP Switch	98
D.3. How to Use Multi-IO Modules	99

Table of Contents
 Industrial Communication Products
XP-8000



Industrial Communication Products

1. General Information

This chapter covers the basic information necessary to help you maximize the effectiveness of the XP-8000.

1.1 INTRODUCTION

What is XP-8000?

Basically, XP-8000 is an embedded personal computer which is dedicated to industrial control.

XP-8000 is a new generation PAC of ICP DAS. It equips a AMD LX 800 CPU (500MHz) running a Windows Embedded Standard 2009 operating system, variant connectivity (VGA, USB, Ethernet, RS-232/RS-485) and 0/3/7 slots for high performance parallel I/O modules (high profile I-8K series) and serial-type I/O modules (high profile I-87K I/O modules).

Its operating system, Windows Embedded Standard 2009, has many advantages. Most of all, Windows Embedded Standard 2009 has the same Win32 API as Windows XP Professional, that is, almost every desktop program can be easily ported to Windows Embedded Standard 2009. This effectively reduces the efforts of developments and shortens the time to market.

1.2 FEATURES

Software Features

Windows Embedded Standard 2009

Most of the popular features in Microsoft software are included, such as:

IIS:

IIS stands for Internet Information Services. Microsoft provides Internet Information Services to make hosting web services easily and reliably. In XP-8000, FTP Server and Web Server are provided. The Web Server supports both VBScript and JavaScript.

ASP.NET:

ASP stands for Active Server Pages. ASP is an active scripting engine that runs on the server side and dynamically creates web pages for client's requests. ASP.NET is based on Microsoft's .NET technology.

SQL Server 2005 Express Edition

SQL, Structured Query Language, is a computer language for database. SQL Server is a server of database that implements SQL query language. Microsoft SQL Server 2005 Express Edition is a database platform that is based on Microsoft SQL Server 2005. Using SQL Server 2005 Express Edition, it is easy to develop data-driven applications that are rich in capability, offer enhanced storage security, and are fast to deploy.
(reference: [MSDN](#))

.NET Framework 3.5:

Microsoft's .NET Framework provides a run-time environment, CLR, and plenty of class libraries to simplify development processes. CLR is Common Language Runtime. It provides cross-language integration, enhanced security, etc. Windows Embedded Standard 2009 supports up to .NET Framework 3.5. Therefore, we provide .NET Framework 3.5 in XP-8000.

Many others:

There still are others such as Internet Explorer, Outlook Express, Windows Media Player, Remote Desktop Connection, etc.

Built-in OPC Server

SCADA software can easily integrate I/O modules through it. OPC stands for OLE (Object Linking and Embedding) for Process Control which is developed by Microsoft for industrial automation.

Furthermore, Quicker also provides a library which users can use to develop their applications by Visual C++, Visual C#.NET or Visual Basic.NET.

Quicker not only supports I/O modules in local slots, but also supports Remote I/O modules with the following protocols via the RS-232/RS-485 or Ethernet:

1. Modbus/RTU
2. Modbus/ASCII
3. Modbus/TCP
4. DCON

DCON Utility

DCON Utility is an application that provides an environment to easily and quickly search, configure and test I/O modules in the networks. See Appendix B.1. for details.

Rich Software Solutions

XP-8000 equips with Windows Embedded Standard 2009 which is compatible with the popular operating system, Windows XP. Thus there are rich software solutions users can find. The followings are commonly-used development tools:

Microsoft Visual Studio.NET 2003/2005/2008 and Visual Studio 6.0 solution:

ICP DAS provides SDK as well as demo programs for Visual C#.NET, Visual Basic.NET and Visual C++.

Borland Delphi and C++ Builder: SDK and demo programs are provided as well.

SCADA solution: InduSoft provides simple “drag and drop”, “point and click” developing environment for HMI and SCADA applications.

Power CPU module

The most important features of the CPU module are

AMD LX800 CPU (32-bit and 500MHz)

1 GB RAM

4GB Built-in Flash Disk

Built-in VGA Port

A built-in VGA port can be directly connected to a regular LCD display. Users can operate the HMI or SCADA software (running on the XP-8000) with display, keyboard and mouse just as how they usually did on regular PCs.

64-bit Hardware Serial Number

The 64-bit hardware serial number is unique and individual. Every serial number of XP-8000 is different. Users can add a checking mechanism to their AP to prevent software from pirating.

Built-in Flash Disk (4GB)

In normal situation, users can store their AP or data to the CF card or USB Flash disk. But in some vibration environment (for example, like driving ships), the two storage media would be bad connection. Then the built-in Flash disk will be the best storage media in such the vibration environment.



☑ Dual Watchdog Timer

A system could be hanged up when the OS or the AP fails. There are two watchdogs (OS watchdog and AP watchdog) designed to automatically reset the CPU when the situations happen. The design will increase the reliability of the system.

☑ Dual Battery-Backup SRAM (512KB)

To maintain important data while power off, non-volatile memory is the ideal design. The XP-8000 equips a 512KB SRAM with two Li-batteries to maintain data while power off.

The two Li-batteries can continually supply power to the 512KB SRAM to retain the data for 5 years; and the dual-battery design can avoid data lost while replacing a new battery.

☑ Dual Ethernet Ports

XP-8000 provides two Ethernet ports. The two Ethernet ports can be used to implement redundant Ethernet communication and separate Ethernet communication (one for global Internet, one for private Ethernet).

☑ Redundant Power Input



To prevent the XP-8000 from failing by the power loss, the power module is designed with two input connectors. Once a power input fails, the power module switches to the other power input. And there is a relay output for informing the power failure.

☑ Ventilated housing designed to operate between -25°C ~ +75°C

Each XP-8000 is housed in a plastic-based box with a column-like ventilator that can help to cool the working environment inside the box and allow the XP-8000 operating between -25°C and +75°C.

1.3 SPECIFICATIONS

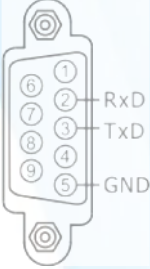
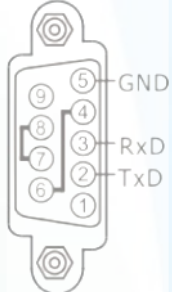
Feature	Items	Description
Processor Module	CPU	AMD LX 800 processor
	System Chipset	AMD CS5536
	System Memory	1 GB RAM
	BIOS	Award 4M bits flash ROM BIOS
Operating System		Microsoft Windows Embedded Standard 2009 (including SQL Server 2005 Express; Internet Information Service 5.1)
Storage	Flash	4GB as IDE Master (Flash)
	Dual Battery Backup SRAM	512KB (for 5 years data retain)
	EEPROM	16KB, data retention: 40 years 1,000,000 erase/write cycles.
	CF Card	8GB (support up to 32 GB) (Hot plug unsupported)
Graphic	Graphic Chip	AMD LX800 integrated graphic controller
	VGA resolution	(640 x 480 ~ 1600 x 1200)
Ethernet	Controller	RJ-45*2, 10/100Mbps Base-TX Ethernet Controller (Auto-negotiating, Auto_MDIX, LED indicator)
Expansion Slots		One Proprietary-definition expansion for ISA and DC-in One PCI-expansion with Hirose FX8C-120P-SV6(22)
Dual Watchdog Timer		Yes
64-bit Hardware Serial Number		Yes
Rotary Switch		Yes (0 ~ 9)
DIP Switch		Yes (8 bits) (for XP-8341 and XP-8741 only)
USB2.0		x 2

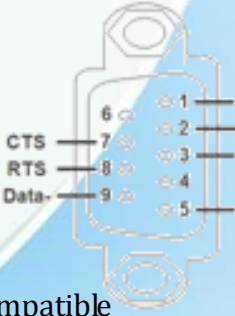
Feature	Items	Description
	COM1	RS-232 (Internal communications with I-87K modules in slots, for XP-8341/8741 only; external COM1 only for XP-8041) Baud Rate: 115200 bps Data Bits: 8 Parity: None, Even, Odd Stop Bits: 1 Note: CPU built-in UART 
	COM2	RS-232, Non-isolation (TXD, RXD and GND) (used to update firmware) Baud Rate: 115200, 57600, 38400, 19200, 9600, 4800, 2400, 1200 bps Data Bits: 7, 8 Parity: None, Even, Odd Stop Bits: 1 Note: CPU built-in UART 
Serial Port	COM3	RS-485 Baud Rate: 115200, 57600, 38400, 19200, 9600, 4800, 2400, 1200 bps Data Bits: 5, 6, 7, 8 Parity: None, Even, Odd, Mark (Always 1), Space (Always 0) Stop Bits: 1, 2 FIFO: 16 bytes Note: 16C550 compatible
	COM4	RS-232/485 Baud Rate: 115200, 57600, 38400, 19200, 9600, 4800, 2400, 1200 bps Data Bits: 5, 6, 7, 8 Parity: None, Even, Odd, Mark (Always 1), Space (Always 0) Stop Bits: 1, 2 FIFO: 16 bytes  Note: 16C550 compatible COM4 can be configured as either RS-232 or RS-485, and the configuration depends on the pin 

Feature	Items	Description
		connections as follows: RS-232 (RXD, TXD, CTS, RTS and GND) RS-485 (Data+ and Data-) There is no software configuration or hardware jumper needed.
	COM5	RS-232 Baud Rate: 115200, 57600, 38400, 19200, 9600, 4800, 2400, 1200 bps Data Bits: 5, 6, 7, 8 Parity: None, Even, Odd, Mark (Always 1), Space (Always 0) Stop Bits: 1, 2 FIFO: 16 bytes Note: 16C550 compatible
Environment	Operating Temp	-25°C ~ +75°C
	Storage Temp	-30°C ~ +85°C
	Relative Humidity	5% ~ 90% RH, non-condensing
Mechanical	XP-8041	116 mm (W) x 132 mm (L) x 125 mm (H)
	XP-8341	231 mm (W) x 132 mm (L) x 125 mm (H)
	XP-8741	355 mm (W) x 132 mm (L) x 125 mm (H)
Power	XP-8041	Capacity: 1.8A, 5V supply to CPU and backplane, total 15W Consumption: 14.4 W (0.6 A @ 24 VDC)
	XP-8341	Capacity: 1.8A, 5V supply to CPU and backplane; 5.2A, 5V supply to I/O expansion slots, total 35W Consumption: 14.4 W (0.6 A @ 24 VDC)
	XP-8741	Capacity: 2.0A, 5V supply to CPU and backplane; 5.0A, 5V supply to I/O expansion slots, total 35W Consumption: 16.8 W (0.7 A @ 24 VDC)

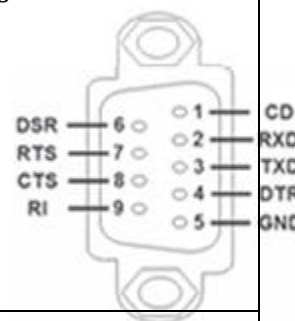

1.4 DIMENSION (UNIT: MM)

XP-8041

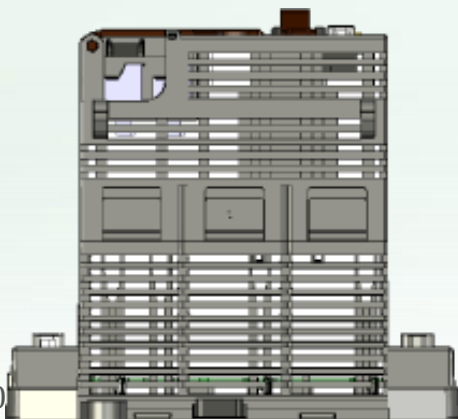
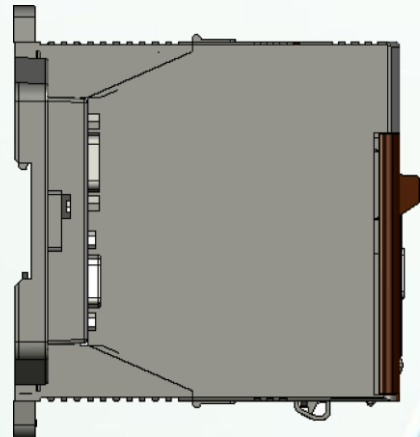
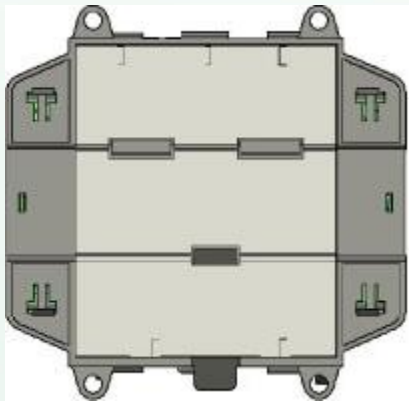
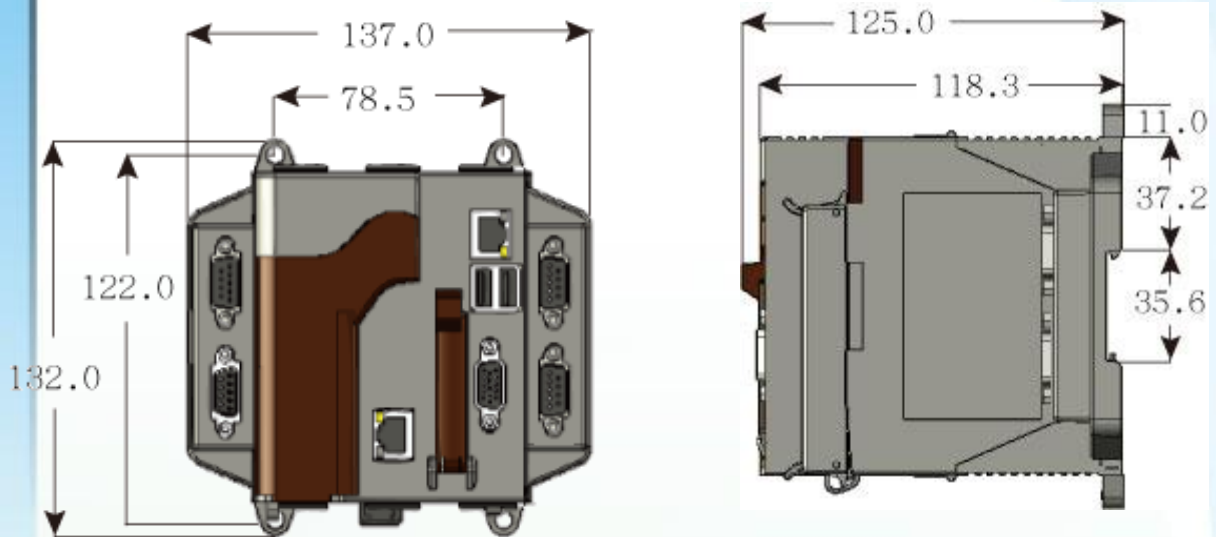

XP-8341

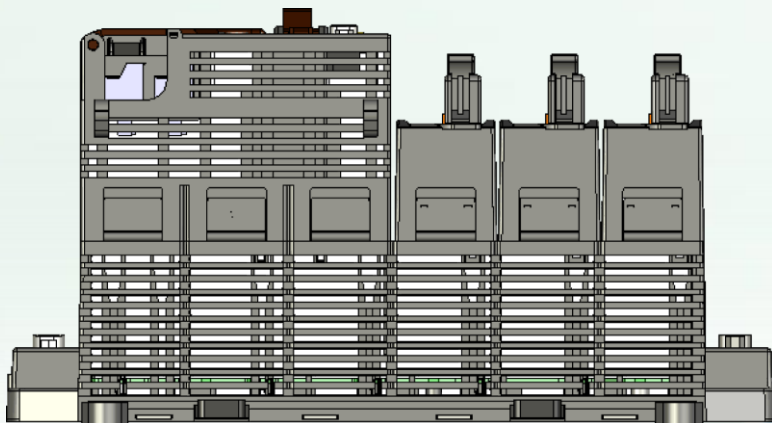
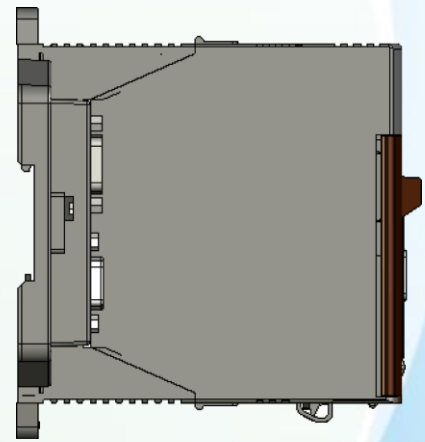
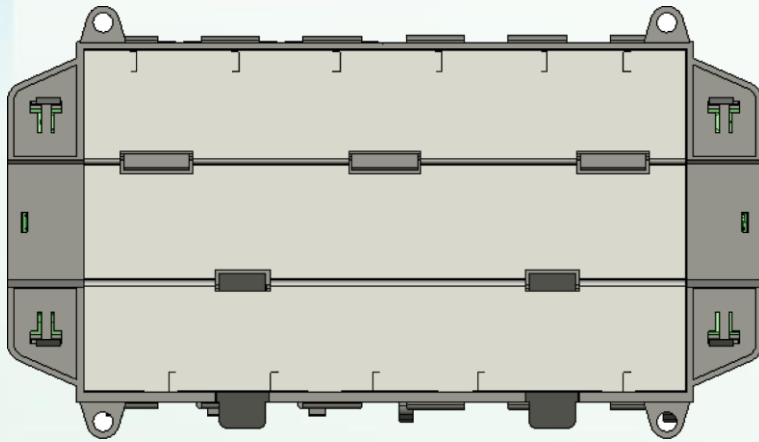
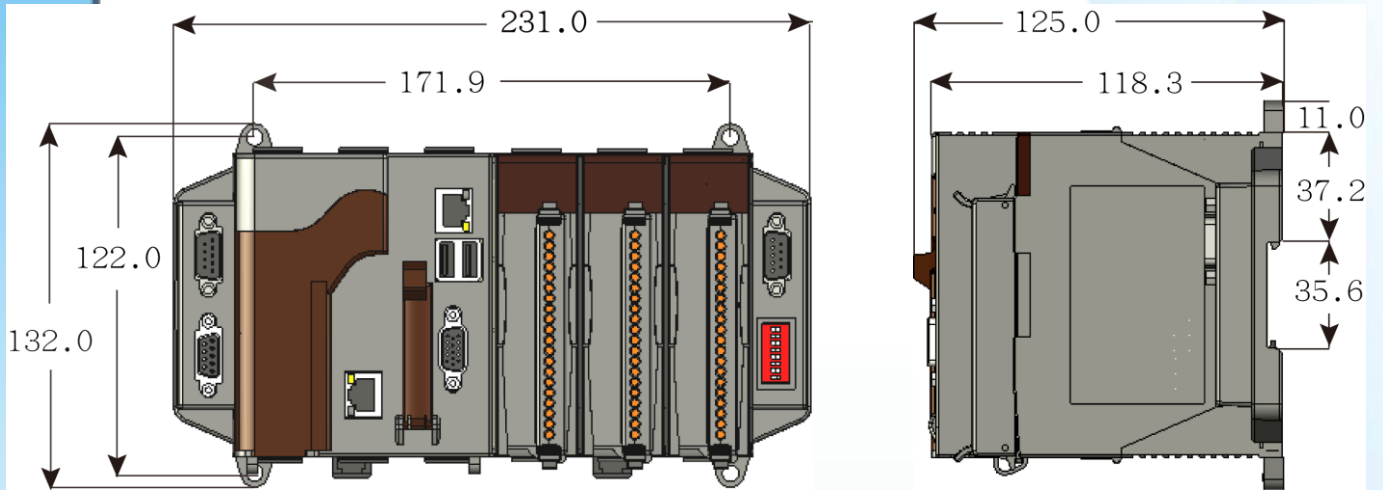

XP-8741

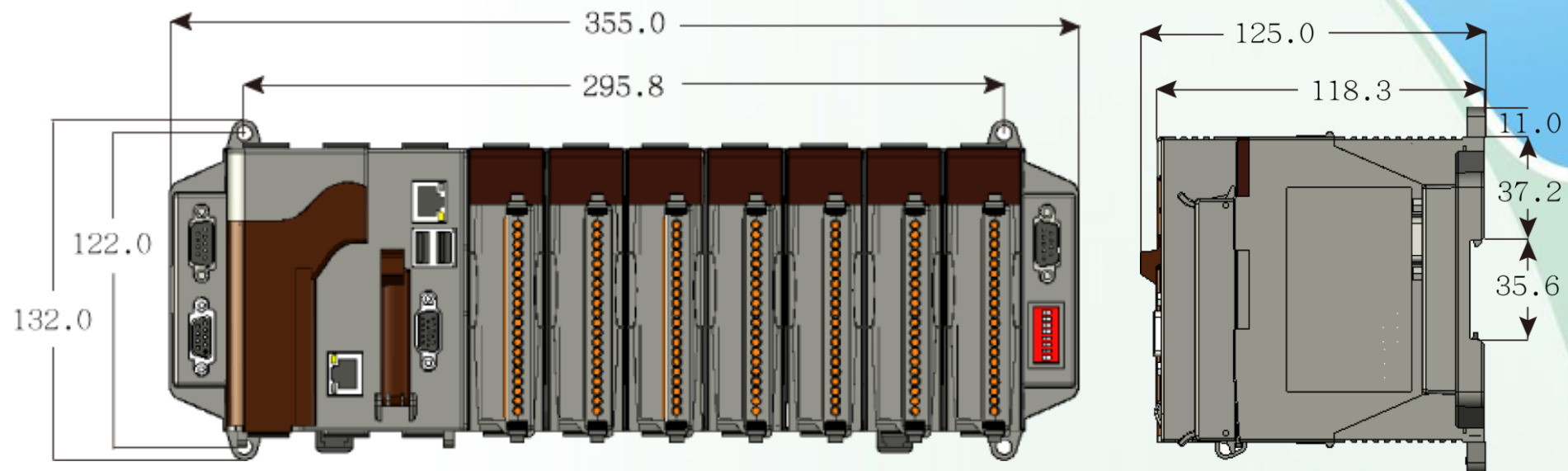

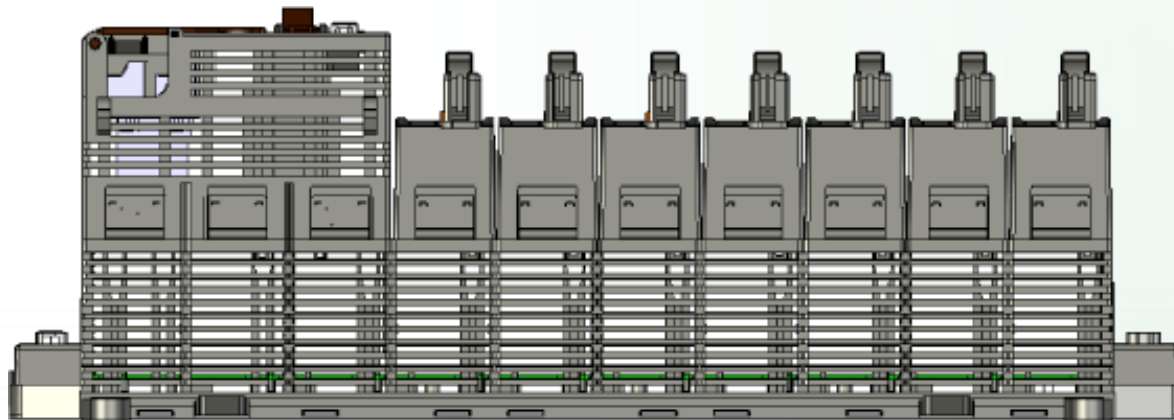
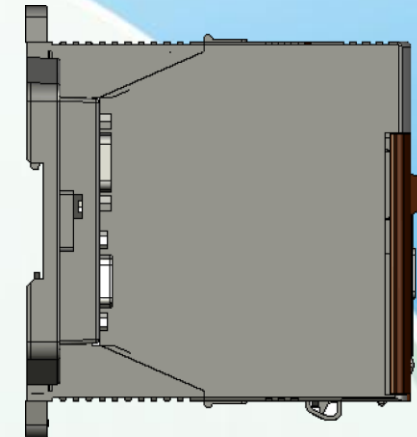
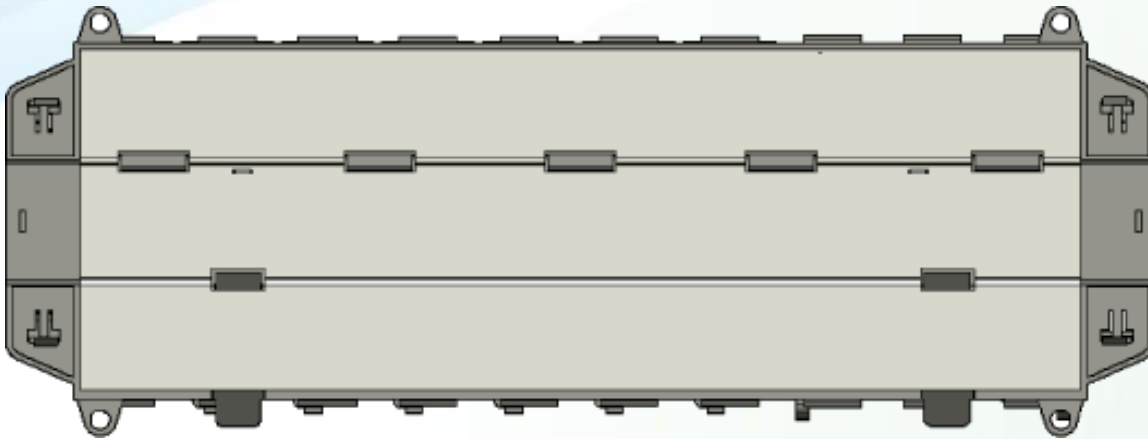

1.5 OVERVIEW

XP-8041

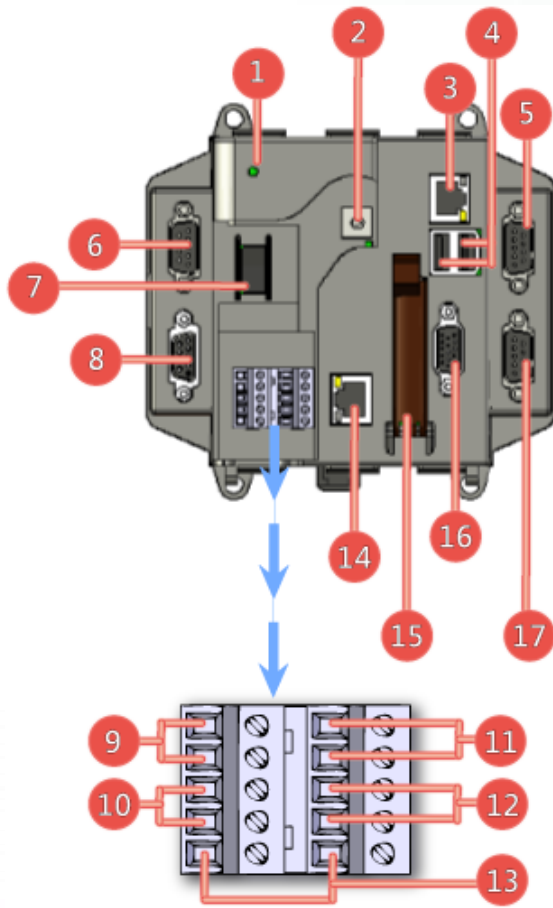

Overview Item Descriptions

1. Power LED Indicator
2. Rotary Switch
3. Ethernet Port 1
4. USB 2.0 Ports
5. COM Port 5 (RS-232)
6. COM Port 4 (RS-232/RS-485)
7. Power Switch
8. COM Port 2 (RS-232)
9. Power and Ground
10. COM Port 3 (RS-485)
11. Redundant Power and Ground
12. Relay Output R.COM and R.NO
13. Frame Ground
14. Ethernet Port 2
15. CF (Compact Flash) Card Slot
16. VGA Port
17. COM Port 1 (RS-232)

XP-8341

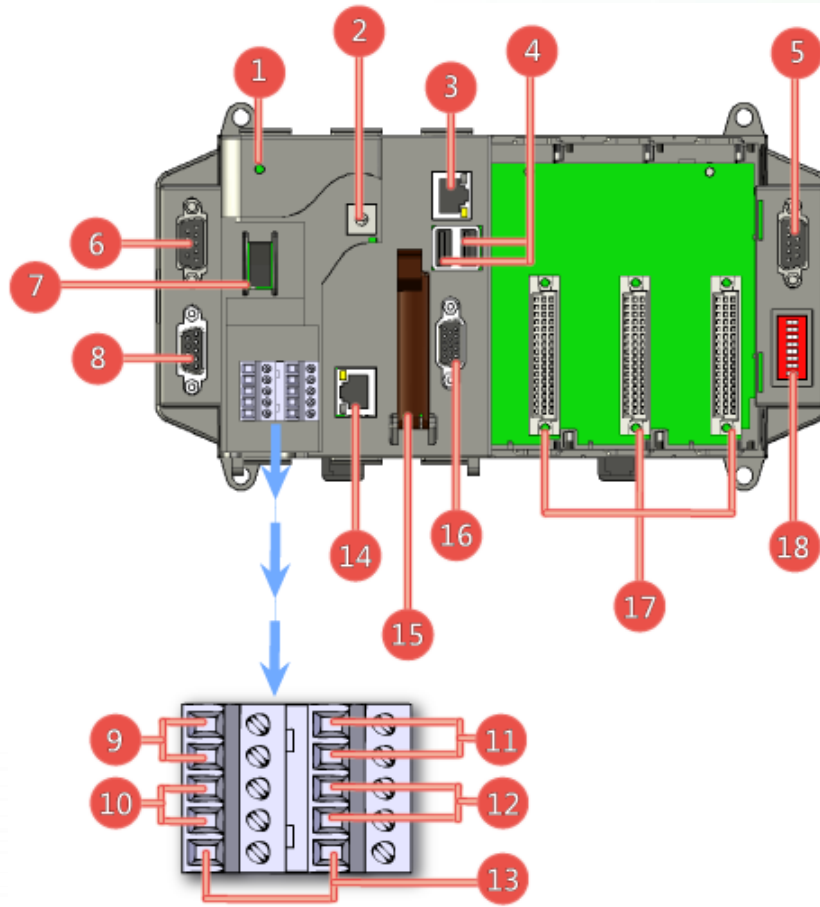

Overview Item Descriptions

1. Power LED Indicator
2. Rotary Switch
3. Ethernet Port 1
4. USB 2.0 Ports
5. COM Port 5 (RS-232)
6. COM Port 4 (RS-232/RS-485)
7. Power Switch
8. COM Port 2 (RS-232)
9. Power and Ground
10. COM Port 3 (RS-485)
11. Redundant Power and Ground
12. Relay Output R.COM and R.NO
13. Frame Ground
14. Ethernet Port 2
15. CF (Compact Flash) Card Slot
16. VGA Port
17. Slot 1 ~ Slot 3
18. DIP Switch

XP-8741

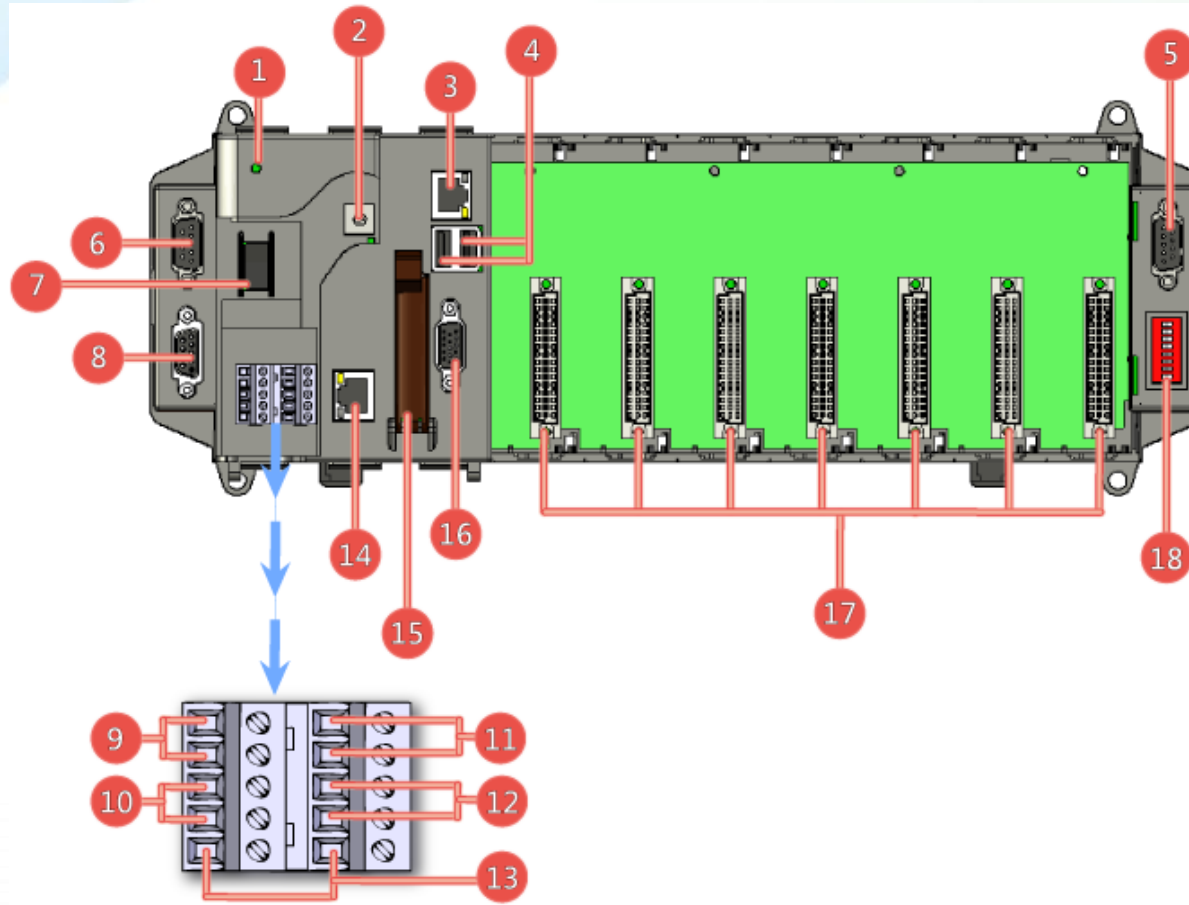

Overview Item Descriptions

1. Power LED Indicator
2. Rotary Switch
3. Ethernet Port 1
4. USB 2.0 Ports
5. COM Port 5 (RS-232)
6. COM Port 4 (RS-232/RS-485)
7. Power Switch
8. COM Port 2 (RS-232)
9. Power and Ground
10. COM Port 3 (RS-485)
11. Redundant Power and Ground
12. Relay Output R.COM and R.NO
13. Frame Ground
14. Ethernet Port 2
15. CF (Compact Flash) Card Slot
16. VGA Port
17. Slot 1 ~ Slot 7
18. DIP Switch



Description of XP-8000 Storage

- Built-in Flash Disk

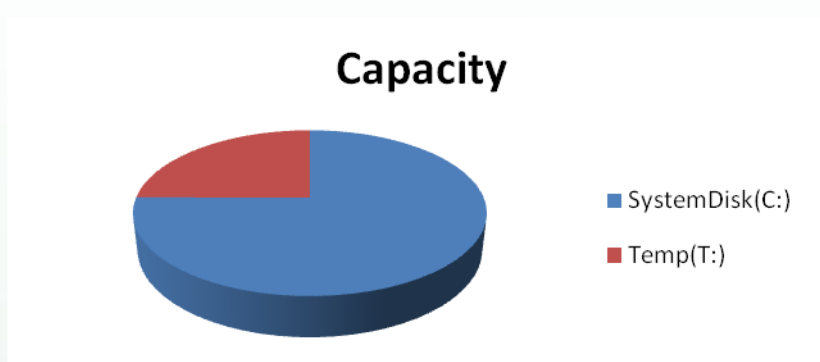

[C] System Disk:

This partition, protected by EWF, contains OS, services, and applications. All manipulations of this device are operated on this partition.

[T] Temp Disk:

This partition, unprotected by EWF, stores the event logs and temporary files.

- Compact Flash (CF HOT PLUG Unsupported)

[D] Data Disk: the default letter of compact flash is [D] and unprotected by EWF.

1.6 COMPANION CD

The companion CD contains full usage documents, software tools and development resources related to the XP-8000.

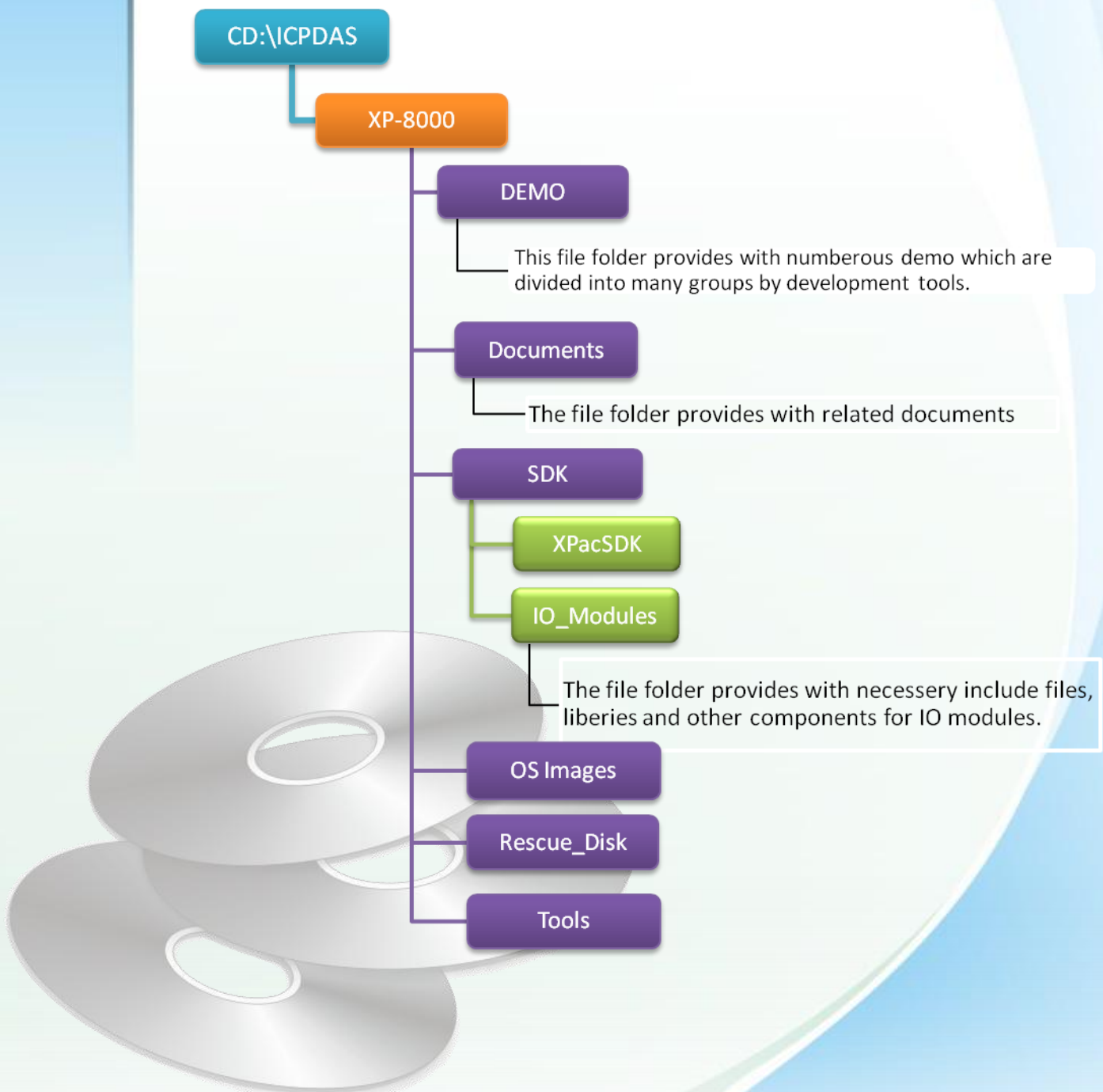



Industrial Communication Products

2. Quick Start and Recovery

This chapter covers basic steps required to help you install the XP-8000 and give you a brief of outline of its main functions.

2.1. GETTING STARTED WITH XP-8000 HARDWARE

Follow these steps below to install and start-up the XP-8000.

The XP-8000 installation must provide proper ventilation, spacing, and grounding to ensure the equipment will operate as specified. A minimum clearance of 50mm between the XP-8000 and the top and bottom side of the enclosure panels must be provided.

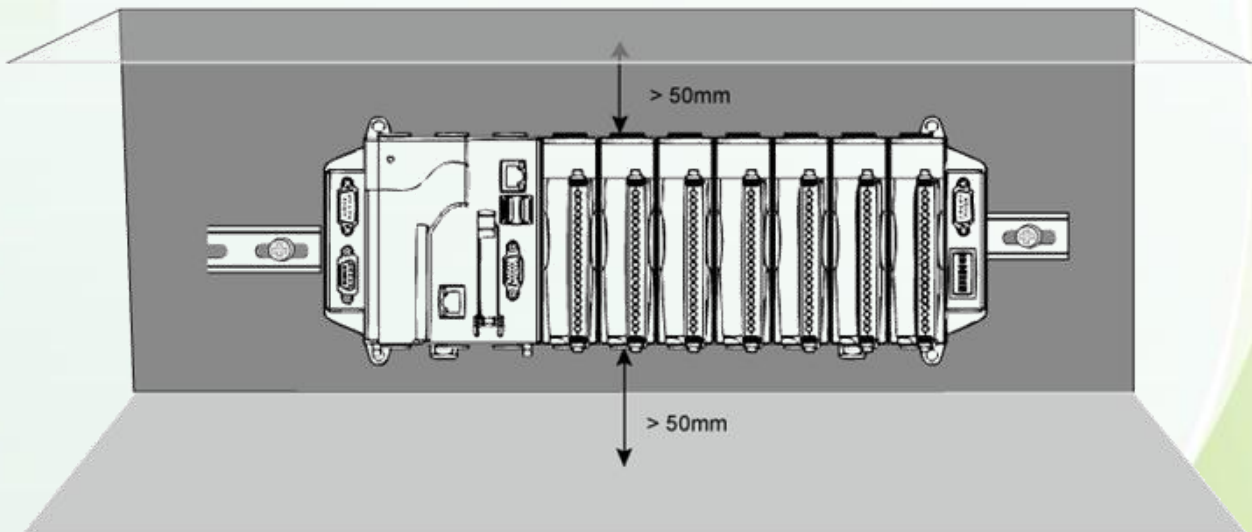

There is a minimum of 50mm clearance between the top and bottom edges of the XP-8000 and the enclosure panels.

Step 1: Mount the hardware

There are two simple methods of mounting:

1. DIN-Rail mounting

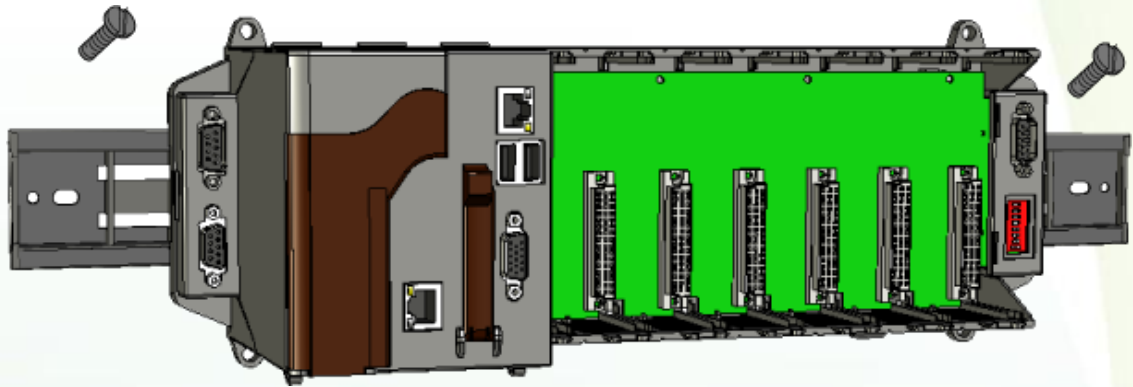

2. Screw mounting

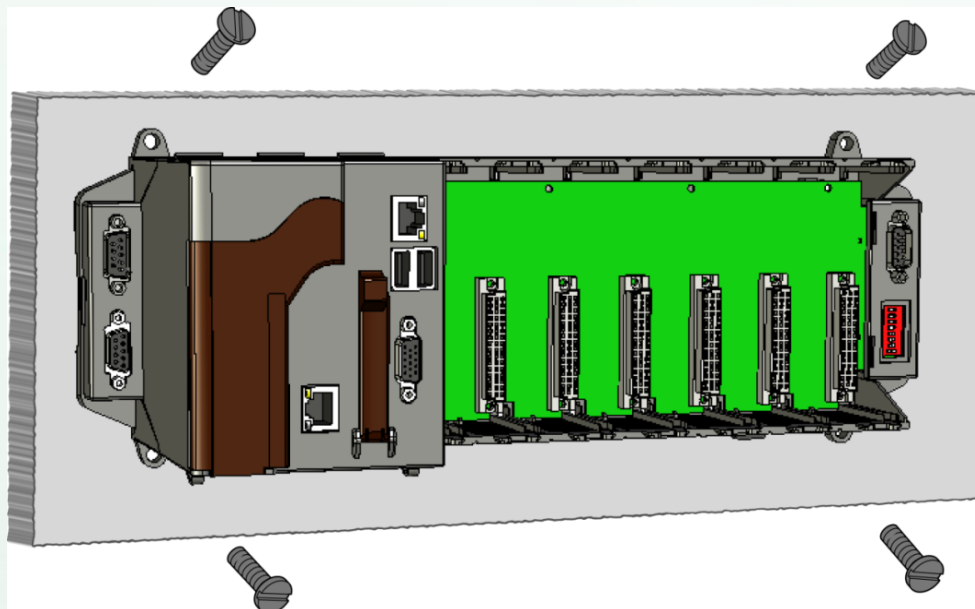

Step 2: Connect the power, network and monitor

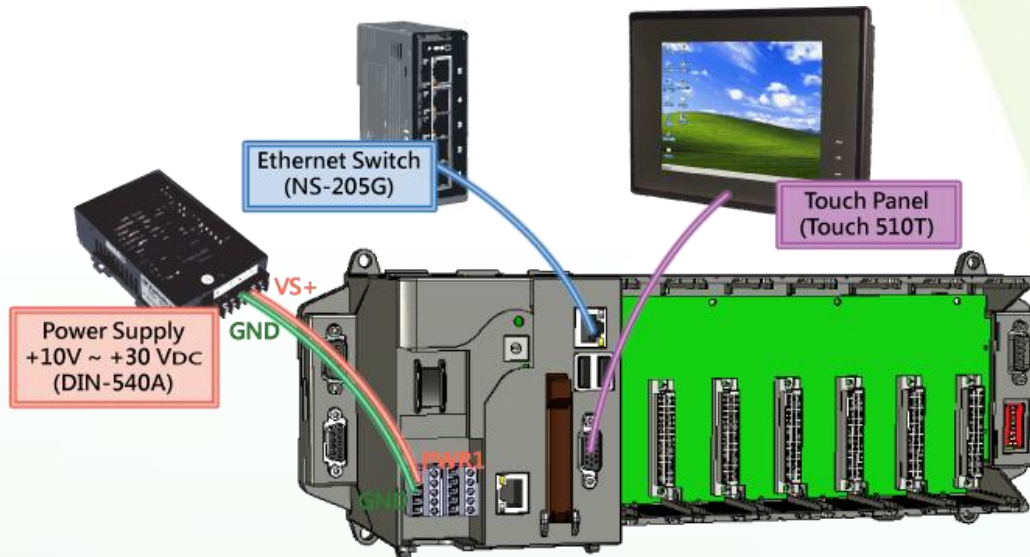

Step 3: Insert and wire the I/O modules

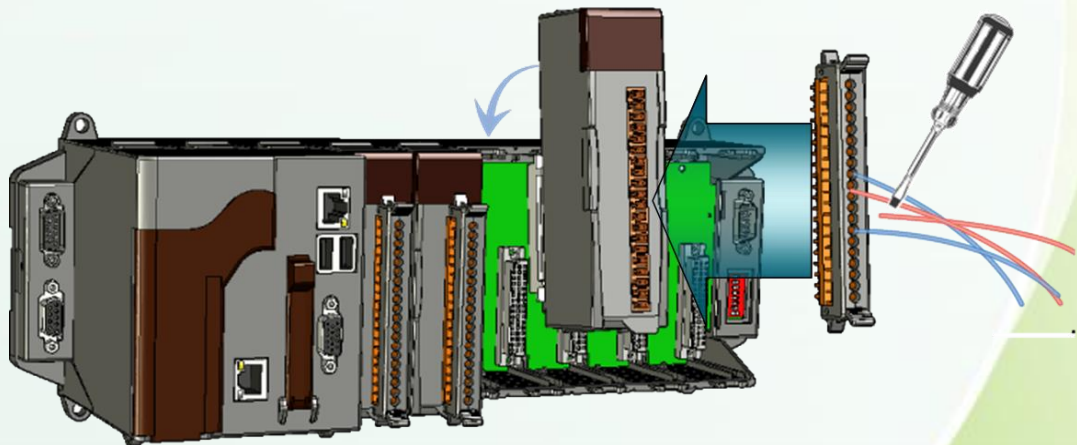

2.2. REGIONAL AND LANGUAGE OPTIONS

Follow these steps below to localize your environment.

Step 1: Go to “Control Panel”



Step 2: Click on “Date, Time, Language, and Regional Options”

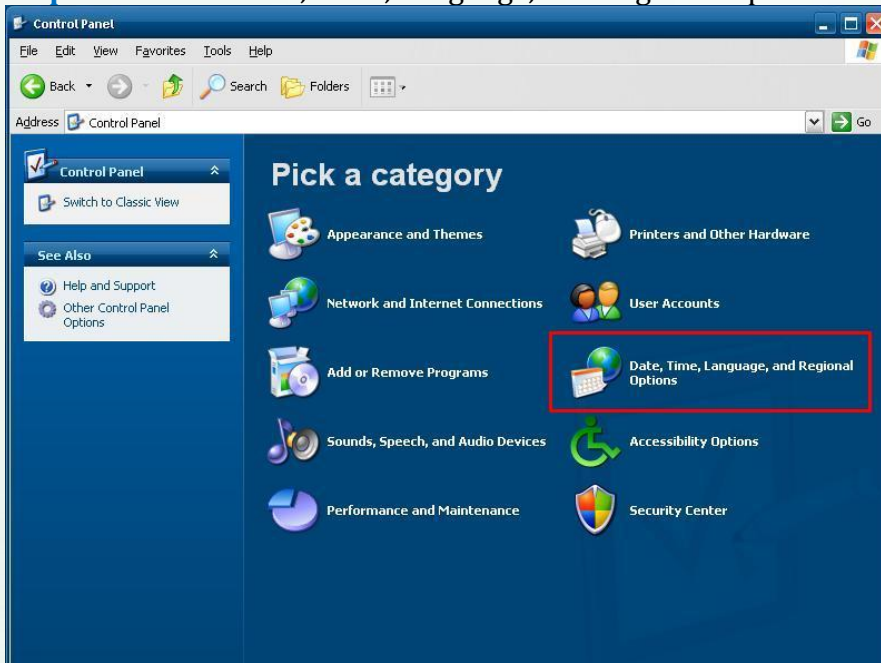

Step 3: Click on “Add other languages”

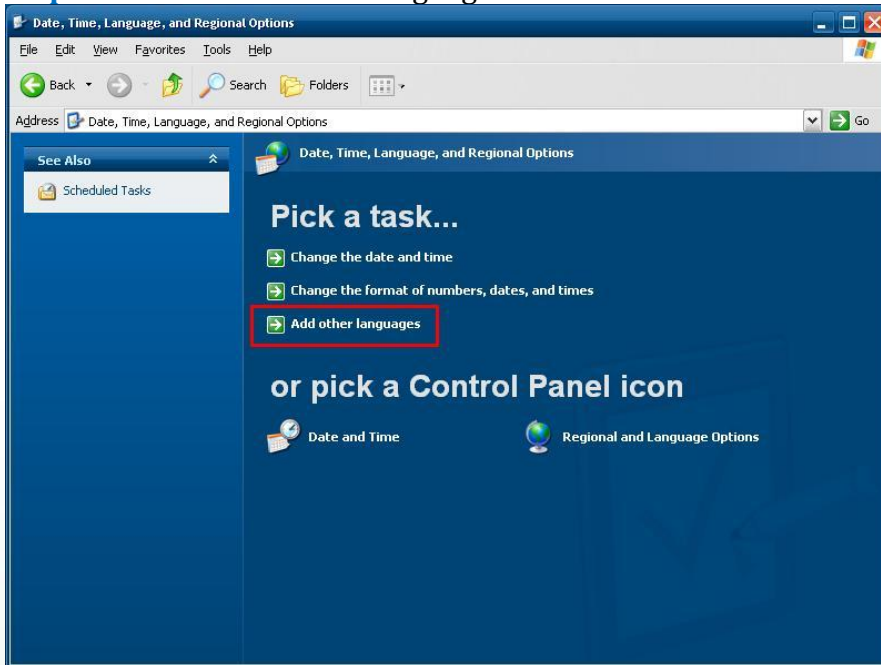

Step 4: Change to your local language in “Language used in menus and dialogs” and then press OK.

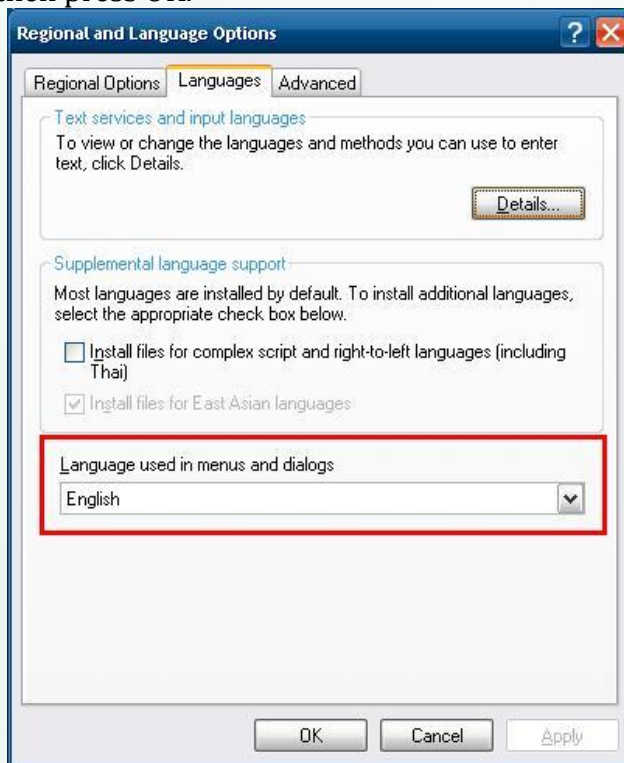

Step 5: Logoff and logon again to make language setting take effect

2.3. GETTING STARTED WITH XP-8000 SOFTWARE

XP-8000 provides EWF mechanism to protect a volume from writes. Of course when shutting down or rebooting the XP-8000, the data in the system memory is lost. Consequently, if you want to install or save your applications, you should disable EWF first. Otherwise, the applications you are going to install will not be saved in XP-8000. Besides, we suggest you should enable EWF after installing and saving your applications. The following instructions will show you how to operate EWF mechanism.

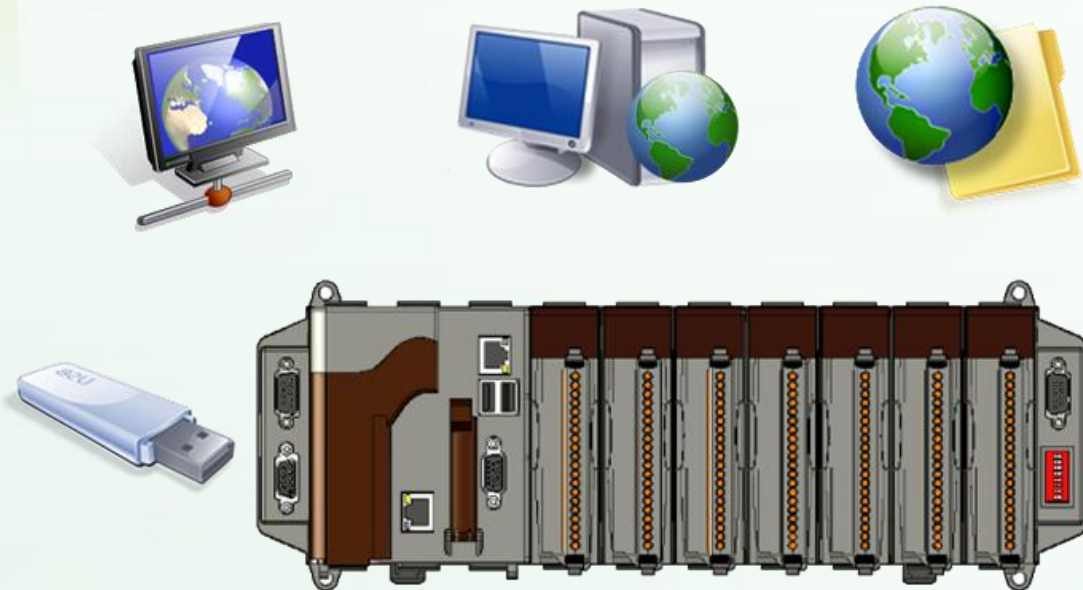

To disable EWF:

First, shut down the device.

Second, rotate the rotary switch to “2” to disable EWE and boot the device.

Last, rotate the rotary switch to “0” to reboot.

- Rotate Rotary Switch to “2” and boot the device

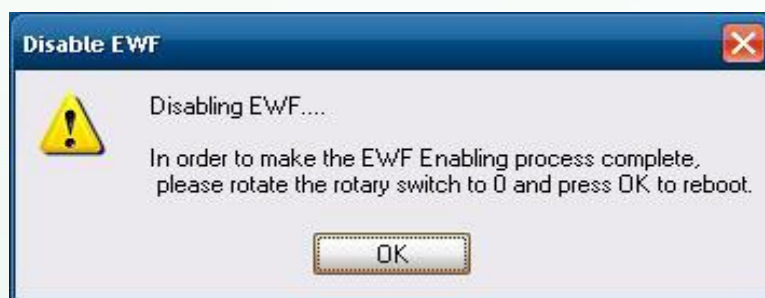

- Rotate Rotary Switch to “0” and click OK then XP-8000 OS will reboot automatically.
If the rotary switch does not rotate to “0”, the warning message will show:





- In order to avoid error of EWF, please reboot your device correctly. The right steps are as following:
Click “Start menu” and select “Restart” to reboot your device. Otherwise, you will get an error message:



Warning:

If EWF is not disabled and XP-8000 suffers sudden power off, the operating system of XP-8000 may be damaged.

To enable EWF:

It's similar to disable EWF.

First, shut down the device.

Second, rotate the rotary switch to "1" to enable EWE and boot the device.

Last, rotate the rotary switch to "0" to reboot.

- Rotate Rotary Switch to "1" and boot the device

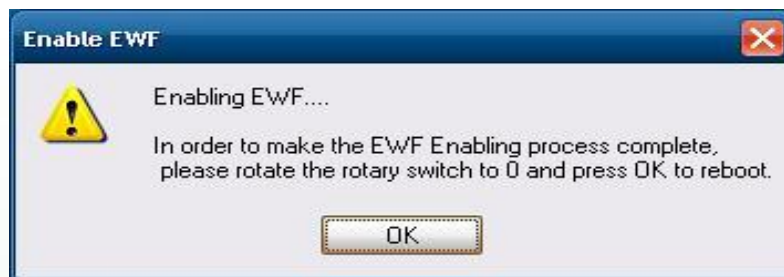

- Rotate Rotary Switch to "0" and click OK then XP-8000 OS will reboot automatically.
If the rotary switch does not rotate to "0", the warning message will show:



Warning

If EWF is not disabled and XP-8000 suffers sudden power off, the operating system of XP-8000 may be damaged.

Suggestion:

Because EWF only takes effect on hard drive C (where the operating system resides), we strongly suggest that you should download your programs to Compact Flash or USB-HDD. It'll prevent XP-8000 from possible damages of operating system.

For more information, refer to section [3.3 How to Change the Status of Enhanced Write Filter \(EWF\)](#).

2.4. RECOVERY THE XP-8000

The XP-8000 restore can be done with the XP-8000 Rescue Disk that can help you easily and quickly restore your XP-8000 OS in case your XP-8000 cannot start or crashed.

Please follow the steps below to recovery your XP-8000

Step 1: Reboot your XP-8000. While rebooting, press “delete” key to enter BIOS setup utility

Step 2: Choose “Advanced BIOS Features” and then press “Enter” key



Step 5: After restarted the device, will enter into XP-8000 Rescue Disk as following. Choose (1), Recover XP-8000 to factory default

```
*****
*
*                XP-8000  Rescue Disk -- Main Menu
*
*****

Choose one of the followings:

<1> Recover XP-8000 to factory default
<2> Upgrade XP-8000 manually
<3> Display Drive [C]
<4> Quit rescue disk and reboot

Enter choice:
```

Step 6: Follow the prompts to complete the installation

Step 7: After finishing recovery, choose (4), Quit Rescue Disk (Refer to above figure.)

Step 8: Repeat step 1 ~ 4 to set "First Boot Device" as "HDD-0", HDD-0 means Built-in flash, and then reboot the XP-8000.

2.5. UPDATING THE XP-8000

XP-8000 update is part of the XP-8000 services to provide additional and more efficient features and functionality for XP-8000 operating system.

There are two ways to update the XP-8000:

i. Service Pack

Each release will contain new features, reliability, application compatibility, security, and more. Before you download any release files, we highly recommend you read the ReadMe.txt file, which contains all of this release contents.

For more information about service pack, please refer to the documents which come with every release.

ii. Reinstall XP-8000

Every time, release the service pack; we will update the XP-8000 OS simultaneously. If you don't like just install service pack, you can reinstall new version XP-8000 OS in your device.

The XP-8000 can be reinstalled with the XP-8000 Rescue Disk. Before reinstalling the XP-8000, make sure the necessary OS image files have been are available on OSIMAGE folder of your CF card.

The OS image files can be obtained at:

ftp://ftp.icpdas.com/pub/cd/xp-8000/os_image

Caution:

Before reinstall XP-8000, please check you have backup your data. For convenience, we recommend you update by using services pack.

Please follow the steps below to reinstall XP-8000

Step 1: Change the boot order. (which is the same as the step 1 to step 4 of above section, 1.3 Recovery The XP-8000.)

Step 2: After restarted the device, will enter into XP-8000 Rescue Disk as following. Choose (2), Upgrade XP-8000 manually

```
*****
*
*           XP-8000  Rescue Disk -- Main Menu
*
*****

Choose one of the followings:

<1> Recover XP-8000 to factory default
<2> Upgrade XP-8000 manually
<3> Display Drive [C]
<4> Quit rescue disk and reboot

Enter choice:
```



Step 3: Choose the *.wim file that you wish to update

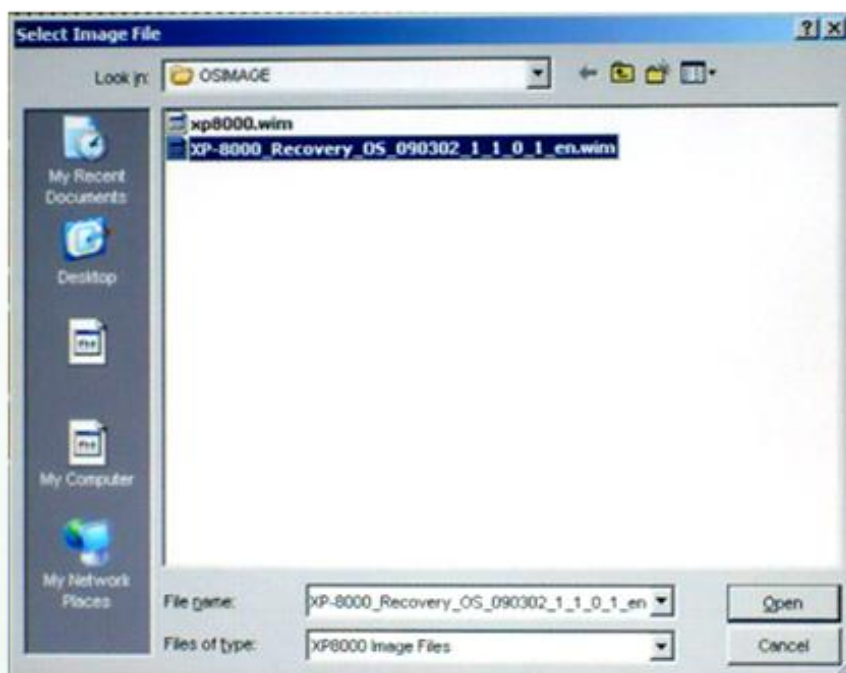

Step4: Follow the prompts to complete the installation

Step 5: After finishing recovery, choose (4), Quit Rescue Disk
(Refer to above figure.)

Step 6: Repeat step 1 ~ 4 to set "First Boot Device" as "HDD-0" and
then reboot the XP-8000.

2.6. XP-8000 RESCUE DISK

The XP-8000 Rescue Disk is XP-8000 features that can help you easily and quickly restore your XP-8000 OS in case your XP-8000 cannot start or crashed and reinstall your XP-8000 update.

The XP-8000 Rescue Disk has the following options:

```
*****
*
*                XP-8000  Rescue Disk -- Main Menu
*
*****

Choose one of the followings:

<1> Recover XP-8000 to factory default
<2> Upgrade XP-8000 manually
<3> Display Drive [C]
<4> Quit rescue disk and reboot

Enter choice:
```

- (1) Recover XP-8000 to factory default t
 - Restore XP-8000 to the factory default settings.
 - For more detailed information, please refer to section 2.4.
- (2) Upgrade XP-8000 manually
 - Reinstall the XP-8000.
 - For more detailed information, please refer to section 2.5.
- (3) Display Drive [C]
 - Display the system storage contents.
- (4) Quit Rescue Disk and Reboot

2.7. RECOVERY RESCUE DISK

The XP-8000 provides Rescue Disk that can help you easily and quickly restore your XP-8000 OS. There is ghost file “Rescue_Disk.gho” can recover Rescue Disk if your Rescue Disk crashed.

The ghost file can be obtained at:

ftp://ftp.icpdas.com/pub/cd/xp-8000/rescue_disk

Note:

Below example is used “Symantec Norton Ghost32 V.11” (The “Symantec Norton Ghost V.11” or above version are recommend) as a demonstration how to do recovery the Rescue Disk.

Please follow below steps to recover Rescue Disk.

1. Open “Symantec Norton Ghost32 V.11” software and click ‘OK’

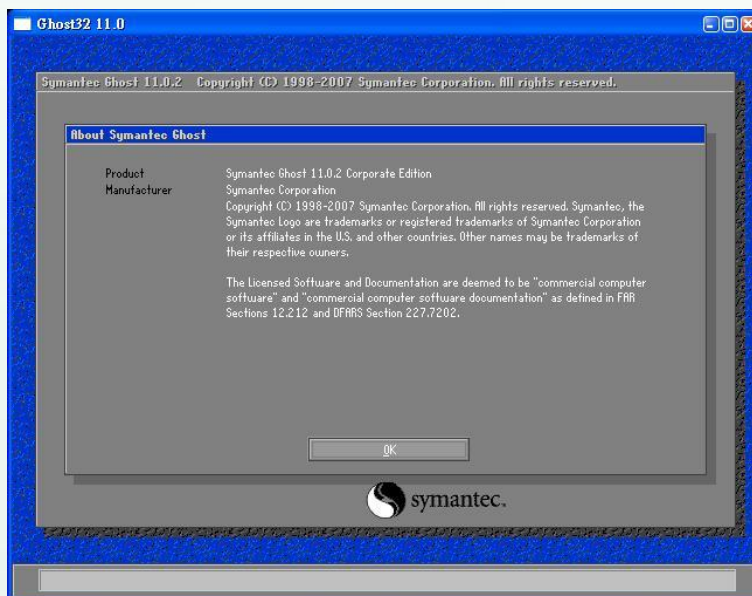

2. Select “Local - Disk - From Image” from function menu

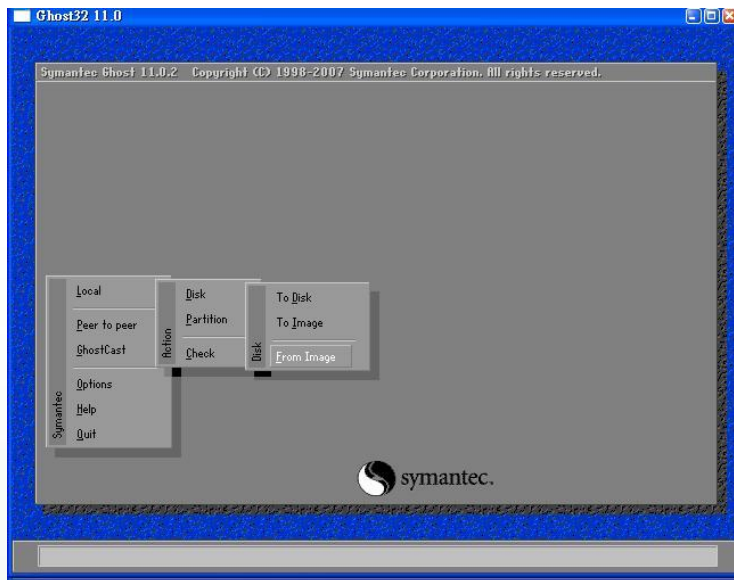

3. Select the “Rescue_Disk.gho” file

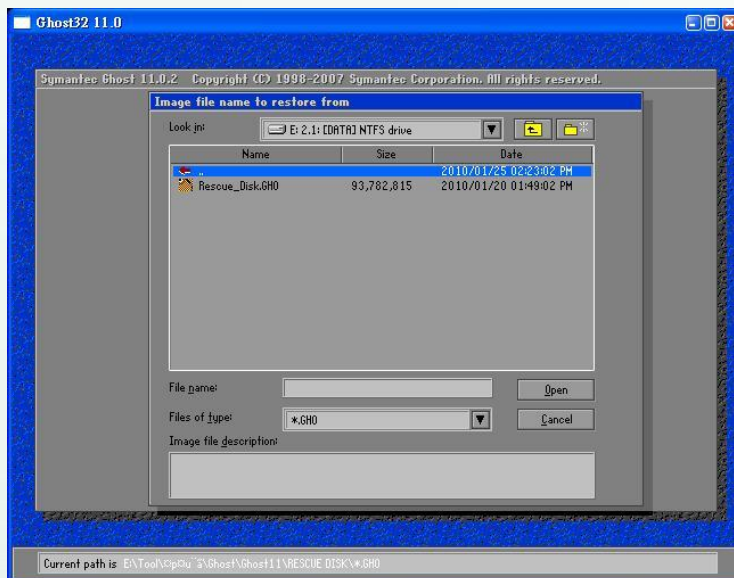

4. Select the destination to CF card and click 'OK'

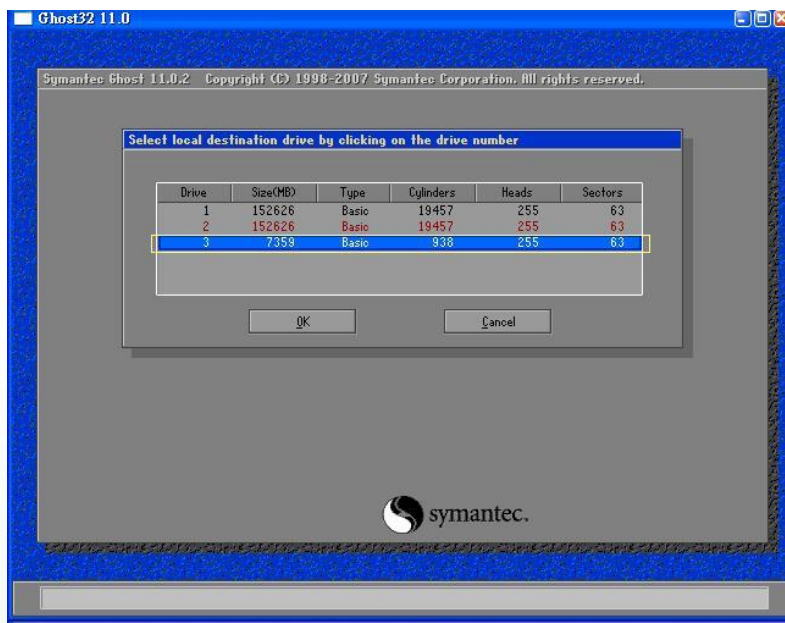

5. Recovery the "Rescue_Disk.gho" file into CF card and click 'OK'

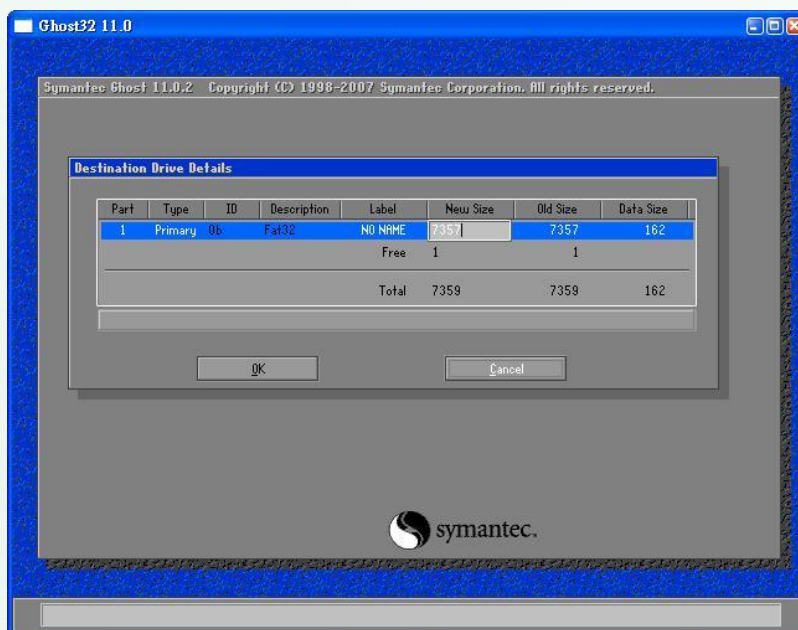

6. Recovering Rescue Disk

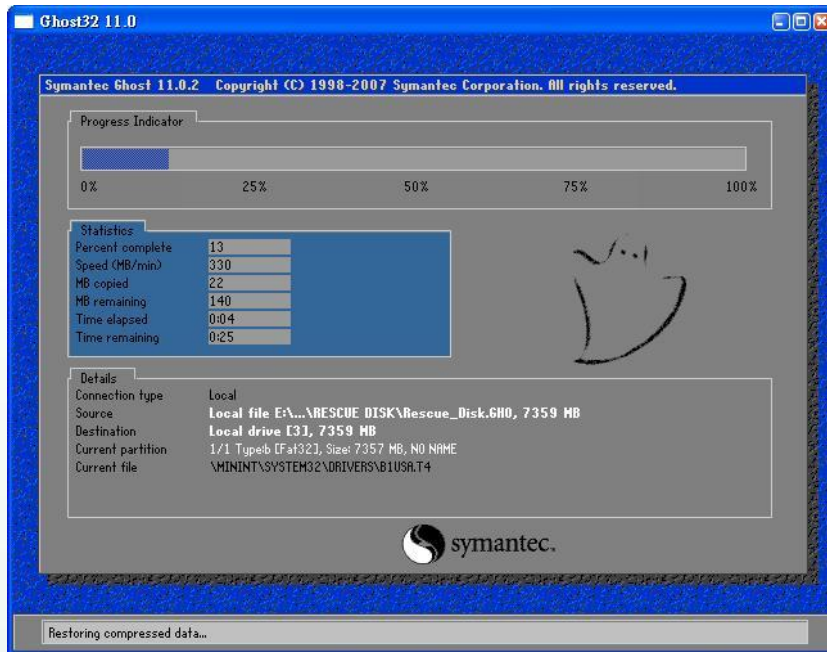

7. So far, Rescue Disk has been done, but it doesn't contain any OS image. Therefore, you should copy an OS image to OSIMAGE folder of the Rescue Disk.

The OS image files can be obtained at:

ftp://ftp.icpdas.com/pub/cd/xp-8000/os_image

For more information of reinstall OS, please refer to ii. Reinstall XP-8000 of [Updating the XP-8000](#)



Industrial Communication Product

3. Security Issues

Before you using XP-8000 to develop your applications, there are many security issues you should know.

The default settings of XP-8000 about security as followings:

Security Items	Default Settings
Auto logon	Enable
Firewall	Enable
Enhanced Write Filter (EWF)	Enable
Internet Information Service (IIS)	Enable
SQL Server	Enable

The default accounts and passwords of XP-8000:

Item	Account	Password
Windows Embedded Standard 2009	Administrator	icpdas
FTP Server (IIS)	anonymous	N/A
SQL Server	sa	icpdas

3.1. HOW TO CHANGE THE SETTING OF AUTO LOGON

Instead of waiting for a user to enter their name and password, auto logon logs on Windows as the specified user automatically.

Default of auto logon is “Enabled.”

How to disable the setting of Auto logon? Followings are the steps.

1. Run the command: “control userpasswords2”.
2. Clear the check box of “Users must enter a user name and password to use this computer.” Press OK to disable auto logon.



- The default account and password are “Administrator” and “icpdas” respectively. You can configure your accounts and passwords through “User Accounts” in the “Control Panel”

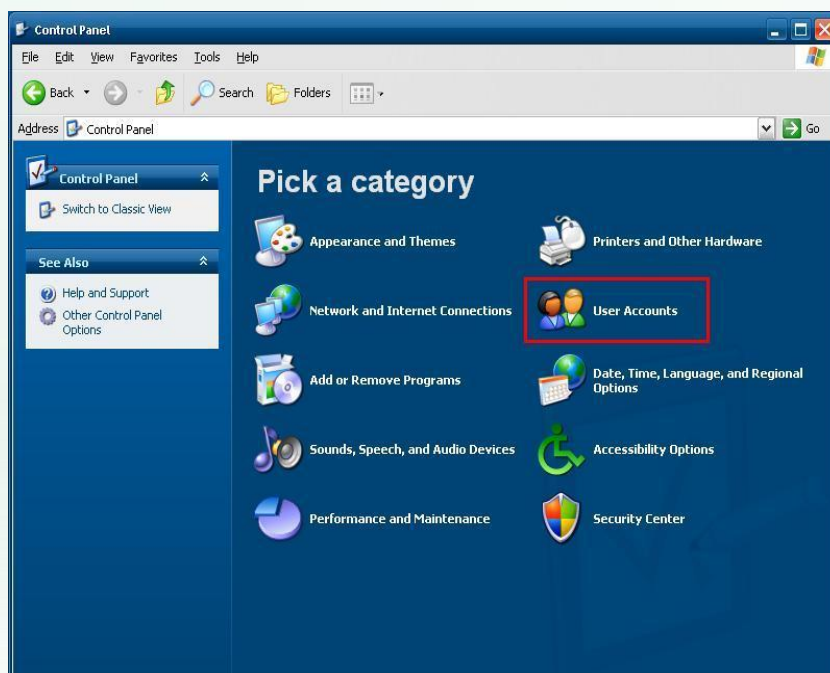

3.2. HOW TO CONFIGURE THE SETTINGS OF FIREWALL

ICP DAS enables the firewall as a default.

(Enabling the firewall may block the connections of internet communications)

Default of the firewall is “On.”

How to configure the settings of the firewall? Followings are the steps.

1. Click on “Security Center” in the “Control Panel”



2. Click on the “Security Center”

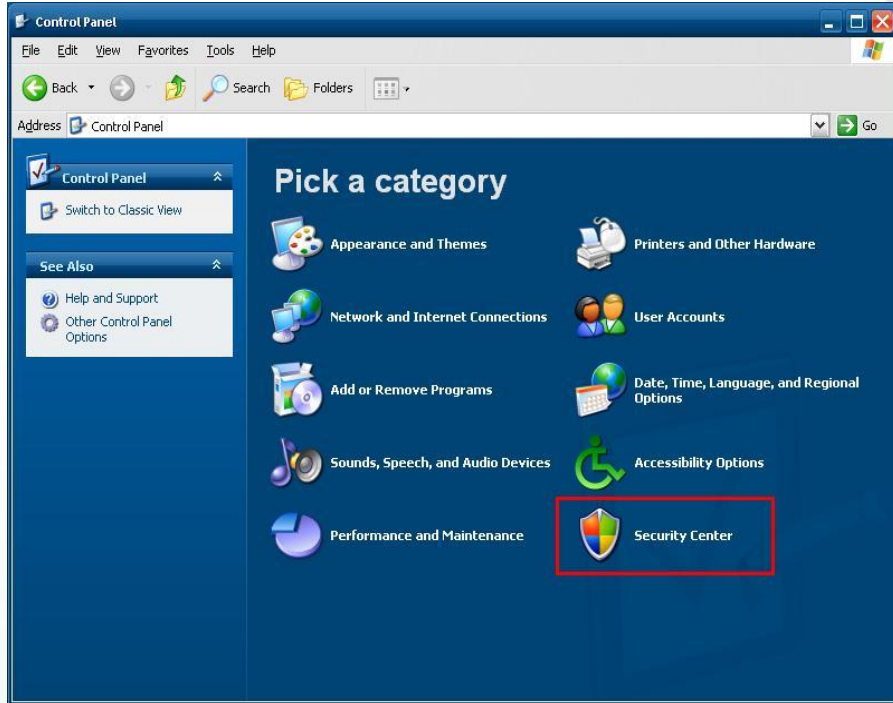

3. Click on the “Windows Firewall” to have your own settings.



3.3. HOW TO CHANGE THE STATUS OF ENHANCED WRITE FILTER (EWF)

To control the status of EWF, use the rotary switch to change EWF state.

- Rotate the Rotary Switch to “0” :
To obtain the current status of EWF.
- Rotate the Rotary Switch to “1” :
To enable EWF.
- Rotate the Rotary Switch to “2” :
To disable EWF.

Note:

Only the disk drive (usually, c:\) that OS resides can use the feature of EWF.

See the details on MSDN: [EWF Manager Commands](#)



EFW Operation Mechanism

EFW prevents disk from being changed. In cases of maintenance, the disk must be updated to your desired changes.

This contains three steps: (1) disabling EWF, (2) updating, and (3) re-enabling EWF.

To disable EWF:

First, shut down the device.

Second, rotate the rotary switch to “2” to disable EWE and boot the device.

Last, rotate the rotary switch to “0” to reboot.

- Rotate Rotary Switch to “2” and boot the device

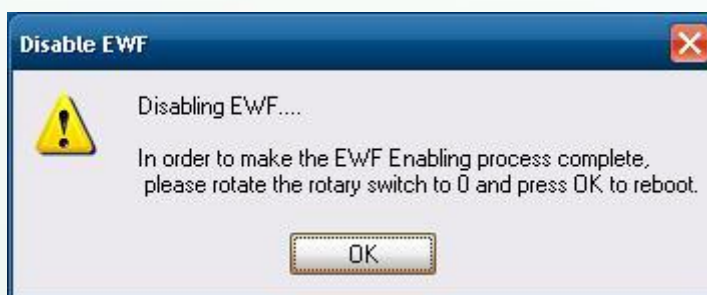

- Rotate Rotary Switch to “0” and click OK then XP-8000 OS will reboot automatically.
If the rotary switch does not rotate to “0”, the warning message will appear:



Warning

If EWF is not disabled and XP-8000 suffers sudden power off, the operating system of XP-8000 may be damaged.

To enable EWF:

It's similar to disable EWF.

First, shut down the device.

Second, rotate the rotary switch to "1" to enable EWE and boot the device.

Last, rotate the rotary switch to "0" to reboot.

- Rotate Rotary Switch to "1" and boot the device

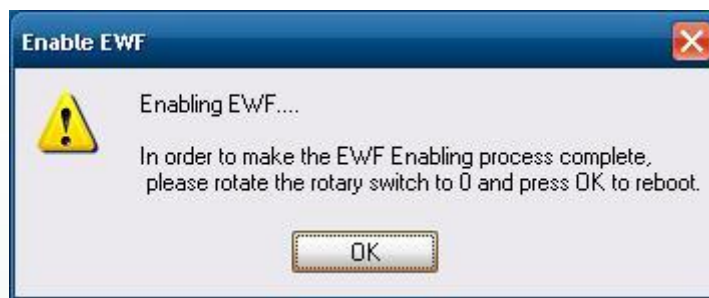

- Rotate Rotary Switch to "0" and click OK then XP-8000 OS will reboot automatically.
If the rotary switch does not rotate to "0" the warning message will appear.



Warning

If EWF is not disabled and XP-8000 suffers sudden power off, the operating system of XP-8000 may be damaged.

Suggestion:

Because EWF only takes effect on hard drive C (where the operating system resides), we strongly suggest that you should download your programs to Compact Flash or USB-HDD. It'll prevent XP-8000 from possible damages of operating system.

To obtain the current status of EWF:

First, shut down the device.

Then rotate the rotary switch to “0” and boot the device.

➤ EWF Enable :

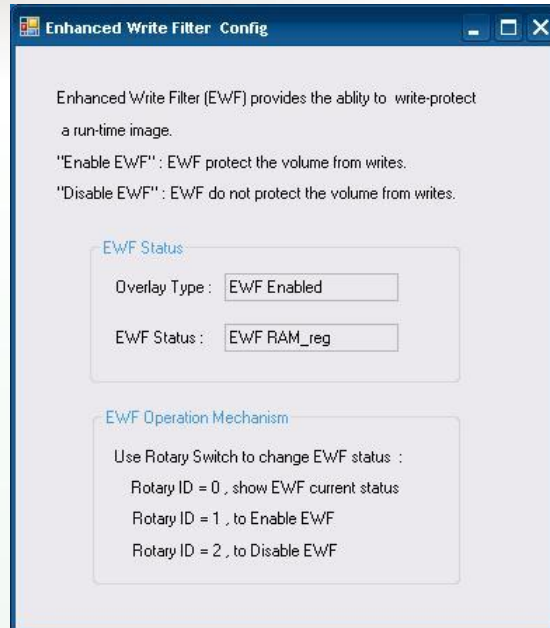

➤ EWF Disable:

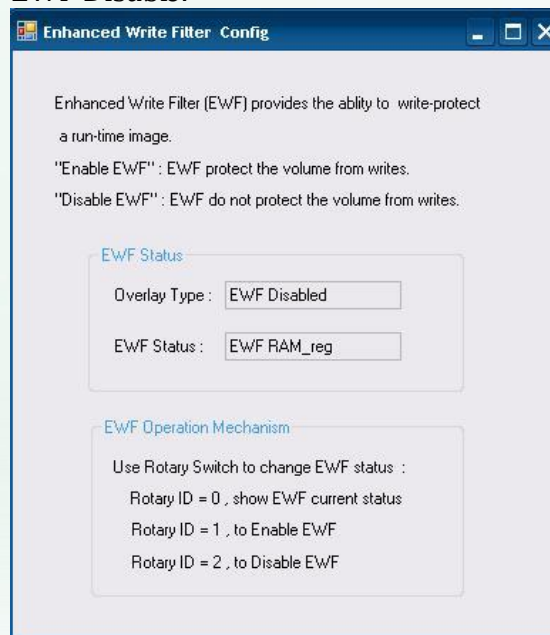

Introduction to EWF (data source: MSDN)

Generally Speaking, EWF prevents OS image from being altered or corrupted by redirecting all write operations to the system memory or another disk. Of course when shutting down or rebooting the XP-8000, the data in the system memory is lost. The XP-8000 use random access memory (RAM) as an overlay while EWF is enabled.

EWF provides a means for protecting a volume from writes. All writes to an EWF-protected volume are redirected to an overlay. These writes are stored in the overlay and made available as part of the volume. In this way, it feels like that the volume is writeable. The overlay may exist either on disk or in RAM. If desired, the data stored in the overlay may be committed to the protected volume. The following figure is an overview of EWF.



For more information, please refer to MSDN: [Enhanced Write Filter](#)



How to use EWF commands:

To control the status of EWF, use the EWF Manager Command “EWFMgr”.

- To see the status of EWF:
ewfmgr c:
- To enable EWF:
ewfmgr c: -enable (it is effective after rebooting.)
- To disable EWF:
ewfmgr c: -commitanddisable -live

Note:

Only the disk drive (usually, c:\) that OS resides can use the feature of EWF.

See the details on MSDN: [EWF Manager Commands](#)

3.4. HOW TO DISABLE ANONYMOUS ACCOUNT OF THE FTP SERVER

Microsoft Internet Information Service (IIS) is installed in the XP-8000 and enabled as default. The IIS includes FTP Server and Web Server. It is convenient to use onymous FTP access as default. However, it may cause some security problems too.

To disable anonymous account of the FTP Server, follow the steps:

1. Right click on the icon of “My Computer” and then click on “Manage”.

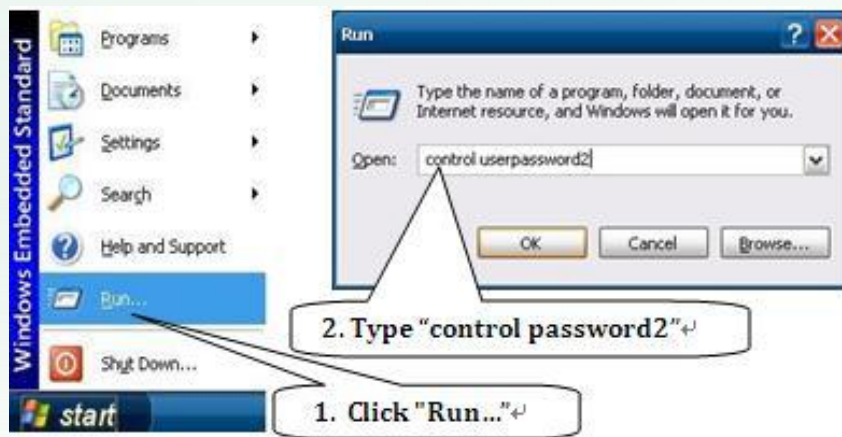
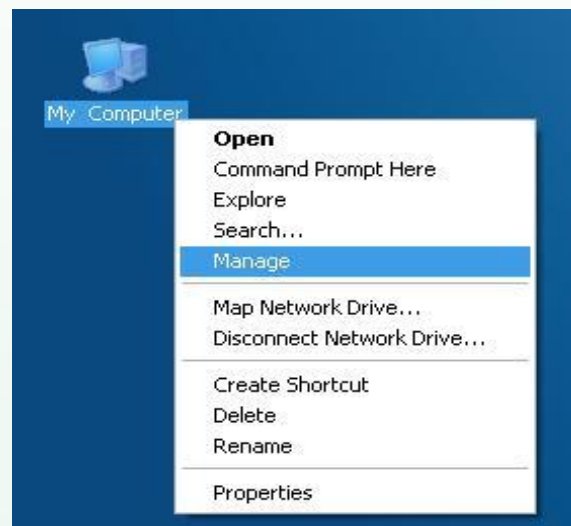

2. Right click on the “Default FTP Site” and then click on “Properties”

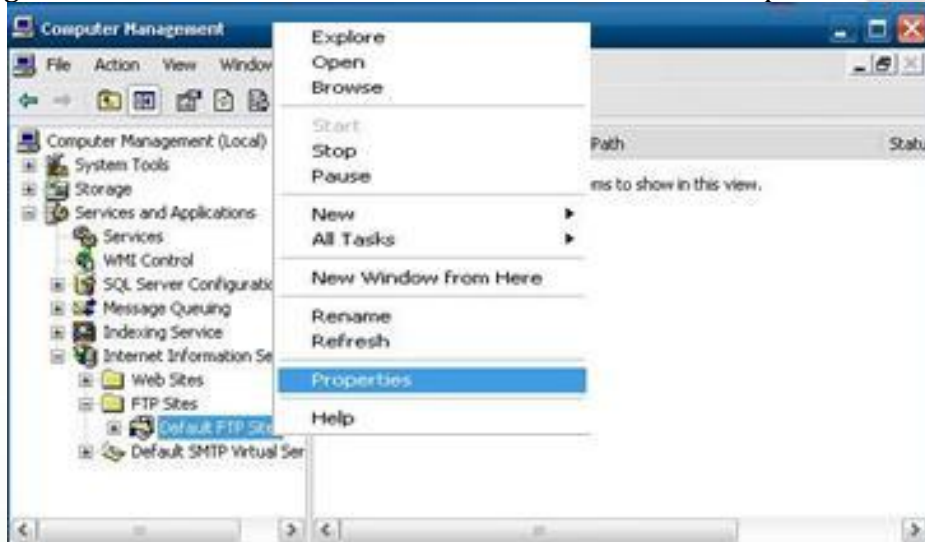

3. In the tab of “Security Accounts”, clear “Allow Anonymous Connections”, and then press OK.

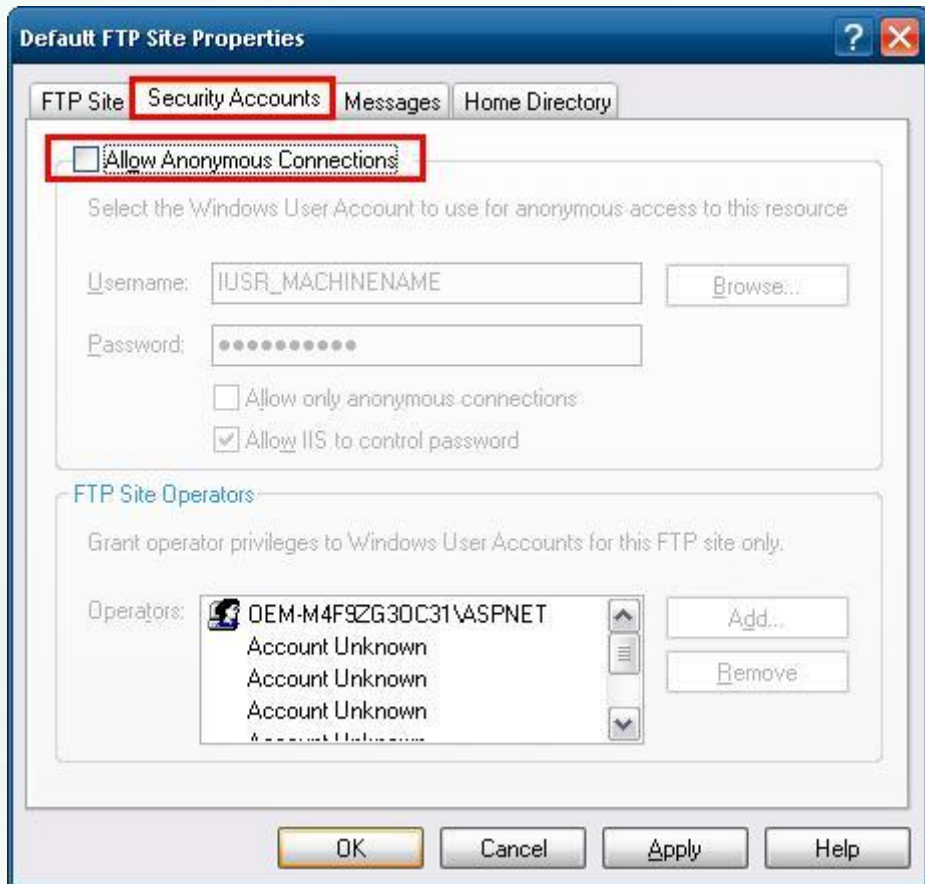

4. After disabling anonymous FTP access, your FTP accounts and passwords are the same as the Windows accounts. You can configure your Windows accounts and passwords through “User Accounts” in the “Control Panel”

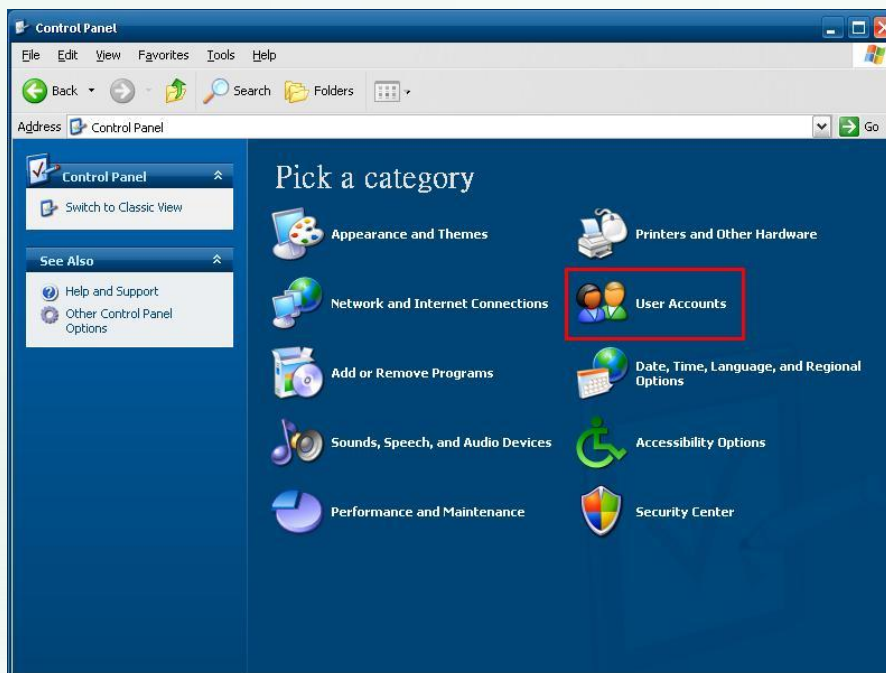

3.5. HOW TO CONFIGURE THE SECURITY SETTINGS OF SQL SERVER

XP-8000 has SQL Server 2005 Express Edition running as default. The default account and password are “sa” and “icpdas” respectively. To improve security of the SQL Server, it is necessary to change the account and the password.

Use Microsoft SQL Server Management Studio Express to configure the settings.

1. Start SQL Server Management Studio Express.



2. Connect to Server. Default account is “sa”; default password is “icpdas”



3. Add a new login account by right clicking on Logins directory in the Object Explorer window

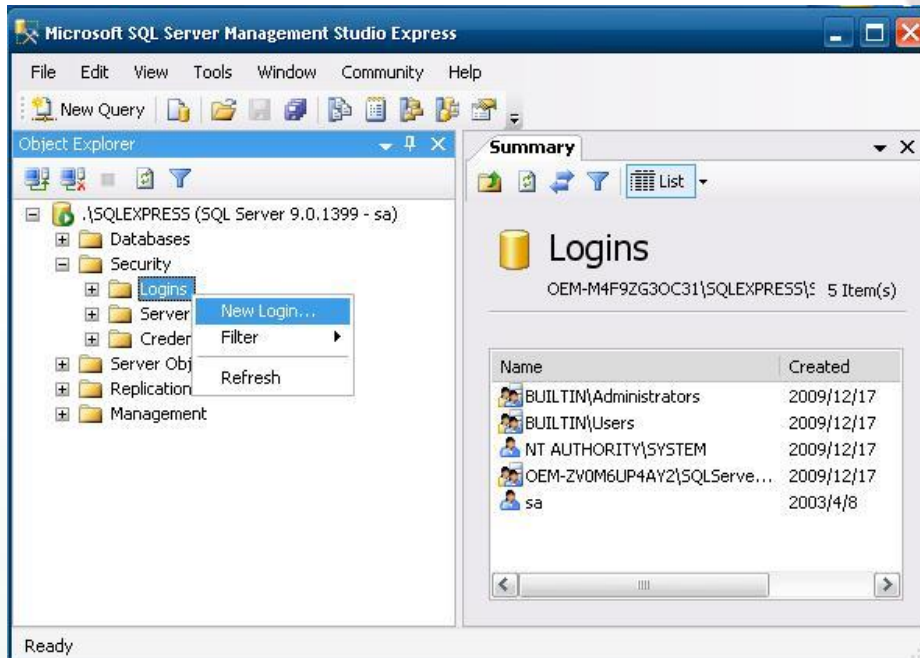

4. Or you can change the password of a login account by right clicking on it and then click on Properties

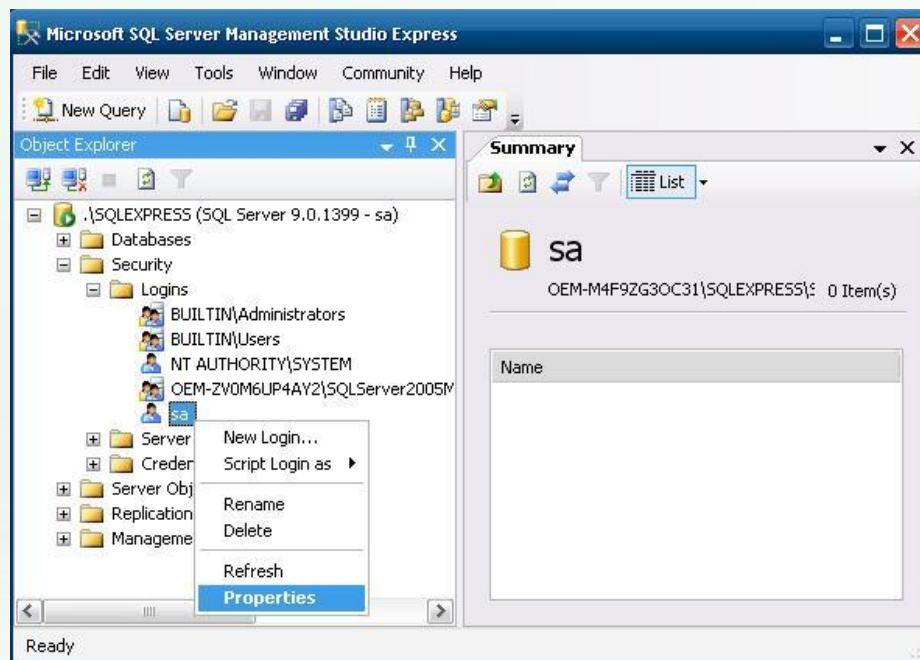



Industrial Communication Products

4. Your First Program

This chapter provides basic and necessary information to start developing your own program

4.1. SETTING UP THE DEVELOPMENT ENVIRONMENT

Before creating your first program, you must first ensure that you have the necessary development tools and the required corresponding SDKs are installed on your PC.

Integrated Development Environment (IDE) Tools

The XP-8000 can be developed using several development tools. Although the development tools which are compatible with XP Professional can also be used in XP-8000, the following development tools are recommended for application development:

- Borland C++ Builder
- Borland Delphi
- Microsoft Visual Studio 6.0 (for Visual C++ and Visual Basic)
- Microsoft Visual Studio 2005/2008 (for Visual C#.NET and Visual Basic.NET)
- We have XP-8000 SDK for these development tools.

API and SDKs

Several SDKs are provided for XP-8000, it enables you to quickly and efficiently develop your own programs. These SDKs are located at:

CD:\ICPDAS\XP-8000\SDK
<ftp://ftp.icpdas.com/pub/cd/xp-8000/sdk>

We will continue to add additional functions on XP-8000 SDKs,
For details of XP-8000 Standard API reference, please refer to:
CD:\ICPDAS\XP-8000\Document
<ftp://ftp.icpdas.com/pub/cd/xp-8000/document>

And demo programs of frequently-used APIs, please refer to:
CD:\ICPDAS\XP-8000\Demo
<ftp://ftp.icpdas.com/pub/cd/xp-8000/demo>



4.2. CREATING YOUR FIRST PROGRAM

ICP DAS provides SDKs to help you develop your application. The following sections briefly explain how to build your first program of different development tools and different programming languages.

Here we demonstrate how to build your first program with Microsoft Visual C++ 6.0 in section 4.2.1 and Microsoft Visual Basic 6.0 in section 4.2.2.

4.2.1. Your First Visual C++ Program

This section help you start developing applications by using MFC AppWizard. Follow these steps to create a new program running on the XP-8000.

Step 1: Start Microsoft Visual C++ 6.0

Step 2: On the File menu, click New
The New dialog box appears.

Step 3: In the New dialog box, choose the project type you want to develop. And specify Project name and Location. For example, if you want to develop a MFC application, choose “MFC AppWizard (exe)”.

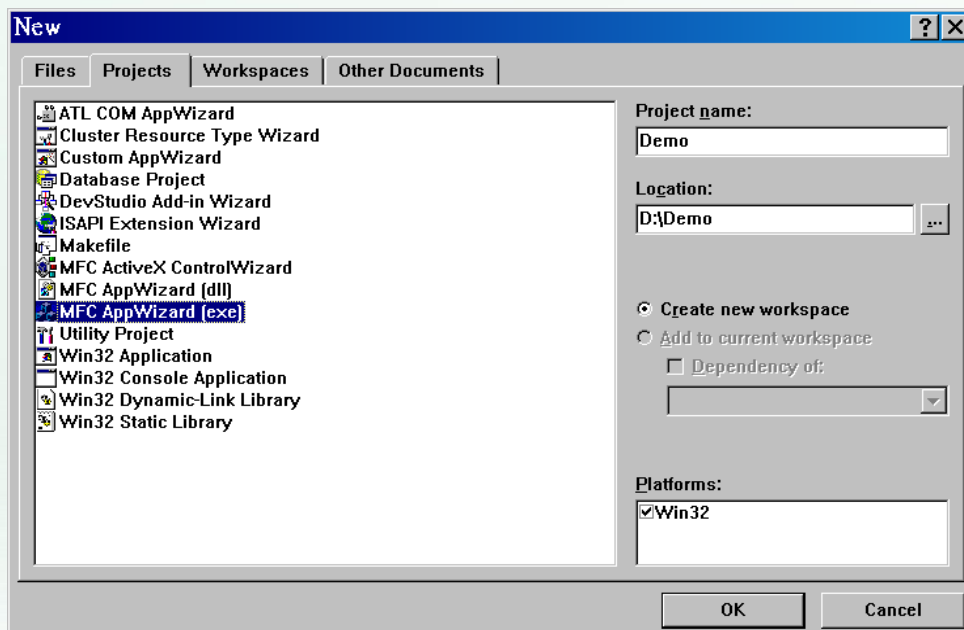

Step 4: Configure the settings of the project. Just follow the MFC AppWizard, as the following figures show

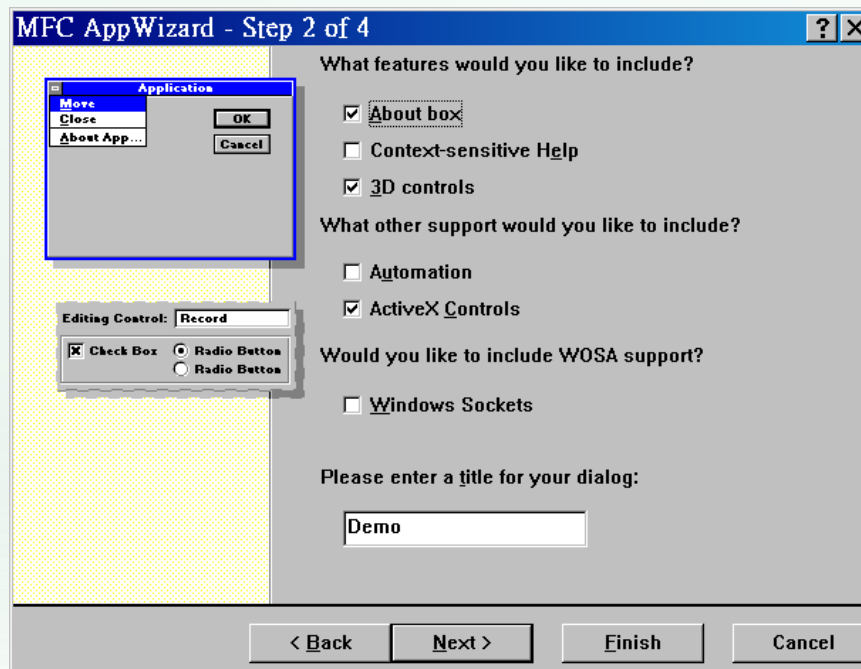
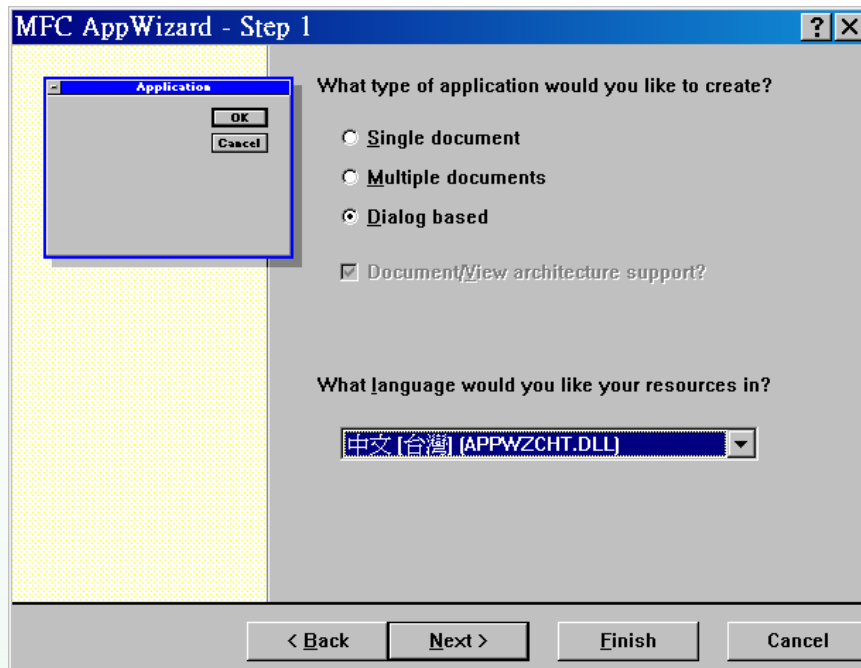

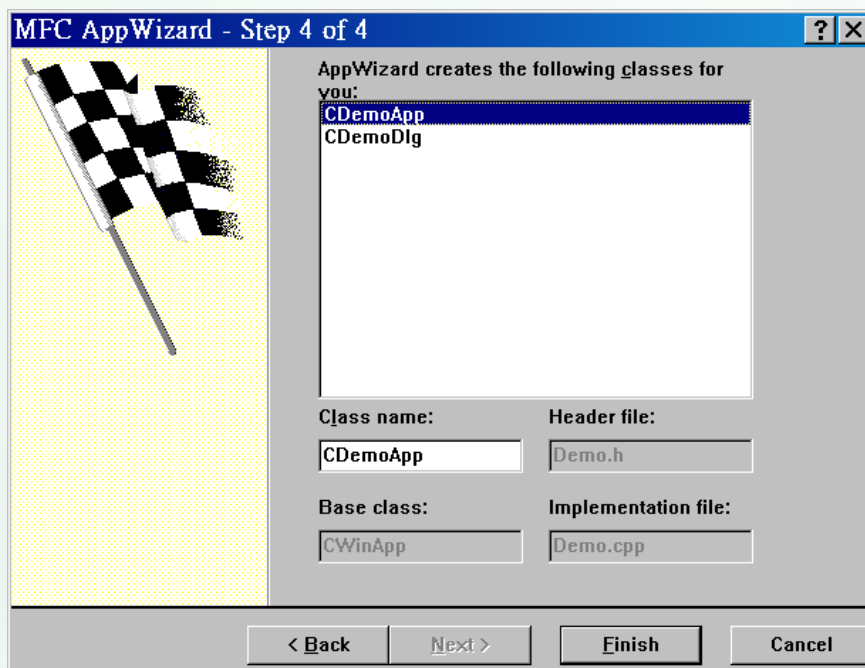
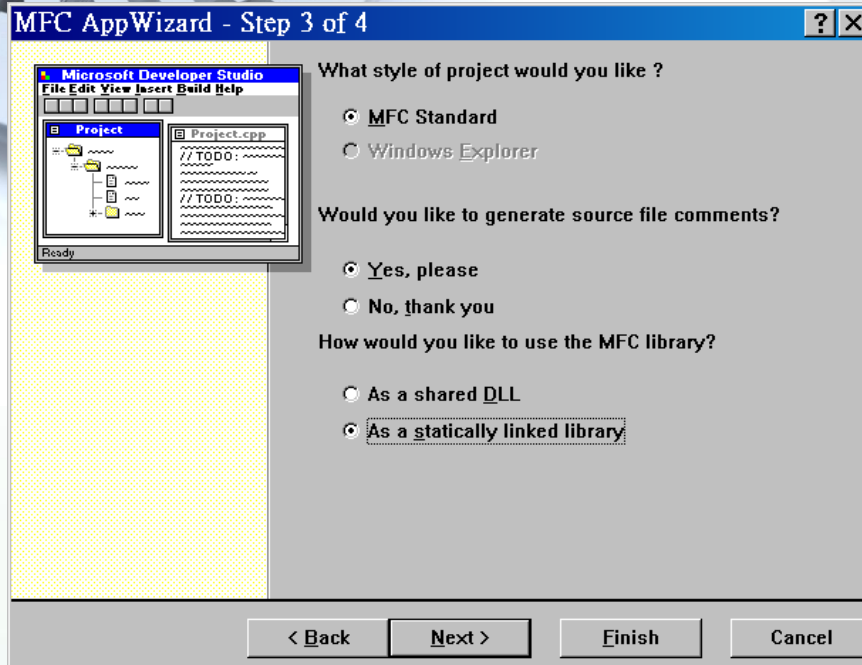

Step 5: Add XPacSDK.lib to the project.
Project -> Add To Project -> Files...

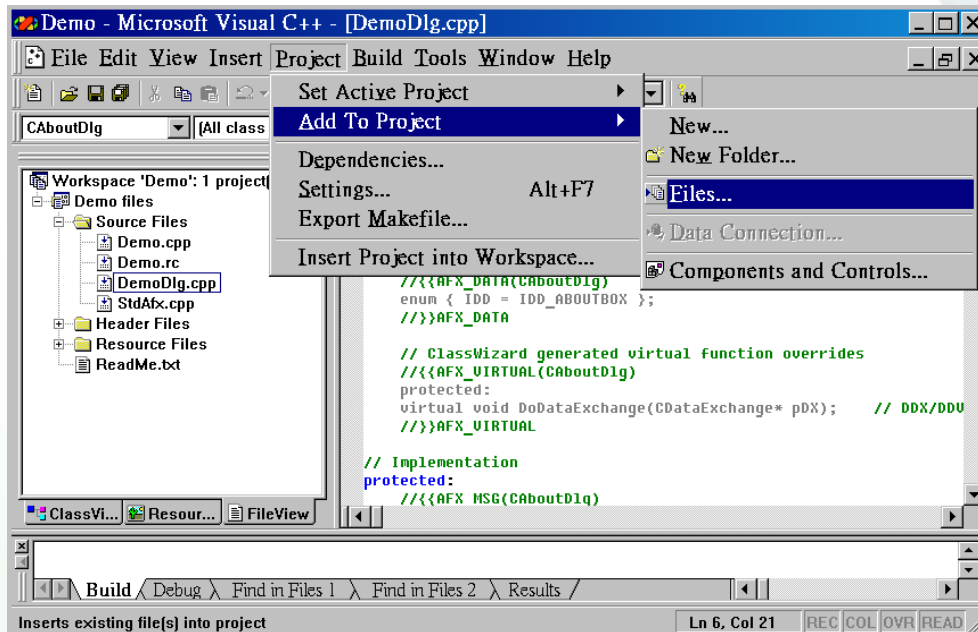

Step 6: #include "XPacSDK.h" in the DemoDlg.cpp file

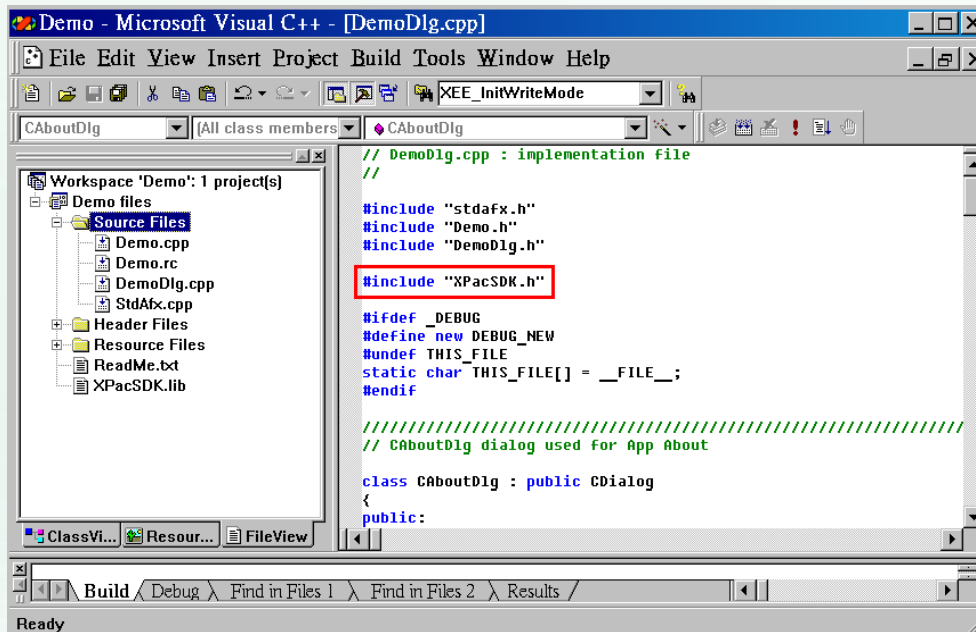

Step 7: Then you can use XPacSDK to develop Visual C++ applications on the XP-8000. Here we take I-8051W, a Digital Input (DI) module, for example to demonstrate How powerful XPacSDK is.

Step 8: Put the I-8051W in the slot 1 of the XP-8000. And connect the GND pin and the DI3 pin to turn on the digital input value of the channel 3.

You can see the detail information on the web site of ICP DAS :

[http://www.icpdas.com/products/Remote IO/i-8ke/i-8051w.htm](http://www.icpdas.com/products/Remote%20IO/i-8ke/i-8051w.htm)

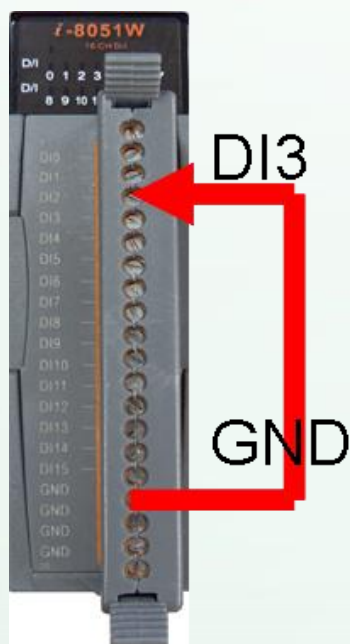

Step 9: Make a simple User Interface in the Dialog as the following figure shows.

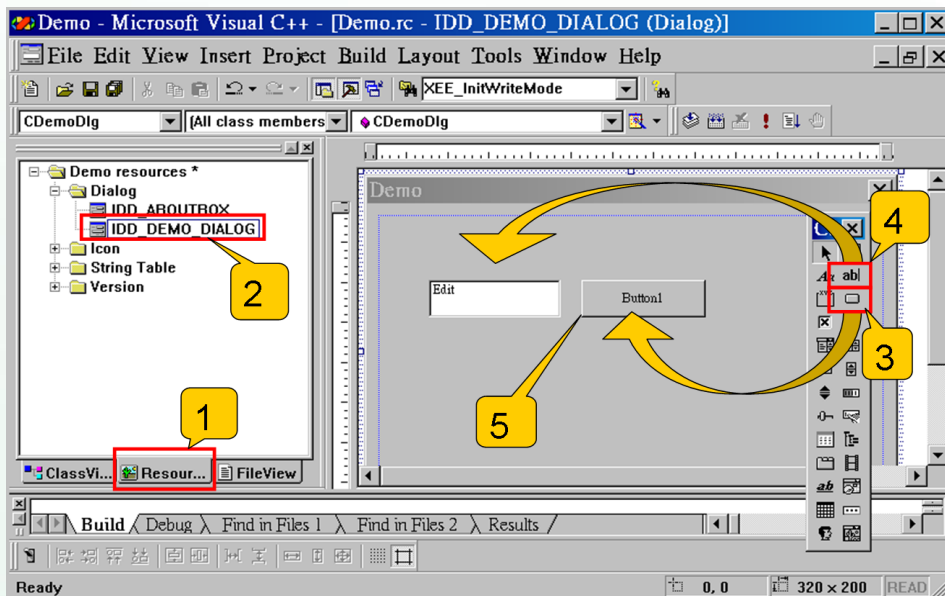

1. Click on the Resource View
2. Double click on the Dialog item
3. Draw a Button
4. Draw an Edit Box
5. Double click on the Button to write the On-Click Event

Step 10: Write the content of the On-Click function. You can see that simply writing one line make us have the digital input value read back. The line for reading digital value back is:

```
pac_ReadDI(h, 1, 16, &DI_Value);
```

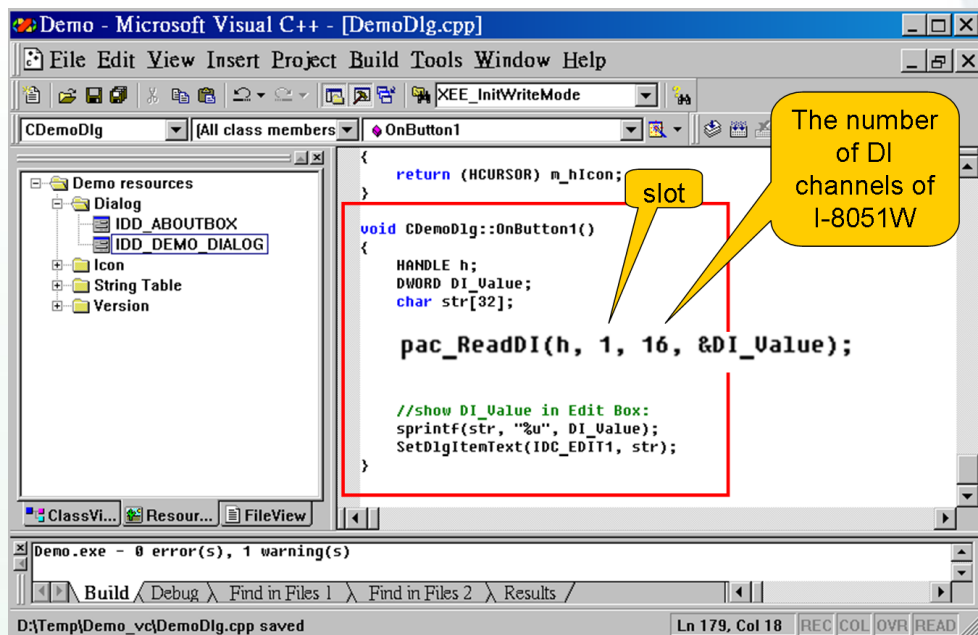

Note:

The arguments of the above example are described here:
h: handle of UART. The I-8K series I/O modules ignore this argument.

1: the slot which I-8051W plugs in.

16: the number of total DI channels. In the case of I-8051W, the number of total DI channel is 16.

DI_Value: the variable to read back the DI value.

See [xPAC_Standard_API_manual.pdf](#) for more information.

[xPAC_Standard_API_manual.pdf](#) can be found in the companion CD or the FTP site of ICP DAS.

Step 11: The snapshot of the demo program

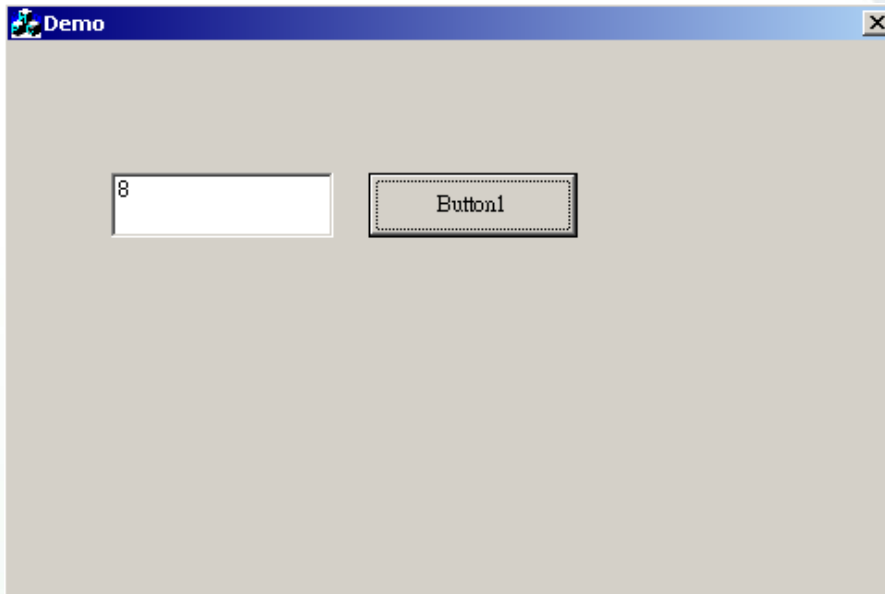

Note:

The read back DI value is the binary representation of the total 16 DI channels. If DI3 turns on, the read back DI value is "0000,0000,0000,1000" of binary representation, that is, DI is 8 as its decimal form. Users can use `pac_GetBit(DI_Value, index)` to get the DI value of a specified channel. See `xPAC_Standard_API_manual.pdf` for details.

To execute the program you build, be sure to put `XPacSDK.dll` and the program's `.exe` file in the same directory.

4.2.2. Your First Visual Basic Program

This section help you start developing applications by using Visual Basic. Follow these steps to create a new program running on the XP-8000.

Step 1: Start Microsoft Visual Basic 6.0. In the New Project dialog, choose the Standard EXE



Step 2: On the Project menu, click Add Module

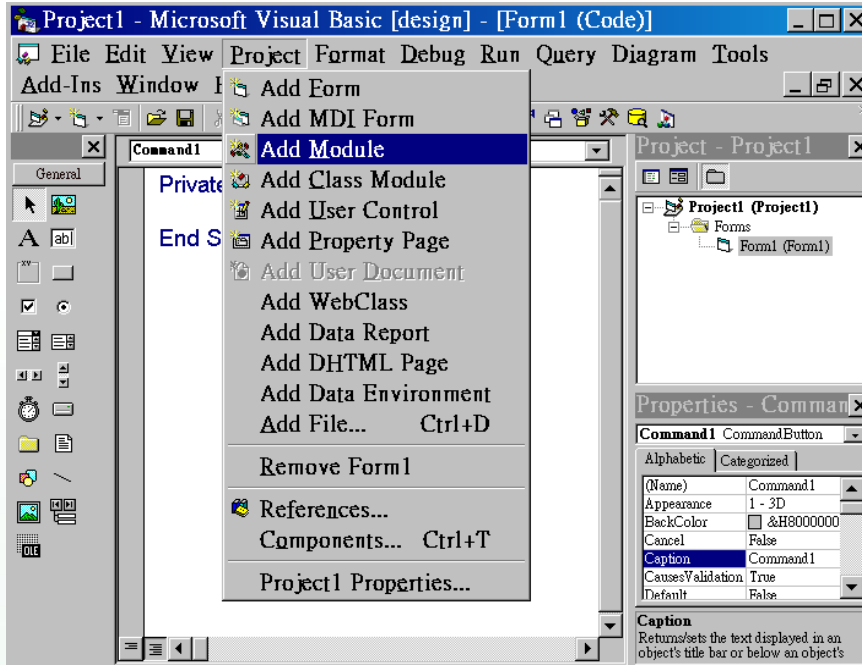

Step 3: In the Add Module dialog box, click on the Existing tab, add the module "XPacSDK.bas"

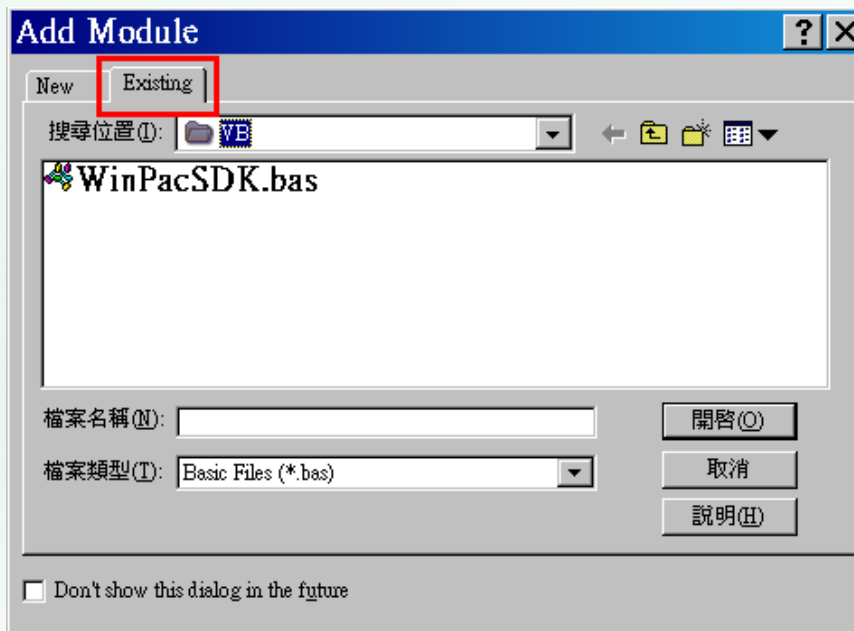

Step 4: Then you can use the XPacSDK that ICP DAS provides to develop Visual Basic applications on the XP-8000. Here we take I-8051W, a Digital Input (DI) module, for example to demonstrate How powerful XPacSDK is.

Step 5: Put the I-8051W in the slot 1 of the XP-8000. And connect the GND pin and the DI3 pin to turn on the digital input value of the channel 3

You can see the detail information on the web site of ICP DAS :

http://www.icpdas.com/products/Remote_IO/i-8ke/i-8051w.htm

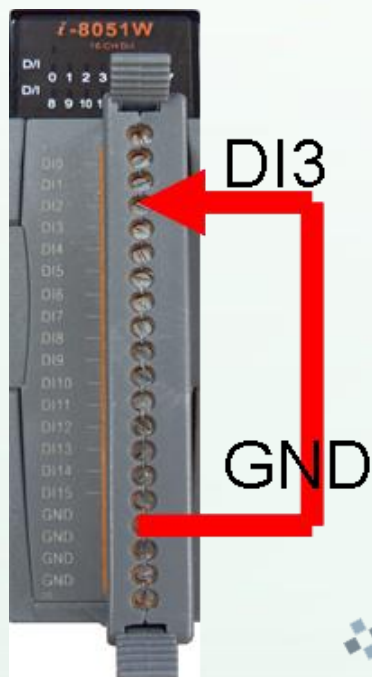

Step 6: Make a simple User Interface in the Dialog as the following figure shows

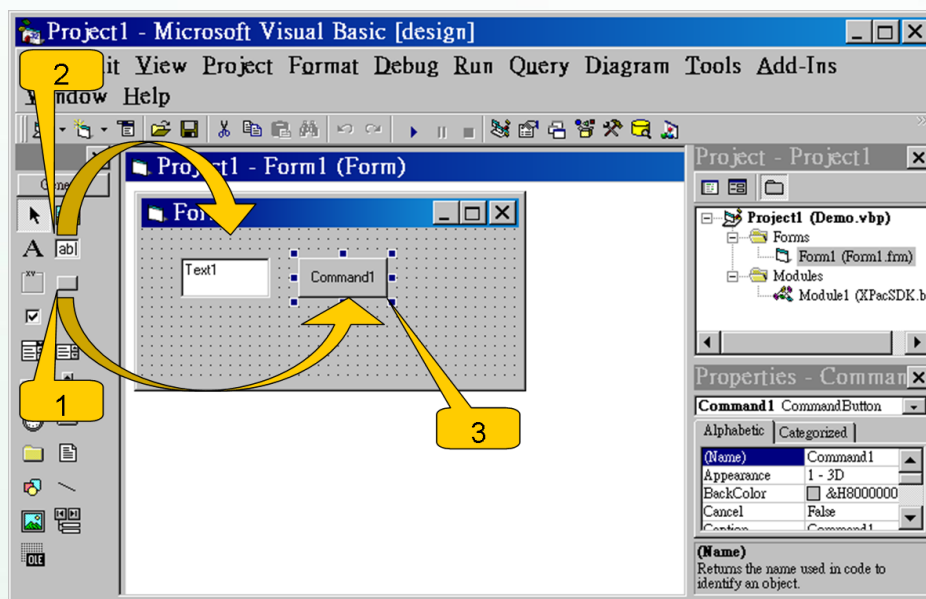

1. Draw a Button.
2. Draw an Text Box.
3. Double click on the Button to write the On-Click Event.

Step 7: Write the content of the On-Click function. You can see that simply writing one line make us have the digital input value read back. The line for reading digital value back is:

```
return_flag = pac_ReadDI(h, 1, 16, DI_Value)
```

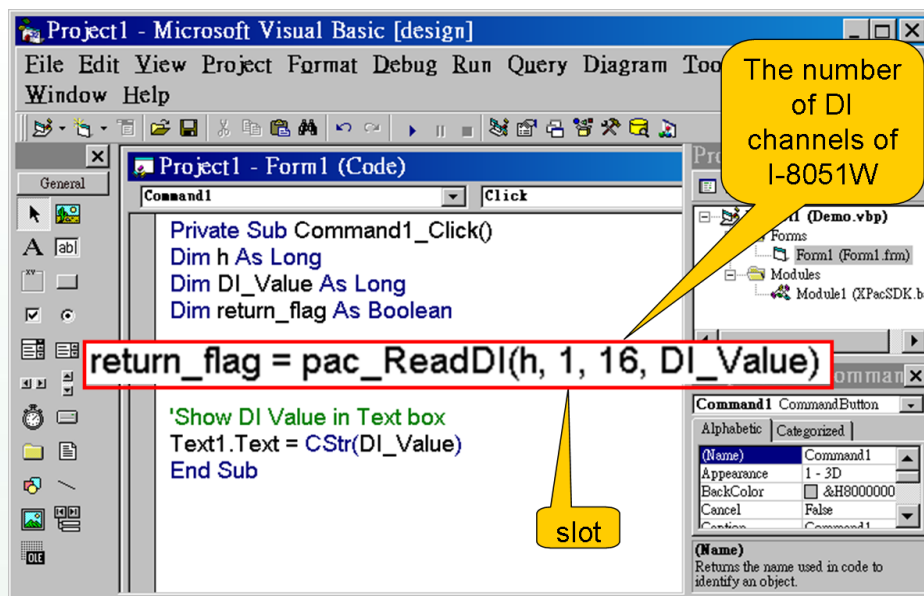

Note:

The arguments of the above example are described here:

h: handle of UART. The I-8K series I/O modules ignore this argument.

1: the slot which I-8051W plugs in.

16: the number of total DI channels. In the case of I-8051W, the number of total DI channel is 16.

DI_Value: the variable to read back the DI value.

See xPAC_Standard_API_manual.pdf for more information.

xPAC_Standard_API_manual.pdf can be found in the companion CD or the FTP site of ICP DAS.

Step 8: The snapshot of the demo program

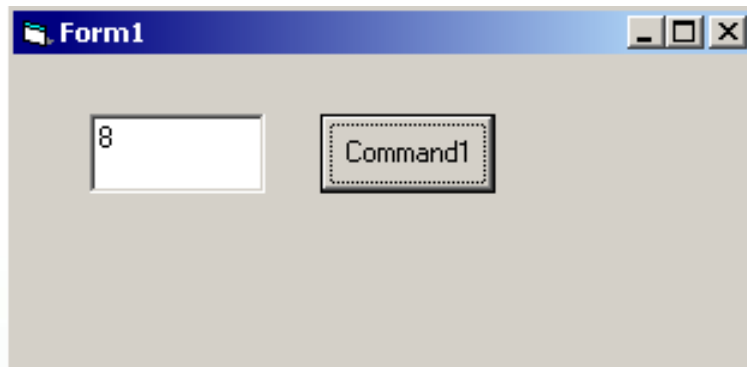

Note:

The read back DI value is the binary representation of the total 16 DI channels. If DI3 turns on, the read back DI value is “0000,0000,0000,1000” of binary representation, that is, DI is 8 as its decimal form. Users can use `pac_GetBit(DI_Value, index)` to get the DI value of a specified channel. See `xPAC_Standard_API_manual.pdf` for details.

To execute the program you build, be sure to put `XPacSDK.dll` and the program's `.exe` file in the same directory.

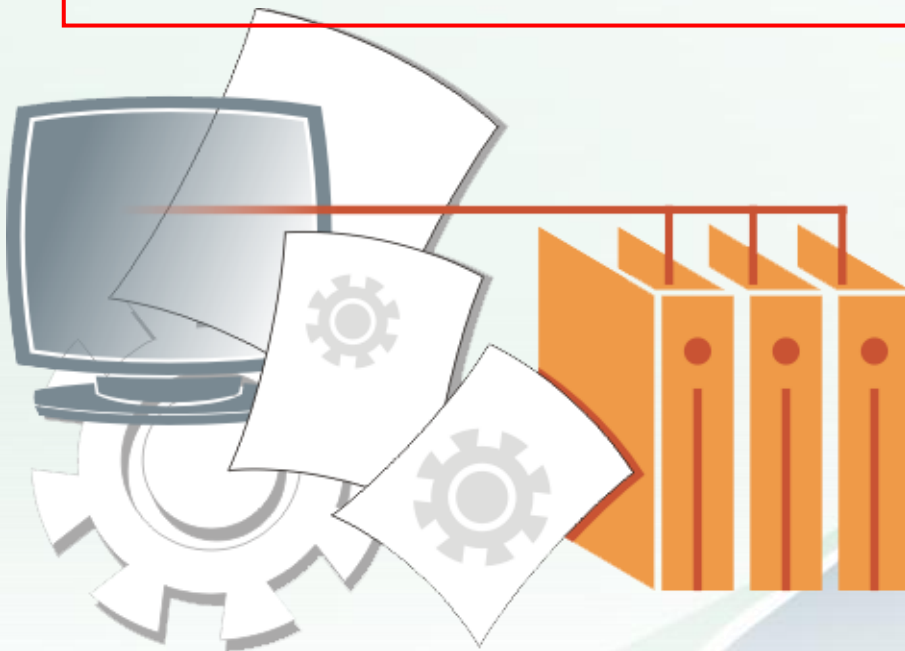



Industrial
Communication
Products

5. How to use SQL Server Express

XP-8000 default has SQL Server 2005 Express.
This chapter shows you how to use it
basically.

5.1. SQL SERVER MANAGEMENT STUDIO EXPRESS

Microsoft SQL Server Management Studio Express (SSMSE) is a free management tool for managing SQL Server 2005 Express Edition.

First of all, you should download “Microsoft SQL Server Management Studio Express” at:

<http://www.microsoft.com/downloads/details.aspx?FamilyId=C243A5AE-4BD1-4E3D-94B8-5A0F62BF7796&displaylang=en>

After downloading it, install it.



5.2. CREATE A TABLE FOR EXAMPLE

In this section, we use Microsoft SQL Server Management Studio Express (SSMSE) to create a table to store data. If you do not have SSMSE, refer to previous section to download and install it.

Follow steps below to create a table:

Step 1: run SSMSE



Step 2: connect the SQL server. (XP-8000 has SQL Server Express with default account sa and default password icpdas; Refer to 3.5 How to configure the security settings of SQL Server for more information)



Step 3: create a table

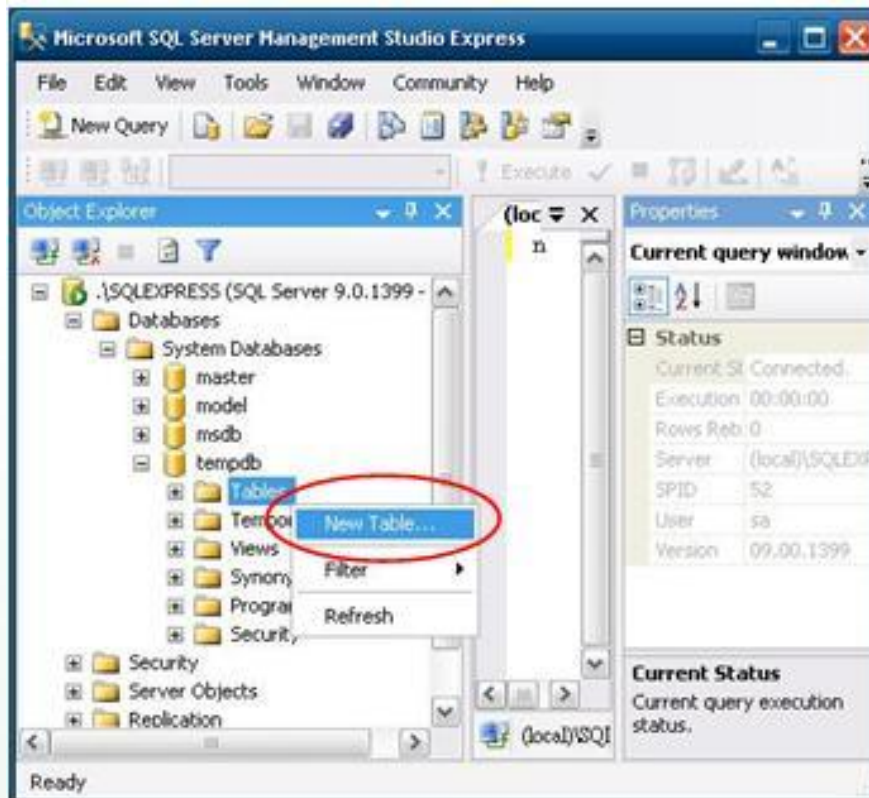

Step 4: edit column names of the table

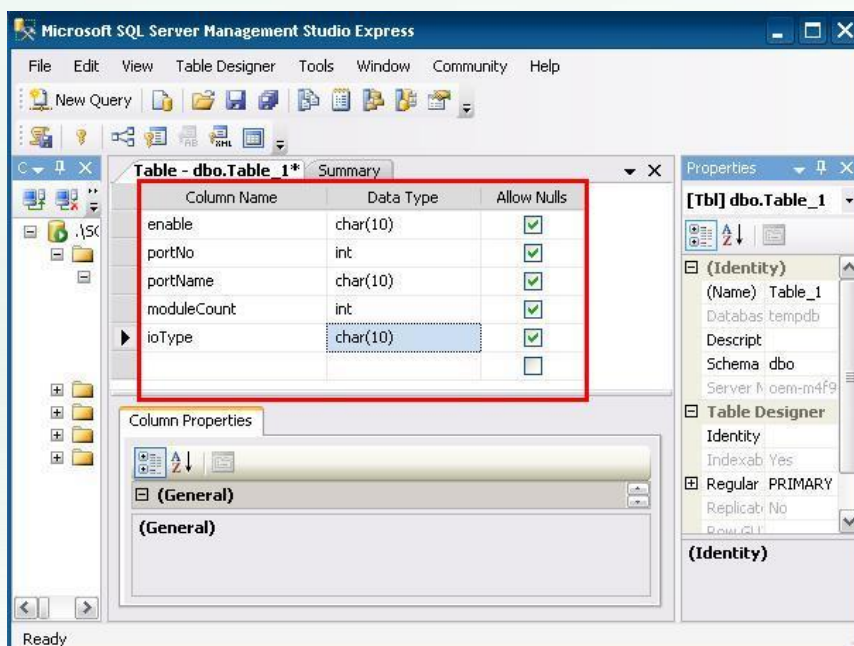

Step 5: save the table



Step 6: open the table

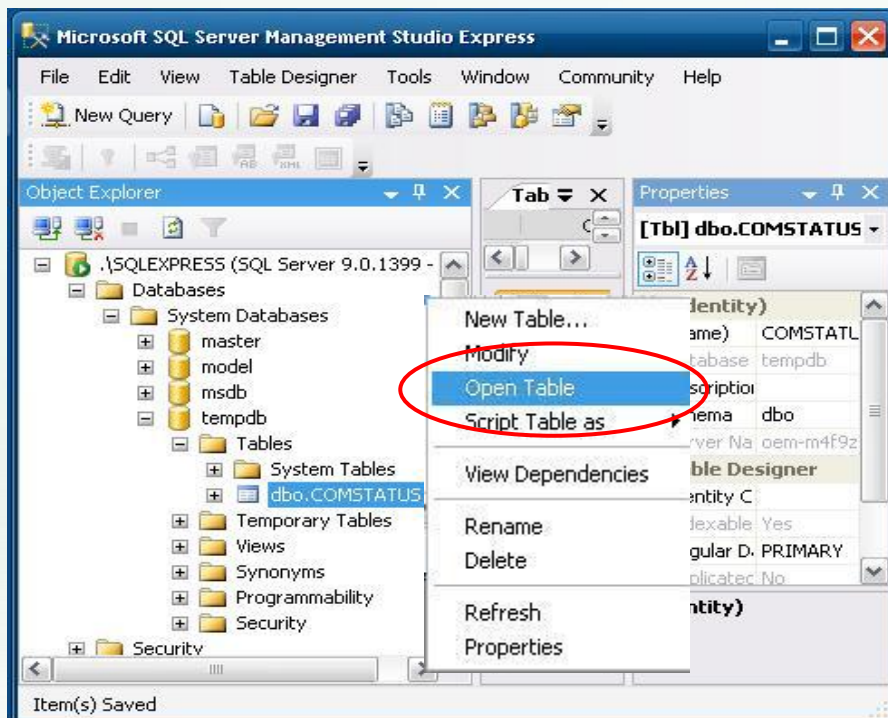



Step 7: insert data into the table

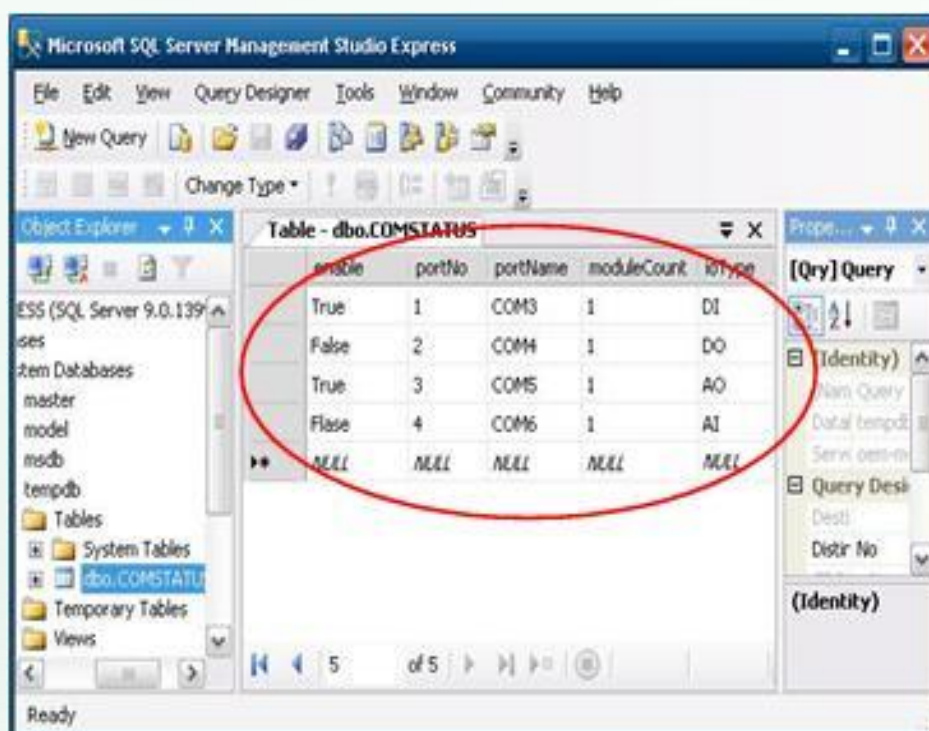

Step 8: now you have a table in the database



A

Industrial Communication Products

Appendix A. Frame Ground

Electronic circuits are constantly vulnerable to Electro-Static Discharge (ESD), which become worse in a continental climate area. Some I-7000, M-7000 and I-8000 series modules feature a new design for the frame ground, which provides a path for bypassing ESD, allowing enhanced static protection (ESD) capability and ensures that the module is more reliable.

To protect XP-8000 from ESD damage, connect the Frame Ground pins to the earth. (In section 1.5 Overview, please refer to Item 13 in "Overview Item Description" to see where the Frame Ground pins are)

The XP-8000 Series provide another better protection from ESD:
The XP-8000 controller has a metallic board attached to the back of the plastic basket as shown in below.

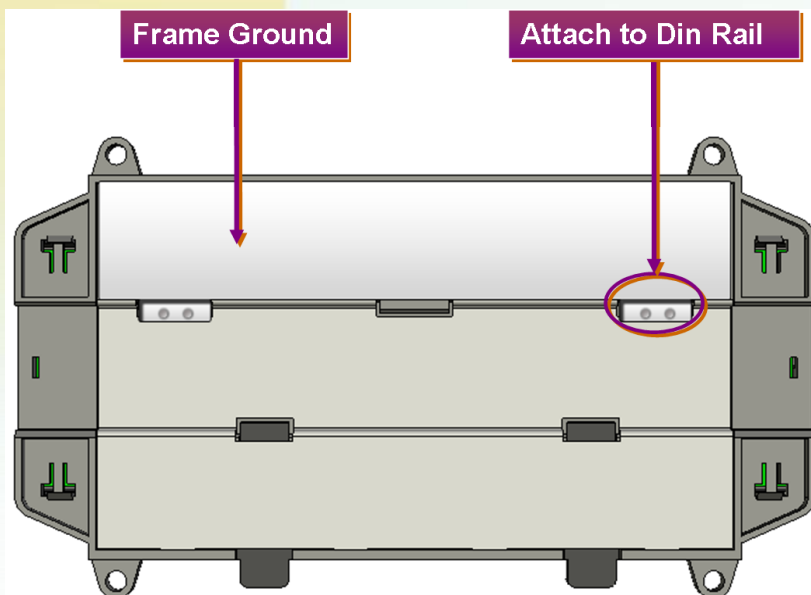

When mounted to the DIN rail, be sure to connect the DIN rail to the earth ground. Because the DIN rail is in contact with the upper Frame Ground as shown in below.

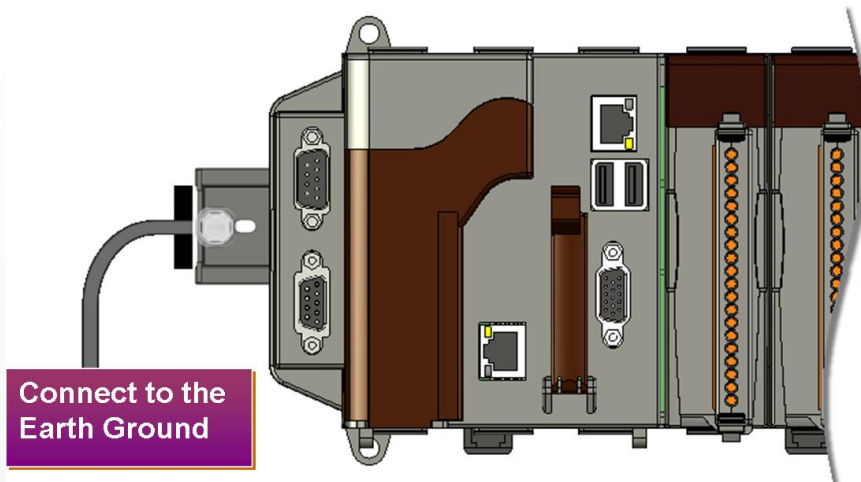



B

Industrial
Communication
Products

Appendix B. XP-8000 Tools

B.1. DCON UTILITY

The DCON Utility is a toolkit that helps users search across the network through the DCON protocol, easily configure the I/O modules

and test the I/O status via the serial ports (RS-232/RS-485) or Ethernet Ports (using virtual COM Port). It supports not only the DCON Protocol I/O modules but also the M Series I/O Modules (Modbus RTU M-7K, M-87K and will support Modbus ASCII M-87K).

For more detailed information on DCON Utility application, please refer to:

<http://www.icpdas.com/products/dcon/introduction.htm>





C

Industrial
Communication
Products

Appendix C. Application of RS-485 Network

The RS-485 length can be up to 4000 ft or 1.2 km over a single set of twisted-pair cables, if the RS-485 network is over 4000 ft or 1.2Km, the RS-485 repeater must be added to extend the RS-485 network.

C.1. BASIC RS-485 NETWORK

The basic component of the RS-485 network consist of a Master Controller (or using a PC as a host controller), and some RS-485 devices.

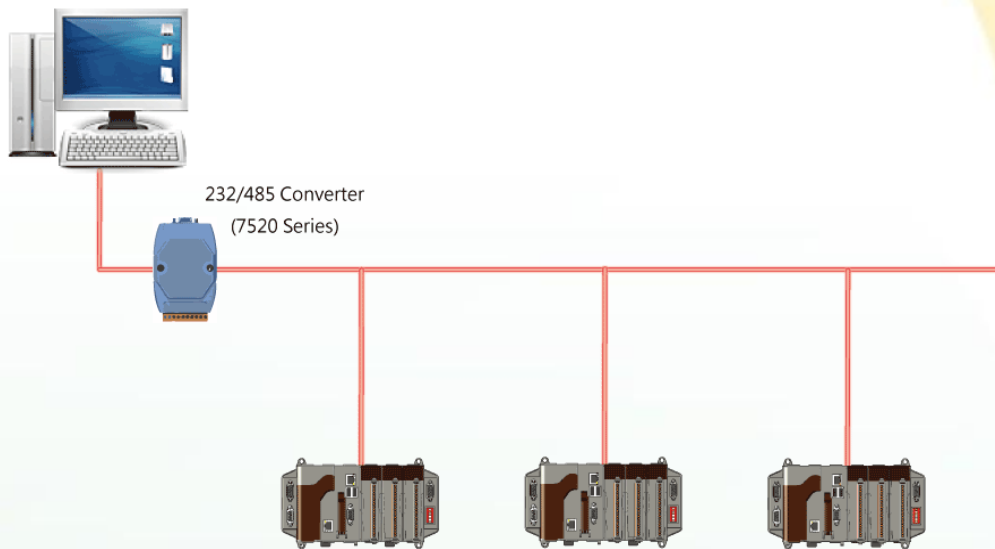

C.2. DAISY CHAIN RS-485 NETWORK

All RS-485 devices are wired directly to the main network, If the network is up to 1.2 km, it will need a repeater (7510 series) to extend the network length.

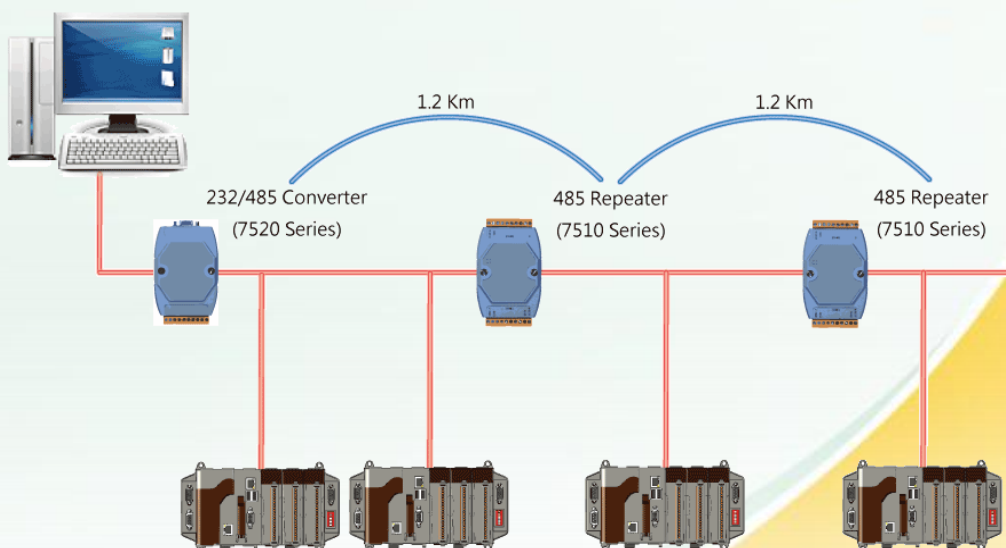

C.3. STAR TYPE RS-485 NETWORK

There are branches along the main network. In this case, it is better to have a repeater to isolate or filter the noise that is made by devices.

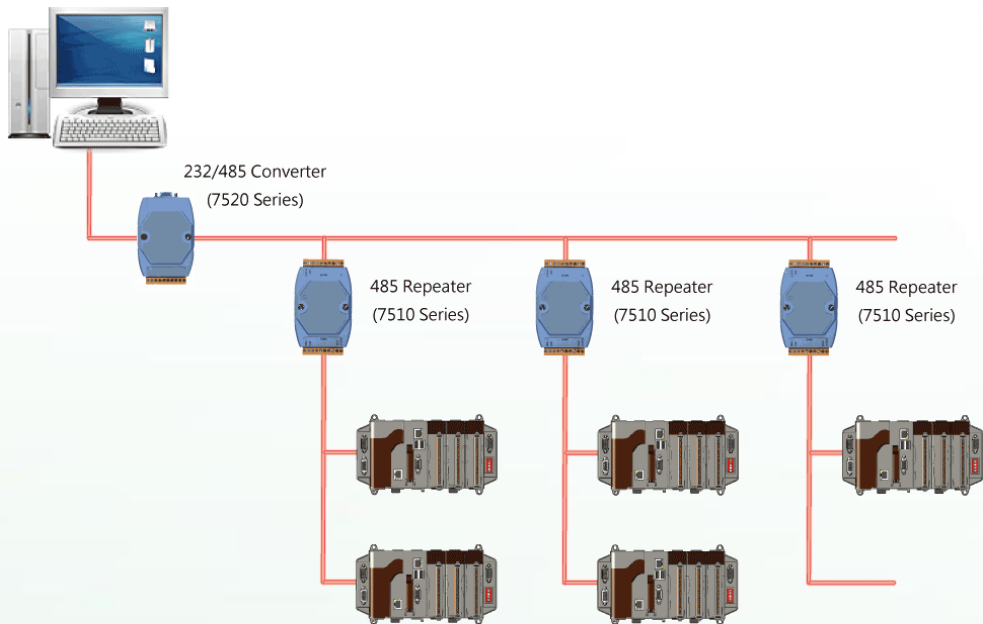

There is a better choice to use 7513 as a RS-485 hub on star type network.

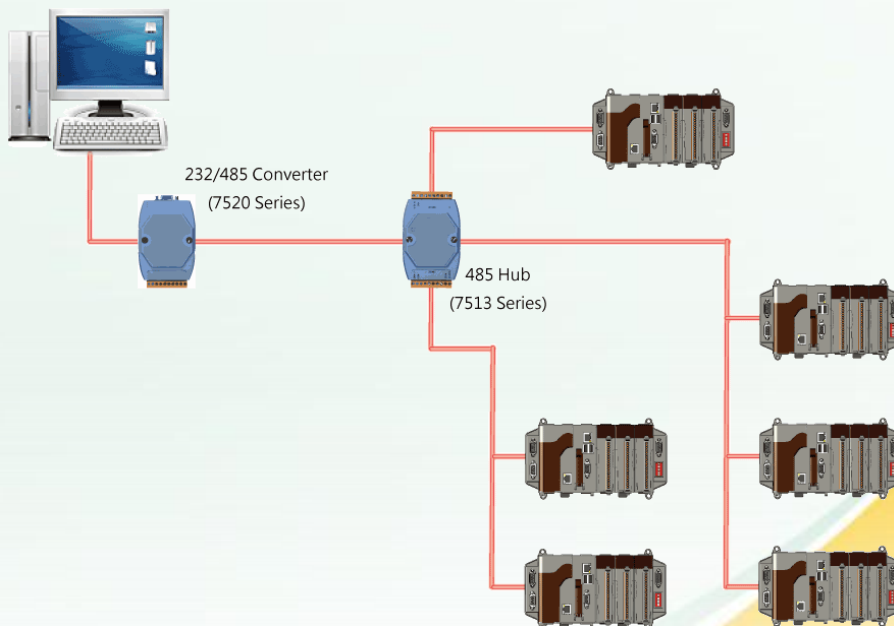

C.4. RANDOM RS-485 NETWORK

There are branches along the main wire. In this case, it is better to have a repeater to isolate or filter the noise that is made by devices.

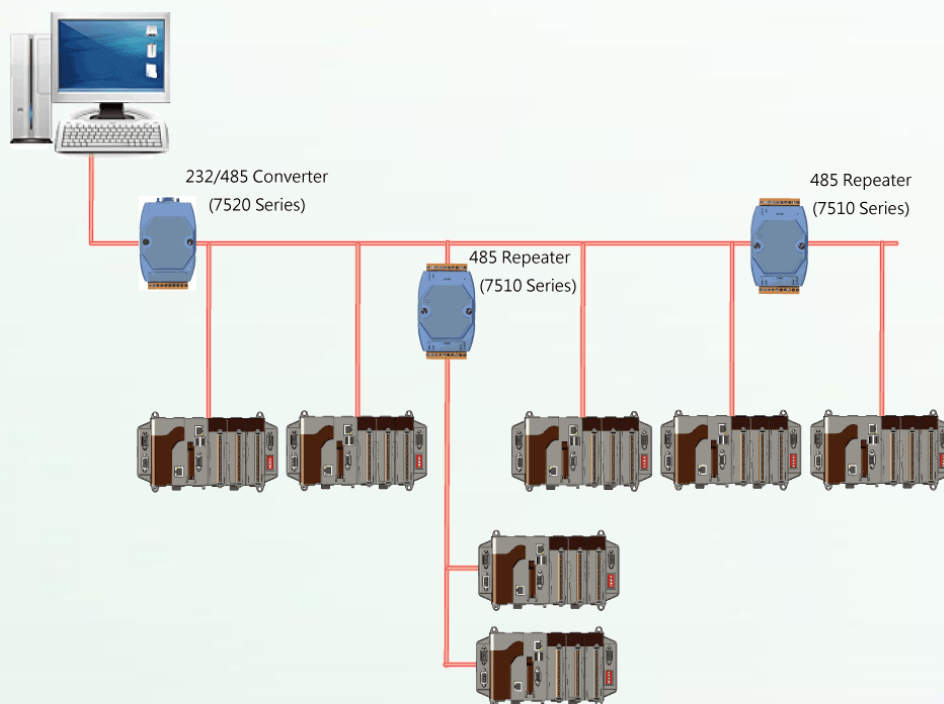

C.5. MASTER/SLAVES SETTINGS

There must exist one master to have a pull-high/pull-low resistor in the same network. In a master/slave applications, "Master" is the default configuration of XP-8000.

XP-8000 as a Slave:

For most of application, only one 7520 series module is used as RS-232/485 converter, and its pull-high/pull-low resistors are set to be enabled. Then the XP-8000 and all the other devices on this network must be in their slave mode (the pull-high/pull-low resistors must be disabled).

Please refer to the following figure to set the jumpers to the slave mode. The jumpers are located at the power board of XP-8000.



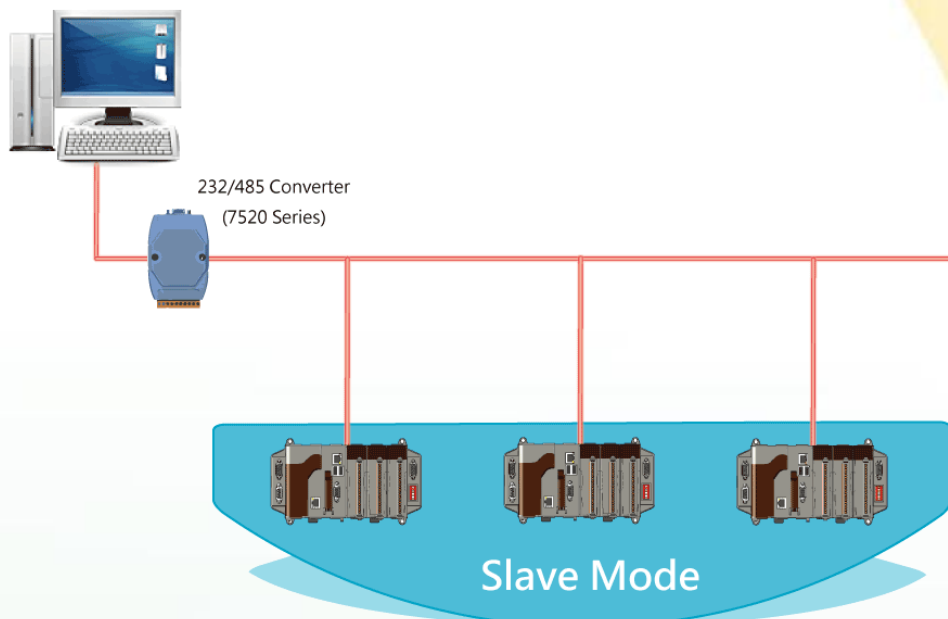

If there are repeaters on the RS-485 network, you can see that there are pull-high/pull-low resistors on both sides of the repeaters (i-7510)

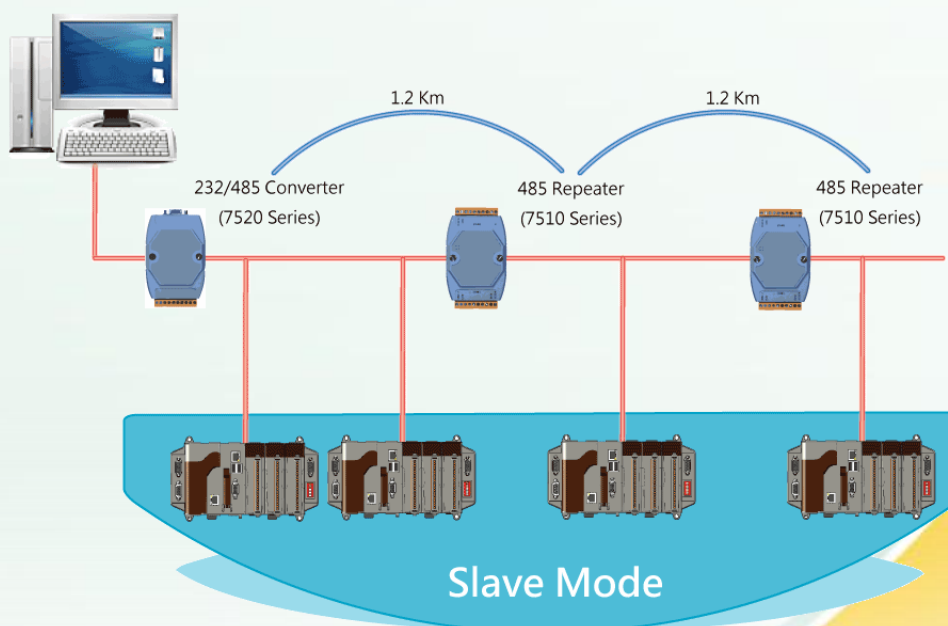



XP-8000 as a Master (default):

When one of XP-8000 is set to the master mode, then all the other devices on the same network must be set to the slave mode.

Set an XP-8000 to the master mode by adjusting the jumpers on the power board of XP-8000 (the pull-high/pull-low resistors are adjusted to be enabled.)

Refer to the following figure:

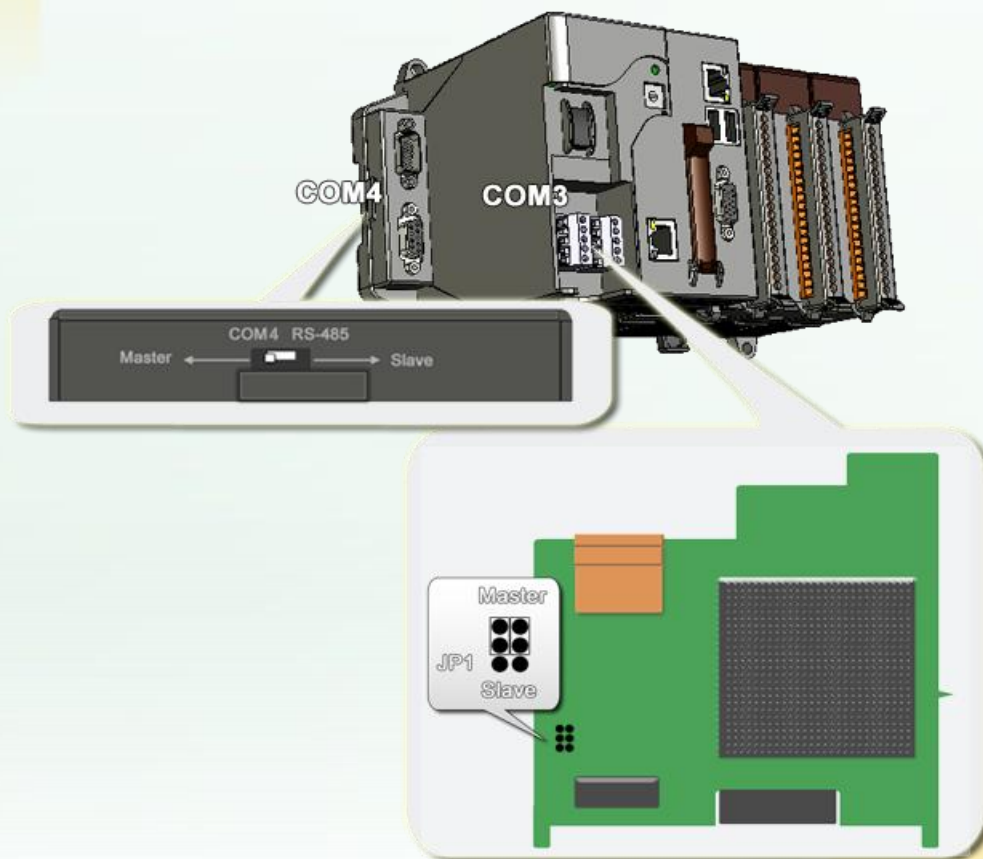



Industrial Communication Products

Appendix D. Tips – How To

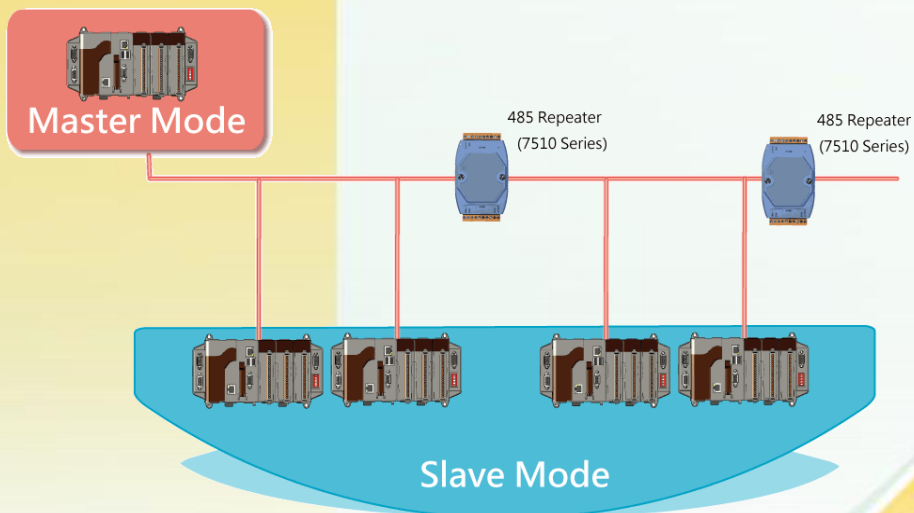

D.1. HOW TO USE ROTARY SWITCH

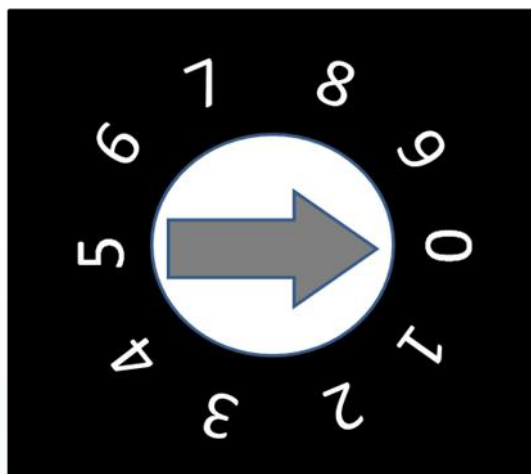

The rotary switch is reserved for application uses.

During normal operation, the position of the rotary switch has no effects on XP-8000.

We provide XPacSDK to read back the value of the rotary switch.

```
int pac_GetRotaryID();
```

The returning value of `pac_GetRotaryID()` is what the arrow points to.



D.2. HOW TO USE DIP SWITCH

The DIP switches are reserved for application uses.

During normal operation, the positions of the DIP switches have no effects on XP-8000.

We provide XPacSDK to read back the value of DIP switches.

```
int pac_GetDIPSwitch();
```

The returning value of `pac_GetDIPSwitch()` is a integer ranged from 0 to 255, which corresponds to the positions of the DIP switches.

Below is the figure of DIP switches similar to that of XP-8000.

The first DIP switch is the LSB and the 8th DIP switch is the MSB.

If the DIP switch slides up to the “ON” side, it represents 1.

If the DIP switch slides down to the number side, it represents 0.

In this way, the eight-bit DIP switches can be represented by 0 ~ 255.

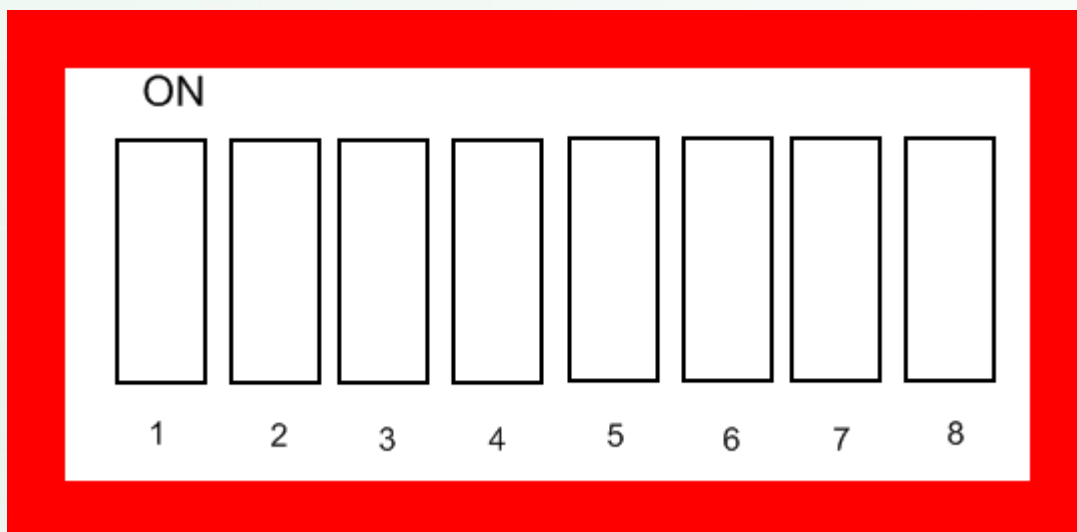

D.3. HOW TO USE MULTI-IO MODULES

The multi-IO modules, including I-8114W, I-8112W, I-8144W, and I-8142W, make your device have expansion COM ports. For using these modules, you should do some setting as following:

To Register Multi-IO Modules:

1. Disable EWF.
2. After reboot, ensure the IO module is connected and execute the Multi-Port IO module Register Wizard.
 - (1) Open Multi-Port IO Module Register Wizard,
Start - ICPDAS - Multi-Port IO Module Register Wizard

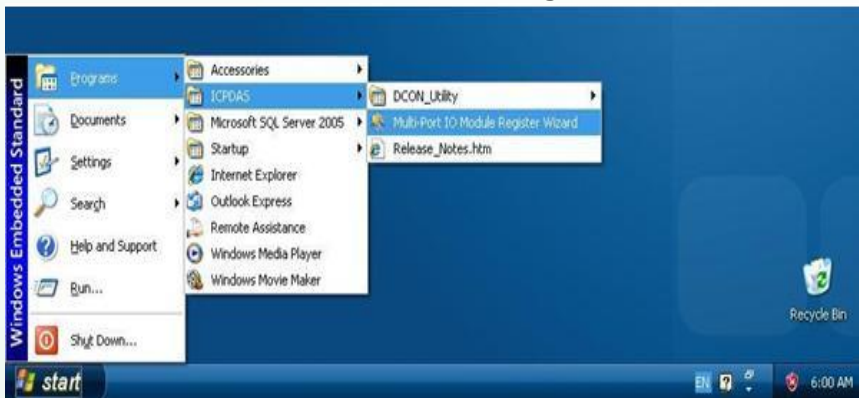

- (2) Register Multi-Port IO Module and select "Exit"

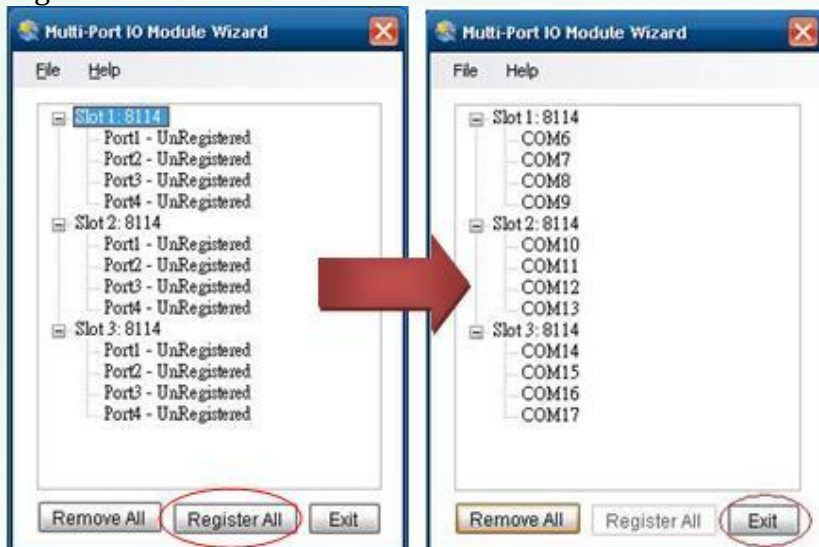

(3) Select "OK" and reboot



(4) After reboot, XP-8000 will install Multi-IO ports

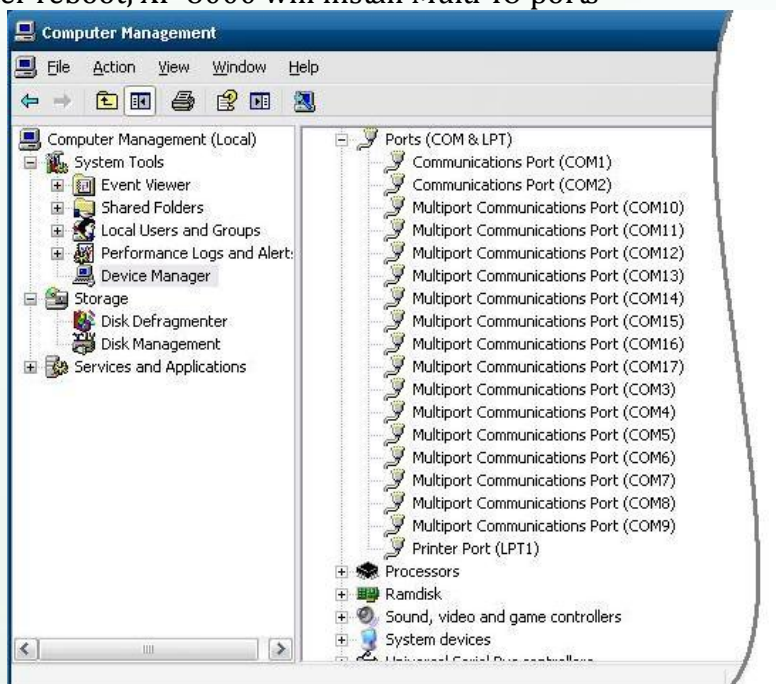

3. After finishing , please enable EWF to protect your operation system

Note: Change EWF status information, please refer to section [3.3 How to Change the Status of Enhanced Write Filter\(EWF\)](#)

To Remove Register Multi-IO Modules:

1. Disable EWF.
2. After reboot, ensure the IO module connected and execute the Multi-Port IO module Register Wizard.

- (1) Open Multi-Port IO Module Register Wizard,
Start - ICPDAS - Multi-Port IO Module Register Wizard



- (2) Remove Multi-Port IO Module and select "Exit"

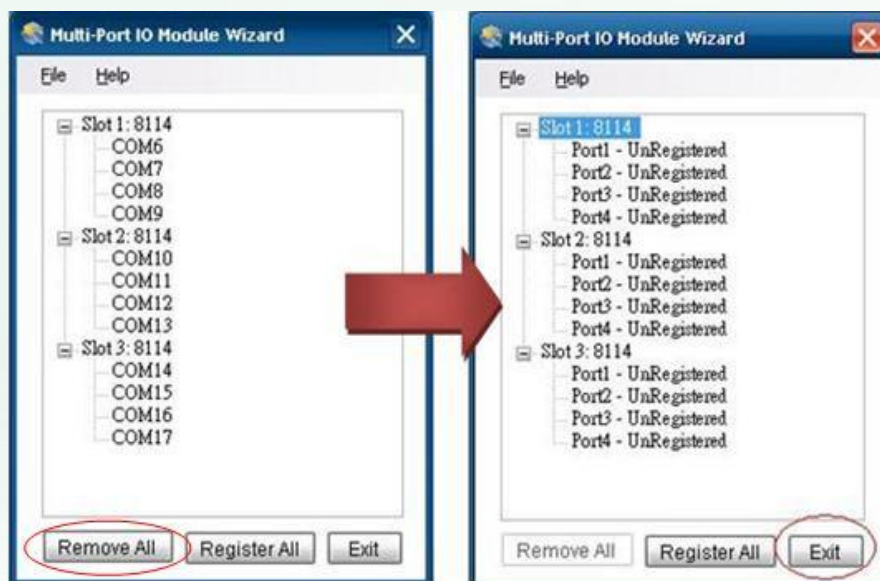

(3) Select "OK" and reboot



(4) After reboot, XP-8000 will remove Multi-IO ports

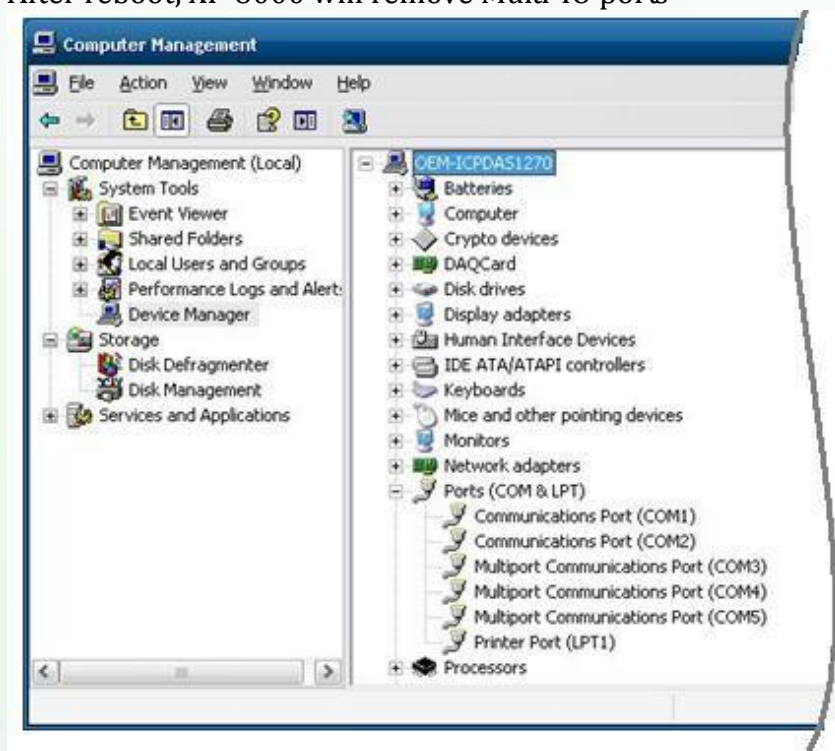

3. After finishing , please enable EWF to protect your operation system

Note: Change EWF status information, please refer to section [3.3 How to Change the Status of Enhanced Write Filter \(EWF\)](#)