



PIO-D96 Series Card

User Manual

96-channel DIO board

Version 2.2, Jul. 2015

SUPPORTS

Board includes PIO-D96, PIO-D96U, PIO-D96SU and PEX-D96S.

WARRANTY

All products manufactured by ICP DAS are warranted against defective materials for a period of one year from the date of delivery to the original purchaser.

WARNING

ICP DAS assumes no liability for damages consequent to the use of this product. ICP DAS reserves the right to change this manual at any time without notice. The information furnished by ICP DAS is believed to be accurate and reliable. However, no responsibility is assumed by ICP DAS for its use, nor for any infringements of patents or other rights of third parties resulting from its use.

COPYRIGHT

Copyright © 2014 by ICP DAS. All rights are reserved.

TRADEMARK

Names are used for identification only and may be registered trademarks of their respective companies.

CONTACT US

If you have any question, please feel to contact us. We will give you quick response within 2 workdays.

Email: service@icpdas.com, service.icpdas@gmail.com

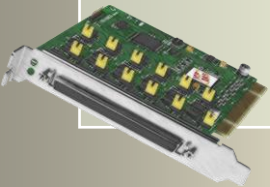
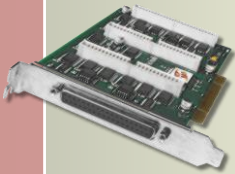

TABLE OF CONTENTS

1.	INTRODUCTION	3
1.1	PACKING LIST.....	4
1.2	FEATURES	4
1.3	SPECIFICATIONS	5
2.	HARDWARE CONFIGURATION.....	6
2.1	BOARD LAYOUT	6
2.2	I/O PORT LOCATION	8
2.3	CARD ID SWITCH	9
2.4	PIN ASSIGNMENTS.....	10
2.4.1	<i>PIO-D96 and PIO-D96U</i>	<i>10</i>
2.4.2	<i>PIO-D96SU and PEX-D96S</i>	<i>11</i>
2.5	ENABLE I/O OPERATION.....	12
2.6	DI/O ARCHITECTURE	13
2.7	INTERRUPT OPERATION	14
3.	HARDWARE INSTALLATION	15
4.	SOFTWARE INSTALLATION	19
4.1	OBTAINING/INSTALLING THE DRIVER INSTALLER PACKAGE	19
4.2	PNP DRIVER INSTALLATION	20
4.3	VERIFYING THE INSTALLATION	21
4.3.1	<i>How do I get into Windows Device Manager?</i>	<i>21</i>
4.3.2	<i>Check that the Installation</i>	<i>23</i>
5.	TESTING PIO-D96 SERIES CARD	24
5.1	SELF-TEST WIRING	24
5.1.1	<i>PIO-D96 and PIO-D96U</i>	<i>24</i>
5.1.2	<i>PIO-D96SU and PEX-D96S</i>	<i>25</i>
5.2	EXECUTE THE TEST PROGRAM.....	26
6.	I/O CONTROL REGISTER	28
6.1	HOW TO FIND THE I/O ADDRESS.....	28
6.1.1	<i>PIO_PISO Utility.....</i>	<i>29</i>
6.2	THE ASSIGNMENT OF I/O ADDRESS	32
6.3	THE I/O ADDRESS MAP	34

6.3.1	RESET\ Control Register.....	35
6.3.2	AUX Control Register	35
6.3.3	Aux Data Register	36
6.3.4	INT Mask Control Register.....	36
6.3.5	Aux Status Register.....	37
6.3.6	Interrupt Polarity Register	37
6.3.7	I/O Selection Control Register.....	38
6.3.8	Card ID Register	39
6.3.9	Read/Write 8-bit Data Register	39
7.	DEMO PROGRAMS.....	40
7.1	DEMO PROGRAM FOR WINDOWS	40
7.2	DEMO PROGRAM FOR DOS	42
	APPENDIX: DAUGHTER BOARD	43
A1.	DB-37, DN-37, DN-50 and DN-100	43
A2.	DB-8125.....	44
A3.	ADP-37/PCI and ADP-50/PCI	44
A4.	DB-24P and DB-24PD Isolated Input Board.....	45
A5.	DB-24R and DB-24RD Relay Board.....	46
A6.	DB-24PR, DB-24POR and DB-24C.....	47
A7.	Daughter Boards Comparison Table.....	48

1. Introduction

The PEX-D96S and PIO-D96U/D96SU cards are the new generation product that ICP DAS provides to meet RoHS compliance requirement, and is designed as an easy replacement for the PIO-D96, without requiring any modification to the software or the driver.

The PIO-D96U/D96SU universal PCI card supports 3.3 V/5 V PCI bus while the PEX-D96S supports PCI Express bus. These cards provide 96 TTL Digital I/O lines that consist of twelve 8-bit bi-directional ports. Each group of three 8-bit ports is arranged on the connector as Port A (PA), Port B (PB) and Port C (PC), respectively, and all ports are configured as inputs ports on power-up or after a reset.

The PIO-D96U provides four connectors for I/O wiring, while the PIO-D96SU and PEX-D96S provides a single high-density connector that reduces the amount of installation space required for the card in the computer.

The PIO-D96U/D96SU and PEX-D96S cards include an onboard Card ID switch that enables the board to be recognized via software if two or more boards are installed in the same computer. The pull-high/low jumpers allow the DI status to be predefined instead of remaining floating if the DI channels are disconnected or interrupted.

These cards support various OS such as Linux, DOS, Windows 98, Windows NT, Windows 2000, 32-/64-bit Windows XP/2003/2008/Vista/7 and Windows 8. It also provides the DLL and Active X control, and various language sample programs in Turbo C++, Borland c++, Microsoft C++, Visual C++, Borland Delphi, Borland C++ Builder, Visual Basic, C#.NET, Visual Basic.NET and LabVIEW to help users to quickly and easily develop their applications.

Comparison Table

Model	Interface	DI Pull-High/Low	Card ID	Compatibility	Advantage
PEX-D96S	PCI Express	Yes	Yes	5 V/CMOS	Low power consumption Low temperature
PIO-D96SU	Universal PCI	Yes	Yes	5 V/CMOS	Low power consumption Low temperature
PIO-D96U	Universal PCI	Yes	Yes	5 V/TTL	High DO Driving (Output Capability)
PIO-D96	PCI Bus	No	No	5 V/TTL	High DO Driving (Output Capability)

1.1 Packing List

The shipping package includes the following items:

- One PIO-D96 series card hardware, as follows:

PIO-D96



PIO-D96SU



PIO-D96U



PEX-D96S



- One printed Quick Start Guide



- One software utility CD



Note:

If any of these items is missing or damaged, contact the dealer from whom you purchased the product. Save the shipping materials and carton in case you want to ship or store the product in the future.

1.2 Features

- Support the +5V PCI bus for PIO-D96
- Support the +3.3/+5 V PCI bus for PIO-D96U/D96SU
- Support the PCI Express x 1 for PEX-D96S
- 96 channels of digital I/O
- Bi-direction programmable I/O ports under software control
- All I/O lines buffered on the board
- Twelve 8-bit bi-direction I/O ports
- 4 Interrupt source: P2C0, P5C0, P8C0, P11C0
- Card ID function for PIO-D96U/D96SU and PEX-D96S
- Pull-high/low jumpers for DI channels for PIO-D96U/D96SU and PEX-D96S
- PIO-D96/D96U: one DB37 connector and three 50-pin box headers
- PIO-D96SU/PEX-D96S: one SCSI II 100-pin connector
- Buffer output for higher driving capability
- Connects directly to DB-24PR, DB-24PD, DB-24RD, DB-24PRD, DB-16P8R, DB-24POR, DB-24SSR, DB-24C or any OPTO-22 Compatible daughter boards
- PIO-D96/D96U/D96SU: DIO response time is about 1 μ s (1MHz)
- PEX-D96S: DIO response time is about 500 kHz
- SMD, short card, power saving

1.3 Specifications

Model Name	PEX-D96S	PIO-D96SU	PIO-D96U	PIO-D96
Programmable Digital I/O				
Channels	96			
Digital Input				
Compatibility	5 V/COMS		5 V/TTL	
Input Voltage	Logic 0: 0.8 V max. Logic 1: 2.0 V min.			
Response Speed	500 kHz	1 MHz		
Digital Output				
Compatibility	5 V/COMS		5 V/TTL	
Output Voltage	Logic 0: 0.1 V max. Logic 1: 4.4 V min.		Logic 0: 0.4 V max. Logic 1: 2.4 V min.	
Output Capability	Sink: 6 mA @ 0.33 V Source: 6 mA @ 4.77 V		Sink: 64mA @ 0.8 V Source: 32 mA @ 2.0 V	
Response Speed	500 kHz	1 MHz		
General				
Bus Type	PCI Express x 1	3.3 V/5 V Universal PCI, 32-bit, 33 MHz	5 V PCI, 32-bit, 33 MHz	
Data Bus	8-bit			
Card ID	Yes(4-bit)			No
I/O Connector	Female SCSI II 100 pin x 1		Female DB37 x 1 50-pin box header x 3	
Dimensions (L x W x D)	124 mm x 97 mm x 22 mm		180 mm x 105 mm x 22mm	
Power Consumption	600 mA @ +5 V			
Operating Temperature	0 ~ 60 °C			
Storage Temperature	-20 ~ 70 °C			
Humidity	5 ~ 85% RH, non-condensing			

2. Hardware Configuration

2.1 Board Layout

PIO-D96:

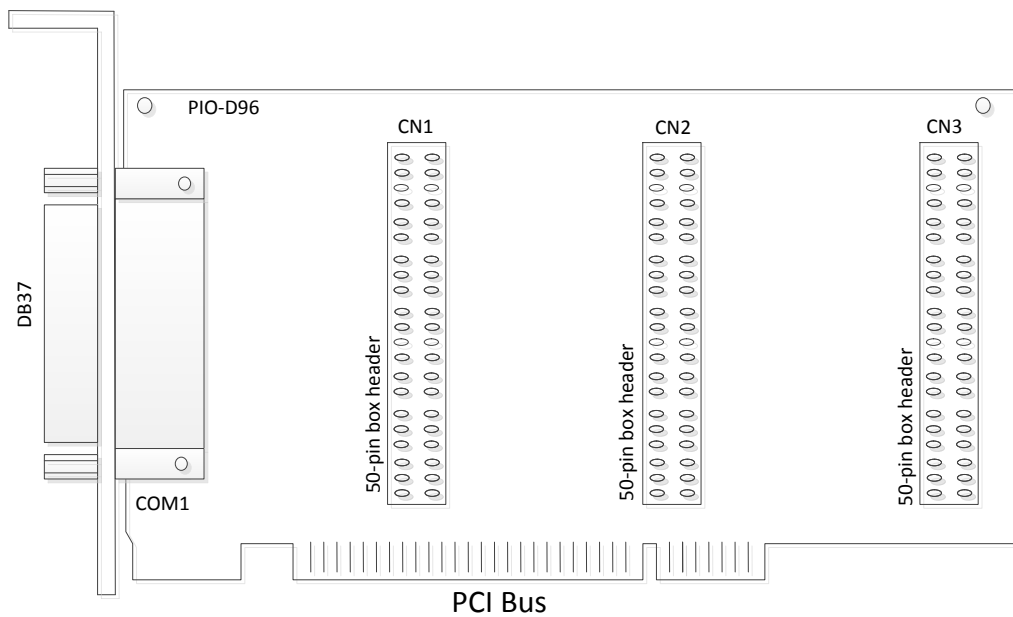

PIO-D96U:

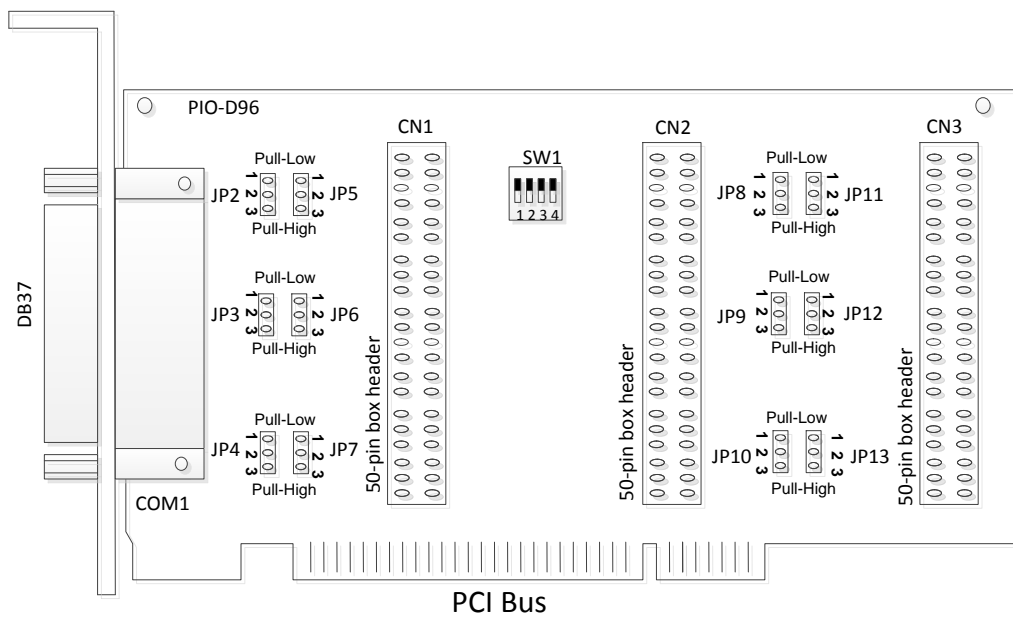

Note:

JPx Default Setting:

Legend for jumper pin settings:

- Pull-Low
- ∞ Pull-High

JP2/3/4/5/6/7
/9/10/11/12/13=
1-2 short = Pull-Low

■ **PIO-D96SU:**

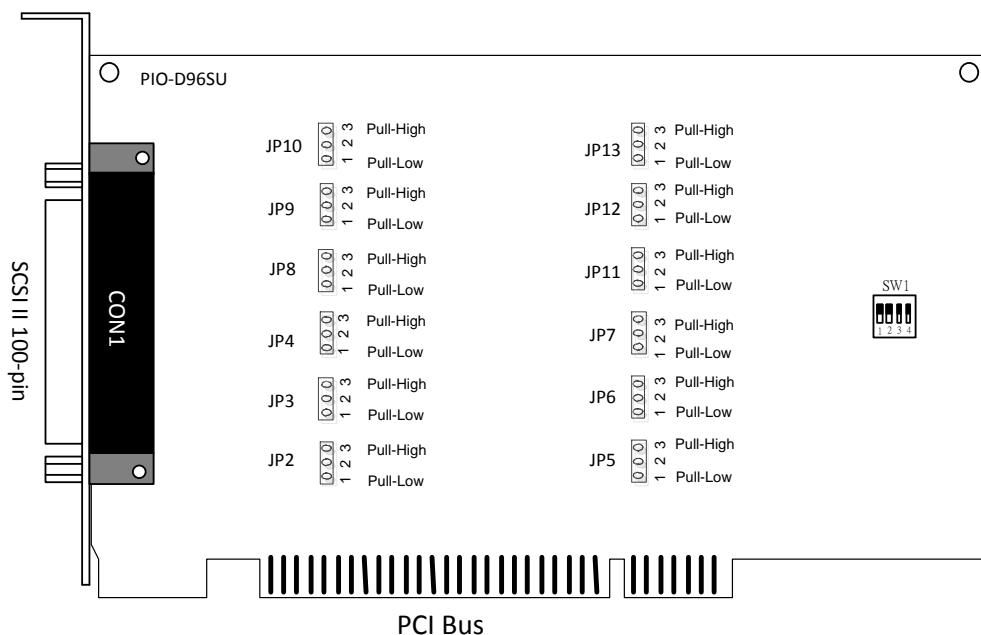

Note:

JPx Default Setting:

3 Pull-High
 2
 1 Pull-Low

JP2/3/4/5/6/7
/9/10/11/12/13=
1-2 short = Pull-Low

■ **PEX-D96S:**

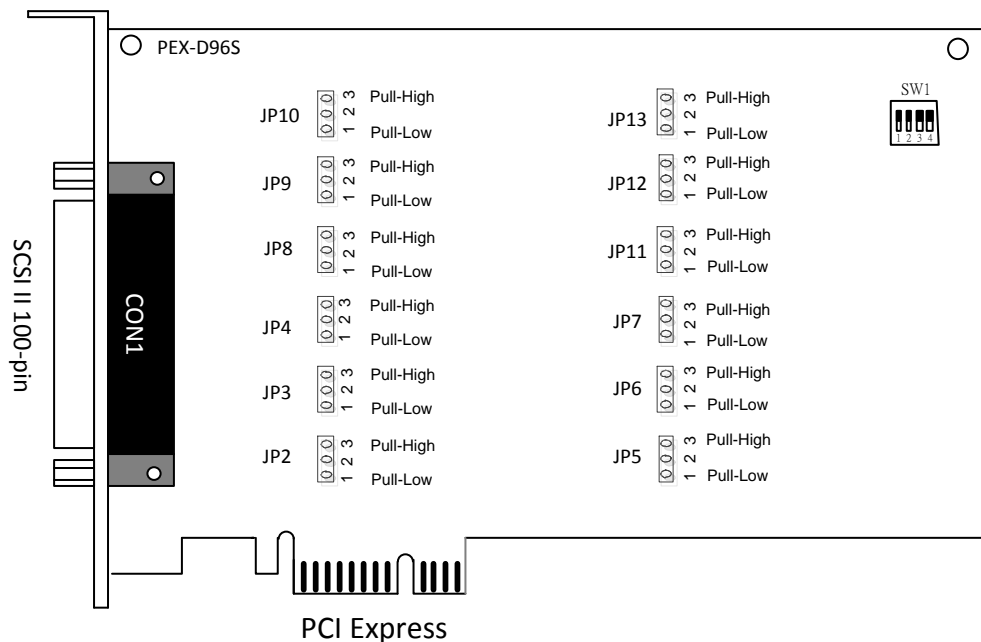

Note:

JPx Default Setting:

3 Pull-High
 2
 1 Pull-Low

JP2/3/4/5/6/7
/9/10/11/12/13=
1-2 short = Pull-Low

2.2 I/O Port Location

There are twelve 8-bit I/O ports in the PIO-D96 series card. Each I/O port can be programmed as a DI or DO port. When the PC is first powered-on or reset all the ports are configured as DI ports. These DI ports can be selected to either pull-high or pull-low via placement of the JP2 to JP13 jumpers. These I/O port locations are given as follows:

Connector of <u>PIO-D96/D96U</u>		CON1	CN1	CN2	CN3
PA0 ~ PA7	Port	Port0	Port3	Port6	Port9
	Pull-high/Low	JP2	JP5	JP8	JP11
PB0 ~ PB7	Port	Port1	Port4	Port7	Port10
	Pull-high/Low	JP3	JP6	JP9	JP12
PC0 ~ PC7	Port	Port2	Port5	Port8	Port11
	Pull-high/Low	JP4	JP7	JP10	JP13

Connector of <u>PIO-D96SU/PEX-D96S</u>	CON1
PA0~ PA7	Port0 (pull-high/low by JP2)
PB0 ~ PB7	Port1 (pull-high/low by JP3)
PC0 ~ PC7	Port2 (pull-high/low by JP4)
PA10~PA17	Port3 (pull-high/low by JP5)
PB10~PB17	Port4 (pull-high/low by JP6)
PC10~PC17	Port5 (pull-high/low by JP7)
PA20~PA27	Port6 (pull-high/low by JP8)
PB20~PB27	Port7 (pull-high/low by JP9)
PC20~PC27	Port8 (pull-high/low by JP10)
PA30~PA37	Port9 (pull-high/low by JP11)
PB30~PB37	Port10 (pull-high/low by JP12)
PC30~PC37	Port11 (pull-high/low by JP13)



Refer to [Sec. 2.1](#) for the board layout and I/O port locations.

Note: Each PC0 can be used as an interrupt signal source. Refer to [Sec. 2.7](#) for more information.

2.3 Card ID Switch

The PIO-D96U/D96SU and PEX-D96S has a Card ID switch (SW1) with which users can recognize the board by the ID via software when using two or more PIO-D96U/D96SU and PEX-D96S cards in one computer. The default Card ID is 0x0. For detail SW1 Card ID settings, please refer to Table 2.1.

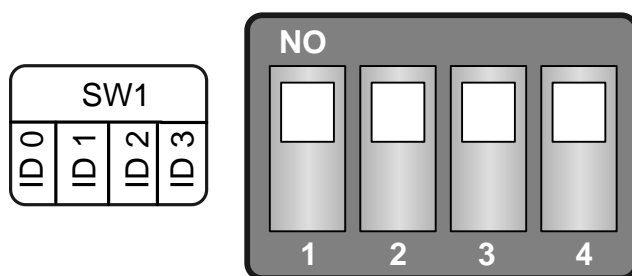

(Default Settings)

Table 2.1 (*) Default Settings; OFF → 1; ON → 0

Card ID (Hex)	1 ID0	2 ID1	3 ID2	4 ID3
(*) 0x0	ON	ON	ON	ON
0x1	OFF	ON	ON	ON
0x2	ON	OFF	ON	ON
0x3	OFF	OFF	ON	ON
0x4	ON	ON	OFF	ON
0x5	OFF	ON	OFF	ON
0x6	ON	OFF	OFF	ON
0x7	OFF	OFF	OFF	ON
0x8	ON	ON	ON	OFF
0x9	OFF	ON	ON	OFF
0xA	ON	OFF	ON	OFF
0xB	OFF	OFF	ON	OFF
0xC	ON	ON	OFF	OFF
0xD	OFF	ON	OFF	OFF
0xE	ON	OFF	OFF	OFF
0xF	OFF	OFF	OFF	OFF

2.4 Pin Assignments

2.4.1 PIO-D96 and PIO-D96U

- **CON1:** 37-pin D-type female connector (for Port0, Port1, Port2).
- **CN1/CN2/CN3:** 50-pin flat-cable connector (for Port3 ~ Port11).

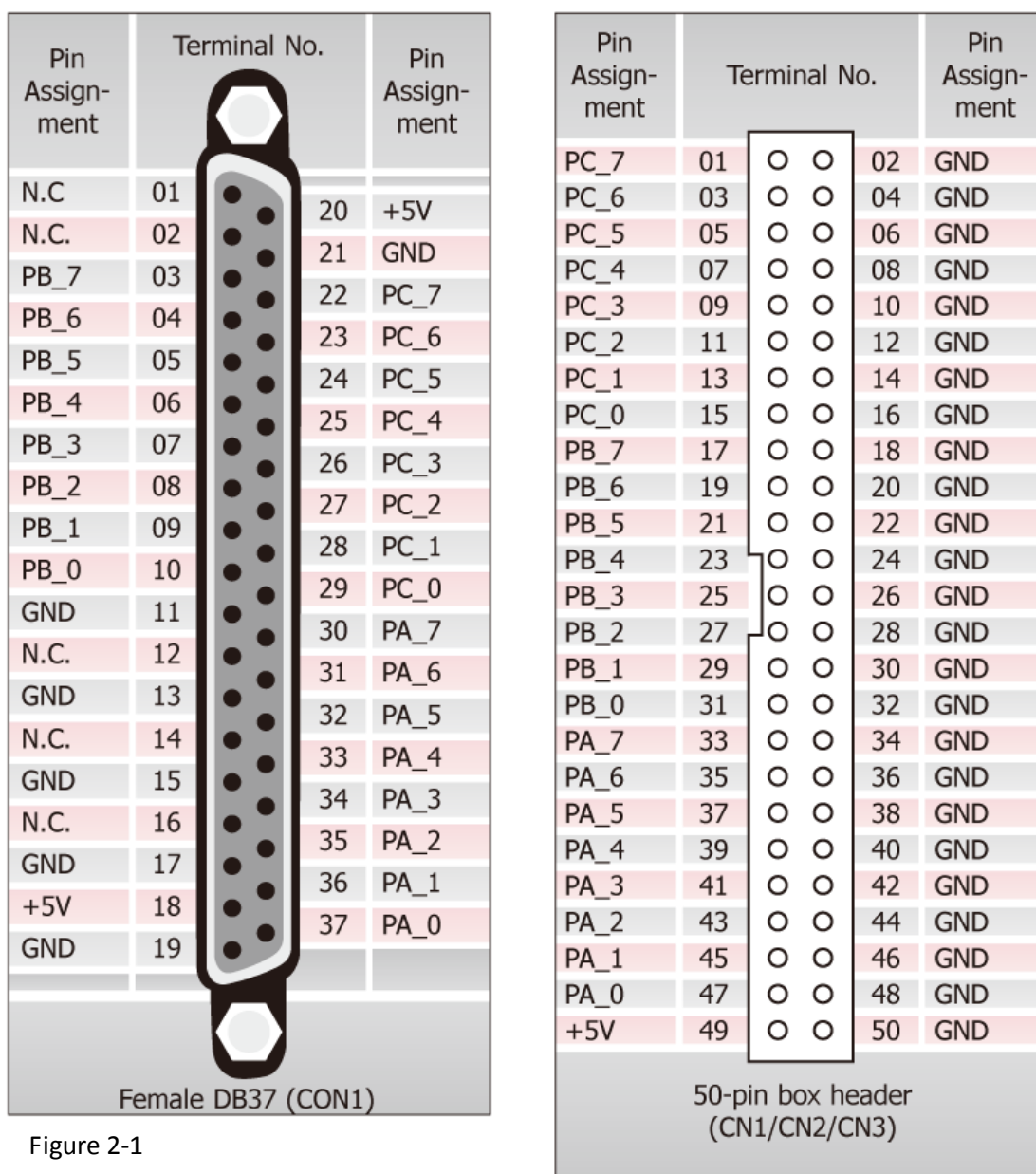

Figure 2-1

2.5 Enable I/O Operation

When the PC is first turned on, all operations involved with digital I/O channels are disabled. Note that the digital I/O channel of each port is enabled or disabled by the RESET\ signal, refer to [Sec. 6.3.1](#) for more information related to this. The power-on states for all DI/O ports are given as follows:

- D/I/O operations for each port are disabled.
- D/I/O ports are all configured as Digital input ports.
- D/O latch register outputs are all high impedance. (Refer to [Sec. 2.6](#))

The user has to perform some initialization before using these digital I/O ports. The recommended steps are given below:

Step 1: Find the address-mapping for PIO/PISO cards. (Refer to [Sec.6.1](#))

Step 2: Enable all Digital I/O operations. (Refer to [Sec. 6.3.1](#)).

Step 3: Configure the first three ports to their expected D/I/O state & send their initial values to every D/O port (Refer to [Sec. 6.3.7](#))

Step 4: Configure the other three ports to their expected D/I/O states & send their initial values to every D/O port (Refer to [Sec. 6.3.7](#))



For more information on the initial procedure for digital I/O ports, please refer to the DIO demo program.

2.6 DI/O Architecture

The digital I/O control architecture for the PIO-D96 series card is demonstrated in . The operation method used for the control signal is presented below.

- RESET\ is in the Low-state → all DI/O operation is disabled
- RESET\ is in the High-state → all DI/O operation is enabled.
- If DI/O is configured as a DI port → DI= external input signal
- If DI/O is configured as a DO port → DI = read back DO

If the DI/O is configured as a DI port → sending data to a Digital input port will only change the DO latch register. The latched data will be output when the port is configured as digital output and is activated right away.

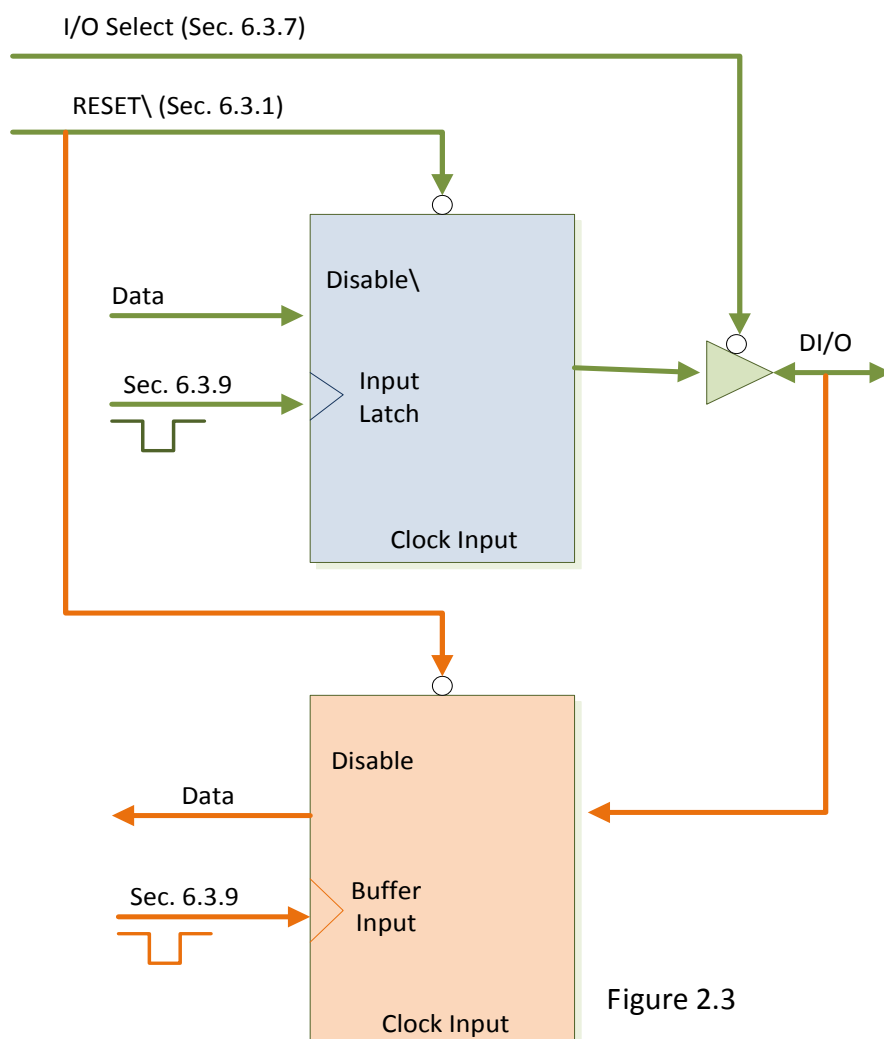

Figure 2.3

2.7 Interrupt Operation

The P2C0, P5C0, P8C0 and P11C0 can be used as interrupt signal source. Refer to [Sec. 2.1](#) and [Sec. 2.4](#) for P2C0/P5C0/P8C0/P11C0 location. The interrupt of PIO-D96 series card is **level-trigger and Active_High**. The interrupt signal can be programmable as **inverted or non-inverted**. The procedures for how to configure the interrupt signal source are given as follows:

1. Make sure **the initial level is high or Low from the signal source**.
2. If the initial state is High, please select the **inverted** setting for interrupt signal source ([Sec. 6.3.6](#)). If the initial state is Low, please select the **non-inverted** setting for interrupt signal source ([Sec. 6.3.6](#))
3. Enable the interrupt function ([Sec. 6.3.4](#))
4. If the interrupt signal is active, the interrupt service routine will be started up.

Note that DEMO3.C and DEMO4.C are demo programs for a single interrupt source and DEMO5.C is the demo program for four interrupt sources in the DOS operating system. If only one interrupt signal source is used, the interrupt service routine does not need to identify the interrupt source. (Refer to DEMO3.C and DEMO4.C). However, if there are more than one interrupt source, the interrupt service routine has to identify the active signals in the following manner: (refer to DEMO5.C)

1. Read the new status of the interrupt signal sources.
2. Compare the new status with the old status to identify the active signals.
3. If P2C0 is active, service P2C0 and non-inverter/inverted the P2C0 signal.
4. If P5C0 is active, service P5C0 and non-inverted/inverted the P5C0 signal.
5. If P8C0 is active, service P8C0 and non-inverted/inverted the P8C0 signal.
6. If P11C0 is active, service P11C0 and non-inverted/inverted the P11C0 signal.
7. Update the interrupt status.



Limitation:

If the interrupt signal is too short, the new status may be the same as the old status. So the interrupt signal must be held active until the interrupt service routine has been executed. This hold time is different for differing operating systems. The hold time can be as short as a micro-second or as long as 1 second. In general, 20 ms is enough for all O.S.

3. Hardware Installation



Note:

As certain operating systems, such as Windows 2000/XP may require the computer to be restarted after a new driver is installed, it is recommended that the driver is installed first, which will reduce the installation time.

Follow the process described below to install your PIO-D96 series card:

Step 1: Install the PIO-D96 series card driver on your computer.



For detailed information about the driver installation, please refer to [Chapter 4 Software Installation](#).

Step 2: Configuring the Card ID by the SW1 DIP-Switch.



For detailed information about the card ID (SW1), please refer to [Sec. 2.3 Car ID Switch](#).

Note that Card ID function is only supported by the PIO-D96U/D96SU and PEX-D96S.



Step 3: Correctly shut down and power off your computer, and then disconnect the power supply.

Step 4: Remove the cover from the computer.

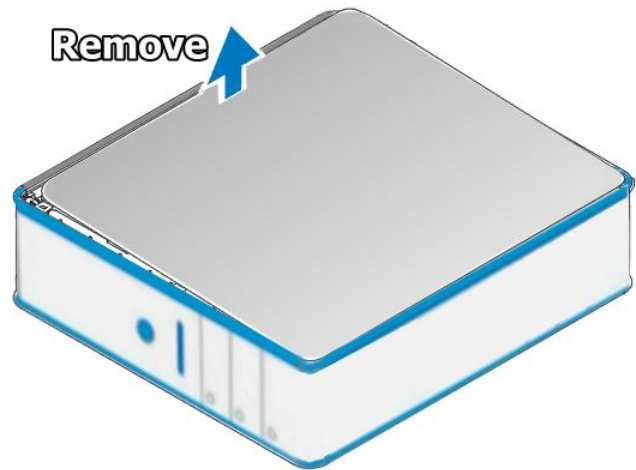

Step 5: Select an empty PCI/PCI Express slot.

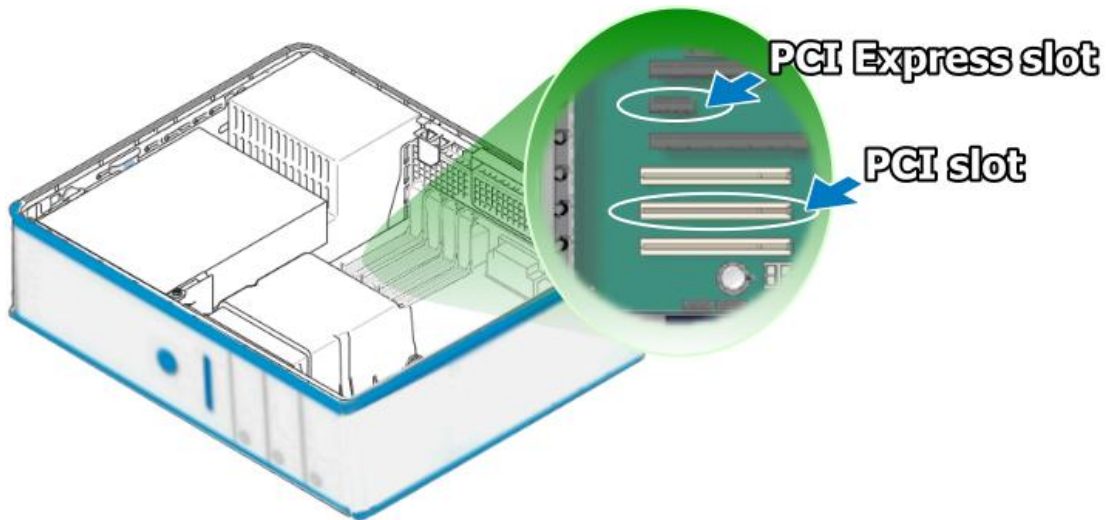

Step 6: Remove the screw holding the cover for the PCI/PCI Express slot in place and then remove the slot cover from the PC. Ensure that you do not misplace the screw.

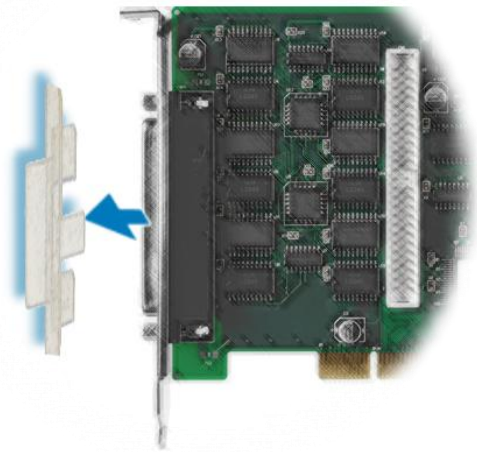
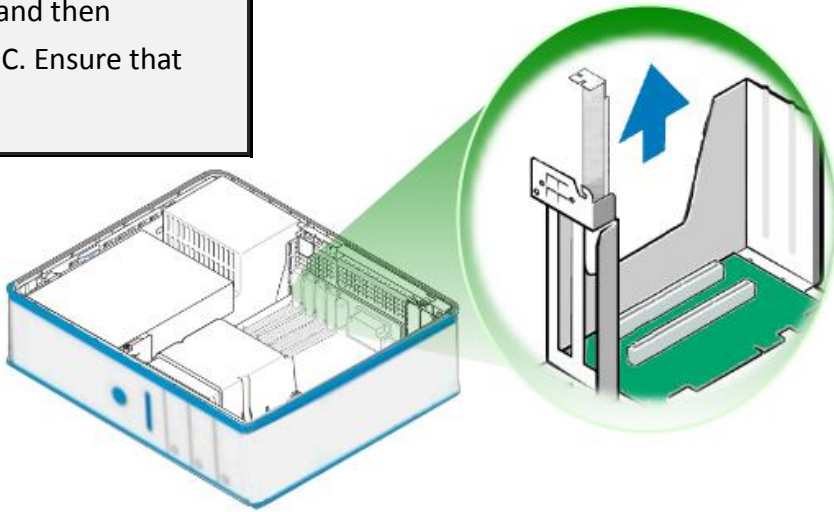

Step 7: Remove the connector cover from the PIO-D96 series card.

Step 8: Align the contacts of the PCI/PCI Express card with the open slot on your motherboard and carefully insert your PIO-D96 series card into the PCI/PCI Express slot.

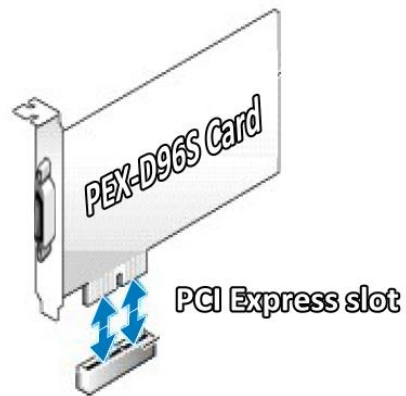
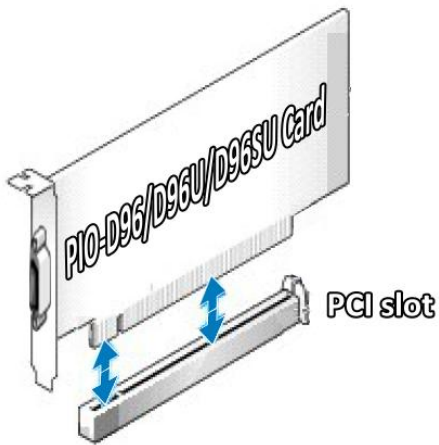

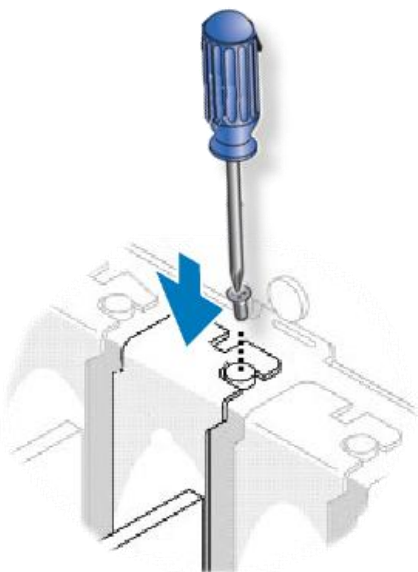

Step 9: Screw the mounting bracket screw removed in step 5 into the new PCI/PCI Express card bracket to secure the card in place.

Confirm that the PIO-D96 series card is correctly mounted on the motherboard.

Step 10: Re-attach cover for the computer and reconnect the power supply.

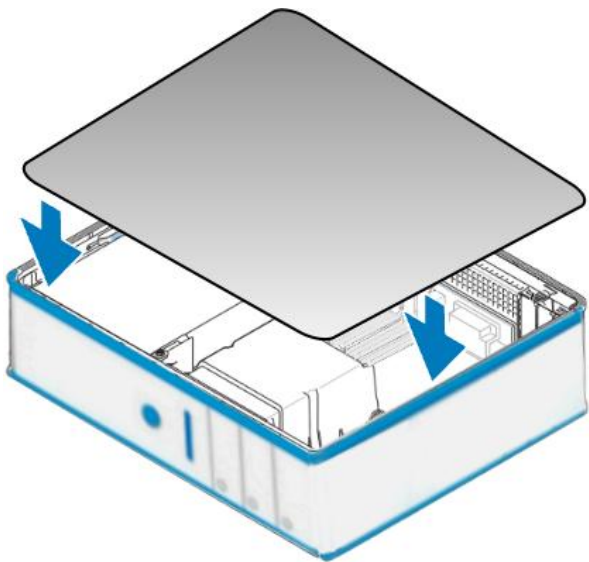

Step 11: Power on the computer.



Follow the prompt message to finish the Plug&Play steps, please refer to [Chapter 4 Software Installation](#).

4. Software Installation

This chapter provides a detailed description of the process for installing the PIO-D96 series driver and how to verify whether the PIO-D96 was properly installed. PIO-D96 series card can be used on DOS, Linux and Windows 98/ME/2000 and 32-/64-bit XP/2003/Vista/7/8 based systems, and the drivers are fully Plug &Play (PnP) compliant for easy installation.

4.1 Obtaining/Installing the Driver Installer Package

The driver installer package for the PIO-D96 series card can be found on the supplied CD-ROM, or can be obtained from the ICP DAS FTP web site. Install the appropriate driver for your operating system. The location and addresses are indicated in the Table4-1 and Table4-2 below.

Table 4-1: UniDAQ Driver/SDK

OS	Windows 2000 、 32/64-bit Windows XP 、 32/64-bit Windows 2003 、 32/64-bit Windows Vista 、 32/64-bit Windows 7 、 32/64-bit Windows 2008 、 32/64-bit Windows 8
Driver Name	UniDAQ Driver/SDK (unidaq_win_setup_xxxx.exe)
CD-ROM	CD:\\ NAPDOS\\PCI\\UniDAQ\\DLL\\Driver\\
Web Site	http://ftp.icpdas.com/pub/cd/iocard/pci/napdos/pci/unidaq/dll/driver/
Installing Procedure	For detailed information about the UniDAQ driver installation, please refer to UniDAQ DLL Software Manual. The user manual is contained in: CD:\\NAPDOS\\PCI\\UniDAQ\\Manual\\ http://ftp.icpdas.com/pub/cd/iocard/pci/napdos/pci/unidaq/manual/

Table 4-2: PIO-DIO Series Classic Driver

OS	Windows 95/98/ME 、 Windows NT 、 Windows 2000 、 32-bit Windows XP 、 32-bit Windows 2003 、 32-bit Windows Vista 、 32-bit Windows 7
Driver Name	PIO-DIO Series Classic Driver(PIO_DIO_Win__vxxx.exe)
CD-ROM	CD:\\ NAPDOS\\PCI\\PISO-DIO\\DLL_OCX\\Driver\\
Web Site	http://ftp.icpdas.com/pub/cd/iocard/pci/napdos/pci/pio-dio/dll_ocx/driver/
Installing Procedure	<p>For detailed information about the PIO-DIO series classic driver installation, please refer to PIO-DIO series classic driver DLL Software Manual.</p> <p>The user manual is contained in:</p> <p>CD:\\NAPDOS\\PCI\\PISO-DIO\\Manual\\</p> <p>http://ftp.icpdas.com/pub/cd/iocard/pci/napdos/pci/pio-dio/dll_ocx/driver/</p>

4.2 PnP Driver Installation

Power off the computer and install the PIO-D96 series cards. Turn on the computer and Windows 95/98/ME/NT/2000 and 32-/64-bit Windows XP/2003/Vista/7/8 should automatically detect the new PCI device(s) and then ask for the location of the driver files for the hardware. If a problem is encountered during installation, refer to the PnPinstall.pdf file for more information.

4.3 Verifying the Installation

To verify the installation, use the Windows **Device Manager** to view and update the device drivers installed on your computer, and check to ensure that hardware is operating correctly. The following is a description of how access the Device Manager in each of the major versions of Windows. Refer to the appropriate description for your specific operating system to verify the installation.

4.3.1 How do I get into Windows Device Manager?

■ Microsoft Windows 95/98/ME

Step 1: On the desktop right-click on **“My Computer”** and click **“Properties”** or open the **“Control Panel”** and double-click the **“System”** icon.

Step 2: Click the **“Device Manager”** tab.

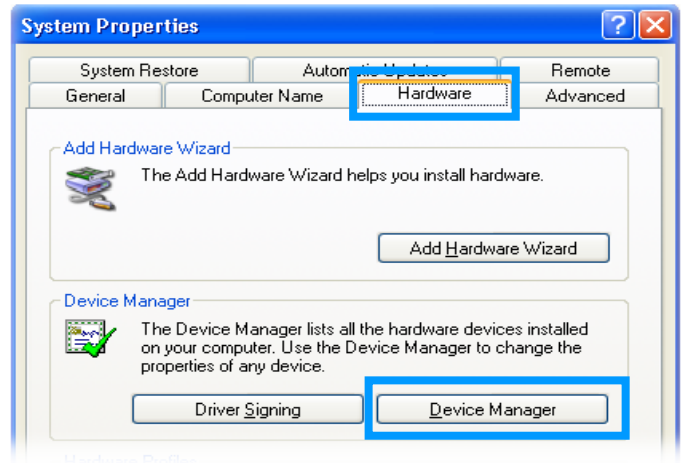

■ Microsoft Windows 2000/XP

Step 1: Click **“Start”** → then point to **“Settings”** and click → **“Control Panel”**. Double-click the **“System”** icon to open the **“System Properties”** dialog box..

Step 2: Click the **“Hardware”** tab and then click the **“Device Manager”** button.

■ Microsoft Windows 2003

Step 1: Click **“Start”** → point to **“Administrative Tools”**, and then click **“Computer Management”**.

Step 2: From **“System Tools”** in the console tree, click **“Device Manager”**.

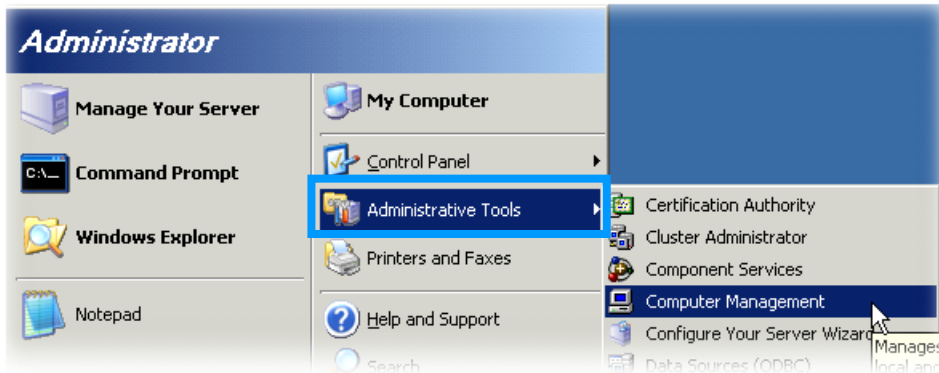

■ Microsoft Windows Vista/7

Step 1: Click **“Start”** button, and then click **“Control Panel”**.

Step 2: Click **“System and Maintenance”**, and then click **“Device Manager”**.

Alternatively,

Step 1: Click **“Start”** button.

Step 2: In the **Search field**, type **Device Manager** and the press Enter.

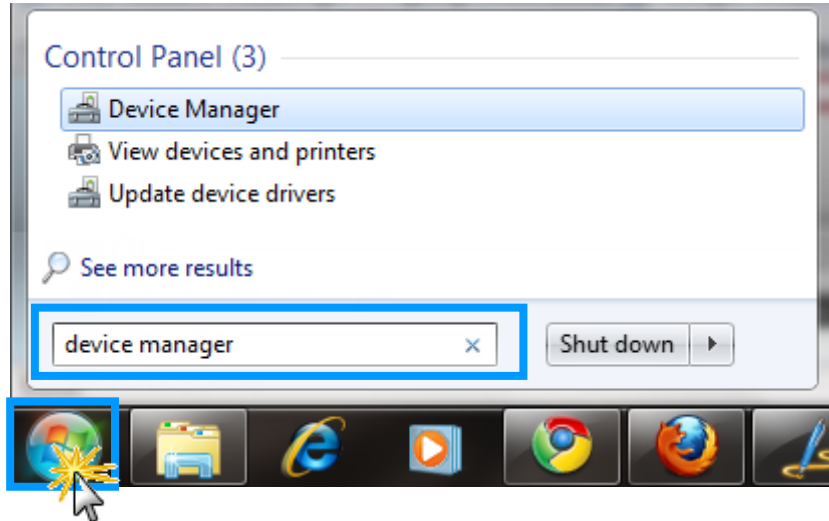

Note that Administrator privileges are required for this operation. If you are prompted for an administrator password or confirmation, type the password or provide confirmation.

■ Microsoft Windows 8

Step 1: To display the **Start screen icon** from the desktop view, simply hover the mouse cursor over the **bottom-left corner** of screen.

Step 2: **Right-click** the Start screen icon then click **“Device Manager”**.

Alternatively, press **[Windows Key] +[X]** to open the Start Menu, and select Device Manager from the options list.

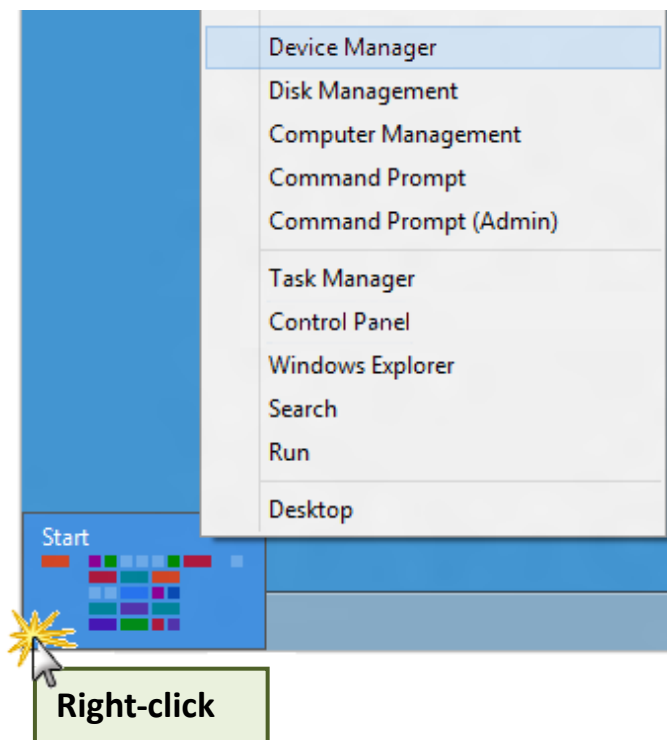

4.3.2 Check that the Installation

Check the PIO-D96 series card which listed correctly or not, as illustrated below.

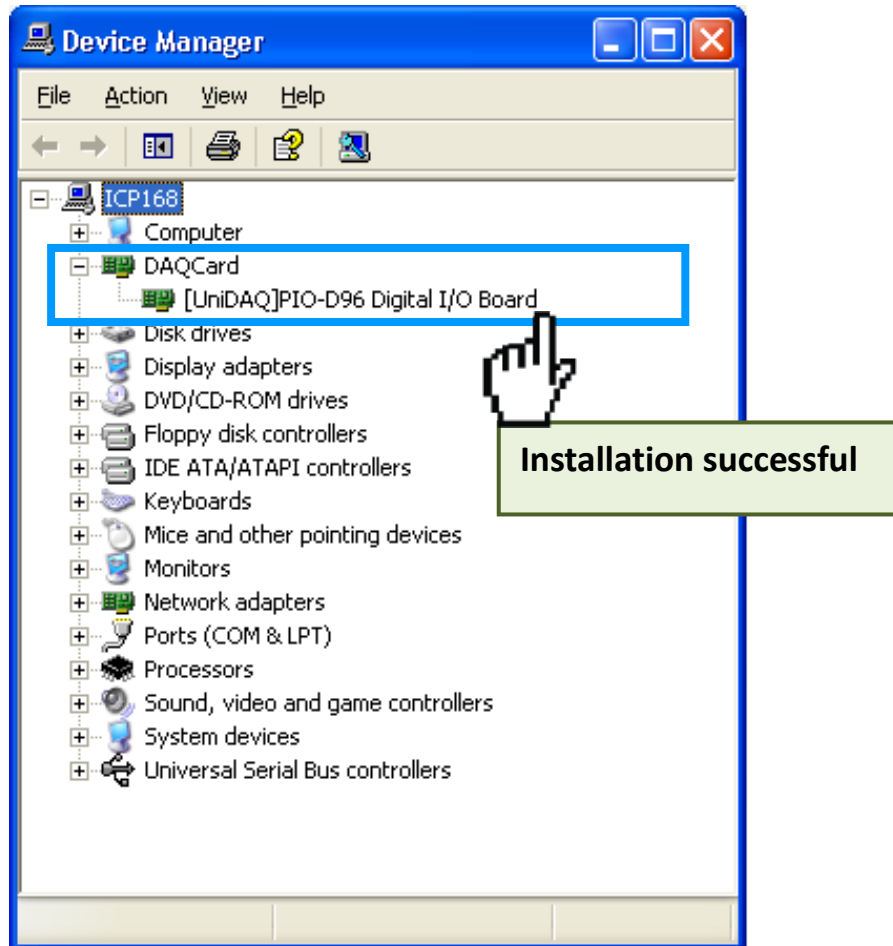

5. Testing PIO-D96 Series Card

This chapter can give you the detail steps about self-test. In this way, user can confirm that PIO-D96 series cards well or not. Before the self-test, you must complete the hardware and driver installation. For detailed information about the hardware and driver installation, please refer to [Chapter 3 Hardware Installation](#) and [Chapter 4 Software Installation](#).

5.1 Self-Test Wiring

5.1.1 PIO-D96 and PIO-D96U

■ Preparing the device:

Before beginning the “self-test”, ensure that the following items are available:

- A CA-3710 (optional) cable
- A DN-37 (optional) terminal board

Step 1: Use the DN-37 (optional) to connect the CON1 on the PIO-D96/D96U card.

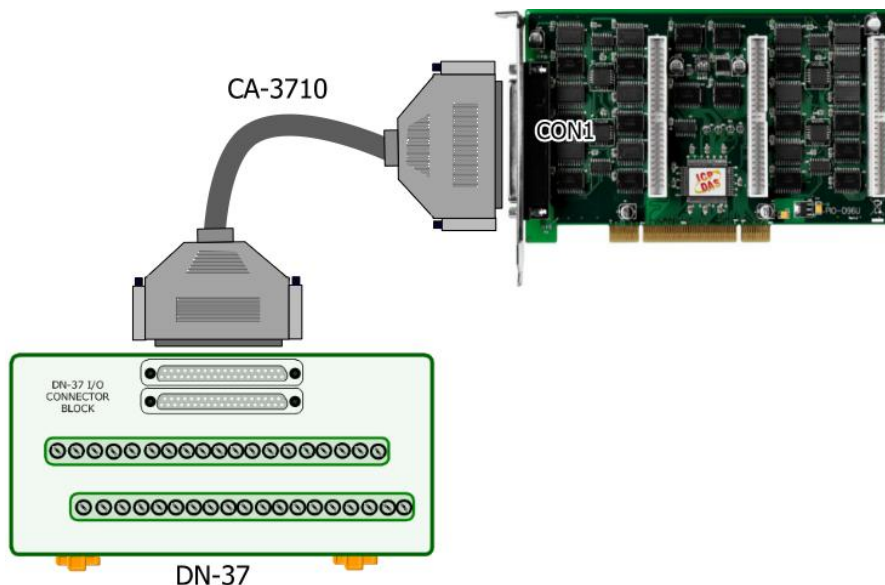

Step 2: Connect the Port0 (PA0 ~ PA7) with Port1 (PB0 ~ PB7).

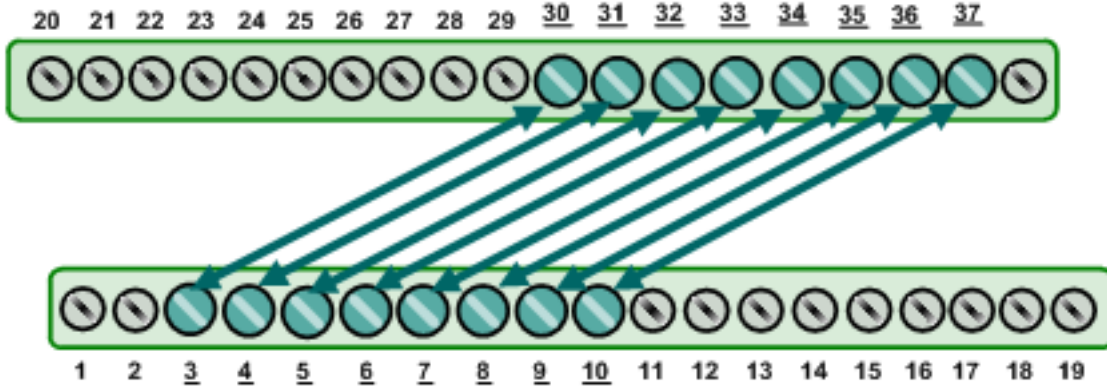

5.1.2 PIO-D96SU and PEX-D96S

■ Preparing the device:

Before beginning the “self-test”, ensure that the following items are available:

- A CA-SCSI100-15 (optional) cable
- A DN-100 (optional) terminal board

Step 1: Use DN-100 wiring terminal board (optional) to connect the CON1 on the PIO-D96SU/PEX-D96S card.

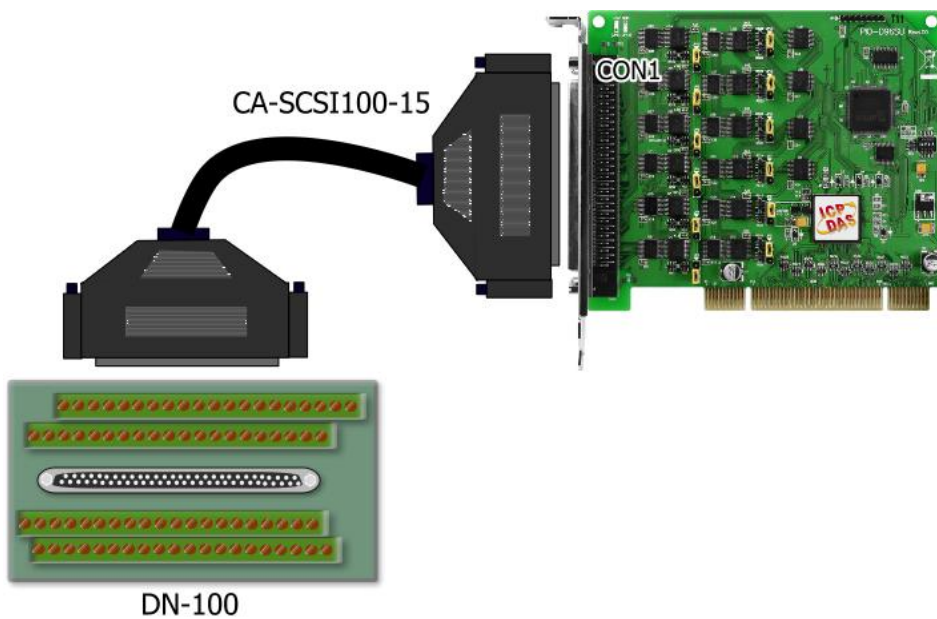

Step 2: Connect the Port0 (PA00 ~ PA07) with Port1 (PB00 ~ PB07).

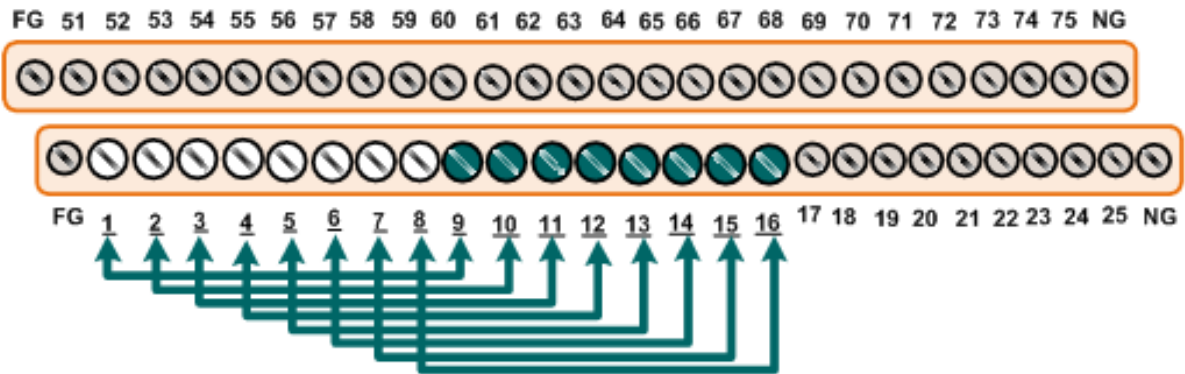

5.2 Execute the Test Program

The following example use UniDAQ driver to perform self-test. If you install the PIO-DIO series classic driver, please refer to Quick Start Guide of the PIO-D96 (<http://ftp.icpdas.com/pub/cd/iocard/pci/napdos/pci/pio-dio/manual/quickstart/classic/>) to execute the self-test.

Step 1: Execute the UniDAQ Utility Program. The UniDAQ Utility.exe will be placed in the default path (C:\ICPDAS\UniDAQ\Driver\) after completing installation.

1. Double click the “UniDAQUtility.exe”
2. Confirm the PIO-D96 series card had successfully installed to PC. It starts form 0.
3. Click the “TEST” button to start test.



Note:
The PIO-D96U/D96SU and PEX-D96S software is fully compatible with the PIO-D96 series software.

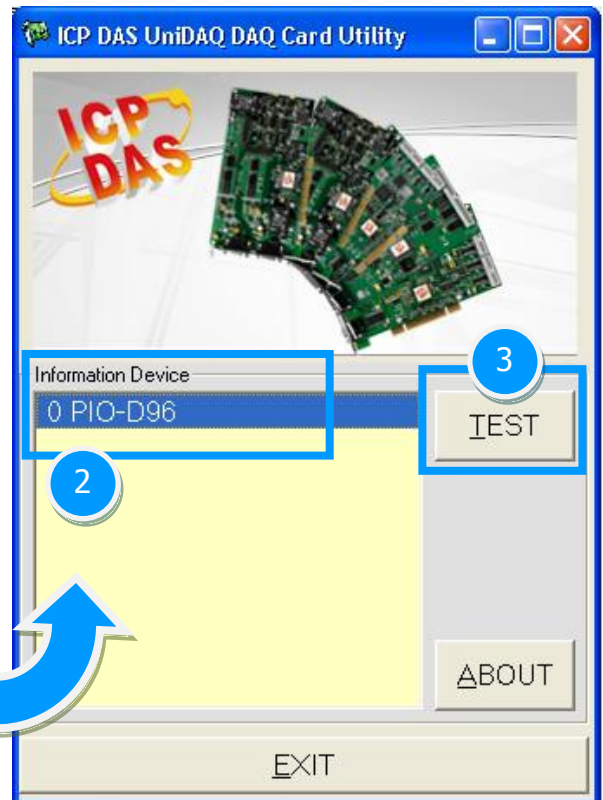

Step 2: Get DIO function test result.

1. Click the **“Digital Output”** tab.
2. Select the **“Port1”** from the **“Port Number”** drop-down options.
3. Check **channels 0, 2, 4 and 6**.

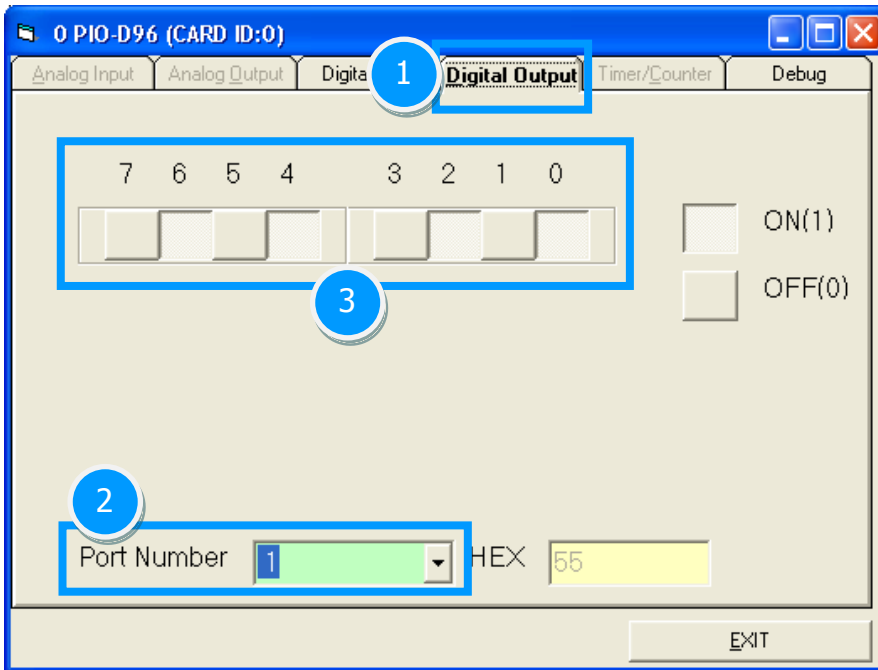

4. Click the **“Digital Input”** tab.
5. Select the **“Port0”** from the **“Port Number”** drop-down options.
6. The corresponding DI become **red** for channel 0, 2, 4, 6 of DO is **ON**.

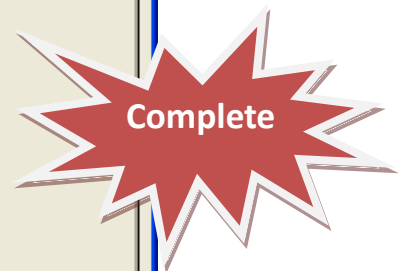
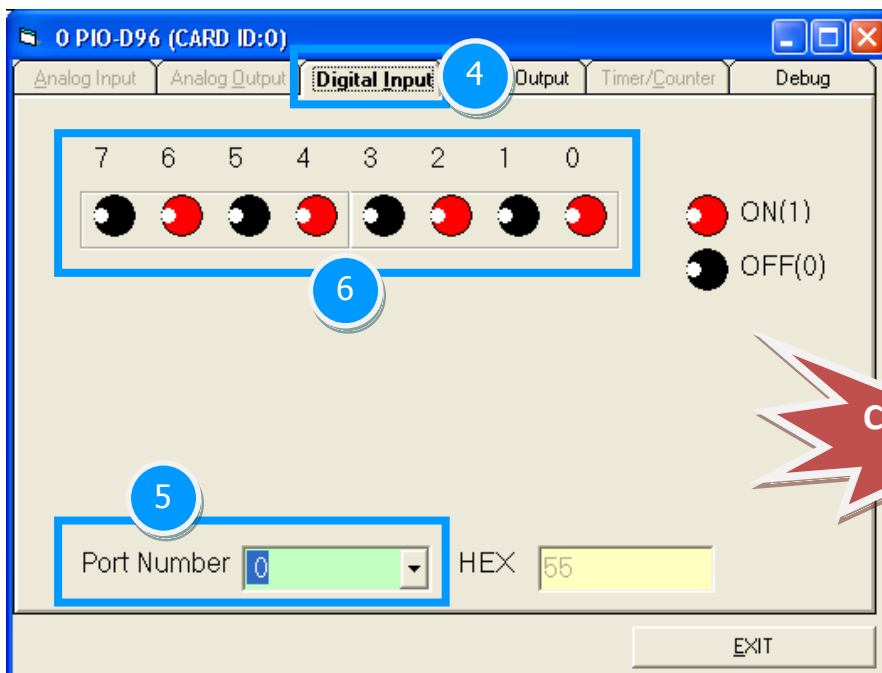

6. I/O Control Register

6.1 How to Find the I/O Address

The plug&play BIOS will assign a proper I/O address to every PIO/PISO series card in the power-on stage. The fixed IDs for the PIO-D96 series cards are given as follows:

Table 6-1:

	PIO-D96 (Rev 1.0 ~ 3.0)	PIO-D96 (Rev 4.0 or above)
Vendor ID	0xE159	0xE159
Device ID	0x0002	0x0001
Sub-Vendor ID	0x80	0x5880
Sub-Device ID	0x01	0x01
Sub-Aux ID	0x10	0x10

Table 6-2:

	PIO-D96U (Rev 1.0 or above)	PIO-D96SU (Rev 1.0 or above)	PEX-D96S (Rev 1.0 or above)
Vendor ID	0xE159	0xE159	0xE159
Device ID	0x0001	0x0001	0x0001
Sub-Vendor ID	0x5880	0x1880	0x1880
Sub-Device ID	0x01	0x01	0x01
Sub-Aux ID	0x10	0x10	0x10

We provide all necessary functions as follows:

1. `PIO_DriverInit(&wBoard, wSubVendor, wSubDevice, wSubAux)`
2. `PIO_GetConfigAddressSpace(wBoardNo, *wBase, *wIrq, *wSubVendor, *wSubDevice, *wSubAux, *wSlotBus, *wSlotDevice)`
3. `Show_PIO_PISO(wSubVendor, wSubDevice, wSubAux)`

For more information about all functions defined, refer to **PIO-DIO DLL software manual**. The important driver information is given as follows:

1. Resource-allocated information:

- **wBase:** BASE address mapping in this PC
- **wIrq:** IRQ channel number allocated in this PC

2. PIO/PISO identification information:

- **wSubVendor:** subVendor ID of this board
- **wSubDevice:** subDevice ID of this board
- **wSubAux:** subAux ID of this board

3. PC's physical slot information:

- **wSlotBus:** hardware slot ID1 in this PC's slot position
- **wSlotDevice:** hardware slot ID2 in this PC's slot position

The PIO_PISO.EXE utility will detect and show all PIO/PISO cards installed in this PC. Refer to [Sec. 6.1.1](#) for more information.

6.1.1 PIO_PISO Utility

The PIO_PISO.EXE is valid for all PIO/PISO cards. This program shows all PCI hardware ID regarding the PIO and PISO series DAQ cards. It is useful to test if the card Plug & Play successfully when the computer bootup. If the PIO or PISO series card does not shown in the screen correctly, please try to use another PCI slot and try again.

The user can execute the PIO_PISO.EXE to get the following information:

- List all PIO/PISO cards installed in this PC
- List all resources allocated to every PIO/PISO cards
- List the wSlotBus and wSlotDevice for specified PIO/PISO card identification. (refer to [Sec. 6.2](#) for more information about the assignment of I/O Address)

■ For Windows OS

The **PIO_PISO.EXE** for Windows is contained in:



CD:\NAPDOS\PCI\Utility\Win32\PIO_PISO



http://ftp.icpdas.com/pub/cd/iocard/pci/napdos/pci/utility/win32/pio_piso/

After executing the utility, the detail information for all PIO/PISO cards that installed in the PC will be shown as follows:

Figure 6-1:

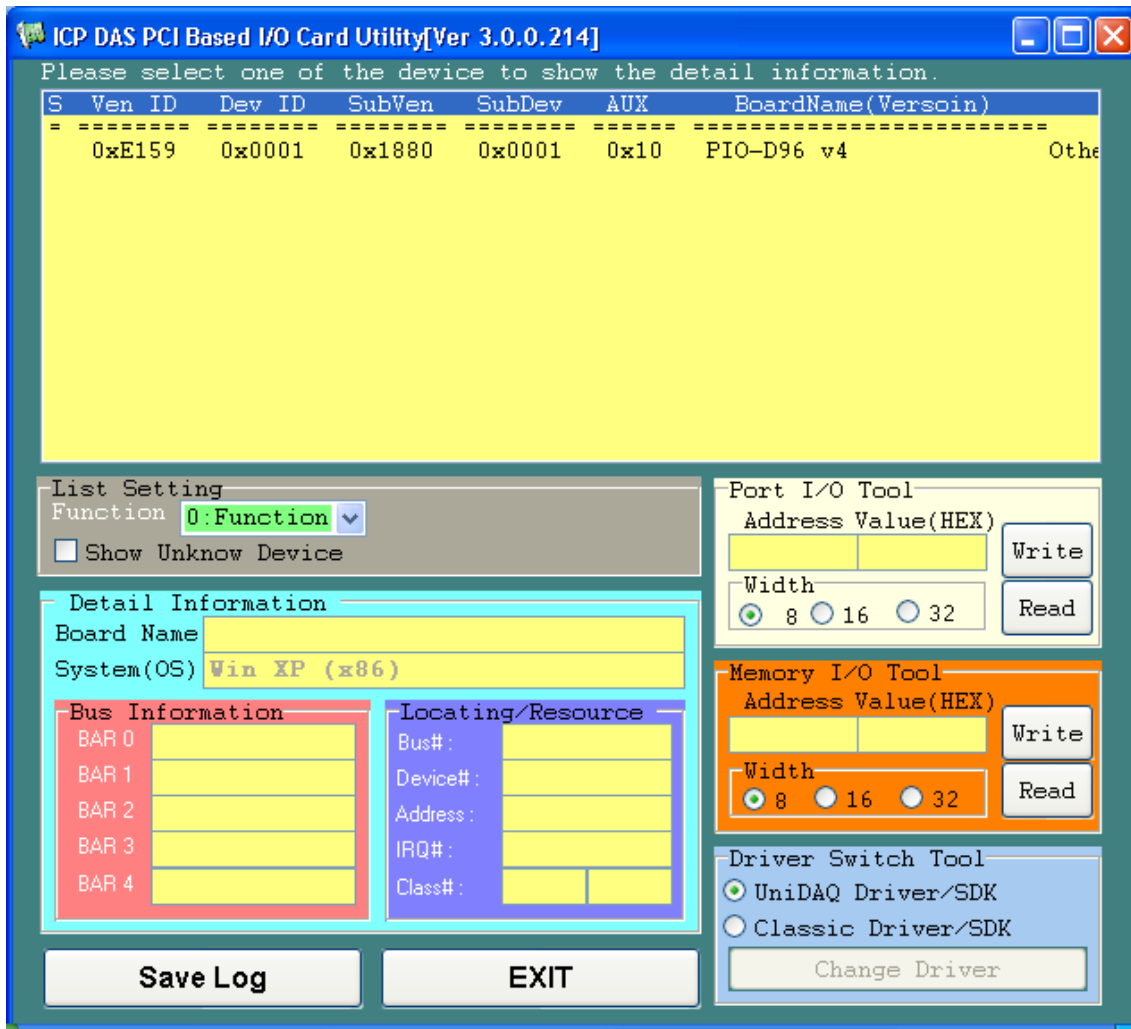

■ For DOS

The **PIO_PISO.EXE** for DOS is contained in:



CD:\NAPDOS\PCI\Utility\DOS\



<http://ftp.icpdas.com/pub/cd/iocard/pci/napdos/pci/utility/dos/>

The PIO_PISO program source is given as follows:

```
/* ----- */
/* Find all PIO_PISO series cards in this PC system */
/* step 1 : plug all PIO_PISO cards into PC */
/* step 2 : run PIO_PISO.EXE */
/* ----- */

#include "PIO.H"

WORD wBase,wIrq;
WORD wBase2,wIrq2;

int main()
{
int i,j,j1,j2,j3,j4,k,jj,dd,j11,j22,j33,j44;
WORD wBoards,wRetVal;
WORD wSubVendor,wSubDevice,wSubAux,wSlotBus,wSlotDevice;
char c;
float ok,err;

clrscr();
wRetVal=PIO_DriverInit(&wBoards,0xff,0xff,0xff); /*for PIO-PISO */
printf("\nThrer are %d PIO_PISO Cards in this PC",wBoards);
if (wBoards==0 ) exit(0);

printf("\n-----");
for(i=0; i<wBoards; i++)
{
PIO_GetConfigAddressSpace(i,&wBase,&wIrq,&wSubVendor,
&wSubDevice,&wSubAux,&wSlotBus,&wSlotDevice);

printf("\nCard_ %d:wBase=%x,wIrq=%x,subID=[%x,%x,%x],
SlotID=[%x,%x]",i,wBase,wIrq,wSubVendor,wSubDevice,
wSubAux,wSlotBus,wSlotDevice);

printf(" --> ");
ShowPioPiso(wSubVendor,wSubDevice,wSubAux);
}

PIO_DriverClose();
}
```

6.2 The Assignment of I/O Address

The Plug&Play BIOS will assign the proper I/O address to a PIO/PISO series card. If there is only one PIO/PISO board, the user can identify the board as card_0. If there are two PIO/PISO boards in the system, it is very difficult to identify which board is card_0. The software driver can support a maximum of 16 boards. Therefore, the user can install 16 PIO/PSIO series cards onto one PC system. The methods used to find and identify card_0 and card_1 is demonstrated below.

The simplest way to identify which card is card_0 is to use wSlotBus and wSlotDevice in the following manner:

Step 1: Remove all PIO-D96 series boards from the PC.

Step 2: Install one PIO-D96 series into the PC's PCI_slot1, run PIO_PISO.EXE.

Then record the wSlotBus1 and wSlotDevice1 information.

Step 3: Remove all PIO-D96 series boards from the PC.

Step 4: Install one PIO-D96 series into the PC's PCI_slot2 and run PIO_PISO.EXE.

Then record the wSlotBus2 and wSlotDevice2 information.

Step 5: Repeat Steps(3) and (4) for every PCI_slot and record all information from wSlotBus and wSlotDevice.

The records may look similar to the table follows:

Table 6-3:

PC's PCI Slot	WslotBus	WslotDevice
Slot_1	0	0x07
Slot_2	0	0x08
Slot_3	0	0x09
Slot_4	0	0x0A
PCI-BRIDGE		
Slot_5	1	0x0A
Slot_6	1	0x08
Slot_7	1	0x09
Slot_8	1	0x07

The above procedure will record all the wSlotBus and wSlotDevice information on a PC. These values will be mapped to this PC's physical slot and this mapping will not be changed for any PIO/PISO cards. Therefore, this information can be used to identify the specified PIO/PISO card by following steps:

Step1: Using the wSlotBus and wSlotDevice information from Table 6-3.

Step2: Enter the board number into PIO_GetConfigAddressSpace(...) function to get the information for a specific card, especially the wSlotBus and wSlotDevice details.

Step3: Identify the specific PIO/PISO card by comparing the data of the wSlotBus and wSlotDevice from Step1 and Step2.



Note that normally the card installed in slot 0 is card0 and the card installed in slot1 is card1 for PIO/PISO series cards.

6.3 The I/O Address Map

The I/O address for PIO-D96 series cards are automatically assigned by the main board ROM BIOS. The I/O address can also be re-assigned by the user. It is strongly recommended that users do not change the I/O address. The Plug & Play BIOS will effectively perform the assignment of proper I/O addresses to each PIO-D96 series card. The I/O address for the PIO-D96/D96U/D96SU and PEX-D96S are given in the table below, all of which are based on the base address of each card.

Table 6-4: Refer to [Sec. 6.1](#) for more information about wBase.

Address	Read	Write
wBase+0	-	RESET\ Control Register
wBase+2	Aux control register	Same
wBase+3	Aux data register	Same
wBase+5	INT mask control register	Same
wBase+7	Aux pin status register	Same
wBase+0x2a	INT polarity control register	Same
wBase+0xc0	Read Port0	Write Port0
wBase+0xc4	Read Port1	Write Port1
wBase+0xc8	Read Port2	Write Port2
wBase+0xcc	-	Port0~Port2 Configuration
wBase+0xd0	Read Port3	Write Port3
wBase+0xd4	Read Port4	Write Port4
wBase+0xd8	Read Port5	Write Port5
wBase+0xdc	-	Port3~Port5 Configuration
wBase+0xe0	Read Port6	Write Port6
wBase+0xe4	Read Port7	Write Port7
wbase+0xe8	Read Port8	Write Port8
wBase+0xec	-	Port6~Port8 Configuration
wBase+0xf0	Read Port9	Write Port9
wBase+0xf4	Read Port10	Write Port10
wBase+0xf8	Read Port11	Write Port11
wBase+0xfc	Read Card ID	Port9~Port11 Configuration

6.3.1 RESET\ Control Register

(Write): wBase+0

Bit 7	Bit 6	Bit 5	Bit 4	Bit 3	Bit 2	Bit 1	Bit 0
Reserved	Reserved	Reserved	Reserved	Reserved	Reserved	Reserved	RESET\

When the PC's power is first turned on, RESET\ signal is in a Low-state. **This will disable all DI/O operations.** The user has to set the RESET\ signal to a High-state before any DI/O command applications are initiated.

For example:

```

outputb (wBase,1);      /* RESET\=High → all DI/O are enable now */
outputb (wBase,0);     /* RESET\=Low → all DI/O are disable now */
    
```

6.3.2 AUX Control Register

(Read/Write): wBase+2

Bit 7	Bit 6	Bit 5	Bit 4	Bit 3	Bit 2	Bit 1	Bit 0
Aux7	Aux6	Aux5	Aux4	Aux3	Aux2	Aux1	Aux0

Aux?=0 → this Aux is used as a DI

Aux?=1 → this Aux is used as a DO

When the PC is first turned on, all Aux signals are in a Low-state. All Aux are designed as DI for all PIO/PISO series.

6.3.3 Aux Data Register

(Read/Write): wBase+3

Bit 7	Bit 6	Bit 5	Bit 4	Bit 3	Bit 2	Bit 1	Bit 0
Aux7	Aux6	Aux5	Aux4	Aux3	Aux2	Aux1	Aux0

When the Aux is used for DO, the output state is controlled by this register. This register is designed for feature extension. Therefore, do not use this register.

6.3.4 INT Mask Control Register

(Read/Write): wBase+5

Bit 7	Bit 6	Bit 5	Bit 4	Bit 3	Bit 2	Bit 1	Bit 0
0	0	0	0	EN3	EN2	EN1	EN0

EN0=0 → Disable P2C0 of CN1 as an interrupt signal (Default).

EN0=1 → Enable P2C0 of CN1 as an interrupt signal

For example:

```

outputb(wBase+5,0);      /*Disable interrupt */
outputb(wBase+5,1);      /* Enable interrupt P2C0 */
outputb(wBase+5,0x0f);   /* Enable interrupt P2C0, P5C0,P8C0,P11C0 */
    
```

6.3.5 Aux Status Register

(Read/Write): wBase+7

Bit 7	Bit 6	Bit 5	Bit 4	Bit 3	Bit 2	Bit 1	Bit 0
Aux7	Aux6	Aux5	Aux4	Aux3	Aux2	Aux1	Aux0

Aux0=P2C0, Aux1=P5C0, Aux2=P8C0, Aux3=P11C0, Aux7~4=Aux-ID. Refer to DEMO5.C for more information. The Aux 0~3 are used as interrupt source. The interrupt service routine has to read this register to identify the interrupt source. Refer to [Sec. 2.7](#) for more information.

6.3.6 Interrupt Polarity Register

(Read/Write): wBase+0x2A

Bit 7	Bit 6	Bit 5	Bit 4	Bit 3	Bit 2	Bit 1	Bit 0
0	0	0	0	INV3	INV2	INV1	INV0

This register provides a function to control invert or non-invert for the interrupt signal source. A detailed application example is given below.

INV0=1 → select the non-inverted signal from P2C0

INV0=0 → select the inverted signal from P2C0

```

For example:
outputb(wBase+0x2a,0x0f); /* select the non-inverted input P2/5/8/11C0 */
outputb(wBase+0x2a,0x00); /* select the inverted input of P2/5/8/11C0 */
outputb(wBase+0x2a,0x0e); /* select the inverted input of P2C0 */
                          /* select the non-inverted input P5/8/11C0 */

outputb(wBase+0x2a,0x0c); /* select the inverted input of P2/5C0 */
                          /* select the non-inverted input P8/11C0 */
    
```

Refer to [Sec. 2.7](#) and DEMO5.C (DOS) for more information.

6.3.7 I/O Selection Control Register

(Write): wBase+0xcc

Bit 7	Bit 6	Bit 5	Bit 4	Bit 3	Bit 2	Bit 1	Bit 0
0	0	0	0	0	Port2	Port1	Port0

(Write): wBase+0xdc

Bit 7	Bit 6	Bit 5	Bit 4	Bit 3	Bit 2	Bit 1	Bit 0
0	0	0	0	0	Port5	Port4	Port3

(Write): wBase+0xec

Bit 7	Bit 6	Bit 5	Bit 4	Bit 3	Bit 2	Bit 1	Bit 0
0	0	0	0	0	Port8	Port7	Port6

(Write): wBase+0xfc

Bit 7	Bit 6	Bit 5	Bit 4	Bit 3	Bit 2	Bit 1	Bit 0
0	0	0	0	0	Port11	Port10	Port9

These registers provide the function for configuration digital input/output port of the PIO-D96 series Card. Every I/O port can be programmed to be a DI or a DO port. **Note that all ports are used as D/I ports when the PC is first turned on.**

port?=1 → this port is used as a DO port

port?=0 → this port is used as a DI port

For example:

```
outportb(wBase+0xcc,0x03);    /* set port0 ~ port1 as DO ports */
                               /* set port2 as DI ports */
```

```
outportb(wBase+0xdc,0x07);    /* set port3 ~ port5 as D/O ports */
outportb(wBase+0xec,0x00);    /* set port6 ~ port8 as DI ports */
```

6.3.8 Card ID Register

(Read): wBase+0xfc

Bit 7	Bit 6	Bit 5	Bit 4	Bit 3	Bit 2	Bit 1	Bit 0
0	ID3	ID2	ID1	ID0	0	0	0

For example:

```
wCardID = inportb(wBase+0xfc);           /* read Card ID */
```



Note: The Card ID function is only supported by the PIO-D96U/D96SU and PEX-D96S.

6.3.9 Read/Write 8-bit Data Register

(Read/Write): wBase+0xc0/0xc4/0xc8/0xd0/0xd4/0xd8

0xe0/0xe4/0xe8/0xf0/0xf4/0xf8

Bit 7	Bit 6	Bit 5	Bit 4	Bit 3	Bit 2	Bit 1	Bit 0
D7	D6	D5	D4	D3	D2	D1	D0

There are 12 8-bit I/O ports in the PIO-D96 series card. Every I/O port can be configured as DI or DO port. User can send/receive digital data to/from this register for digital input or output. **Note that all ports are used as D/I port when the PC is first turned on.**

For example:

```
outputb(wBase+0xc0,Val);           /* write to Port0 */
Val=inportb(wBase+0xc0);           /* read from Port0 */
```



Note: Make sure the I/O port configuration (DI or DO) before read/write the data register. (Refer to [Sec.6.3.7](#))

7. Demo Programs

7.1 Demo Program for Windows

All demo programs will not work properly if the DLL driver has not been installed correctly. During the DLL driver installation process, the install-shields will register the correct kernel driver to the operation system and copy the DLL driver and demo programs to the correct position based on the driver software package you have selected (Win98/Me/NT/2K and 32-/64-bit winXP/2003/Vista/7/8). Once driver installation is complete, the related demo programs and development library and declaration header files for different development environments will be presented as follows.

■ Demo Program for PIO-DIO Series Classic Driver

The demo program is contained in:



CD:\NAPDOS\PCI\PIO-DIO\DLL_OCX\Demo\



http://ftp.icpdas.com/pub/cd/iocard/pci/napdos/pci/pio-dio/dll_ocx/demo/

⊕ BCB4 → for Borland C++ Builder 4
PIODIO.H → Header files
PIODIO.LIB → Linkage library for BCB only

⊕ Delphi4 → for Delphi 4
PIODIO.PAS → Declaration files

⊕ VC6 → for Visual C++ 6
PIODIO.H → Header files
PIODIO.LIB → Linkage library for VC only

⊕ VB6 → for Visual Basic 6
PIODIO.BAS → Declaration files

⊕ VB.NET2005 → for VB.NET2005
PIODIO.vb → Visual Basic Source files

⊕ CSharp2005 → for C#.NET2005
PIODIO.cs → Visual C# Source files

For detailed information about the DLL function of the PIO-D96 series, please refer to PIO-DIO DLL Software Manual (CD:\NAPDOS\PCI\PIO-DIO\Manual\)

■ Demo Program for UniDAQ SDK Driver

The demo program is contained in:



CD:\NAPDOS\PCI\UniDAQ\DLL\Demo\



<http://ftp.icpdas.com/pub/cd/iocard/pci/napdos/pci/unidaq/dll/demo/>

⊕ BCB6 → for Borland C++ Builder 6
UniDAQ.H → Header files
UniDAQ.LIB → Linkage library for BCB only

⊕ Delphi6 → for Delphi 6
UniDAQ.PAS → Declaration files

⊕ VB6 → for Visual Basic 6
UniDAQ.BAS → Declaration files

⊕ CSharp2005 → for C#.NET2005
UniDAQ.cs → Visual C# Source files

⊕ VC6 → for Visual C++ 6
UniDAQ.H → Header files
UniDAQ.LIB → Linkage library for VC only

⊕ VB.NET2005 → for VB.NET2005
UniDAQ.vb → Visual Basic Source files

⊕ VC.NET2005 → for VC.NET2005 (32-bit)
UniDAQ.H → Header files
UniDAQ.LIB → Linkage library for VC only

⊕ VC.NET2005 → for VC.NET2005 (64-bit)
UniDAQ.H → Header files
UniDAQ.LIB → Linkage library for VC only

For detailed information about the DLL function and demo program of the UniDAQ, please refer to UniDAQ DLL Software Manual (CD:\NAPDOS\PCI\UniDAQ\Manual\)

7.2 Demo Program for DOS

The demo program is contained in:



CD:\NAPDOS\PCI\PIO-DIO\DOS\d96\



<http://ftp.icpdas.com/pub/cd/iocard/pci/napdos/pci/pio-dio/dos/d96/>

- ⊕ \TC*. * → for Turbo C 2.xx or above
- ⊕ \MSC*. * → for MSC 5.xx or above
- ⊕ \BC*. * → for BC 3.xx or above

- ⊕ \TC\LIB*. * → for TC Library
- ⊕ \TC\DEMO*. * → for TC demo program
- ⊕ \TC\DIAG*. * → for TC diagnostic program

- ⊕ \TC\LIB\PIO.H → TC Declaration File
- ⊕ \TC\LIB\TCPIO_L.LIB → TC Large Model Library File
- ⊕ \TC\LIB\TCPIO_H.LIB → TC Huge Model Library File

- ⊕ \MSC\LIB\PIO.H → MSC Declaration File
- ⊕ \MSC\LIB\MSCPIO_L.LIB → MSC Large Model Library File
- ⊕ \MSC\LIB\MSCPIO_H.LIB → MSC Huge Model Library File

- ⊕ \BC\LIB\PIO.H → BC Declaration File
- ⊕ \BC\LIB\BCPIO_L.LIB → BC Large Model Library File
- ⊕ \BC\LIB\BCPIO_H.LIB → BC Huge Model Library File

For detailed information about the DLL function of the DOS, please refer to PIO-DIO DLL Software Manual (CD:\NAPDOS\PCI\PIO-DIO\Manual\)

Appendix: Daughter Board

A1. DB-37, DN-37, DN-50 and DN-100

- **DB-37:** The DB-37 is a general purpose daughter board for D-sub 37 pins. It is designed for easy wire connection via pin-to-pin. Use a 37-pin cable (e.g. CA-3710 ,etc.) to connect DB-37 to CON1 of the PIO-D96/D96U.



DB-37

- **DN-37 and DN-50:** The DN-37 is a general purpose daughter board for DB-37 pins with DIN-Rail Mountings. The DN-50 is designed for 50-pin flat-cable headers with DIN-Rail mountings. They are also designed for easy wire connection via pin-to-pin.

Use a 37-pin cable (e.g. CA-3710 ,etc.) to connect to CON1 of the PIO-D96/D96U by DN-37, and then use a 50-pin cable (e.g. CA-5002 ,etc.) to connect to CN1/CN2/CN3 by DN-50.



DN-50

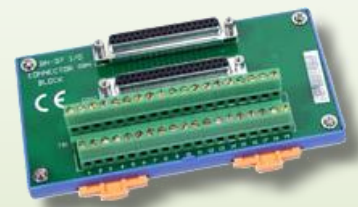

DN-37

- **DN-100:** The DN-100 is a general purpose daughter board for SCSI II 100 pins. It is designed for easy wire connection via pin-to-pin. Use a 100-pin SCSI II cable (e.g. CA-SCSI100-15 ,etc.) to connect DN-100 to CON1 of the PIO-D96SU and PEX-D96S.

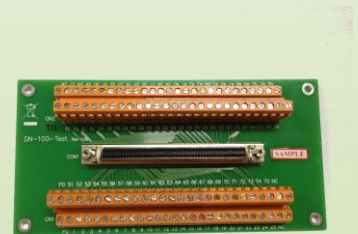

DN-100

A2. DB-8125

The DB-8125 is a general purpose screw terminal board. It is designed for easy wire connection. The DB-8125 consists of one DB-37 and two 20-pin flat-cable headers. Use a 37-pin cable (e.g. CA-3710 ,etc.) to connect DB-8125 to CON1 of the PIO-D96/D96U.

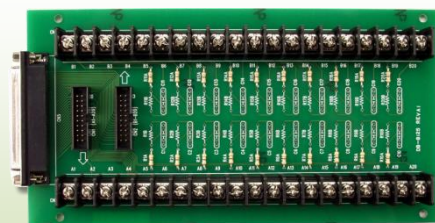

DB-8125

A3. ADP-37/PCI and ADP-50/PCI

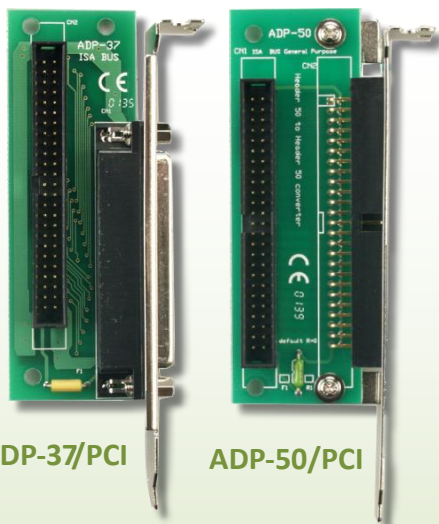

ADP-37/PCI

ADP-50/PCI

The ADP-37/PCI and ADP-50/PCI are extender for the 50-pin header. The one side of the ADP-37/PCI or the ADP-50/PCI can be connected to a 50-pin header. Note: that ADP-37/PCI is 50-pin header to DB-37 extender and ADP-50/PCI is 50-pin header to 50-pin header extender.

The other side can be mounted onto the PC chassis as is depicted by the following:

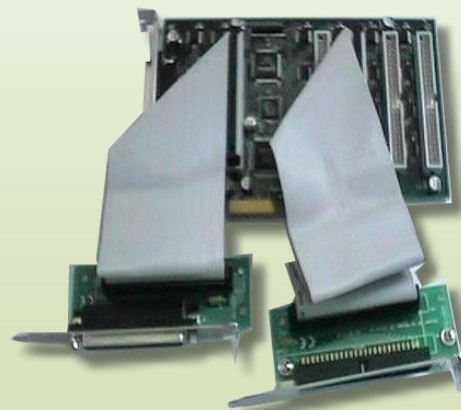

A4. DB-24P and DB-24PD Isolated Input Board

The DB-24P is a 24-channel isolated digital input daughter board. The optically isolated inputs of the DB-24P consist of a bi-directional optocoupler with a resistor for current sensing. You can use the DB-24P to sense DC signals from TTL levels up to 24 V or use the DB-24P to sense a wide range of AC signals. You can also use this board to isolate the computer from large common-mode voltage, ground loops and transient voltage spikes that often occur in industrial environments, as illustrated below. Table A4-1 is the comparison of DB-24P and DB-24PD.

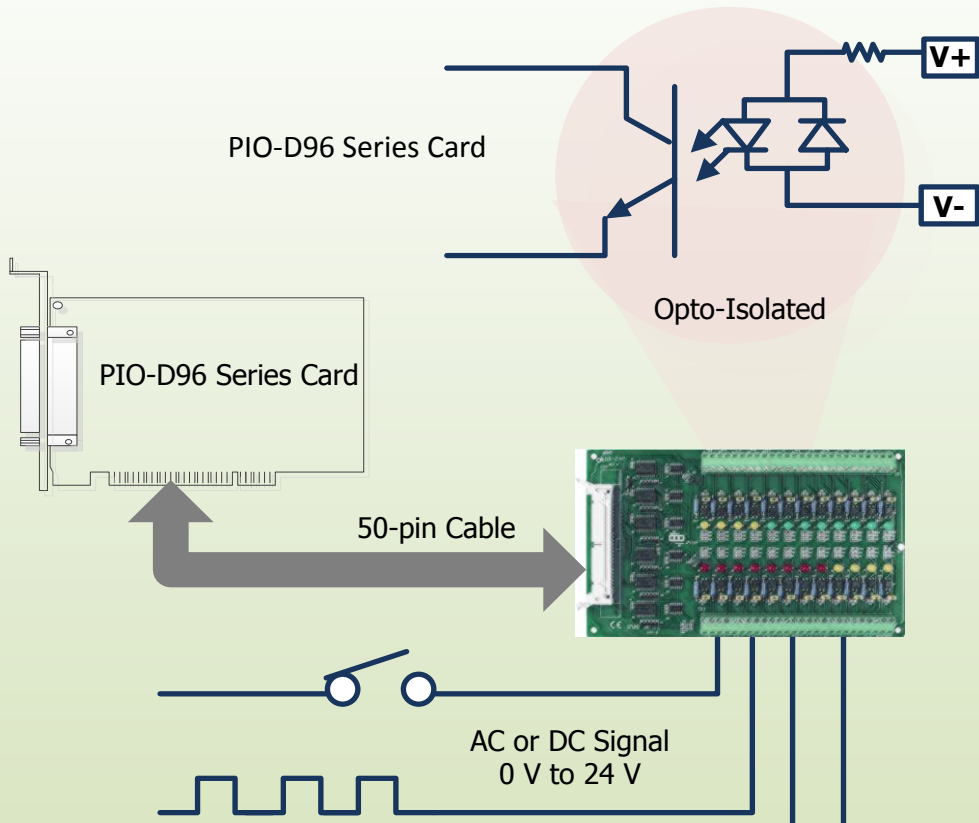
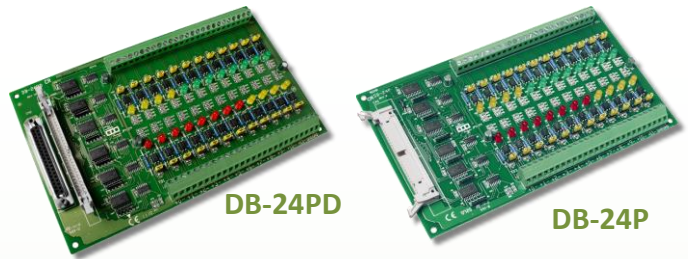
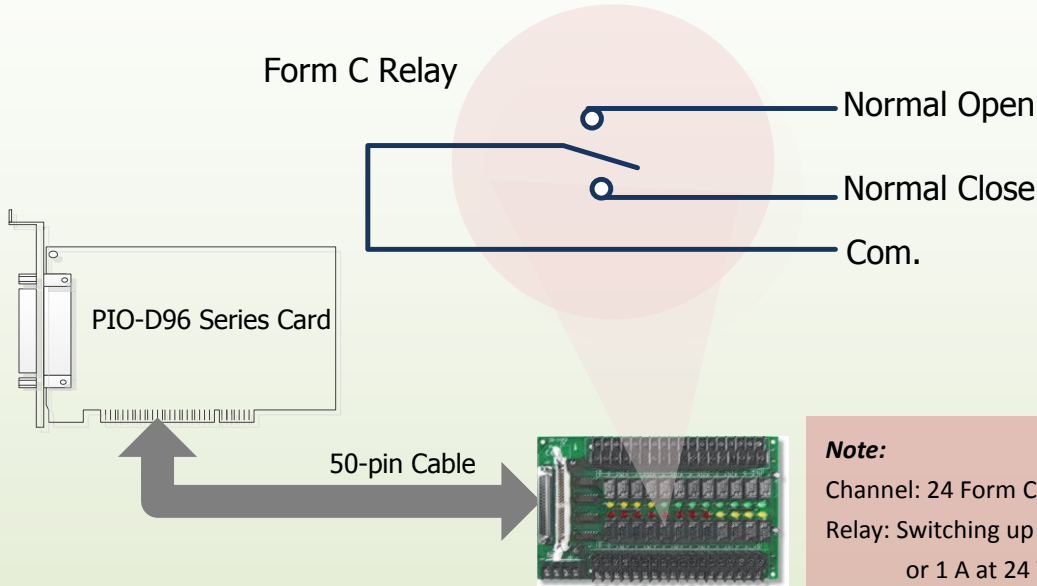
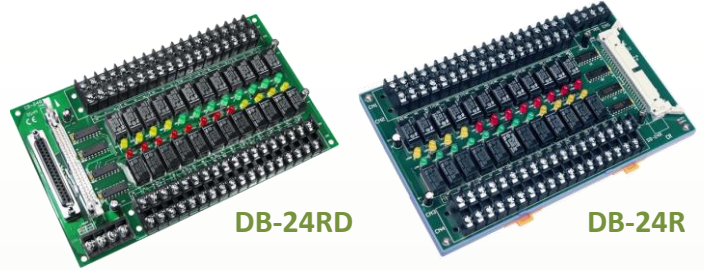

Table A4-1:

	DB-24P	DB-24PD
50-pin Flat-Cable Header	Yes	Yes
D-sub 37-pin Header	No	Yes
Other Specifications	Same	

A5. DB-24R and DB-24RD Relay Board

The DB-24R, 24-channel relay output board, consists of 24 form-C relays for efficiently controlling the switch with the use of an appropriately loaded program. The relays are energized by applying a 12 V/24 V voltage signal to the appropriate relay channel on the 50-pin flat-cable connector. There are 24 enunciator LEDs for each relay channel and the LED light will go on when their associated relay has been activated. The control scheme is illustrated below.



Note:
Channel: 24 Form C Relay
Relay: Switching up to 0.5 A at 110 V_{AC}
or 1 A at 24 V_{DC}

Table A5-1:

	DB-24R	DB24RD
50-pin Flat-Cable Header	Yes	Yes
D-sub 37-pin Header	No	Yes
Other Specifications	Same	

Table A5-2:

DB-24R, DB-24RD	24 * Relay (120 V, 0.5 A)
DB-24PR, DB-24PRD	24 * Power Relay (250 V, 5 A)
DB-24POR	24 * PhotoMOS Relay (350 V, 0.1 A)
DB-24SSR	24 * SSR (250 V _{AC} , 4 A)
DB-24C	24 * Open Collector (30 V, 100 mA)
DB-16P8R	16 * Relay (120 V, 0.5 A) + 8 * Isolated Input

A6. DB-24PR, DB-24POR and DB-24C

The DB-24PR, 24-channel power relay output board, consists of 8 form-C and 16 form-A electromechanical relays for efficiently controlling

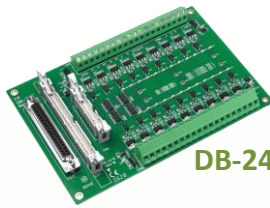

DB-24C



DB-24POR

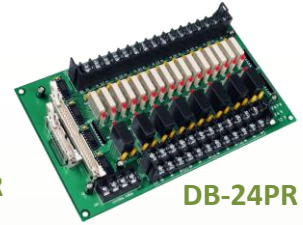

DB-24PR

the switch with the use of an appropriately loaded program. The contact of each relay can allow 5 A current load at 250 V_{AC}/30 V_{DC}. The relay is energized by applying a 5 voltage signal to the associate relay channel on the 20-pin flat-cable connector (just used 16 relays) or 50-pin flat-cable connector (OPTO-22 compatible, for DIO-24 series). 24 enunciator LEDs for indicating the status of for each relay and the corresponding LED light will go on when their associated relay has been activated. To avoid overloading your PC's power supply, this board needs a +12 V_{DC} or +24V_{DC} external power supply, as illustrated below.

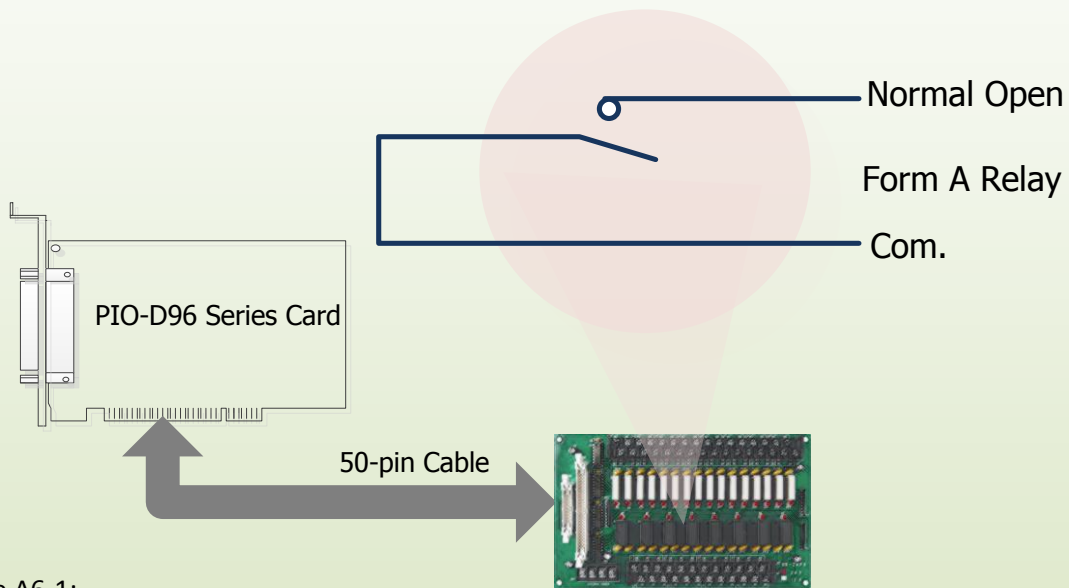

Table A6-1:

DB-24PR	24 * Power Relay, 5A/250 V
DB-24POR	24 * PhotoMOS Relay, 0.1 A/350 V _{AC}
DB-24C	24 * Open Collector, 100 mA per channel, 30 V max.

Note:

1. 50-Pin connector (OPTO-22 compatible) for DIO-24/48/144, PIO-D144/D96/D56/D48/D24/D168.
2. 20-Pin connector for 16 channel digital output (A-82X, A-62X, DIO-64, ISO-DA16/DA8).
3. Channel: 16 Form A Relay, 8 Form C Relay.
4. Relay: switching up to 5 A at 110 V_{AC}/5 A at 30 V_{DC}.

A7. Daughter Boards Comparison Table

Table A7-1 is the comparison table for the daughter application of PIO/PISO series cards.

Table A7-1:

I/O Card	-	PIO-D96 PIO-D96U	PIO-D96 PIO-D96U	PIO-D96SU PEX-D96S
Cable/ Daughter Boards	20-Pin Flat-Cable	50-Pin Flat-Cable	37-Pin D-sub	100-Pin SCSI II
DB-37	NO	NO	Yes	NO
DN-37	NO	NO	Yes	NO
ADP-37/PCI	NO	Yes	Yes	NO
ADP-50/PCI	NO	Yes	NO	NO
DB-24P	NO	Yes	NO	NO
DB-24PD	NO	Yes	Yes	NO
DB-16P8R	NO	Yes	Yes	NO
DB-24R	NO	Yes	NO	NO
DB-24RD	NO	Yes	Yes	NO
DB-24C	Yes	Yes	Yes	NO
DB-24PR	Yes	Yes	NO	NO
DB-24PRD	NO	Yes	Yes	NO
DB-24POR	Yes	Yes	Yes	NO
DB-24SSR	NO	Yes	Yes	NO
DN-100	NO	NO	NO	Yes