

GW-7553 PROFIBUS/Modbus TCP Gateway

Quick Start User Guide

1. Introduction

This manual introduces the GW-7553's basic setting and operating quickly, the user can refer to the user manual in the ICP DAS companion CD-ROM (Path: "CD:\profibus\gateway\gw-7553>manual\gw-7553 user manual.pdf").

This manual helps users to understand about the GW-7553 module and application. In the following examples the CIF50-PB PROFIBUS Master card from Hilscher is used. The configuration and communication is done by the program "SyCon" provided by Hilscher.

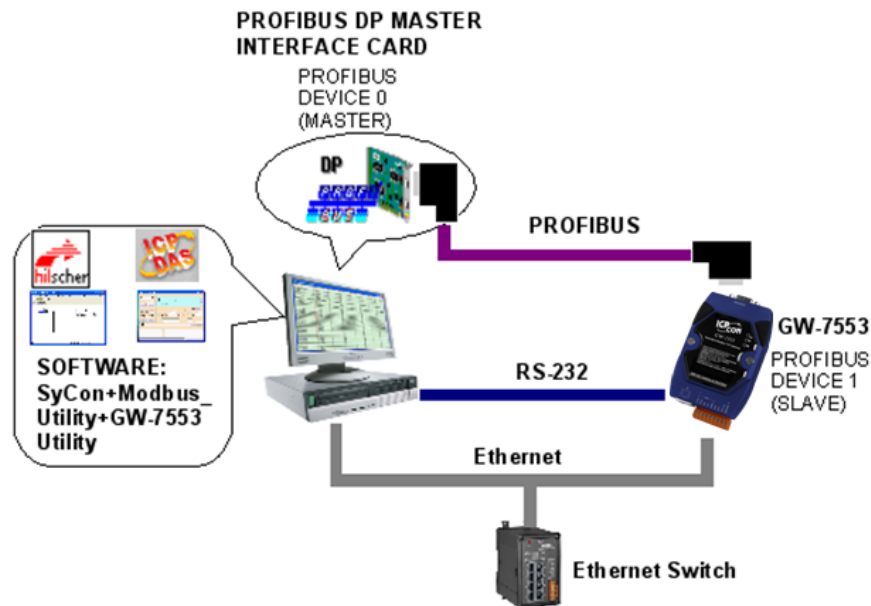

Application example of PROFIBUS to Modbus TCP

In this example the GW-7553 acts as a Modbus TCP Slave device. When the GW-7553 module receives a write DO Modbus command from PC's Ethernet Port, the GW-7553 module can send the message to the input data area of PROFIBUS Master station. When the GW-7553 module receives a read DI Modbus command from PC's Ethernet Port, GW-7553 module can refer to the output data area of PROFIBUS Master station to produce response message and send it to PC's Ethernet Port.

2. Hardware configuration

Power connection

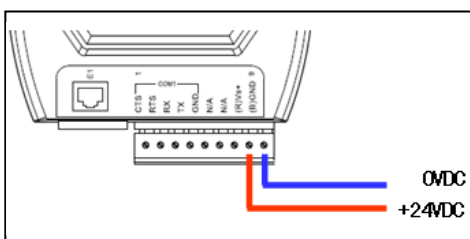

RS-232 connection

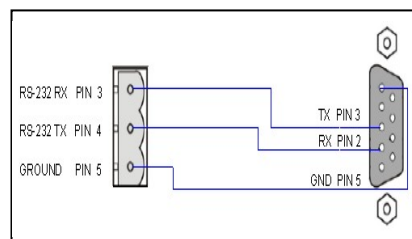

Ethernet connection

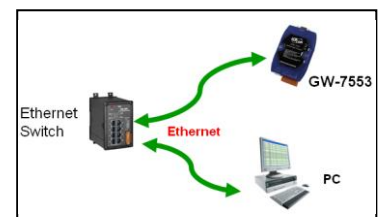

PROFIBUS connection

Here we recommend users to use the standard PROFIBUS cable and connector (DB9 male). It is only needed to use D-type connector via PROFIBUS cable to connect PROFIBUS Master station and GW-7553 module. PROFIBUS Master station and GW-7553 module belong to terminal equipments in this example, thus we need to enable the terminator resistor in the D-type connector.

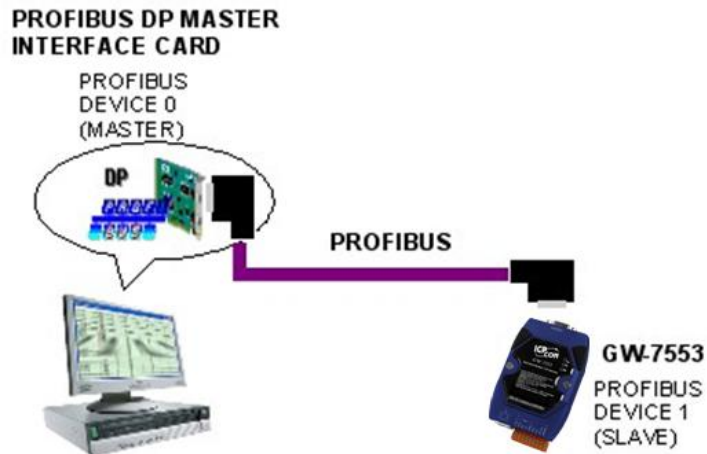

Address setting

The GW-7553 is a slave device of PROFIBUS DP protocol. The station address of GW-7553 can be set by DIP switch. The DIP switch can be seen by open the cover, as shown in the below. The range of DIP switch is 0~126, here we set GW-7553 module's DIP switch to 1.

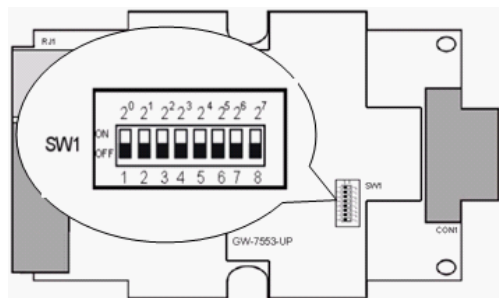

Station address	DIP switch (SW1)							
	1	2	3	4	5	6	7	8
1	1	0	0	0	0	0	0	0
10	0	1	0	1	0	0	0	0
31	1	1	1	1	1	0	0	0

Note: 1=>ON, 0=>OFF

LED status indicator

LED	Status	Description
PWR	flash	When the GW-7553 is a Modbus Slave device and receiving query message form Modbus Master device, PWR led will flash.
	on	Power supply is ok. The firmware has loaded.
	off	Power supply has failed.
ERR	flash	When the GW-7553 connects with the utility tool, it will flash fast (flash once about 55ms). When the GW-7553 has diagnostic message, it will flash slowly (flash once about 220ms).

	on	The connection is error with PROFIBUS Master device or PROFIBUS system configuration is not correct.
	off	PROFIBUS system configuration is correct. It is normal operation.
RUN	on	Data exchange mode. It is normal operation.
	off	GW-7553 module is not in data exchange mode.

3. Establish connection with GW-7553

Before establish the connection between DP-Master and GW-7553, users should obey the following steps first.

1. First, users must load the electronic device description file (GSD file) of the GW-7553 into the DP-Master.
2. And then set the parameters and configurations.
3. Finally change your DP-master from offline state to operate state. The GW-7553 will be initialized. If there is no error occurs, GW-7553 proceeds into data exchange state. At the meantime, if there is any error occurs, GW-7553 will return to wait for parameterization.

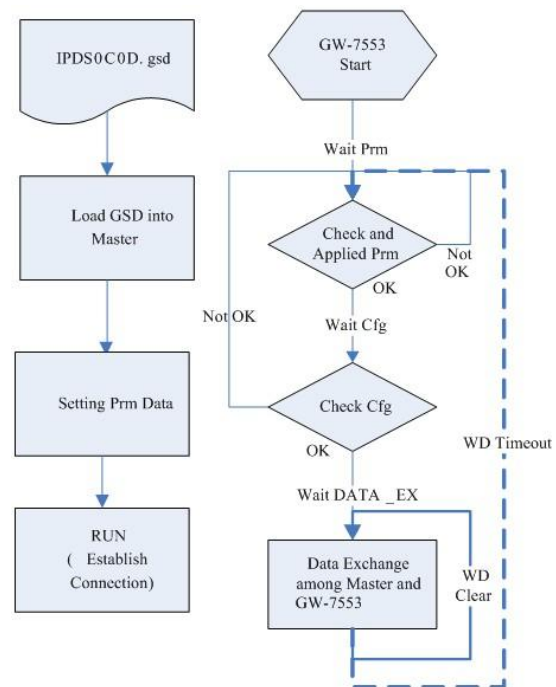

4. Software configuration

GSD file

Please copy the GSD file (IPDS0C0D.gsd) and the bitmap file (ICP_7553.bmp, GW_7553.bmp) from the CD of the GW-7553 module into the Profibus configuration tool.

File->CopyGSD

(Directory: --> CD:\profibus\gateway\gw-7553\gsd\)

➤ the example of how to load GSD file

Here, we use the hilscher CIF50-PB PROFIBUS communication interface to show how to load GW-7553's GSD file step by step.

Step 1: Click insert slave button in the PROFIBUS configuration tool.

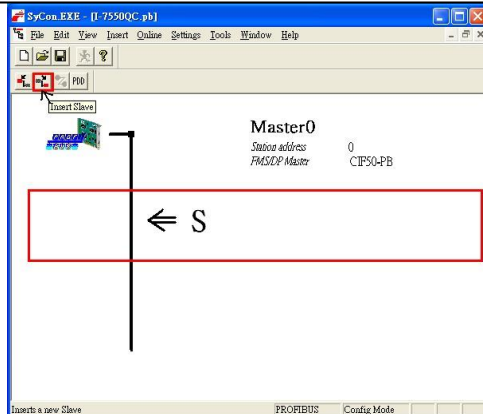

Step 2: Choose GW-7553 device and click Add button.

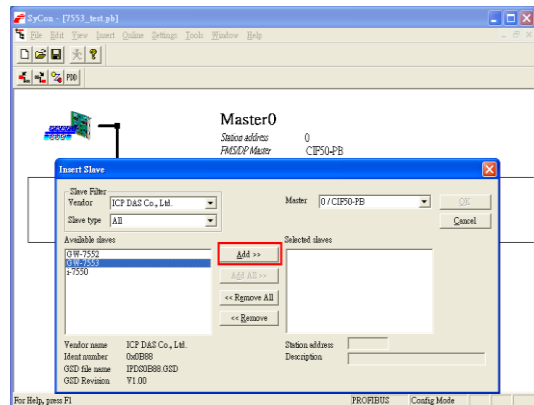

Step 3: Set address of GW-7553 and then click OK button.

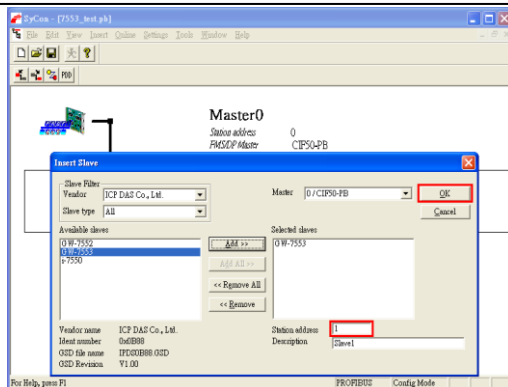

Step 4: Finish adding GW-7553 in the DP-master

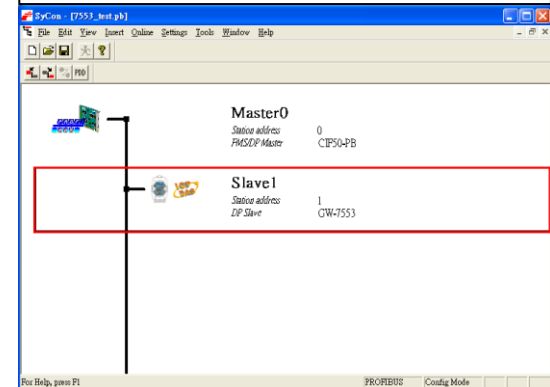

➤ **Set the parameters of the GW-7553**

The user needs to change “Modbus Type” to Slave, “Modbus Format” to Modbus TCP and use the default value in the other parameters in this example. Please refer to user manual section 4.3 The Configuration of the common parameters.

Double click the GW-7553's icon to enter the Slave configuration dialog

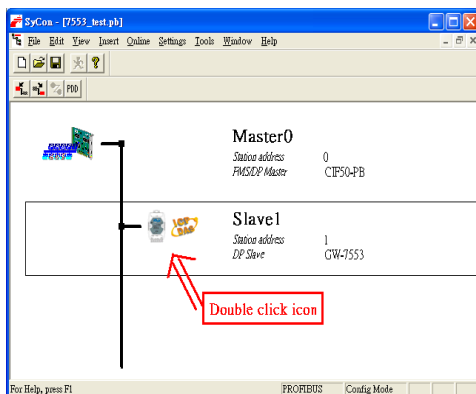

Click <Parameter Data> button to enter the Parameter Data dialog

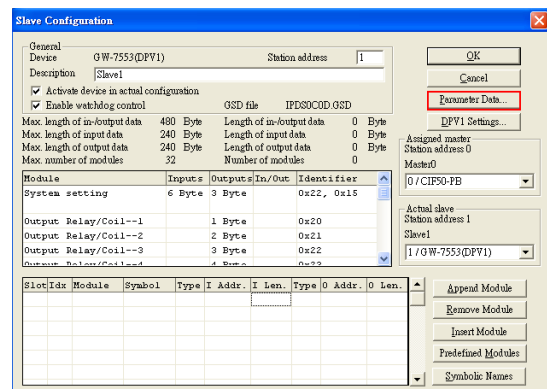

Change “Modbus Type” to Slave, “Modbus Format” to Modbus TCP and click <OK> button

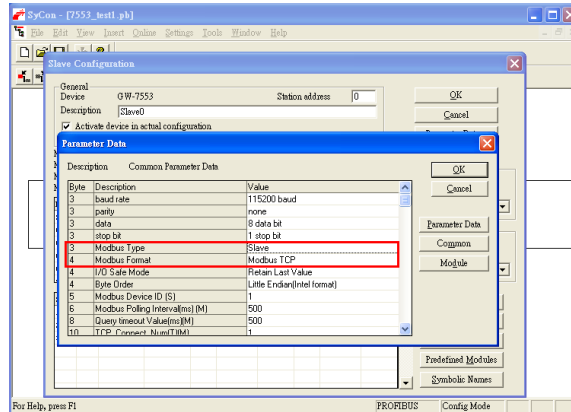

➤ **Set the modules of the GW-7553**

The modules of the GW-7553 are described below.

- System setting module : 3 byte output , 6 byte input
- Output module : Output Relay/Coil→ 1~32 Bytes
Output Register→ 1~64 Words
- Input module : Input Relay/Coil→ 1~32 Bytes
Input Register→ 1~64 Words

In this example, we configure a “System Setting” module, an “Output Relay/Coil--2 Byte” module and an “Input Relay/Coil--2 Byte” module, as follows.

Double click GW-7553’s icon to enter Slave configuration dialog

Configure module and click OK button

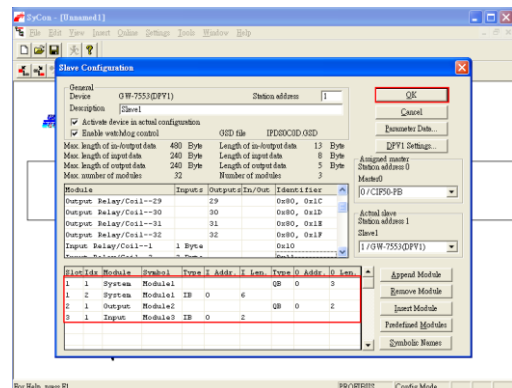
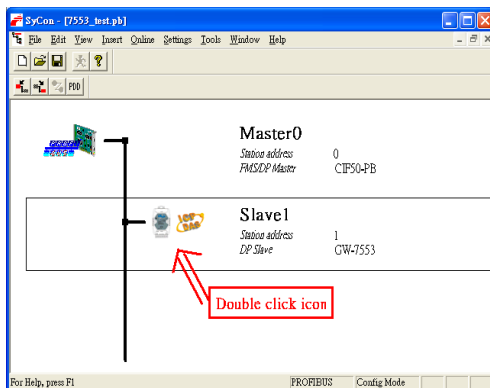

When the user finishes the configuration and saves setting in the PROFIBUS Master station successfully, the 'RUN' LED indicator of GW-7553 is turned on. That shows the GW-7553 working in the data exchange mode.

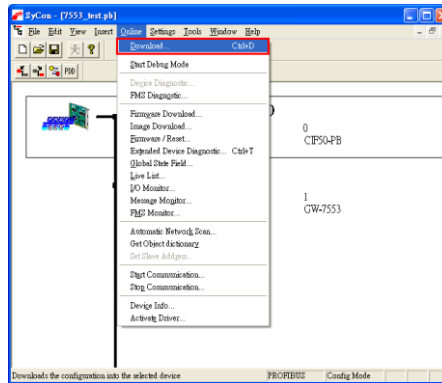

Click <Online->Download> to download the setting into PROFIBUS Master station

➤ **Set the network configuration of the GW-7553**

1. Open MiniOS7 utility and press “F12” to find IP address of GW-7553.
2. Open web browser (ex. IE). Enter IP address of the GW-7553 in the Address field and press “**Enter**” to connect to GW-7553, and then enter default password (“icpdas”) to login to GW-7553 in Login page.
3. Click “IP Setting” to set the network configuration of the GW-7553 (please refer to user manual section 6.2). The network configuration of the GW-7553 must have the same domain and different IP with the PC (ex: PC’s IP=192.168.0.106, MASK=255.255.0.0; GW-7553’s IP=192.168.0.107, MASK=255.255.0.0).
4. Press “Save to Device” to save IP setting to EEPROM of GW-7553 and restart GW-7553.

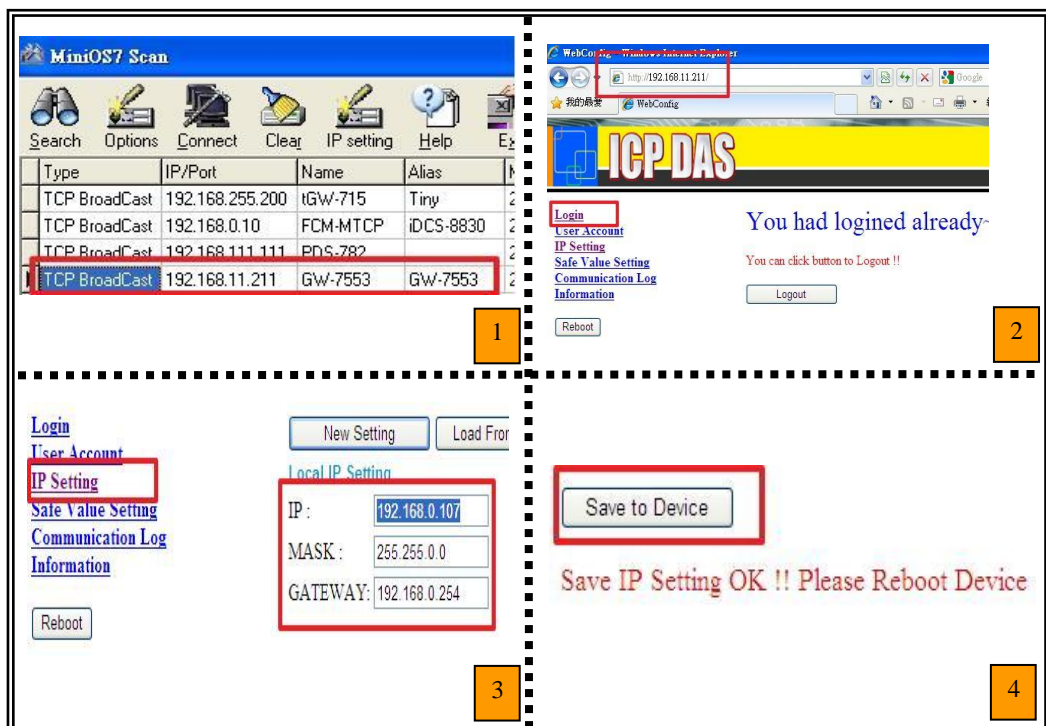

5. GW-7553 module communication test

This demo uses utility “MBTCP” on the PC to communicate with the GW-7553. The User can download it on the web site: http://ftp.icpdas.com.tw/pub/cd/8000cd/napdos/modbus/modbus_utility/. The settings of the “MBTCP” are shown in the below.

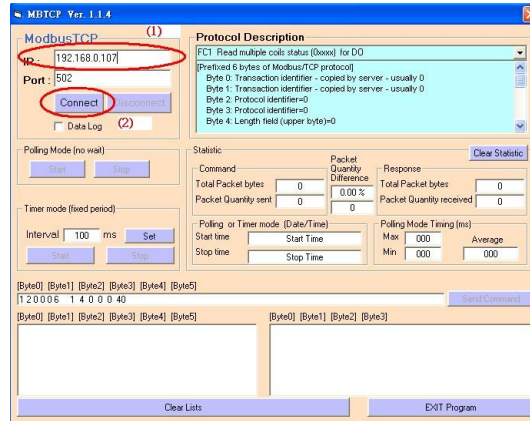

Input GW-7553’s IP (ex: 192.168.0.107) and click “Connect” button

➤ PROFIBUS input test

--Send command to write DO of the GW-7553

The user needs to input command (“01 0F 00 00 00 10 02 FF FF”) here and click <Send Command> button to send Modbus command and then MBTCP can receive response message (“01 0F 00 00 00 10”). The user can find byte 6, 7 of input data area of PROFIBUS Master device have changed into “0xFF” at this time, as shown in the below.

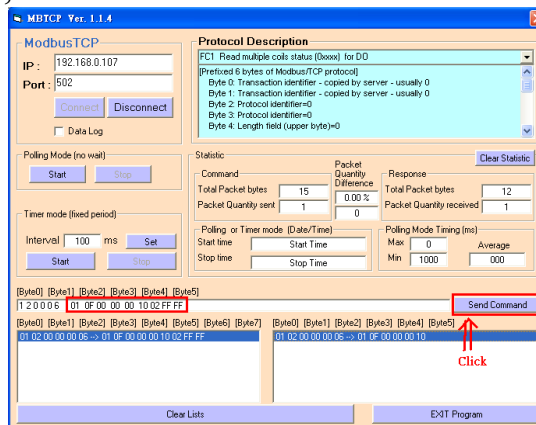

Send modbus command (output data: 0xFF, 0xFF)

Receive “0xFF” in input data area of PROFIBUS Master station

Module	Byte	Data type	Representation	Value
Input module	Input 6	Byte	Hex	0xFF
	Input 7	Byte	Hex	0xFF

➤ **PROFIBUS output test**

--Send Command to read DI of the GW-7553

The user needs to input command (" 01 02 00 00 00 10") in MBTCP and click <Send Command> button to send Modbus command and then MBTCP can receive response message (" 01 02 02 00 00"). In this message, the user can know the value of DI0 & DI1 is "0" in the GW-7553.

--Send output data to write DI of the GW-7553 by the PROFIBUS Master

The user needs to set "0xFE" & "0xDC" in byte 3 & byte 4 of output data area of PROFIBUS Master device and then set the value of the first byte from 0 to 1 to trigger the data output command.

--Send command to read DI of the GW-7553 again

Now the user can input command (" 01 02 00 00 00 10") in MBTCP and click <Send Command> button to send Modbus command again. Then MBTCP can receive response message (" 01 02 02 FE DC"). In this message, the user can know the value of DI0 & DI1 have changed into "0xFE" & "0xDC" in the GW-7553, as shown in the below.

Set output data and trigger output data command

<i>Module</i>	<i>Byte</i>	<i>Data type</i>	<i>Representation</i>	<i>Value</i>
System module	Output 0	Byte	Hex	0x00 → 0x01
	Output 1	Byte	Hex	0x00
	Output 2	Byte	Hex	0x00
Output module	Output 3	Byte	Hex	0x00 → 0xFE
	Output 4	Byte	Hex	0x00 → 0xDC

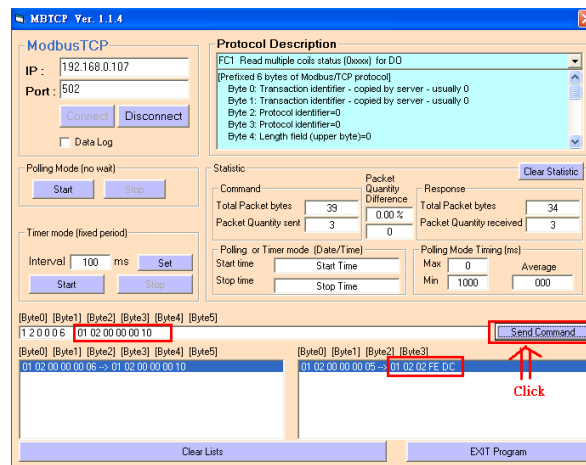

Send Modbus command to read DI of the GW-7553 and receive data (0xFE, 0xDC)