

---

# Quick Start Guide for I-7188XB

July 2012, Version 1.0

## Congratulations!

Congratulations on purchasing I-7188XB. This Quick Start Guide will provide information needed to get started. Please also consult the User Manual for detailed information on the setup and use of I-7188XB.

## What's In the Box?

In addition to this guide, the package includes the following items:



**I-7188XB**



**Software Utility CD**



**RS-232 Cable  
(CA-0910)**



**Screw  
(1C016)**

## Technical Support

- **7188XB\_Manual\_English.pdf/7188XB\_Manual\_Chinese.pdf**  
CD:\Napdos\7188XABC\7188XB\Document  
<http://ftp.icpdas.com/pub/cd/8000cd/napdos/7188xabc/7188xb/document/>
- **I-7188XB Website**  
[http://www.icpdas.com/products/PAC/i-7188\\_7186/i-7188xb.htm](http://www.icpdas.com/products/PAC/i-7188_7186/i-7188xb.htm)
- **ICP DAS Website**  
<http://www.icpdas.com/>

# 1

## Software Installation

Step 1: Insert the companion CD into the CD drive.

Step 2: Copy the 7188XB folder from **CD:\Napdos\7188XABC\** to the Hard Drive of the Host PC.

Step 3: Install the MiniOS7 Utility.

Locate and execute the **minios7\_utility\_vXXX.exe** file from CD:\NAPDOS\MINIOS7\UTILITY\MiniOS7\_utility\ folder or [http://ftp.icpdas.com/pub/cd/8000cd/napdos/minios7/utility/minios7\\_utility/](http://ftp.icpdas.com/pub/cd/8000cd/napdos/minios7/utility/minios7_utility/)

Step 4: Copy the **7188xw.exe** file from the CD:\Napdos\MiniOS7\utility\ folder to the PATH directory, for example **C:\Windows\**.

After all the software is copied to the Host PC, the content of 7188XB folder should be as follows:

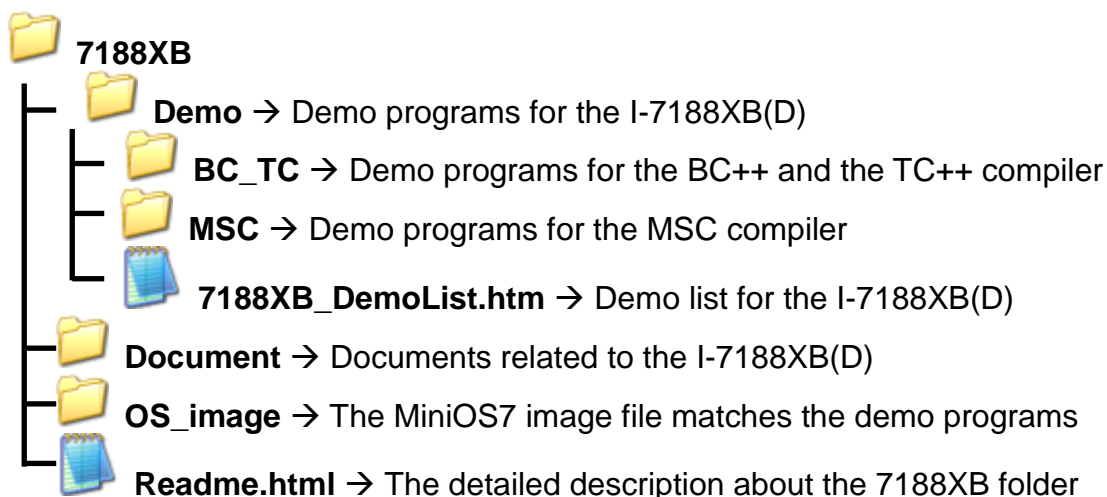

**Note:** The 7188xw.exe file is used as a bridge between the I-7188XB(D) and the Host PC. Therefore, the 7188xw.exe file must be copied to the “C:\Windows\” folder to allow it to be executed from any location.

# 2

## Connecting the Download Cable to the Host PC

Step 1: Connect the CA0910 download cable between COM1 of the I-7188XB(D) and the COM Port of the Host PC, as shown in the diagram below.

Step 2: Apply power (Vs+, GND) to the I-7188XB(D). Vs+ can be in a range from +10V to +30V DC.

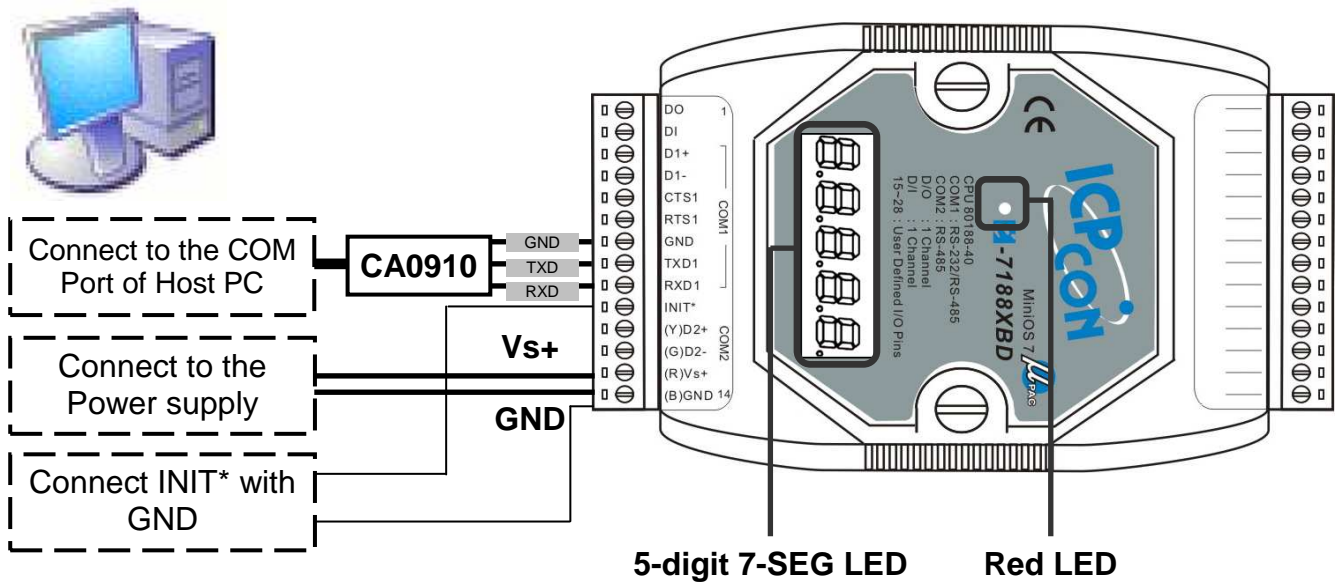

Step 3: After applying the power, the 5-digits of the 7-SEG LED will continuously show as follows.

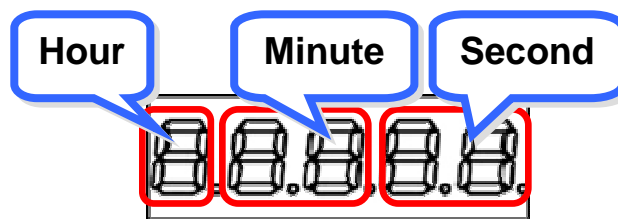

If the non-display version of module is being used, please continue to the next step.

Step 4: Check that the red LED continuously blinks one times and wait for one second to next cycle. The diagram show as follows:

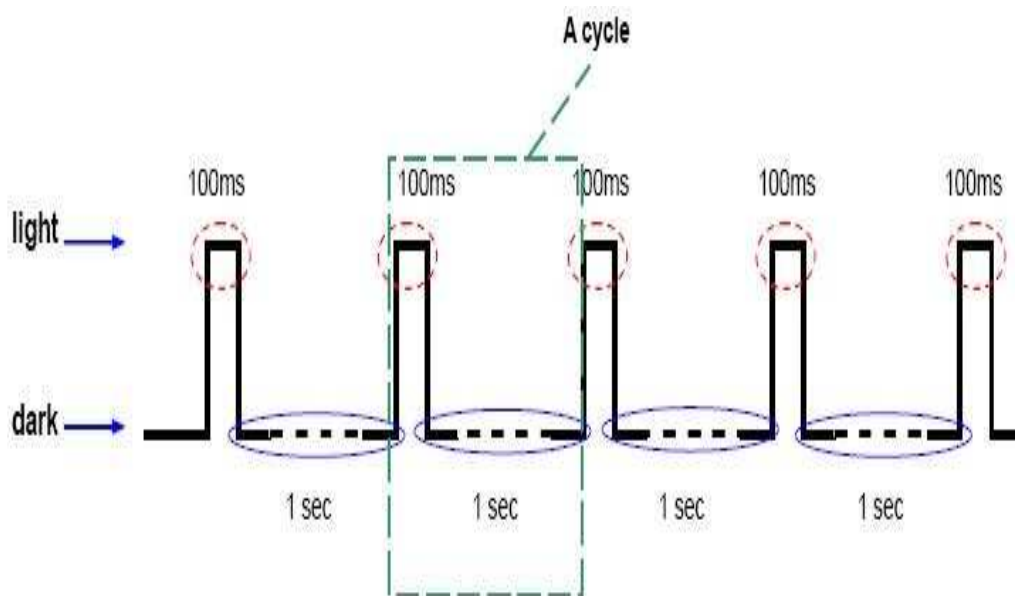

**Note:** Only the display version of the module will include a 5-digit 7-SEG LED.

# 3 Downloading Programs to the I-7188XB(D)

Before using the MiniOS7 Utility, ensure that the download cable is connected from the Host PC to the I-7188XB(D) and ensure that no other programs are running on the I-7188XB(D).



The program download procedure is as follows:

Step 1: From the Windows START menu, go to Programs/ICPDAS/MiniOS7 Utility Ver XXX/and locate the **MiniOS7 Utility Ver XXX**.

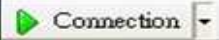

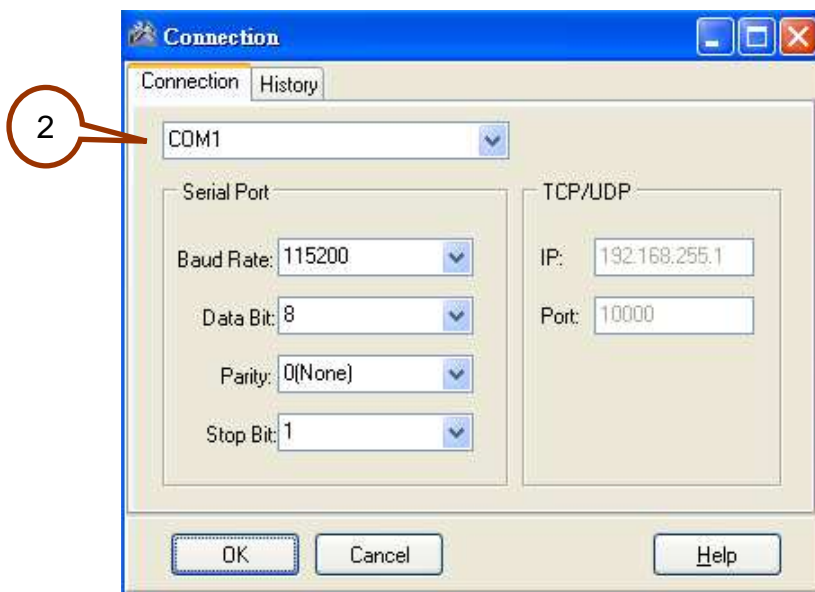
Step 2: Press  and Select "New connection". Choose the right COM port and set other parameters. Click **OK** button and the utility will search module automatically.



Step 3: See if the MiniOS7 Utility connects with I-7188XB. The connected icon is . The disconnected icon is .

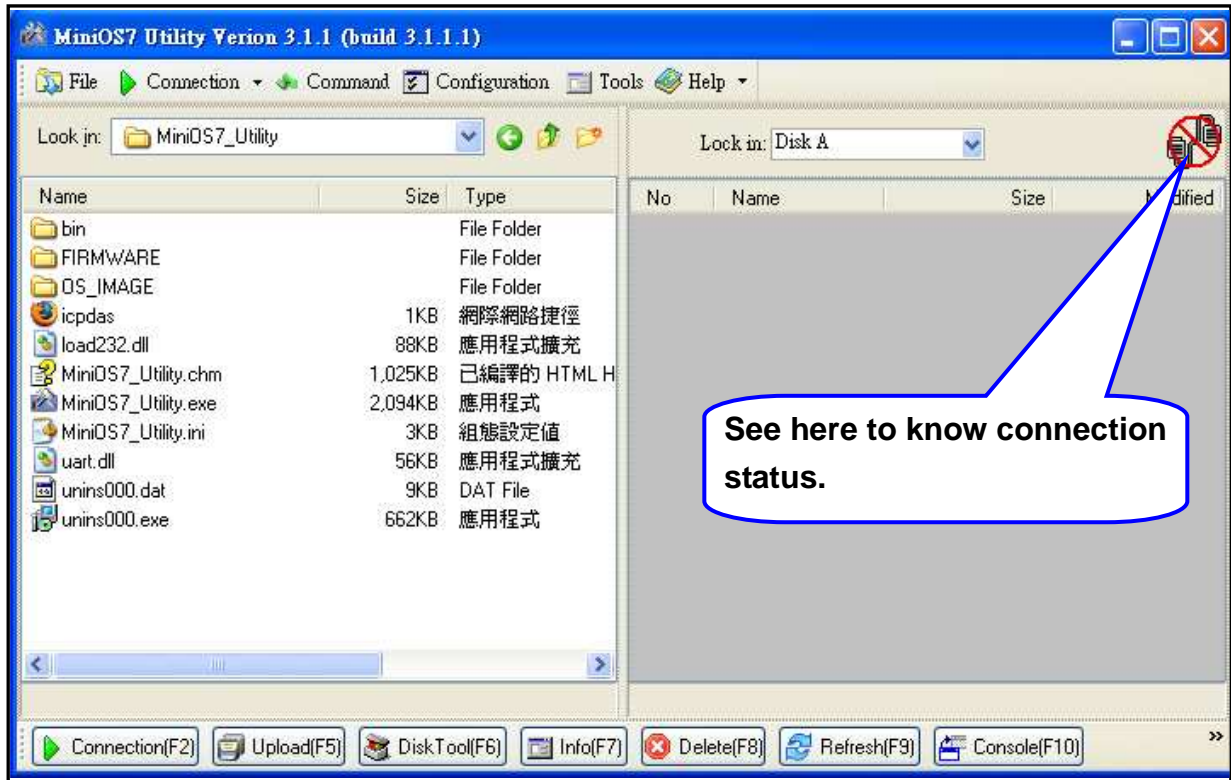

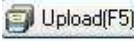
Step 4: Select the file to load from left side and click  to load file into module or draw the file to the right side.

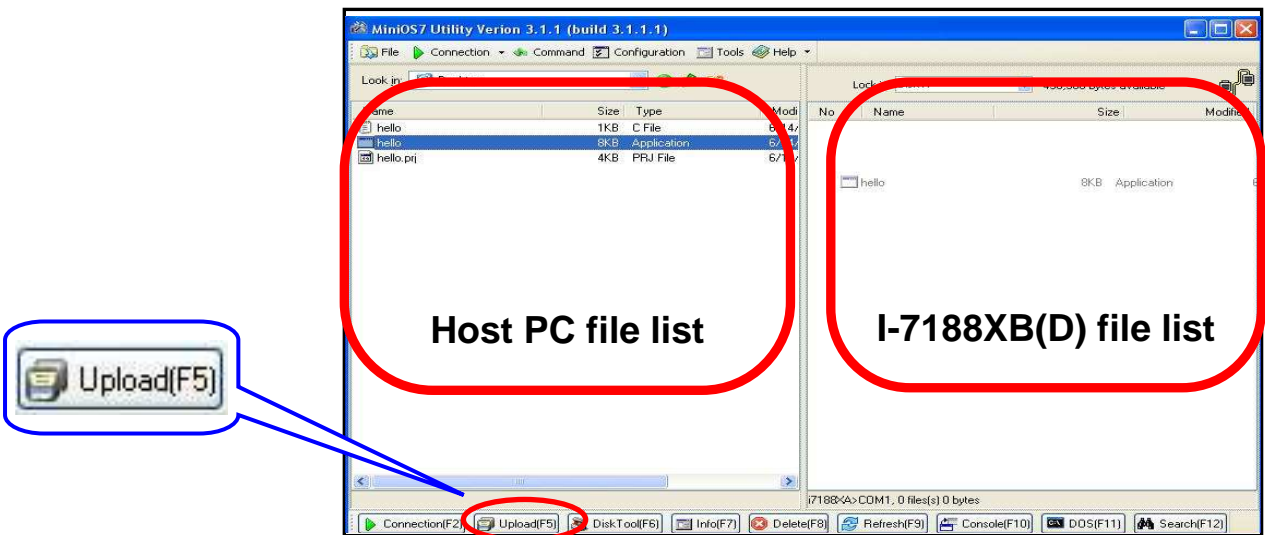



Step 5: Select the file and then press the right mouse button. Choose the **Run** and press to execute the program.

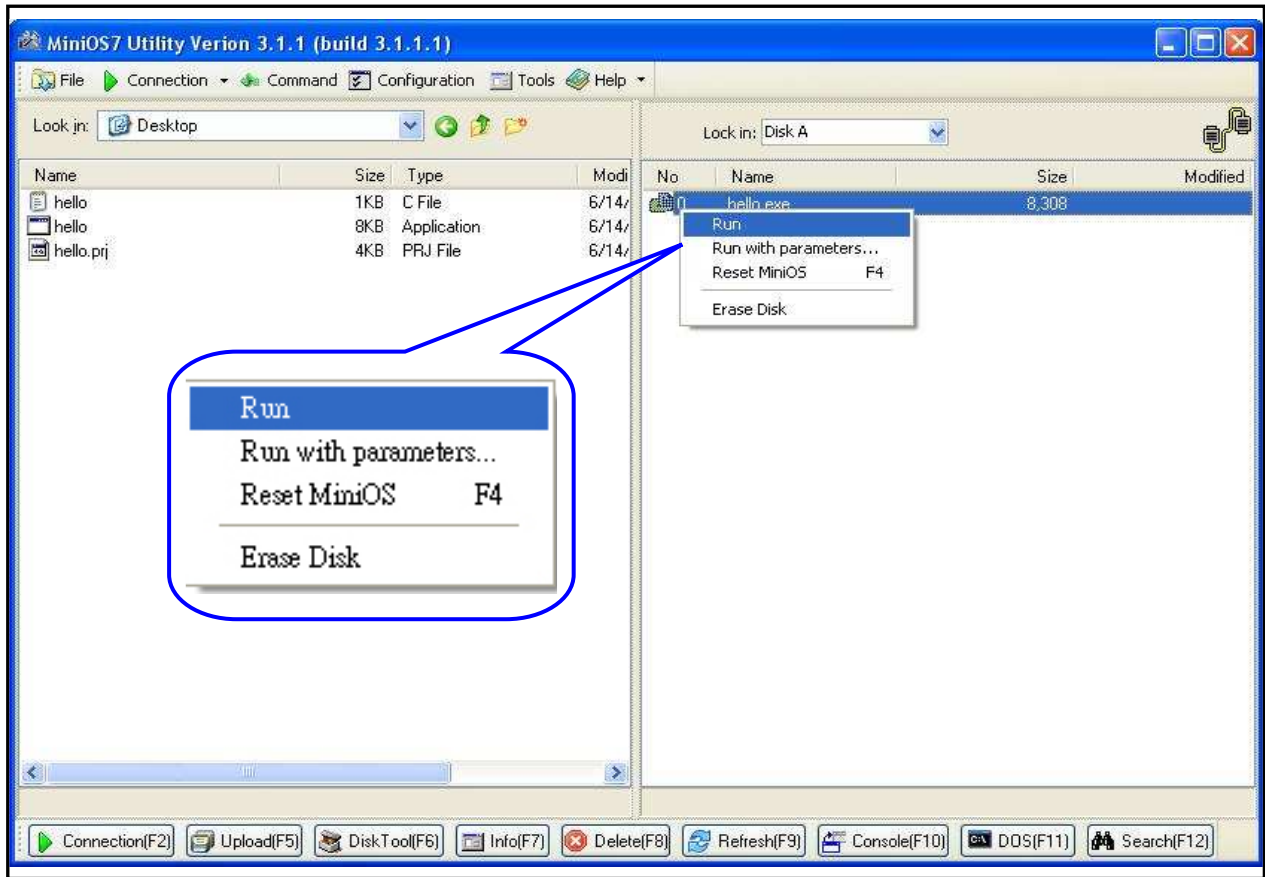

Step 6: The result of the program will be shown in 7188xw window.

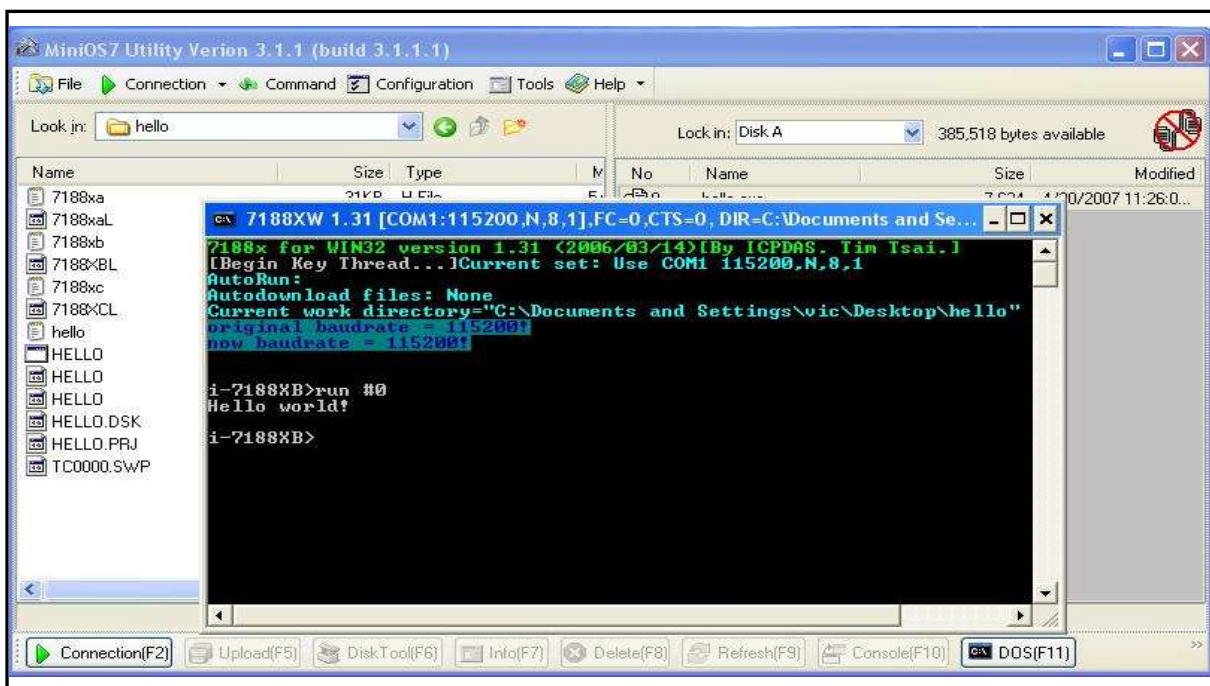

NOTE: The 7188xw window has to be closed and then the download operation (Step 4) could be done.

The content of the Hello.c file is as follow:

```
#include "7188xb.h"    /* Include the headers to use 7188xb.lib  
                        functions */  
  
void main(void)  
{  
    InitLib();          /* Initiate the 7188xb library */  
  
    Print("Hello world!\r\n"); /* Print the message on the screen */  
    ,
```