

---

# I-7530A-MR

Modbus RTU to CAN Converter

## Quick Start

---

### Package checklist:

The package includes the following items:

- One I-7530A-MR hardware module
- One Quick Start Guide
- One software utility CD
- One screw driver
- One RS-232 cable (CA-0910)



### Note:

If any of these items are missed or damaged, contact the local distributors for more information. Save the shipping materials and cartons in case you want to ship in the future.

---

## 1. Introduction

This manual introduces the user to the methods used to implement the I-7530A-MR module into their applications in a quick and easy way. This only provides with the basic instructions. For more detailed information, please refer to the I-7530A-MR user manual located on the ICP DAS CD-ROM or download it from the ICP DAS web site:

[Fieldbus\\_CD:\CAN\Converter\I-7530A-MR>manual](Fieldbus_CD:\CAN\Converter\I-7530A-MR>manual)

[http://www.icpdas.com/products/Remote\\_IO/can\\_bus/i-7530A-MR.htm](http://www.icpdas.com/products/Remote_IO/can_bus/i-7530A-MR.htm)

The goal of this manual is focused on helping users to quickly familiarize themselves with the I-7530A-MR module and the data-exchanged between RS-232/485/422 and CAN communication interfaces. Here, we use two I-7530A-MR modules (called the I-7530A-MR\_A and the I-7530A-MR\_B) as the example to demonstrate how to use the I-7530A-MR modules. The architecture of this example is depicted below.

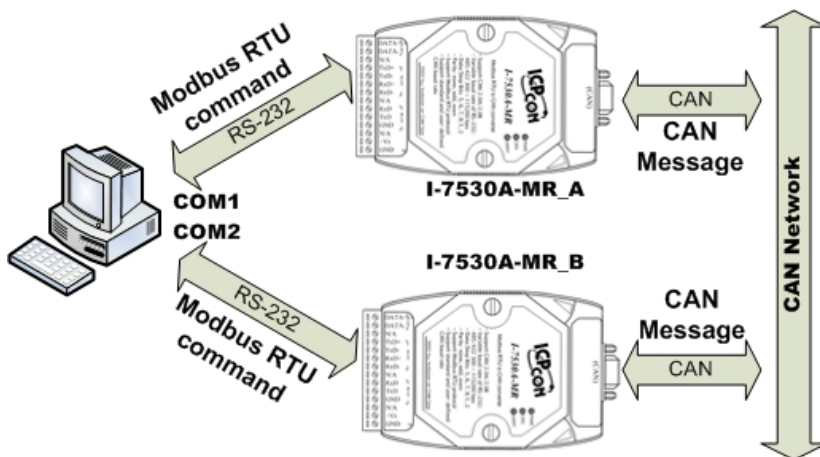

When the I-7530A-MR receives a valid Modbus RTU command, it converts this command into a CAN message and transmits it into the CAN network. Based on the same reasoning, when a CAN message is received via the I-7530A-MR, the message will be stored in the I-7530A-MR until being obtained by the Modbus RTU master.

## 2. Hardware Installation

Users need to make a hardware connection between the two I-7530A-MR modules before the application. The details of this are illustrated below:

Step1: Set-up the 120Ω terminator resistor of the module A and B.

Before you continue, if you have changed the settings from default then it is necessary to open the cover for each I-7530A-MR and re-configure their JP3 jumpers to enable them again, as shown in below figure. However if the I-7530A-MR's still have their default settings then it is not necessary to open and reset them because the default configuration is enabled.

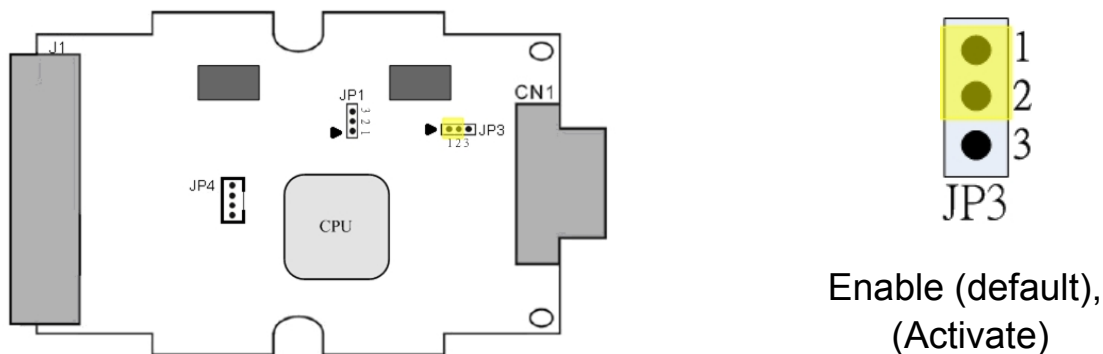

**Step2: Power connection for the I-7530A-MR\_A and B.**

Connect the +Vs and GND pins of the I-7530A-MR module to the DC power supply (10~30V<sub>DC</sub>).

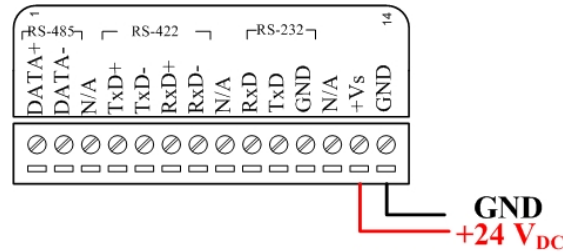

**Step3: RS-232 connection**

Connect the RS-232 ports of the I-7530A-MR\_A and I-7530A-MR\_B to the RS-232 COM1 and COM2 of the PC by using the attached cable CA-0910 respectively. You can use the attached cable CA-0910 to do that.

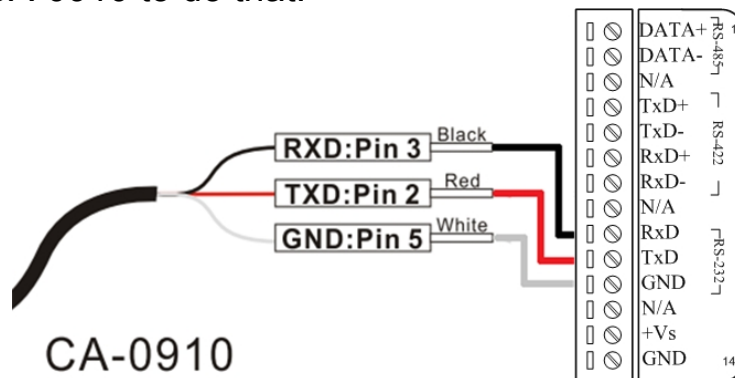

**Step4: CAN bus connection**

Connect the CAN ports of these two I-7530A-MR modules using the following architecture. If necessary, you may refer the cable CA-0910-C for wiring conveniently. Please refer to the following picture.

[http://www.icpdas.com/products/Accessories/cable/cable\\_selection.htm](http://www.icpdas.com/products/Accessories/cable/cable_selection.htm)

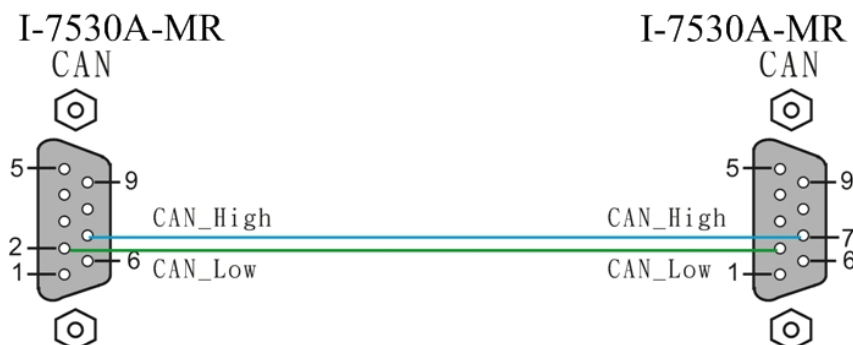

### 3. I-7530A-MR Parameter Configuration

Before starting the I-7530A-MR converter tests, users need to configure the RS-232/485/422, Modbus and CAN parameters via the UART2CAN Utility tool. The details of this procedure are shown below.

Step1: Turn off the DC power connected with these two I-7530A-MR modules.

Step2: Set the Init/Normal switches on the back of the I-7530A-MR\_A to the “Normal” position. Then, turn on the DC power. Afterwards, set the Init/Normal switches to the “Init” position and hold it at least 3 seconds. The CAN LED and UART LED of the I-7530A-MR\_A will flash approximately once per second. That means that the I-7530A-MR is working in the configuration mode.

Step3: Run the UART2CAN Utility. The “UART2CAN Utility.exe” is located on the fieldbus\_cd\can\converter\I-7530A-MR\utility folder on the product CD-ROM or is downloaded from the web site:

[http://ftp.icpdas.com/pub/cd/fieldbus\\_cd/can/converter/i-7530a-mr/utility/](http://ftp.icpdas.com/pub/cd/fieldbus_cd/can/converter/i-7530a-mr/utility/)

Step4: Select the proper PC COM port No., baud rate and data format, which are used to be communicated with the I-7530A-MR\_A. When the Utility starts, the following dialog will be popped up. The default setting of the PC COM port field is configured at 115200bps, 8 Data Bits, 1 Stop bit, and no parity.

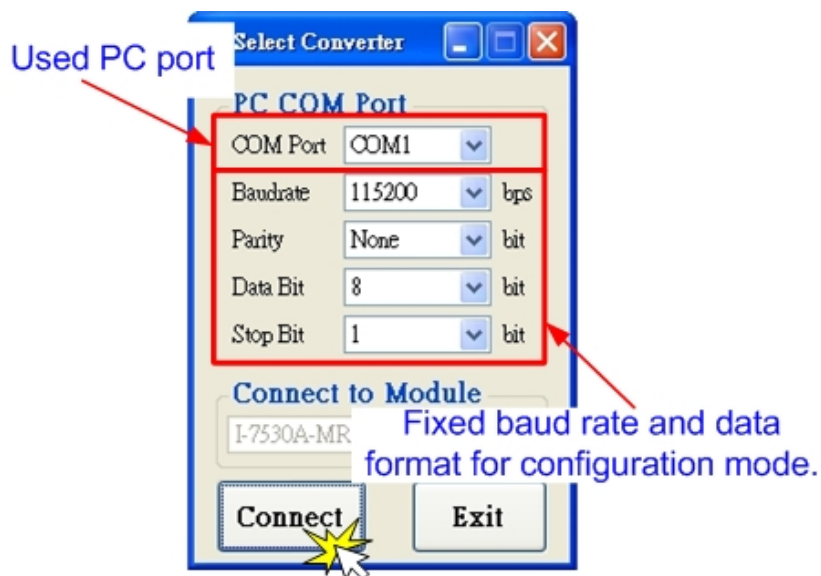

Step5: Click the “Connect” button. If the connection is successful, the UART2CAN Utility will show the communication information of the I-7530A-MR\_A module, as shown in the following figure.

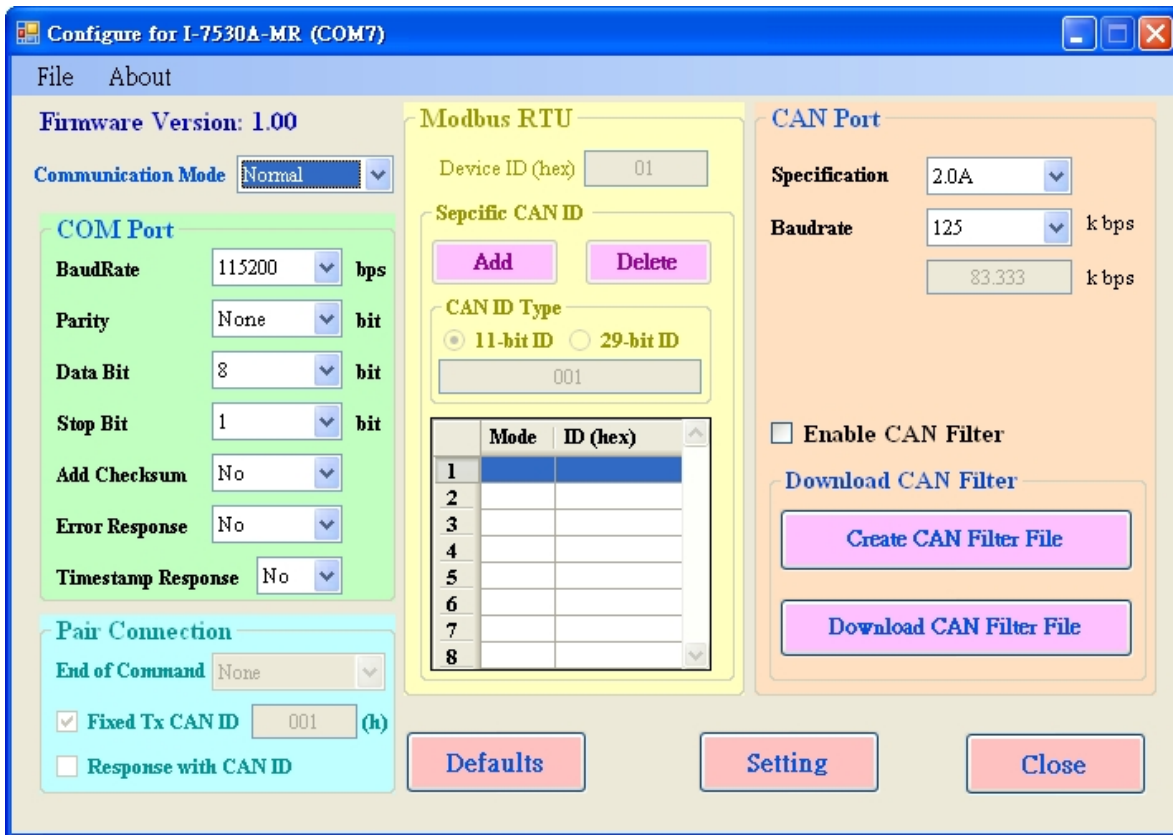

Step6: Set the communication mode of the I-7530A-MR\_A. Here, use Modbus TRU mode for example.

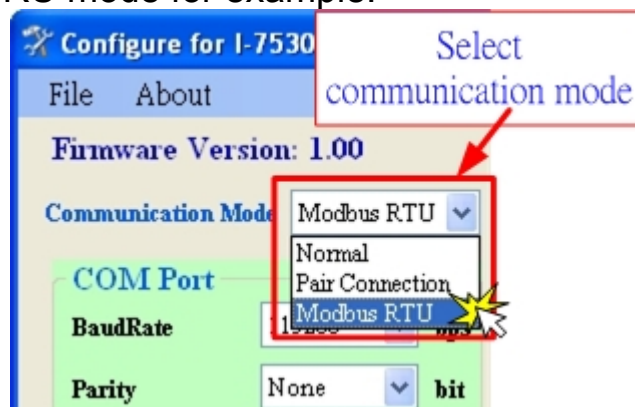

Step7: In order to match the RS-232 parameters of the PC COM port, please configure the COM parameters of the I-7530A-MR\_A as follows:

---

**Baud rate** : 115200bps  
**Data bits** : 8  
**Stop bits** : 1  
**Parity** : None  
**Checksum** : No

Step8: Set the CAN baud rate of the I-7530A-MR\_A. Here, use 125 kbps for CAN baud, and uncheck the “Enable CAN Filter” item (For more information about CAN Filter configuration, please refer to the section 3.4 of the user manual).

Step9: Set the Device ID of the I-7530A-MR\_A and I-7530A-MR\_B as 1 and 2 respectively. Here the “Specific CAN ID” field does not be used (For more information about Modbus RTU configuration, please refer to the section 5 of the user manual)

Step10: Click the “Setting” button to save these CAN/COM parameters into the EEPROM of the I-7530A-MR\_A.

Step11: Repeat Step 1 ~ Step 9 to configure the I-7530A-MR\_B converter with the same configurations as the I-7530A-MR\_A.

## 4. Testing the I-7530A-MRs

Step1: Turn off the DC power connected with these two I-7530A-MR modules.

Step2: Set the Init/Normal switches on the back of the I-7530A-MR A and I-7530A-MR\_B to the “Normal” position. Then, turn on the DC power. The CAN LED and UART LED of the I-7530A-MR\_A and B will be turned off. It means these two I-7530A-MR converters are working in the operation mode.

Step3: Run the UART2CAN Utility twice. Then duplicate I-7530A-MR Utility dialogs will be displayed on the PC’s screen. Assume that one is named as Utility\_A and the other is Utility\_B.

Step4: Select the proper COM port parameters and configure the RS-232 COM1 and the RS-232 COM2 of the PC. The COM1 and COM2 ports of the PC will be used for connecting with the I-7530A-MR\_A and I-7530A-MR\_B respectively. Then change the communication mode of Utility\_A and Utility\_B to Modbus RTU mode. The two Utility dialogs are similar with the following picture.

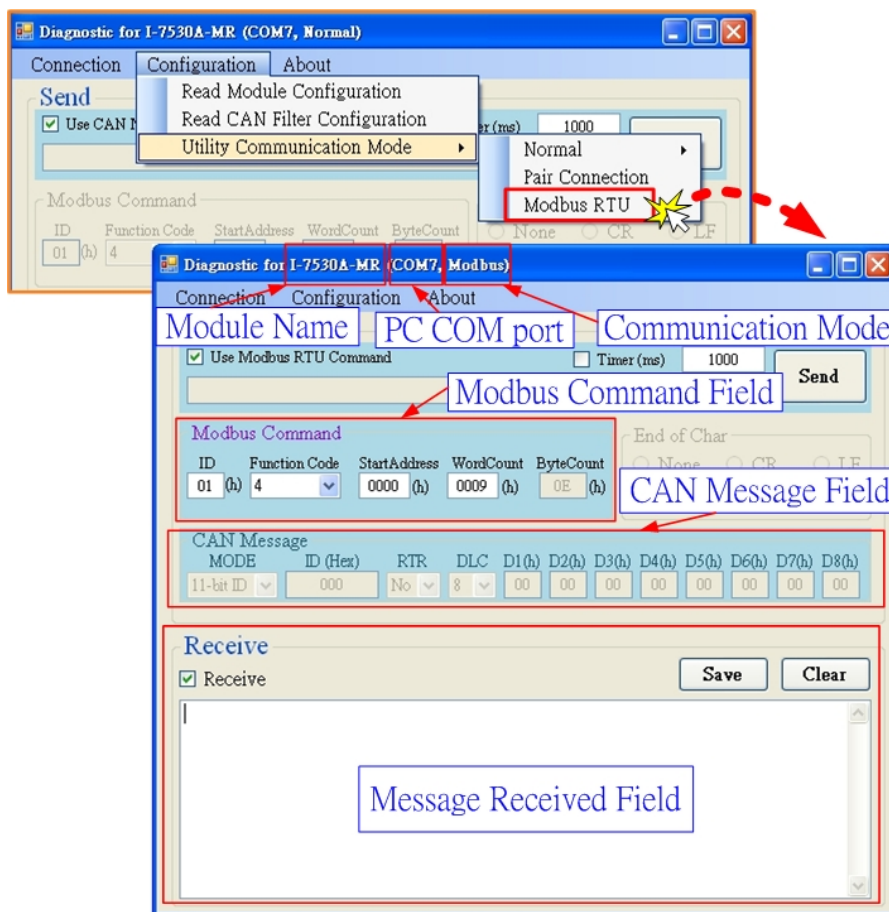

Step5: Check the “Use Modbus RTU Command” checkbox and key-in the correct data in the “Modbus Command” and “CAN Message” fields of the Utility\_A. Click the “Send” button. Then, the Utility\_A will automatically transfer this CAN message to the Modbus RTU command and send it out through the PC RS-232 COM1 port. After the I-7530A-MR\_A receives this command, it will convert the Modbus RTU message to the CAN message, and send it to the CAN network. While the I-7530A-MR\_B receives the CAN message transmitted from I-7530A-MR\_A. The message will be converted and stored in the I-7530A-MR\_B until being obtained by the Modbus RTU master. Then, use the Modbus RTU command (function code 04<sub>hex</sub>) to get the CAN message by the Utility\_B. Detailed steps of this are shown in the following figure.

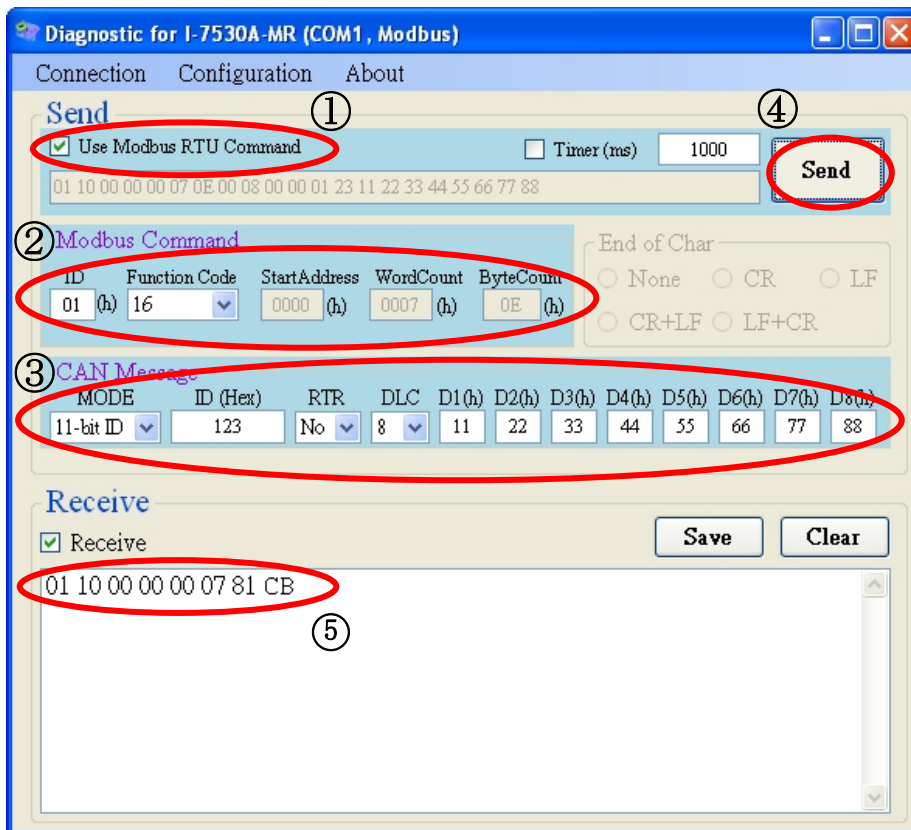

Utility A

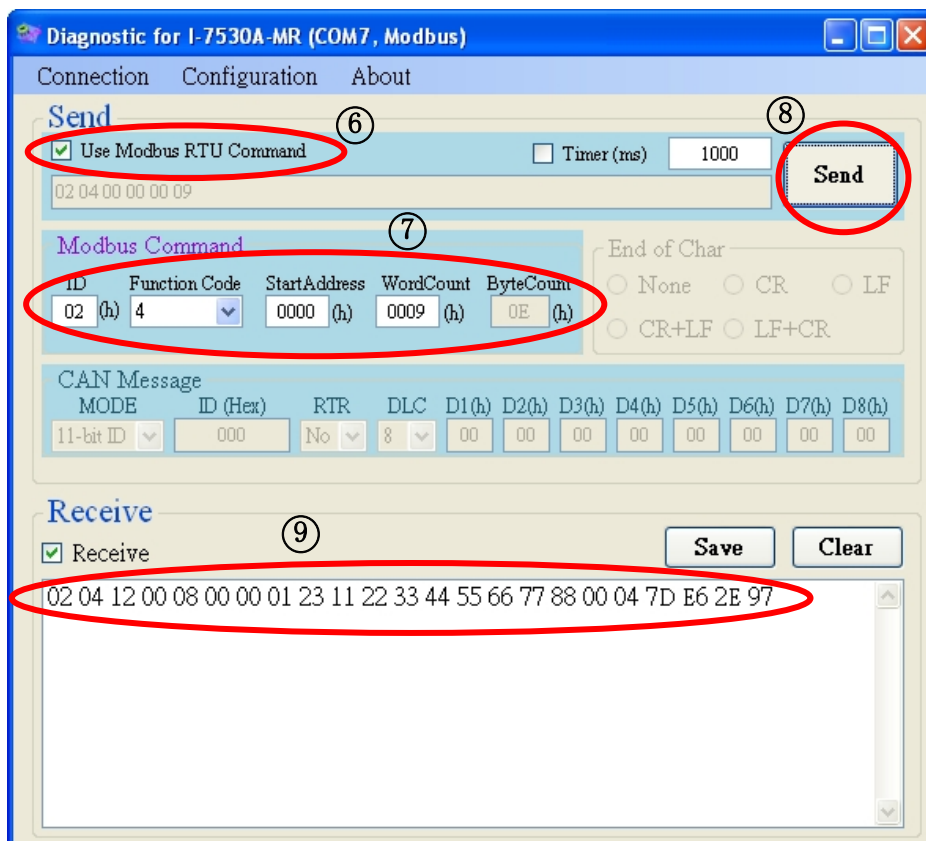

Utility B