

# I-87123

## Quick Start User Guide

### 1. Introduction

This user guide introduces how to apply the I-87123 into users' application quickly and easily. Therefore, it only provides the basic instructions. For more detail about the driver, please refer to the I-87123 user manual in the product CD or the website:

CD path: [\CANopen\master\I-87123\](#)

Website: [http://www.icpdas.com/products/Remote\\_IO/can\\_bus/i-87123.htm](http://www.icpdas.com/products/Remote_IO/can_bus/i-87123.htm)

### 2. Software Structure

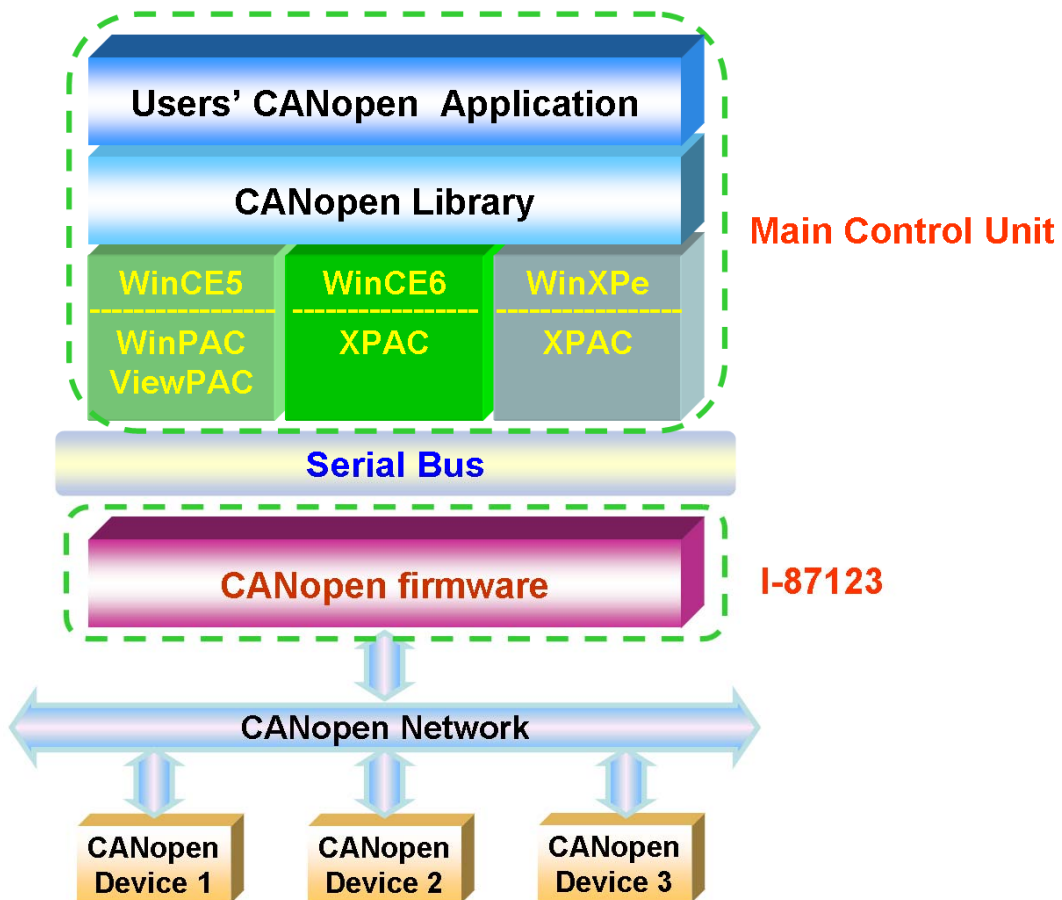







### 3. Hardware Structure

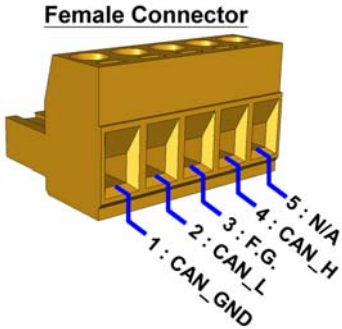
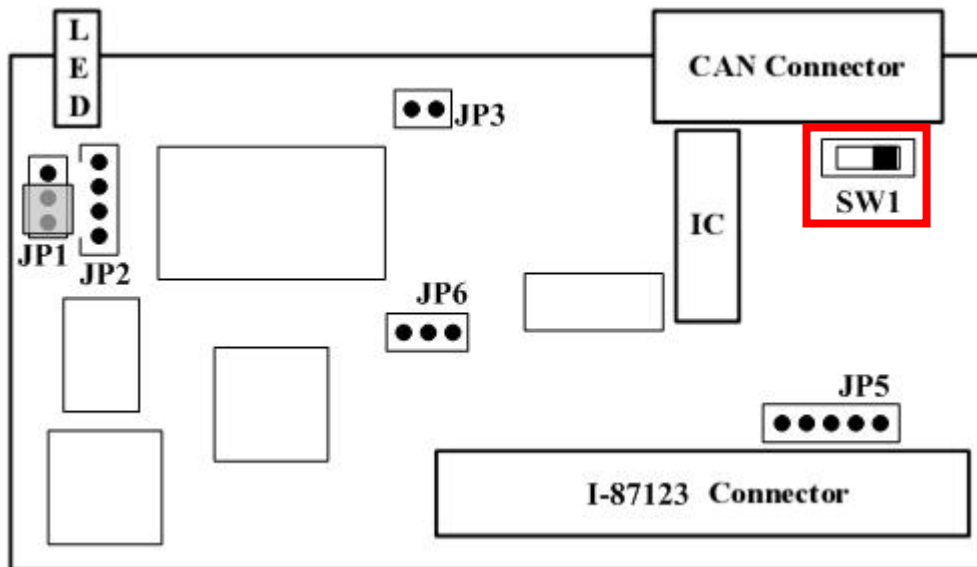

LED	Color	Description
PWR	Red	Turn on when I-87123 power on.
Tx/Rx	Green	When the I-87123 is transmitting or receiving a CAN message, the Tx/Rx LED will blink. If I-87123's loading is heavy, the Tx/Rx LED will always turn on
ERR	Orange	The ERR LED indicates the error status of the CAN physical layer and indicates the errors due to missing CAN message.

Pin	Signal	Description
1	GND	Ground
2	CAN_L	CAN_L bus line
3	F.G.	CAN Shield
4	CAN_H	CAN_H bus line
5	N/A	Non-available

Jumper	Description	Status	
SW1	120Ω terminator resistance of CAN port.	 Enable	 Disable
JP1	Lock mode for resisting the noise or disturbances. In this case, updating firmware is not allowed. Unlock mode for updating the firmware of the I-87123.	 Lock	 Unlock
JP3	Initial Pin, short it and power on the I-87123, I-87123 will into OS mode for update firmware	 UnShort	 Short

## 4. Getting Start

Before following the steps below, users need to prepare some hardware, an I-87123, a CANopen slave device and a ViewPAC-2xWx, WinPAC-8000, XPAC-8000 or XPAC-8000-CE6 series MCU.

Step 1: Set the SW1 of the I-87123 to the proper position. Generally, the both ends of CAN bus (line topology) need 2 terminator resistances. Each of them is 120Ω.

Step 2: Put the I-87123 in slot 0 of WinPAC series MCU and connect the CAN port of the I-87123 with the CAN port of a CANopen slave device as following figure. Then power on these hardware.

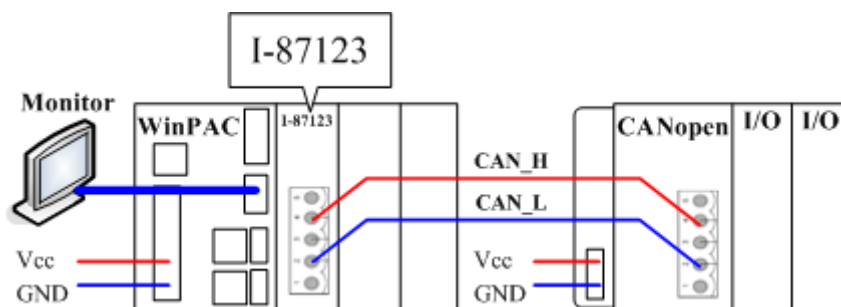

Step 3: Download the I87123.dll into the WinPAC. Then select a demo execute file and download it into the same folder. **Take a note that if you select a C#.net demo or a VB.net demo, the I87123W\_Net.dll also needs to be downloaded into the same folder.** (About how to download file to WinPAC, please refer to the WinPAC user manual)

---

The paths for these files are as follows:

**CD path:**

I87123.dll:  
<CANopen/Master/I-87123/Drivers/CE5/>

Demos:  
<CANopen/Master/I-87123/Demos/CE5/>

**FTP path:**

I87123.dll:  
[ftp://ftp.icpdas.com/pub/cd/fieldbus\\_cd/canopen/master/i-87123/drivers/ce5/](ftp://ftp.icpdas.com/pub/cd/fieldbus_cd/canopen/master/i-87123/drivers/ce5/)

Demos:  
[ftp://ftp.icpdas.com/pub/cd/fieldbus\\_cd/canopen/master/i-87123/demos/ce5/](ftp://ftp.icpdas.com/pub/cd/fieldbus_cd/canopen/master/i-87123/demos/ce5/)

**WinPAC User manual web site:**

[http://www.icpdas.com/products/PAC/winpac/download/winpac\\_8000/download\\_documents.htm](http://www.icpdas.com/products/PAC/winpac/download/winpac_8000/download_documents.htm)

Step 4: Take an example, download the SDO\_Read demo and relative files into the folder of the WinPAC.

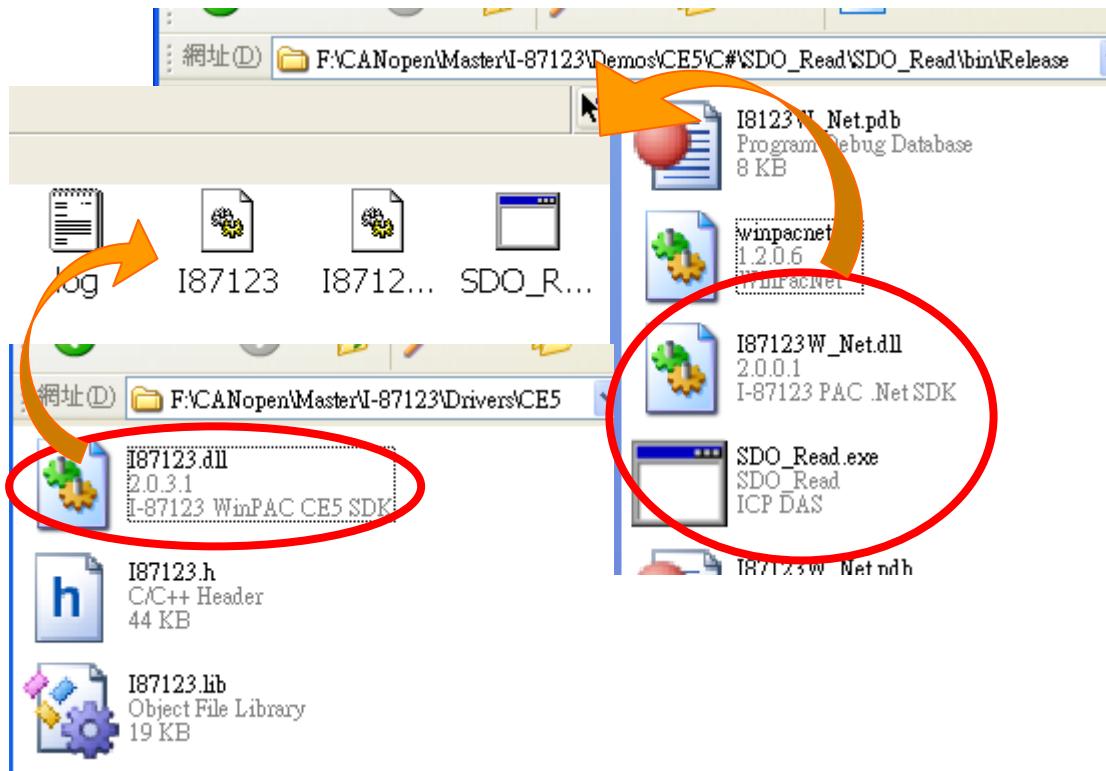

Step 5: Run the demo on the WinPAC. The following dialog is popped up.



Step 6: Assume the I-87123 is plugged in slot 0 of the WinPAC, and the baud of the CANopen network is 1000 kbps, set the "Slot No." and "Baud Rate" as following figure. Then click "Initial Master" to initialize the I-87123.

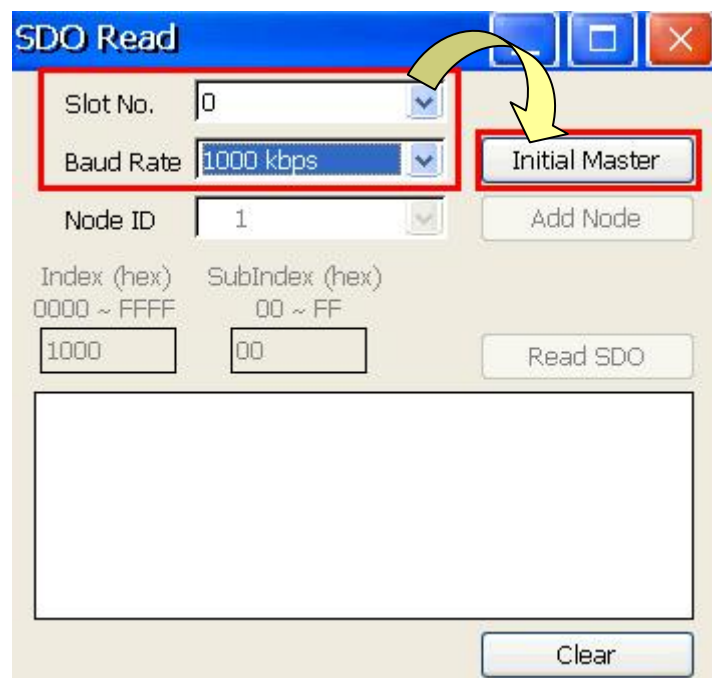

Step 7: Assume there is a CANopen slave with node ID 1 on the CANopen network. Select the "Node ID" 1 and click "Add Node" to add this

---

CANopen slave into the I-87123 node list.

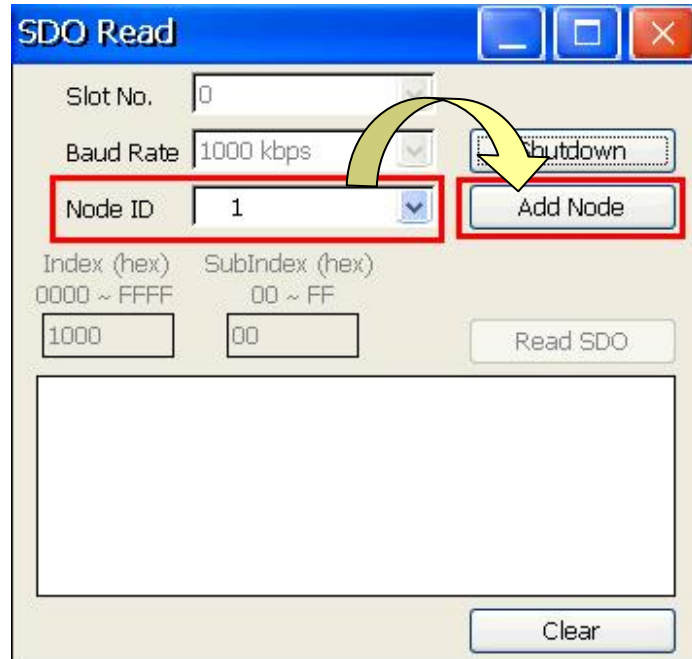

Step 8: After adding the node successfully, you can enter the index and sub-index of the CANopen object in the slave object dictionary, and click "Read SDO" button to read the SDO data from the CANopen slave. The response data will be shown on the list.



Step 9: You can follow the step 4 to download the SDO Write demo for other

tests. According to the step 5 ~ step 7, select the "Node ID" 1 and click "Add Node" to add it into the I-87123.

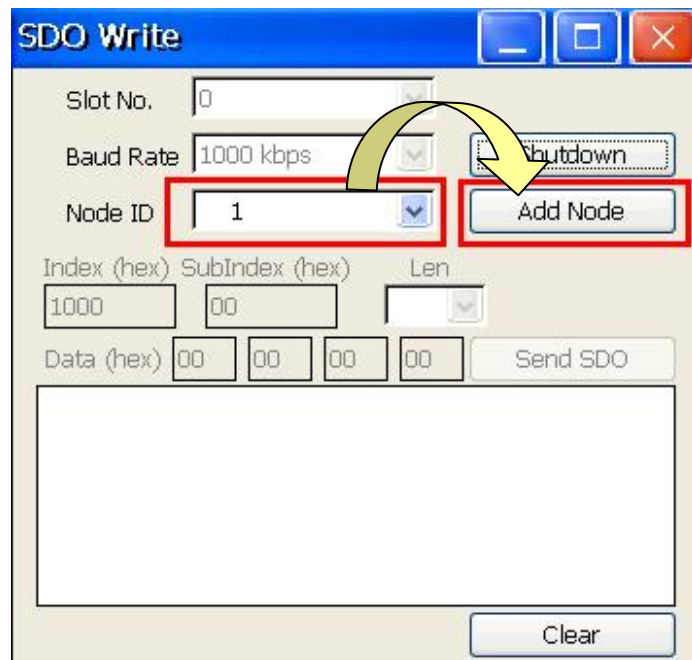

Step 10: After adding node successfully, you can enter the index and sub-index of the object in the slave object dictionary. Then set the data length and the data that want to be written in this object. Click "Send SDO" button to write the SDO data to the CANopen slave. If false, the response of the abort message will be shown on the list.

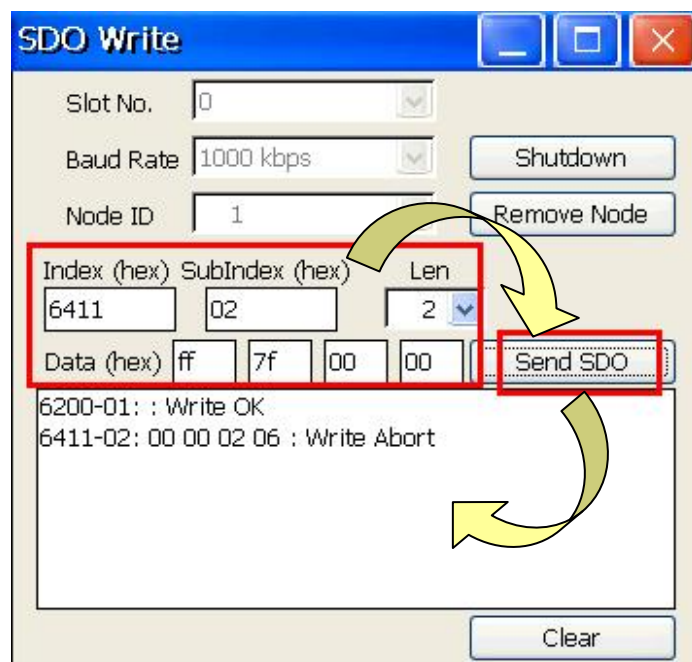

---

## 5. Directory Tree

The paths for all I-87123 files are as follows:

**CD path:**

[CANopen/Master/I-87123/](#)

**FTP path:**

[http://ftp.icpdas.com/pub/cd/fieldbus\\_cd/canopen/master/i-87123/](http://ftp.icpdas.com/pub/cd/fieldbus_cd/canopen/master/i-87123/)

