

Quick Start for LP-8x4x

Version 1.6, 2013/06/06

➔ What's In the Box?



LP-8x4x module

LP-814x: 1 slot
LP-844x: 4 slots
LP-884x: 8 slots

microSD card

CD

Screw Driver

(1C016)
2.4mm

RS-232 Cable

CA-0910
CA-0915
CA-0915

In addition to this manual, the package includes the following items:

- One set of LP-8x4x hardware
- One microSD card for storing system files
- One quick start guide (this manual)
- One software utility CD with Software User's Manual included
- One screw driver (2.4 mm)
- RS-232 cable

Table of Contents

1. INTRODUCTION	3
2. FRONT VIEW	4
3. OPERATION MODES	5
4. PREPARING START-UP	6
5. CONNECT THE LINPAC AND WINDOWS PC	8
7. TELENT TO LP-8X4X	10
8. CONFIGURE IP	11
9. TECHNICAL SUPPORT	11

1. Introduction

The LP-8x4x is the flagship compact embedded controller manufactured by ICP DAS. Its leading technology gives you all of the best features of both traditional PLCs and Linux capable PCs. The LP-8x4x system is powered by Linux and brings in the Linux programming style and skill into the world of PC-based PLC. Application developers can develop their own programs directly into C or Java language by using the LP-8x4x SDK, and then download them into the LP-8x4x for application and use.

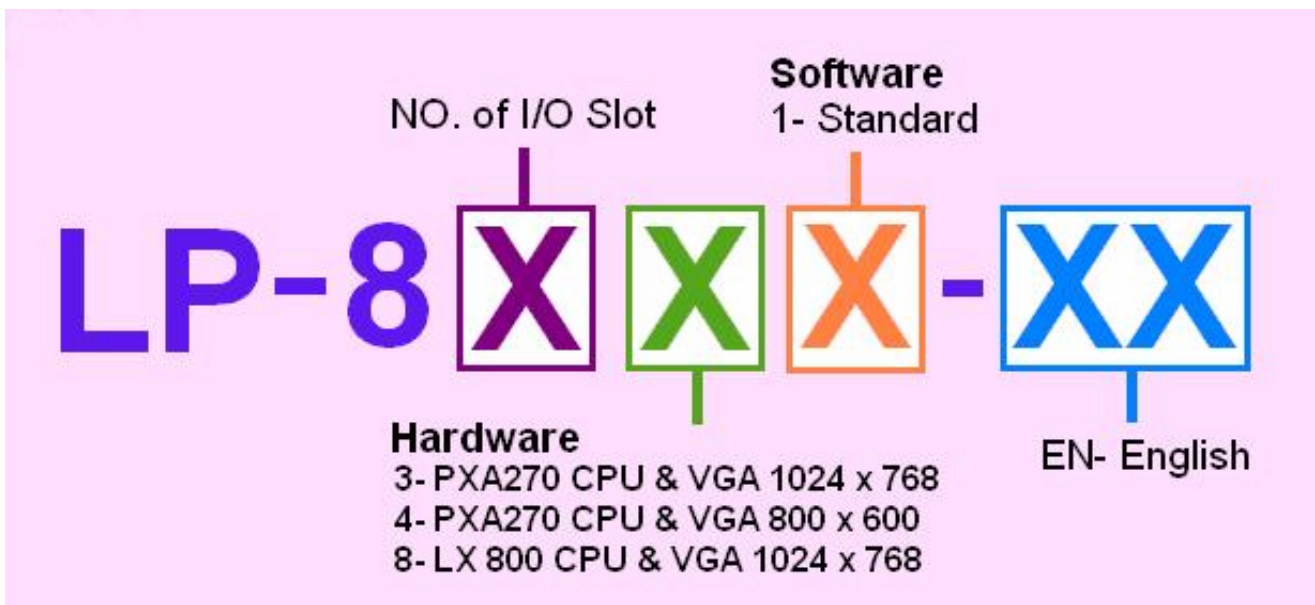

The LP-8x4x model type is shown in the above figure. The Second number shows the slot numbers coming with the main controller unit. Currently, we provide three types of 1、4 and 8 slots. The last number demonstrates the application platform. 1 stands as the Master controller and it means that the user needs to design the application program.

Model		OS	CPU	Flash	SDRAM	Ethernet	VGA Resolution	USB	I/O Slot	Audio Port
NEW	LP-8141	Linux kernel 2.6	PXA270 520 MHz	48 MB	128 MB	2	800 x 600	1	1	None
NEW	LP-8441								4	
NEW	LP-8841								8	

2. Front View

The LP-8x4x Embedded Controller is competitive with Industrial PCs in performance, and is lower in price. The system provides VGA and USB keyboard/mouse for local visualization and management. User control programs and data can be saved in persistent storage via microSD memory card and USB interfaces. Furthermore, it has communication capabilities via the built-in Ethernet and RS-232/RS-485 interfaces

The following figure demonstrates the hardware system in the LP-8x4x. It includes the main controller with HMI, serial communication and I/O expansion interface. COM3 and COM4 is the standard RS-232 interface, which can be connected to the internet via serial port (COM3 or COM4) with the modem. COM2 and COM3 is the RS-485 interface, which can be applied to control the ICP DAS DCON serial modules such as the I-7000W, I-8000W and I-87000W. The FRnet system is an optional control interface.

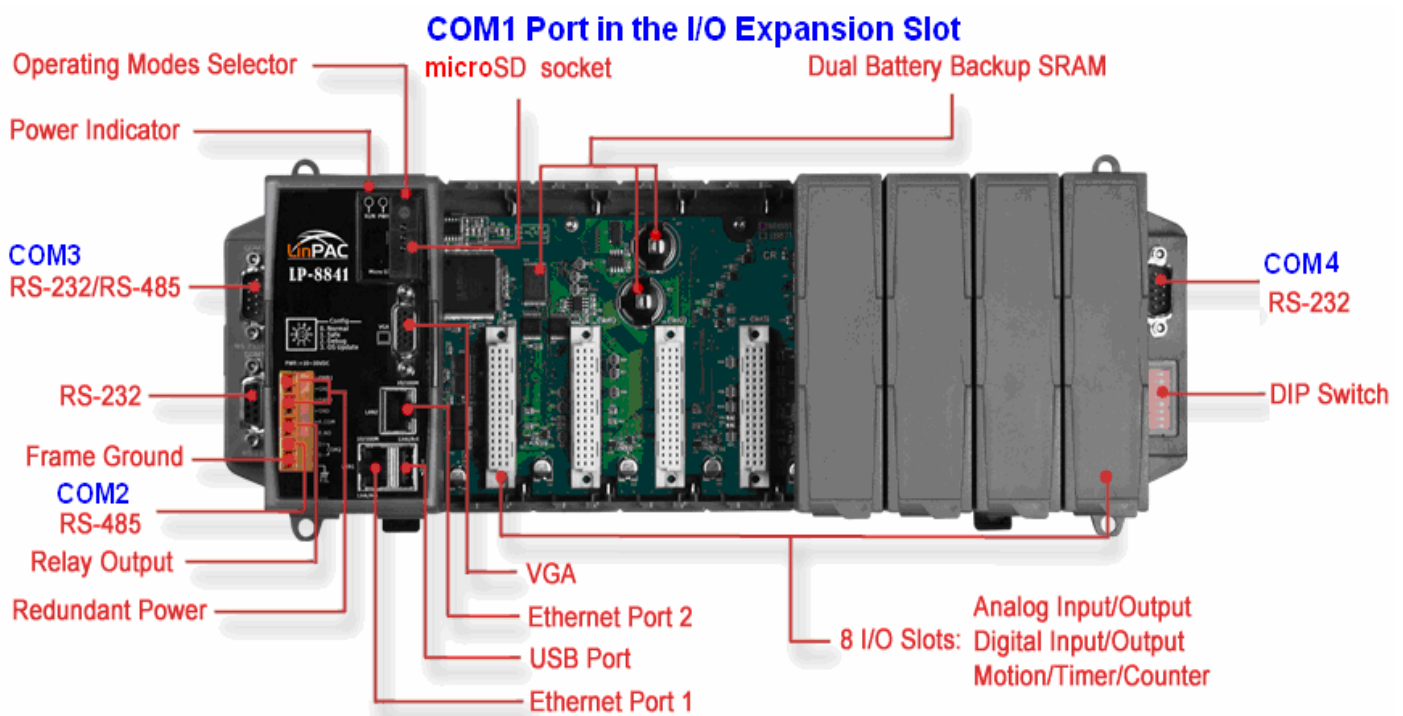

3. Configuring the Operating Mode

There are four basic operation modes for running LP-8x4x that can be determined through a rotary switch. The operating mode selection as below:

	Rotary Switch Position	Operation Mode
	0 : Normal mode	Default
	1 : Quick mode	Quick boot
	2 : OS update mode	Update OS image
	3 : Debug mode	Development by ICP DAS
	Others	Reserved

Normal mode(Default)

Normal mode is the default operation mode for the LP-8x4x. Use this mode to perform additional tasks and configuration. Programs are also executed in this mode.

Quick mode

Quick mode is used to bypass the LP-8x4x boot screen when booting from a microSD/microSDHC card, so as to speed up the booting process.

OS update mode

This mode is used to update the OS image. Note that the Linux OS image is only suitable for the LP-8x4x. If the LP-8x4x cannot be booted or operated in normal mode, use this mode to update OS image again. Ensure that you backup any important files, before updating the OS image. For more information, refer to the “LP-8x4x OS update manual”.

The latest LP-8x4x OS Image: <http://ftp.icpdas.com/pub/cd/linpac/napdos/lp-8x4x/>

Debug mode

This mode is only for use by ICP DAS during development of the device.

Reserved

Rotary switch positions 4~9 are reserved by ICP DAS.

4. Preparing start-up

Step 1: Make sure the rotary switch placed in the '0' position.

Step 2: Plug in your USB keyboard, mouse, microSD card, VGA monitor and LAN.

Step 3: Insert the high profile I-8K/87K series I/O modules into the LP-8x4x slots.

(Only high profile I-8K and I-87K series modules can be plugged)

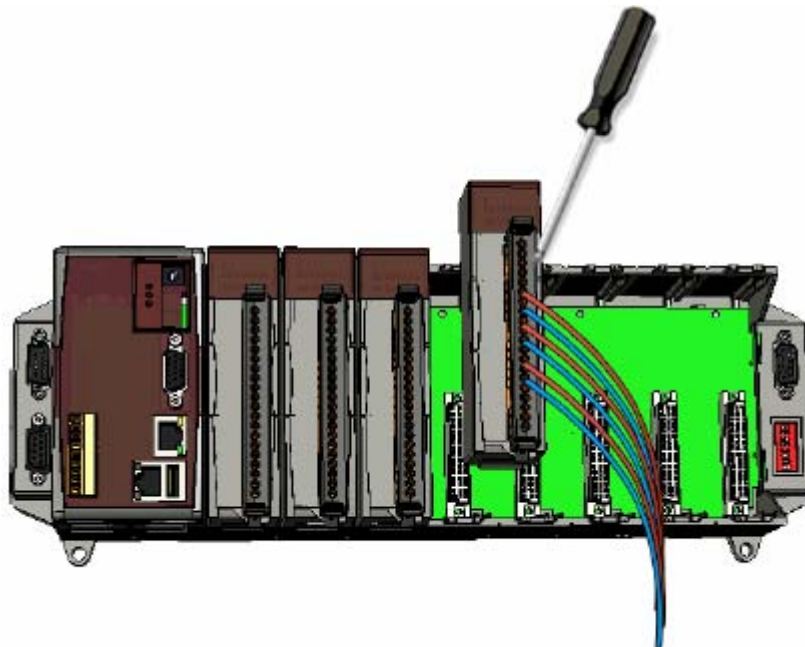
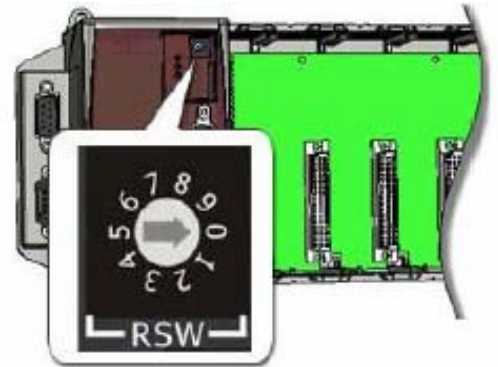

Step 4: Connect the COM2, COM3 or the COM4 ports to your devices controlled if necessary.

Step 5: Connect the DC power and turn it on.

(The input range of power supply is +10 to +30V_{DC})

Step 6: The LP-8x4x will start up, more detail information, refer to the software user's manual for further operations and for developing your own applications.

□ The diagram below shows the connections of LP-8141.

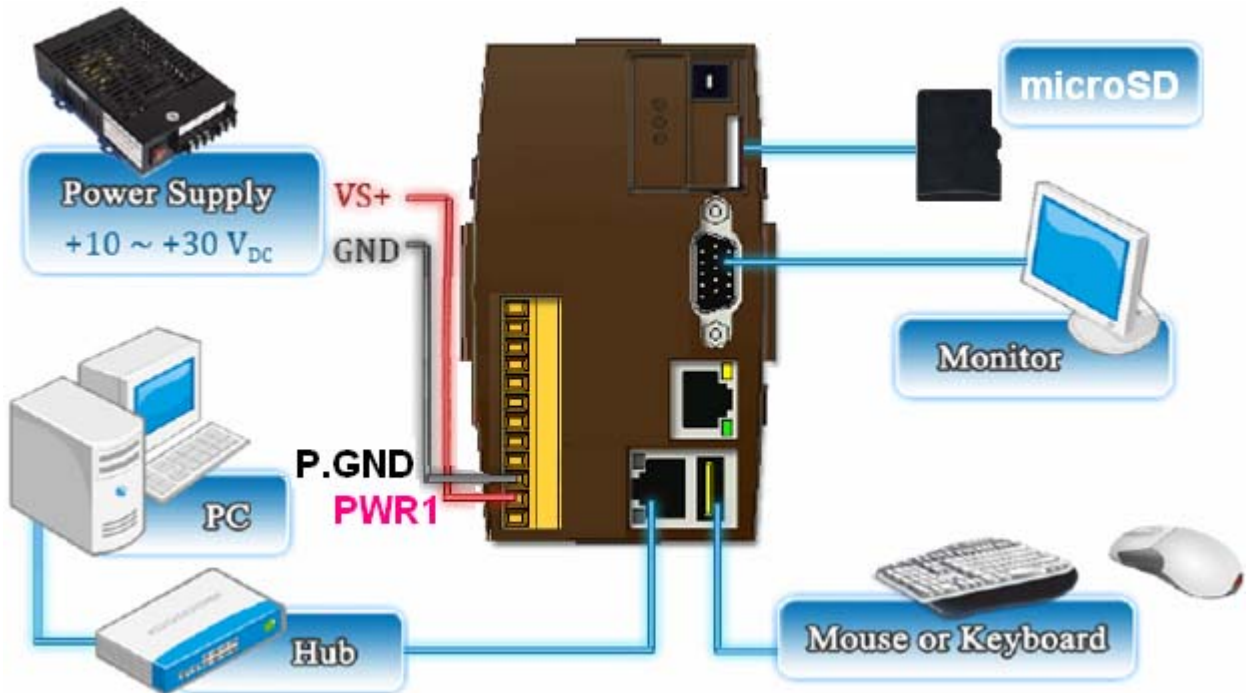

□ The diagram below shows the connections of LP-8441/ LP-8841.

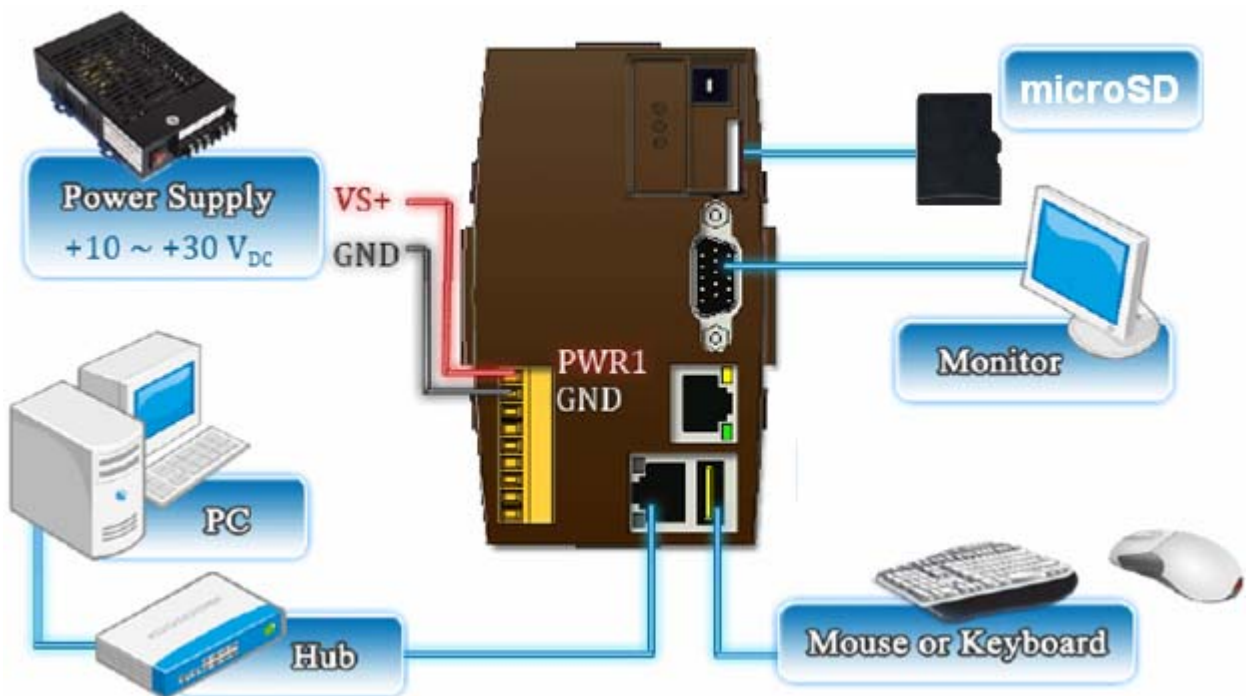

5. Connect the LP-8x4x to a Windows PC

- ➔ Open **HyperTerminal** by clicking on '**Start** → **Programs** → **Accessories** → **Communications** → **Hyper Terminal**'
- ➔ In the 'COM properties' dialog box, set the parameters for COM 1 to **115200 bps, 8 data bits, no parity, 1 stop bit and no flow control**, and then press the OK button to save the settings.
- ➔ **Turn on the LP-8x4x power**, and the following message will be displayed to indicate that the configuration process has been completed.
- ➔ Press 'Enter', you will see 'linpac-8000 login:' prompt.

```
Starting RAM Driver services: 1376 inodes
4096 blocks
Firstdatazone=47 (47)
Zonesize=1024
Maxsize=268966912
Setting the System Clock using the Hardware Clock as reference...
Mon May 18 14:22:38 2009 0.000000 seconds
Mon May 18 14:22:38 UTC 2009
Starting gqcam services: pwc: Philips webcam module version 10.0.12 loaded.
pwc: Supports Philips PCA645/646, PCVC675/680/690, PCVC720[401]/730/740/750 & PCV
C830/840.
pwc: Also supports the Askey VC010, various Logitech Quickcams, Samsung MPC-C10
and MPC-C30,
pwc: the Creative WebCam 5 & Pro Ex, SOTEC Afina Eye and Visionite VCS-UC300 and
VCS-UM100.
usbcore: registered new interface driver Philips webcam
Starting X Server...
/bin/sh: can't access tty; job control turned off
#
icewm-session: using /root/.icewm for private configuration files
icewmbg: using /root/.icewm for private configuration files
IceWM: using /root/.icewm for private configuration files
icewmtray: using /root/.icewm for private configuration files
linpac-8000 login: root
Password:
Distributor ID:      ICP DAS
Description:         LinPAC-8x4x
Release OS:          1.6
Release bootloader:  1.3
Codename:            PACLNX 0.90
Apr  5 15:02:29 login[1230]: root login on 'ttySA0'
installed modules list
slot 1 ... not installed
slot 2 ... 87063
slot 3 ... not installed
slot 4 ... not installed
slot 5 ... not installed
slot 6 ... not installed
slot 7 ... not installed
slot 8 ... not installed
#
```

Default ID and
password is root

6. Connect the LP-8x4x to a Linux PC

- Install HyperTerminal tool on the Linux PC, such as minicom, or gtkterm, etc.
- Using Minicom as an example:
 - In the terminal window, type '**minicom -s**' to enter the Minicom configuration menu. To configure the COM1 port, use the keyboard arrow keys to select the menu item labeled '**Serial port setup**' and then press '**Enter**'. Set the parameters for COM 1 and then press '**Exit**'.

1

```
-----[configuration]-----+
| Filenames and paths          |
| File transfer protocols      |
| Serial port setup          |
| Modem and dialing           |
| Screen and keyboard         |
| Save setup as dfl           |
| Save setup as..             |
| Exit                         |
| Exit from Minicom           |
+-----+

2
```

```
A - Serial Device      : /dev/ttyS0
B - Lockfile Location  : /var/lock
C - Callin Program    :
D - Callout Program   :
E - Bps/Par/Bits     : 115200 8N1
F - Hardware Flow Control : No
G - Software Flow Control : No

Change which setting? [ ]

| Screen and keyboard
| Save setup as dfl
| Save setup as..
| Exit
| Exit from Minicom
+-----+
```

3

```
-----[configuration]-----+
| Filenames and paths          |
| File transfer protocols      |
| Serial port setup           |
| Modem and dialing           |
| Screen and keyboard         |
| Save setup as dfl           |
| Save setup as..             |
| Exit                       |
| Exit from Minicom           |
+-----+
```

4

```
-----+
| Initializing Modem          |
+-----+
```

- A sample of the Minicom operation.

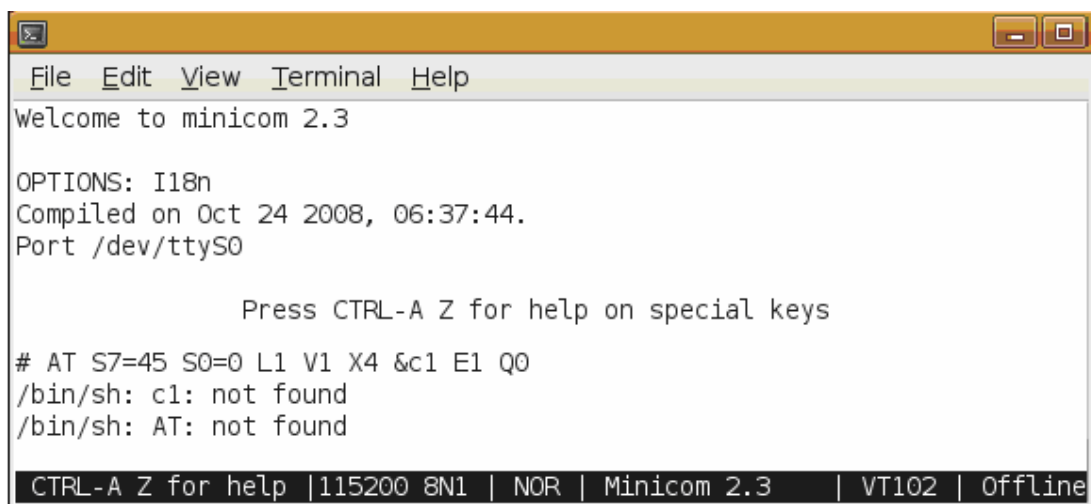

7. Connect to the LP-8x4x via Telnet

➔ To view information about the configured network interfaces with 'ifconfig' cmd:

```
# ifconfig eth0
eth0      Link encap:Ethernet  HWaddr 00:0D:E0:AB:CD:33
          inet addr:10.1.0.8  Bcast:10.1.255.255  Mask:255.255.0.0
          UP BROADCAST RUNNING MULTICAST  MTU:1500  Metric:1
          RX packets:87724 errors:0 dropped:0 overruns:0 frame:0
          TX packets:966 errors:0 dropped:0 overruns:0 carrier:0
          collisions:0 txqueuelen:1000
          RX bytes:0 (0.0 B)  TX bytes:0 (0.0 B)
          Interrupt:41 Base address:0x8000

#
# ifconfig eth1
eth1      Link encap:Ethernet  HWaddr 00:0D:E0:AB:CD:44
          inet addr:10.1.0.17  Bcast:10.1.255.255  Mask:255.255.0.0

          UP BROADCAST RUNNING MULTICAST  MTU:1500  Metric:1
          RX packets:50 errors:0 dropped:0 overruns:0 frame:0
          TX packets:11 errors:0 dropped:0 overruns:0 carrier:0
          collisions:0 txqueuelen:1000
          RX bytes:0 (0.0 B)  TX bytes:0 (0.0 B)
          Interrupt:114 Base address:0xc000

#
```

Use the TCP/IP protocol to establish connection to a remote system.

```
C:\WINDOWS\system32\cmd.exe
C:\Documents and Settings\Cindy>telnet 10.1.0.8
```

1

```

Telnet 10.1.0.8
.LN      _NNNNN  .NNNNN_ .NN      (L      .JNNNNNN
(NN      .NNNF"4F (NN""NNL (NN      .NN      .NNN"4F4F
JN) (NN`      NN) `NN JN)  4NN      .NNN) (N)
NN) .NN)      NN) (NN NN)  NN      .NN4N) (NNL
NN` (NN      (NN_NNN) NN      (NN      NN` NN      `NNNL .
(NN (N)      JNNNNNF` (NN      JNF NN) NN.      4NN)N)
(N)      JNN` JNNNNNNN)      (N)N)
NNL_NNNN` JNF      (NN      .NL_NNN)N)
NNNNN`` (NN      `NN      `NNNNPF4`

Linux embedded controller

linpac-8000 login: root
Password:
Distributor ID:      ICP DAS
Description:         LinPAC-8x4x
Release OS:          1.6
Release bootloader:  1.3
Codename:            PACLNX 0.90

installed modules list
slot 1 ... not installed
slot 2 ... 87063
slot 3 ... not installed
slot 4 ... not installed
slot 5 ... not installed
slot 6 ... not installed
slot 7 ... not installed
slot 8 ... not installed
#
```

8. Configure the IP Address for LP-8x4x

There are two methods of assigning the LP-8x4x network settings. The first uses **DHCP** and the other uses a manually **Assigned IP** address. The factory default setting for the LP-8x4x is DHCP, and this is the easiest method. However, if your network system does not include a DHCP server, then you will need to manually configure the network settings by using the Assigned IP method. To do this:

- Boot the device and establish a connection to the LP-8x4x via Telnet.
- Type in '`vi /etc/network/interfaces`' to open the network setting file.

```
C:\ Telnet 192.168.0.200
auto lo
iface lo inet loopback
# Enable dhcp on eth0
iface eth0 inet dhcp
iface eth1 inet dhcp
iface wlan0 inet dhcp
iface ppp0 inet dhcp

# Or unmark following lines and modify the ip configuration to enable ethernet
#iface eth0 inet static
# address 192.168.0.200
# netmask 255.255.0.0
# gateway 192.168.0.254

~
:wq
```

9. Technical Support

If any of these items are missing or damaged, contact the local distributors for more information. Save the shipping materials and cartons in case you want to ship in the future.



- Our service email account : service@icpdas.com
service.icpdas@gmail.com
- LP-8x4x website:
<http://www.icpdas.com/products/PAC/linpac-8000/introduction.htm>