



Quick Start for CAN-Logger series

Dec 2015, Version 1.0.2

Congratulations!

Congratulations on purchasing CAN-Logger series - the most popular automation solution for CAN Bus data logging. This Quick Start will provide information needed to get started with CAN-Logger series. Please also consult the User Manual for detailed information on the setup and use of CAN-Logger series.

What's In the Box?

In addition to this guide, the package includes the following items:



CAN-Logger100 or
CAN-Logger200



Software Utility CD



USB cable
(CA-USB15)



Screw Driver
(1C016)



microSD
(3LMSD-4000-1)



M12A-5P-IP68 connector
(4PIO1K0000003)



Core
(4SIO1K0000014)

Technical Support

- CAN-Logger series User Manual

CD:\fieldbus_cd\can\can-logger>manual
ftp://ftp.icpdas.com/pub/cd/fieldbus_cd/can/can-logger/manual/

- CAN-Logger series Website

http://www.icpdas.com/root/product/solutions/industrial_communication/fieldbus/can_bu/s/specific_device/can-logger.html

- ICP DAS Website

<http://www.icpdas.com/>

1

Hardware Installation

Before using CAN-Logger device, some things must be done.

Step 1: Prepare one CAN-Logger device

Step 2: Set the CAN baud rate of CAN-Logger device by using rotary switch

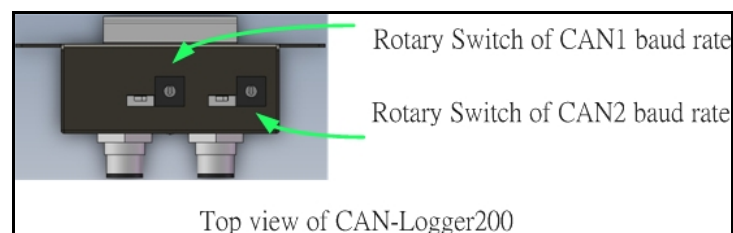
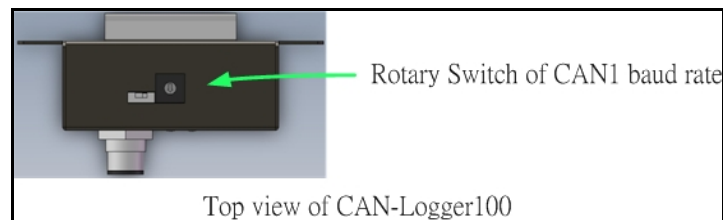

Switch Value	Meaning
0	Set baud rate to 10 kbps
1	Set baud rate to 20 kbps
2	Set baud rate to 50 kbps
3	Set baud rate to 100 kbps
4	Set baud rate to 125 kbps
5	Set baud rate to 250 kbps
6	Set baud rate to 500 kbps
7	Set baud rate to 800 kbps
8	Set baud rate to 1 Mbps
9	Set baud rate to user-defined baud rate which is configured by CAN-Logger utility.
A~E	N/A
F	Set CAN-Logger device into firmware update mode. The firmware update tool is needed.

Step 3: Determine if the terminator resistor is needed or not

Check the application structure, and determine if the terminator resistor is needed or not. You can find it at the position as follows.

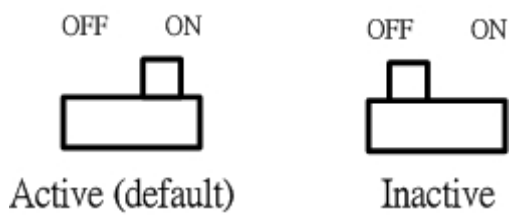
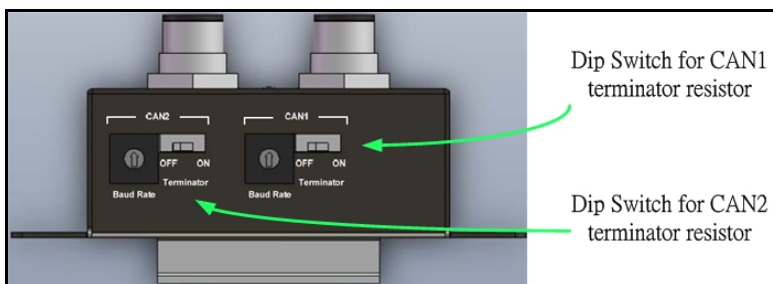
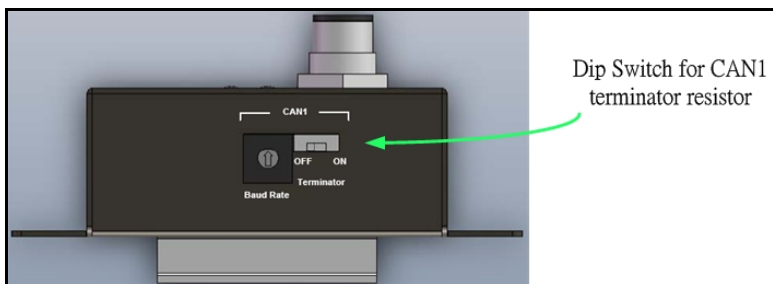

Generally, if your application is as follows, we recommend you to enable the terminator resistor.

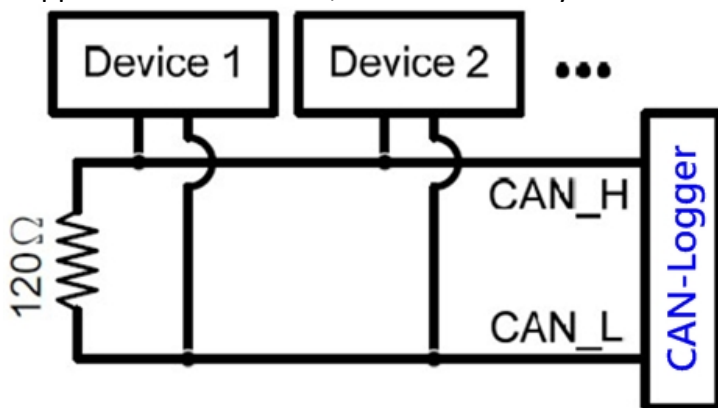

If your application is like the structure as follows, the terminator resistor is not needed.

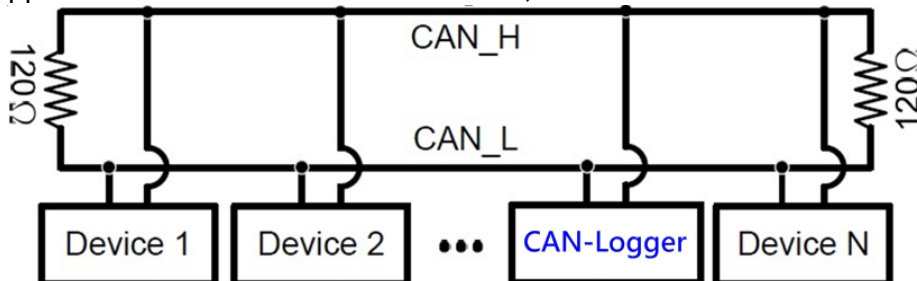

Step 4: Connect the CAN port, power line, frame ground or USB port of the CAN-Logger device.

The pin assignment and wire connection are as follows. When finished, run your application with the CAN-Logger device.

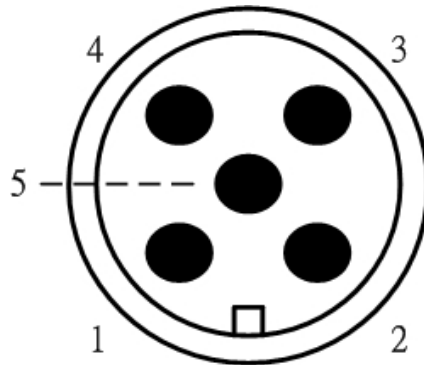

Pin. No.	Name	Meaning
1	F.G.	Frame Ground.
2	+Vs	Voltage Source Input. +10VDC ~ +30VDC.
3	GND	Power Ground.
4	CAN_H	CAN_High, signal line of CAN port.
5	CAN_L	CAN_Low, signal line of CAN port.

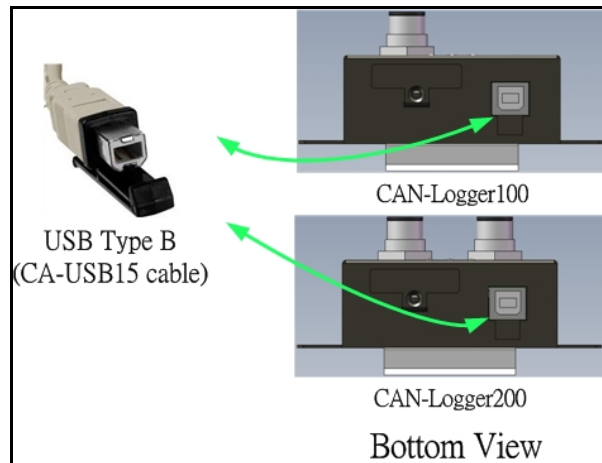
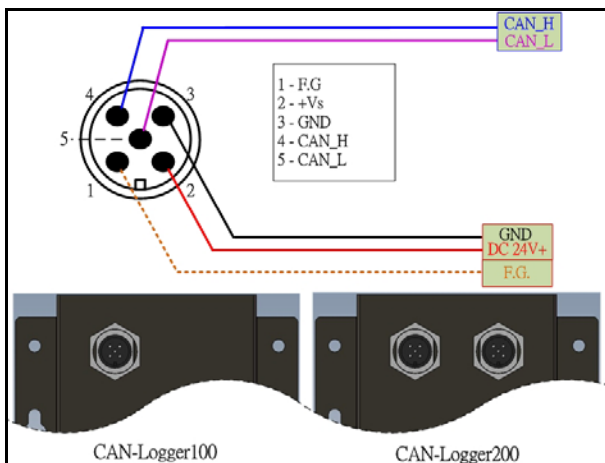

2

Utility tool

When users want to use user-defined CAN baud rate, CAN message filter and diagnostic function on the CAN-Logger series, the CAN-Logger Utility tool may be needed.

Step 1: Install the CAN-Logger Utility

The software is located at:
Fieldbus_CD:\CAN\Converter\CAN-Logger\Software\Utility
http://www.icpdas.com/products/Remote_IO/can_bus/can-logger.htm

Step 2: Setting up the CAN-Logger module

1. Connect the PC available USB port with the USB port of the CAN-Logger device. Users can find the communication cable (CA-USB15) in the product box.

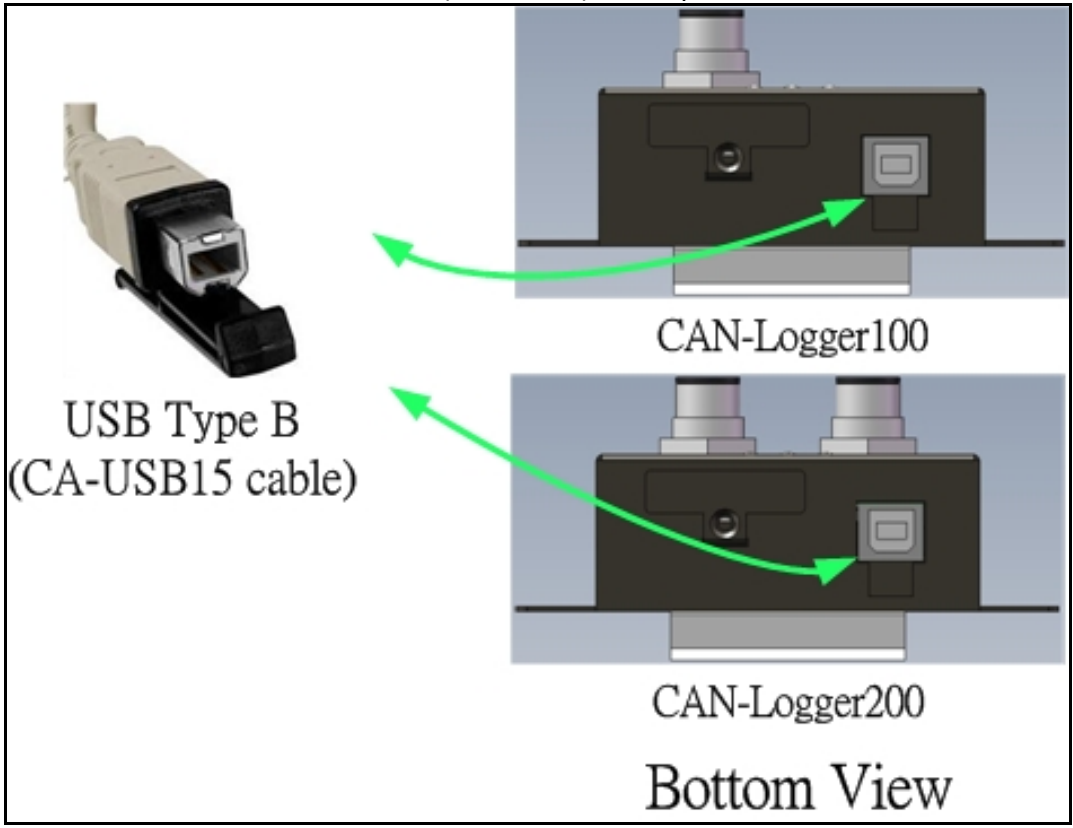

2. Execute the CAN-Logger Utility tool.

Step 3: Configure the CAN-Logger series

When executing the Utility, the tool will try to scan all the necessary CAN-Logger modules and list all scanned module information on the left-bottom of the Utility main frame. User can press the “Refresh” button to re-scan the newer inserted CAN-Logger module.

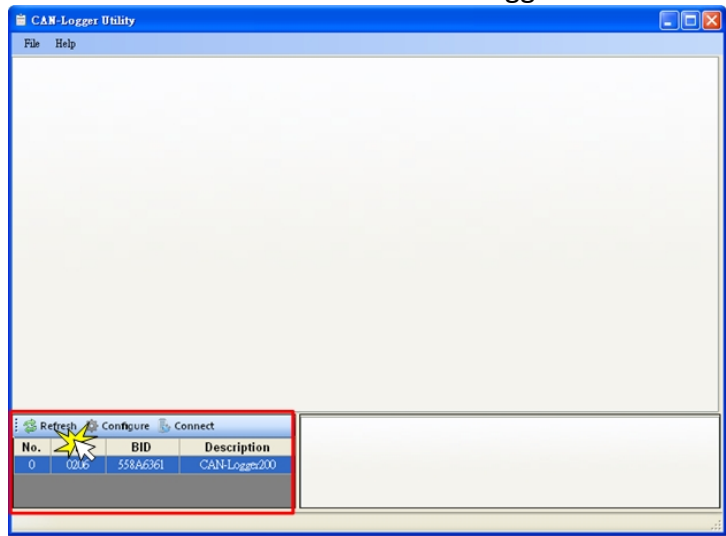

Via the CAN-Logger Utility, user can set the CAN port operation mode and filter parameter of the module. Please refer to the following steps to configure the CAN-Logger series.

1. Select the necessary CAN-Logger module and then press the “Configure” button.



Then the “Device Configuration” window will be popped up.

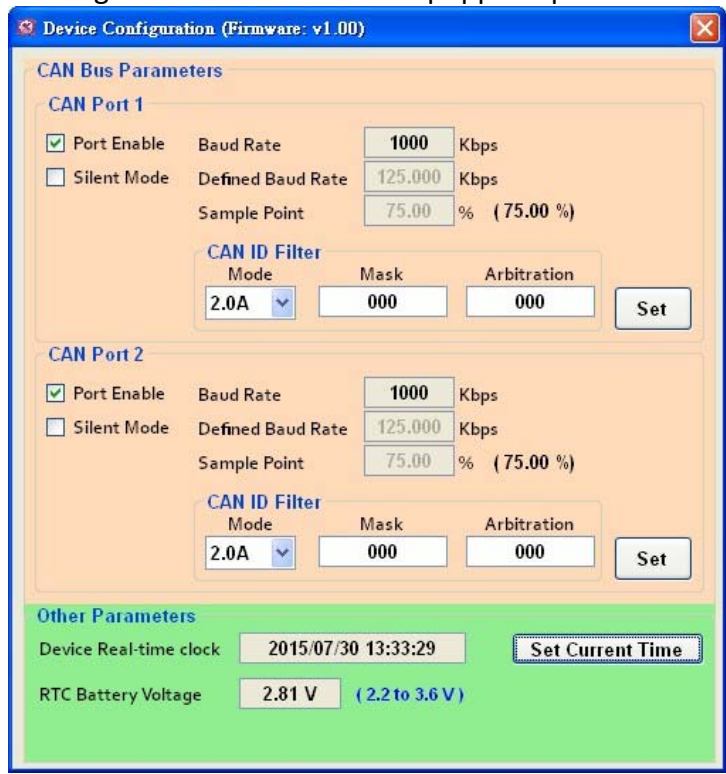

2. On the “Device Configuration” windows, user can set the CAN Bus parameter, and other parameters. The detail functions of these parameters are list below.

[CAN Bus Parameters]

“Port Enable” : Enable/Disable the CAN1/CAN2 port.

“Silent Mode” : Set the CAN port into silent mode. When setting the CAN port into silent mode, the CAN port will just receive CAN messages, no CAN Ack command be sent to the CAN Bus.

“Baud Rate”: CAN Bus baud rate in used. Via setting the ratary switch from ‘0’ ~ ‘8’, user can change the CAN Bus baud rate from ‘10kbps’ to ‘1Mbps’. If you want to use user-defined CAN baud rate, user can set the ratary switch to ‘9’, and then set the “Defined Baud Rate” parameter to the CAN baud rate that you need.

“Defined Baud Rate”: CAN Bus baudrate used for user-defined. After set the CAN rotary switch to ‘9’, you can set this parameter to the baud rate you need.

“Sample Point”: Sample point of CAN baud rate bit timing.

“CAN ID Filter”: CAN message ID filter.

[Mode]: Mode of CAN ID, can be set to 2.0A (11-bit CAN ID) and 2.0B (29-bit CAN ID).

[Mask]: Mask CAN ID bits. Be use with [Arbitration] parameter. Bit value of 0 mean does not care the bit of corresponding “Arbitration CAN ID” and bit value of 1 means this bit need be matched with the corresponding bit of “Arbitration CAN ID”.

[Arbitration]: Arbitration CAN ID bit. The CAN ID that you want to use for the CAN ID filter.

[Example]

1. All CAN ID passed.

[Mode] = “2.0A”

[Mask] = “000”

[Arbitration] = “000”

2. Filter all messages except ID of 0x123.

[Mode] = “2.0A”

[Mask] = “7FF”

[Arbitration] = “123”

3. Filter all messages except ID from 0x100 ~ 0x10F.

[Mode] = “2.0A”

[Mask] = “7F0”

[Arbitration] = “100”

[Other Parameters]

“Device Real-time clock”: RTC time of the CAN-Logger device. This parameter is used for CAN-Logger device to log the received CAN messages into SD card.

“RTC Battery Voltage”: Crrrent battery voltage that RTC used. The battery valtage must be the value between 2.2V_{DC} to 3.6V_{DC}.

Step 4: Transmit, receive CAN messages and check CAN Bus state

By using the CAN-Logger Utility tool, user can transmit, receive CAN messages and check the CAN Bus state of the CAN-Logger devices.

1. Connect with the selected CAN-Logger device.

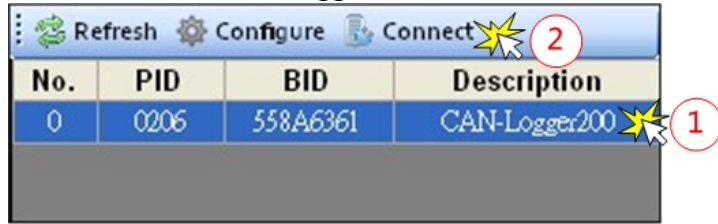

2. Transmit CAN messages, check received CAN messages and CAN Bus state.

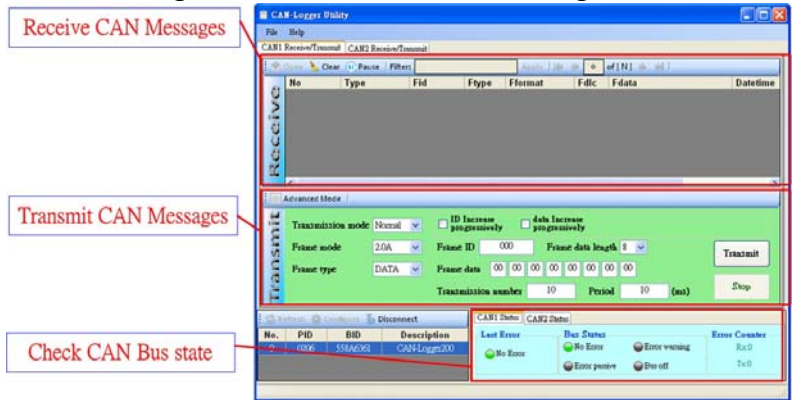

3

Core's application and wiring

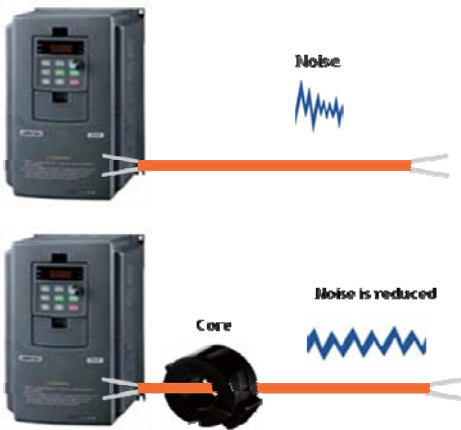

Core(Ferrite) is useful to reduce ElectroMagnetic Interference(EMI) and anti-noise, it mainly uses for communication interface like CAN Bus and DC power supply line.

The below photos are the wiring of the core on CAN Bus side.

